



Test Report issued under the responsibility of:



**TEST REPORT
IEC 62368-1
Audio/video, information and communication technology equipment
Part 1: Safety requirements**

Report Number..... : 240100039SHA-001
Date of issue : 2024-02-29
Total number of pages : 181

Name of Testing Laboratory preparing the Report : Intertek Testing Services Shanghai

Applicant's name : GlobTek, Inc
Address : 186 Veterans Dr. Northvale, NJ 07647 USA

Test specification:

Standard : IEC 62368-1:2018
Test procedure..... : CB Scheme
Non-standard test method..... : N/A

TRF template used : IECEE OD-2020-F1:2021, Ed.1.4
Test Report Form No..... : IEC62368_1E
Test Report Form(s) Originator.... : UL(US)
Master TRF : Dated 2022-04-14

Copyright © 2022 IEC System of Conformity Assessment Schemes for Electrotechnical Equipment and Components (IECEE System). All rights reserved.

This publication may be reproduced in whole or in part for non-commercial purposes as long as the IECEE is acknowledged as copyright owner and source of the material. IECEE takes no responsibility for and will not assume liability for damages resulting from the reader's interpretation of the reproduced material due to its placement and context.

If this Test Report Form is used by non-IECEE members, the IECEE/IEC logo and the reference to the CB Scheme procedure shall be removed.

This report is not valid as a CB Test Report unless signed by an approved CB Testing Laboratory and appended to a CB Test Certificate issued by an NCB in accordance with IECEE 02.

General disclaimer:

The test results presented in this report relate only to the object tested.
This report shall not be reproduced, except in full, without the written approval of the Issuing CB Testing Laboratory. The authenticity of this Test Report and its contents can be verified by contacting the NCB, responsible for this Test Report.

Test item description	ITE/ ICT POWER SUPPLY	
Trade Mark(s)		
Manufacturer	Same as applicant	
Model/Type reference	GT*961200P****, GT*96900P**** and GT*41133-**** (Refer to page 8-9 for details.)	
Ratings	Input: 100-240V~, 50-60Hz, 1.5A; Output: Refer to page 9 for details.	
Responsible Testing Laboratory (as applicable), testing procedure and testing location(s):		
<input checked="" type="checkbox"/>	CB Testing Laboratory:	Intertek Testing Services Shanghai
Testing location/ address	Building No. 86, 1198 Qinzhou Road (North) 200233 Shanghai CHINA	
Tested by (name, function, signature)	Leo Li (Engineer)	<i>leo li</i>
Approved by (name, function, signature) .. :	Hans Wang (Mandated Reviewer)	<i>Hans Wang</i>
<input type="checkbox"/>	Testing procedure: CTF Stage 1:	
Testing location/ address		
Tested by (name, function, signature)		
Approved by (name, function, signature) .. :		
<input type="checkbox"/>	Testing procedure: CTF Stage 2:	
Testing location/ address		
Tested by (name, function, signature)		
Witnessed by (name, function, signature) . :		
Approved by (name, function, signature) .. :		
<input type="checkbox"/>	Testing procedure: CTF Stage 3:	
<input type="checkbox"/>	Testing procedure: CTF Stage 4:	
Testing location/ address		
Tested by (name, function, signature)		
Witnessed by (name, function, signature) . :		
Approved by (name, function, signature) .. :		
Supervised by (name, function, signature) :		

<p>List of Attachments (including a total number of pages in each attachment):</p> <p>Appendix No.1: Photos of product; from page 89 to 109, total 21 pages. Appendix No.2: Group differences for the CENELEC: from page 110 to 136, total 27 pages. Appendix No.3: National differences for USA and Canada: from page 137 to 144, total 8 pages. Appendix No.4: National differences for Australia and New Zealand: from page 145 to 175, total 31 pages. Appendix No.5: National differences for Japan: from page 176 to 181, total 6 pages.</p>	
<p>Summary of testing:</p> <p>From the result of our examination and tests in the submitted samples, conclude they comply with the requirements of the standard IEC 62368-1:2018 (Third Edition).</p>	
<p>All applicable tests as described in Test Case and Measurement Sections were performed. Maximal ambient temperature as specified by the manufacturer: +40°C 5.2 Classification and limits of electrical energy sources 5.3.2 Accessibility to electrical energy sources and safeguards 5.4.1.4 Maximum operating temperatures for materials, components and systems 5.4.1.8 Determination of working voltage 5.4.1.10.3 Ball pressure test 5.4.2 Clearances 5.4.3 Creepage distances 5.4.8 Humidity conditioning 5.4.9 Electric strength test 5.6.6.2 Grounding continuity test 5.7.2.1 Measurement of touch current 6.2.2.2 Power measurement for worst-case load fault 6.2.2.3 Power measurement for worst-case source fault 6.4.3.3 Single Fault Conditions test 6.4.8 Fire enclosure and fire barriers B.2.5 Input test B.3.5 Maximum load at output terminals B.4 Simulated single fault conditions F.3.10 Permanence of markings G.5.3.3 Overload test of Transformers Q.1.2 Limited power sources T.2 Steady force test, 10 N T.4 Steady force test, 100 N T.7 Drop test T.8 Stress relief test</p>	<p>Testing location:</p> <p>Intertek Testing Services Shanghai Building No.86, 1198 Qinzhou Road (North), 200233 Shanghai, China</p>

Summary of compliance with National Differences (List of countries addressed):

Group difference for CENELEC countries and national differences USA and Canada, Japan, Australia and New Zealand are considered.

The product fulfils the requirements of EN IEC 62368-1:2020+A11:2020.

Use of uncertainty of measurement for decisions on conformity (decision rule) :

No decision rule is specified by the IEC standard, when comparing the measurement result with the applicable limit according to the specification in that standard. The decisions on conformity are made without applying the measurement uncertainty ("simple acceptance" decision rule, previously known as "accuracy method").

Other:... (to be specified, for example when required by the standard or client, or if national accreditation requirements apply)

Information on uncertainty of measurement:

The uncertainties of measurement are calculated by the laboratory based on application of criteria given by OD-5014 for test equipment and application of test methods, decision sheets and operational procedures of IECEE.

IEC Guide 115 provides guidance on the application of measurement uncertainty principles and applying the decision rule when reporting test results within IECEE scheme, noting that the reporting of the measurement uncertainty for measurements is not necessary unless required by the test standard or customer.

Calculations leading to the reported values are on file with the NCB and testing laboratory that conducted the testing.

Copy of marking plate:

The artwork below may be only a draft. The use of certification marks on a product must be authorized by the respective NCBS that own these marks.

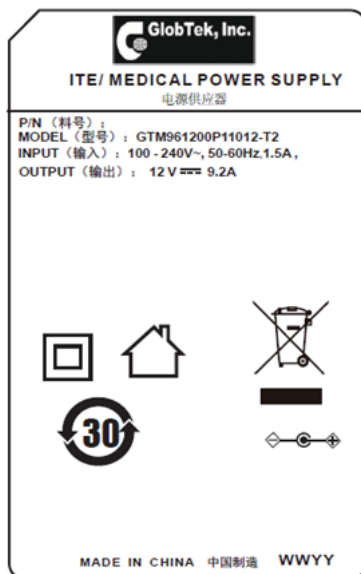
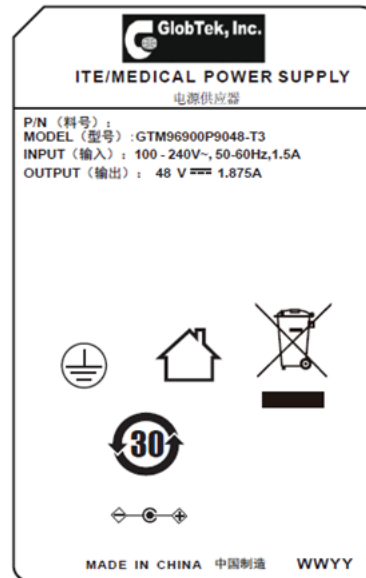
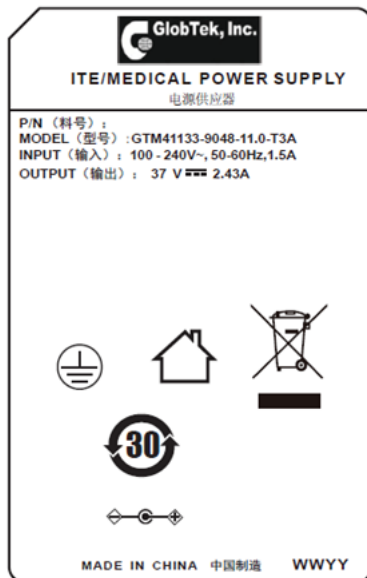
**Remark:**

The above markings are the minimum requirements required by the safety standard. For the final production samples, the additional markings which do not give rise to misunderstanding may be added.

Other models are with similar label as corresponding above models except different model name and output ratings.

When the equipment is vended to EU, the name and address of the importer or authorized representative within the EEA shall be added on the equipment;

Test item particulars:	
Product group	<input checked="" type="checkbox"/> end product <input type="checkbox"/> built-in component
Classification of use by	<input checked="" type="checkbox"/> Ordinary person <input type="checkbox"/> Children likely present <input type="checkbox"/> Instructed person <input type="checkbox"/> Skilled person
Supply connection	<input checked="" type="checkbox"/> AC mains <input type="checkbox"/> DC mains <input type="checkbox"/> not mains connected: <input type="checkbox"/> ES1 <input type="checkbox"/> ES2 <input checked="" type="checkbox"/> ES3
Supply tolerance	<input checked="" type="checkbox"/> +10%/-10% <input type="checkbox"/> +20%/-15% <input type="checkbox"/> + %/ - % <input type="checkbox"/> None
Supply connection – type	<input checked="" type="checkbox"/> pluggable equipment type A - <input checked="" type="checkbox"/> non-detachable supply cord <input checked="" type="checkbox"/> appliance coupler <input type="checkbox"/> direct plug-in <input type="checkbox"/> pluggable equipment type B - <input type="checkbox"/> non-detachable supply cord <input type="checkbox"/> appliance coupler <input type="checkbox"/> permanent connection <input type="checkbox"/> mating connector <input checked="" type="checkbox"/> other: building-in equipment shall be evaluated in end system (see also general product information).
Considered current rating of protective device	<input checked="" type="checkbox"/> 16 A (20A for Noth America); Location: <input checked="" type="checkbox"/> building <input type="checkbox"/> equipment <input type="checkbox"/> N/A
Equipment mobility	<input type="checkbox"/> movable <input type="checkbox"/> hand-held <input checked="" type="checkbox"/> transportable <input type="checkbox"/> direct plug-in <input type="checkbox"/> stationary <input checked="" type="checkbox"/> for building-in <input type="checkbox"/> wall/ceiling-mounted <input type="checkbox"/> SRME/rack-mounted <input type="checkbox"/> other:
Overvoltage category (OVC)	<input type="checkbox"/> OVC I <input checked="" type="checkbox"/> OVC II <input type="checkbox"/> OVC III <input type="checkbox"/> OVC IV <input type="checkbox"/> other:
Class of equipment	<input checked="" type="checkbox"/> Class I <input checked="" type="checkbox"/> Class II <input type="checkbox"/> Class III <input type="checkbox"/> Not classified <input type="checkbox"/>
Special installation location	<input checked="" type="checkbox"/> N/A <input type="checkbox"/> restricted access area <input type="checkbox"/> outdoor location <input type="checkbox"/>
Pollution degree (PD)	<input type="checkbox"/> PD 1 <input checked="" type="checkbox"/> PD 2 <input type="checkbox"/> PD 3
Manufacturer's specified T_{ma}	40°C <input type="checkbox"/> Outdoor: minimum °C
IP protection class	<input checked="" type="checkbox"/> IPX0 <input type="checkbox"/> IP__
Power systems	<input checked="" type="checkbox"/> TN <input type="checkbox"/> TT <input type="checkbox"/> IT - V _{L-L} <input type="checkbox"/> not AC mains
Altitude during operation (m)	<input type="checkbox"/> 2000 m or less <input checked="" type="checkbox"/> <5000 m
Altitude of test laboratory (m)	<input type="checkbox"/> 2000 m or less <input checked="" type="checkbox"/> <50 m
Mass of equipment (kg)	Approx. 0.48kg (For model: GT*41133 series) Approx. 0.40kg (For model: GT*96900P series, GT*961200P series)

Possible test case verdicts:	
- test case does not apply to the test object: N/A	
- test object does meet the requirement.....: P (Pass)	
- test object does not meet the requirement.....: F (Fail)	
Testing:	
Date of receipt of test item: 2024-01-02	
Date (s) of performance of tests: 2024-01-02 to 2024-02-24	
General remarks:	
<p>"(See Enclosure #)" refers to additional information appended to the report. "(See appended table)" refers to a table appended to the report.</p> <p>Throughout this report a <input type="checkbox"/> comma / <input checked="" type="checkbox"/> point is used as the decimal separator. When determining for test conclusion, measurement uncertainty of tests has been considered.</p> <p>Through the report, models GTM41133-9016-4.0-T2, GTM41133-9048-11.0-T2, GTM41133-9048-10.5-T2, GTM96900P9012-T2, GTM96900P9015-T3, GTM96900P9054-T2, GTM961200P11112-T3, GTM961200P12015-T3 and GTM961200P12054-T2 were tested as typical models for all tests. Input test was also performed on GTM96900P9024-T2 and GTM96900P9024-T3.</p> <p>Disclaimer:</p> <p>This report is for the exclusive use of Intertek's Client and is provided pursuant to the agreement between Intertek and its Client. Intertek's responsibility and liability are limited to the terms and conditions of the agreement. Intertek assumes no liability to any party, other than to the Client in accordance with the agreement, for any loss, expense or damage occasioned by the use of this report. Only the Client is authorized to permit copying or distribution of this report and then only in its entirety. Any use of the Intertek name or one of its marks for the sale or advertisement of the tested material, product or service must first be approved in writing by Intertek. The observations and test results in this report are relevant only to the sample tested. This report by itself does not imply that the material, product, or service is or has ever been under an Intertek certification program.</p> <p>The test report only allows to be revised only within the report defined retention period unless standard or regulation was withdrawn or invalid.</p>	
Manufacturer's Declaration per sub-clause 4.2.5 of IECCE 02:	
The application for obtaining a CB Test Certificate includes more than one factory location and a declaration from the Manufacturer stating that the sample(s) submitted for evaluation is (are) representative of the products from each factory has been provided	<input checked="" type="checkbox"/> Yes <input type="checkbox"/> Not applicable
When differences exist; they shall be identified in the General product information section.	
Name and address of factory (ies)	1. GlobTek, Inc. 186 Veterans Dr. Northvale, NJ 07647 USA 2. GlobTek (Suzhou) Co., Ltd. Building 4, No. 76 JinLing East Road, Suzhou Industrial Park, Suzhou, JiangSu, 215021, China

General product information and other remarks:

Product covered by this report is ITE power supply module.

One type is power adapter, which can be used with detachable power supply cord. Different appliance inlets can be interchangeable on the device, which can provide earthing connection or not. Protective earthing connection to secondary circuit by internal wiring is optional, so it can be Class I or Class II construction or Class II with functional earth. Both two constructions are in consideration in this report. Two pieces of outer enclosure are enclosed with ultrasonic welding and screws.

The other type is open-frame power supply board, which is the same as adapter model except input and output terminals and traces on the board. The installation and use for the insulation construction shall be finally determined in the end product.

The products were tested to be suitable for connection to ≤ 16 A (IEC) and ≤ 20 A (USA) branch circuit in series. The unit is approved for TN mains star connections. The unit provides internally two fuse locations, the first fuse F1 or FS1 is required, the second fuse F2 or FS2 is optional.

All the types are designed for continuous operation.

The products are not intended to be used in maximum ambient temperature exceed of 40 °C

The products are not intended to use in environment which altitude exceed 5000m.

Model Similarity:

GT*961200P****, GT*96900P**** and GT*41133-*****

The 1st "*" part can be 'M' or '-' or 'H' for market identification and not related to safety.

When model = GT*41133-*****

The 2nd "*" denotes the rated output wattage designation, which can be "01" to "90", with interval of 1.

The 3rd "*" denotes the standard rated output voltage designation, which can be "16", "24", "35" and "48".

The 4th "*" part is optional, which can be "-0.1" to "-12.9" with interval of 0.1 to denote voltage deviation or blank to indicate no voltage different.

The 3rd "*" and 4th "*" together denote the output voltage, with a range of 12 - 48 volts

The 5th "*" =-T2 means desktop class II with C8 AC inlet

=-T3A means desktop class I or class II with functional earth with C6 AC inlet

=-F means Open Frame class I or class II with functional earth

=-FW means Open Frame class II

The last * denote any six character = 0-9 or A-Z or ([]) or – or blank for marketing purposes.

When model = GT*961200P** and GT*96900P******

The 2nd "*" denotes the rated output wattage designation, which can be "-01" to "-120", with interval of 1 and "-" can be omitted.

The 3rd "*" denote the standard rated output voltage designation, which can be "12" to "54" or "12.0" to "54.0" in 0.1V increments

The 4th "*" =-T2 means desktop class II with C8 AC inlet

=-T2A means desktop class II with C18 AC inlet

=-T3 means desktop class I or class II with functional earth with C14 AC inlet

=-T3A means desktop class I or class II with functional earth with C6 AC inlet

=-T3TAB means desktop class I or class II with functional earth with C14 AC inlet and housing with a tab.

=-TW means desktop class II with input wire without plug

=-TW3 means desktop class I or class II with functional earth with input wire without plug

=-TP means desktop class II with power supply cord with plug

=-TP3 means desktop class I or class II with functional earth with power supply cord with plug

=-P2 means Encapsulated Type, class II, with two-core input wire, IP68

=-P3 means Encapsulated Type, class I or class II with functional earth, with three-core input wire, IP68

The last * denote any six character = 0-9 or A-Z or ([]) or – or blank for marketing purposes.

Ratings:

When model = GT*41133-****, Input: 100-240V~, 50-60Hz, 1.5A; Output: 12-48Vdc, Max. 7.5A, Max. 90W

When model = GT*96900P****, Input: 100-240V~, 50-60Hz, 1.5A; Output: 12-54Vdc, Max. 7.5A, Max. 90W

When model = GT*961200P****, Input: 100-240V~, 50-60Hz, 1.5A; Output: 12-54Vdc, Max. 9.2A, Max. 120W

Model list:

GT*41133-**** Desktop models and open frame models

Model	Rated output voltage range	Max. rated output current	Max. rated output power
GTM41133-*16*-T2/T3A/F/FW*	12-16Vdc	7.5A	90W
GTM41133-*24*-T2/T3A/F/FW*	16.1-24Vdc	5.6A	90W
GTM41133-*35*-T2/T3A/F/FW*	24.1-35Vdc	3.73A	90W
GTM41133-*48*-T2/T3A/F/FW*	35.1-48Vdc	2.56A	90W

GT*961200P**** and GT*96900P**** Desktop models

Model	Rated output voltage range	Max. rated output current	Max. rated output power
GT*96900P**- T2/T2A/T3/T3A/T3TAB/TW/TW 3/TP/TP3/P2/P3*	12-54Vdc	7.5A	90W
GT*961200P**- T2/T2A/T3/T3A/T3TAB/TW/TW 3/TP/TP3/P2/P3*	12-14.9Vdc	9.2A	111W
GT*961200P**- T2/T2A/T3/T3A/T3TAB/TW/TW 3/TP/TP3/P2/P3*	15-54Vdc	8A	120W

OVERVIEW OF ENERGY SOURCES AND SAFEGUARDS				
Clause	Possible Hazard			
5	Electrically-caused injury			
Class and Energy Source (e.g. ES3: Primary circuit)	Body Part (e.g. Ordinary)	Safeguards		
		B	S	R
ES3: primary circuit	Ordinary	N/A	N/A	Enclosure
ES1: Output circuit	Ordinary	N/A	N/A	N/A
6	Electrically-caused fire			
Class and Energy Source (e.g. PS2: 100 Watt circuit)	Material part (e.g. Printed board)	Safeguards		
		B	1 st S	2 nd S
PS3: Primary circuit and secondary circuit inside the enclosure	Combustible materials within equipment	Normal temperature below ignition temperature	Fire enclosure; fire barrier; Suitable component and material used	N/A
PS2: Output circuit	Output connector and all parts outside Fire enclosure	Normal temperature below ignition temperature	Suitable component and material used	N/A
7	Injury caused by hazardous substances			
Class and Energy Source (e.g. Ozone)	Body Part (e.g., Skilled)	Safeguards		
		B	S	R
N/A	N/A	N/A	N/A	N/A
8	Mechanically-caused injury			
Class and Energy Source (e.g. MS3: Plastic fan blades)	Body Part (e.g. Ordinary)	Safeguards		
		B	S	R
MS1: Edges and corners	Ordinary	N/A	N/A	N/A
MS1: Mass of the unit	Ordinary	N/A	N/A	N/A
9	Thermal burn			
Class and Energy Source (e.g. TS1: Keyboard caps)	Body Part (e.g., Ordinary)	Safeguards		
		B	S	R
TS1: Plastic enclosure	Ordinary	N/A	N/A	N/A
10	Radiation			
Class and Energy Source (e.g. RS1: PMP sound output)	Body Part (e.g., Ordinary)	Safeguards		
		B	S	R
N/A	N/A	N/A	N/A	N/A
Supplementary Information:				

“B” – Basic Safeguard; “S” – Supplementary Safeguard; “R” – Reinforced Safeguard

ENERGY SOURCE DIAGRAM

Optional. Manufacturers are to provide the energy sources diagram identify declared energy sources and identifying the demarcations are between power sources. Recommend diagram be provided included in power supply and multipart systems.

Insert diagram below. Example diagram designs are; Block diagrams; image(s) with layered data; mechanical drawings

ES3: Primary circuit (GTM41133)

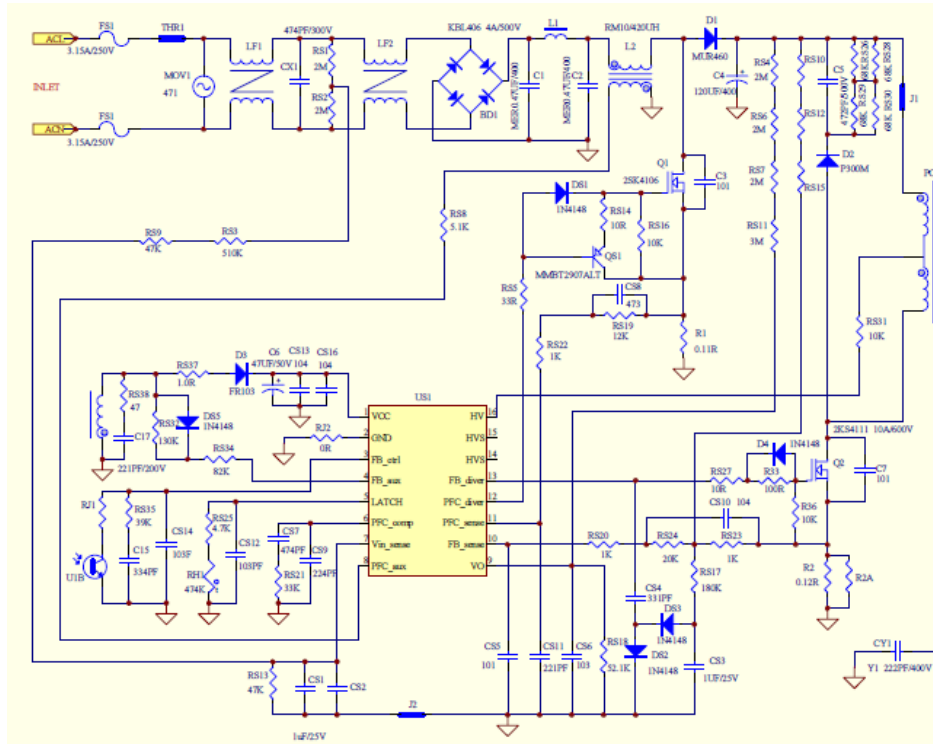

ES3: Primary circuit (GTM96900 and GTM961200P)

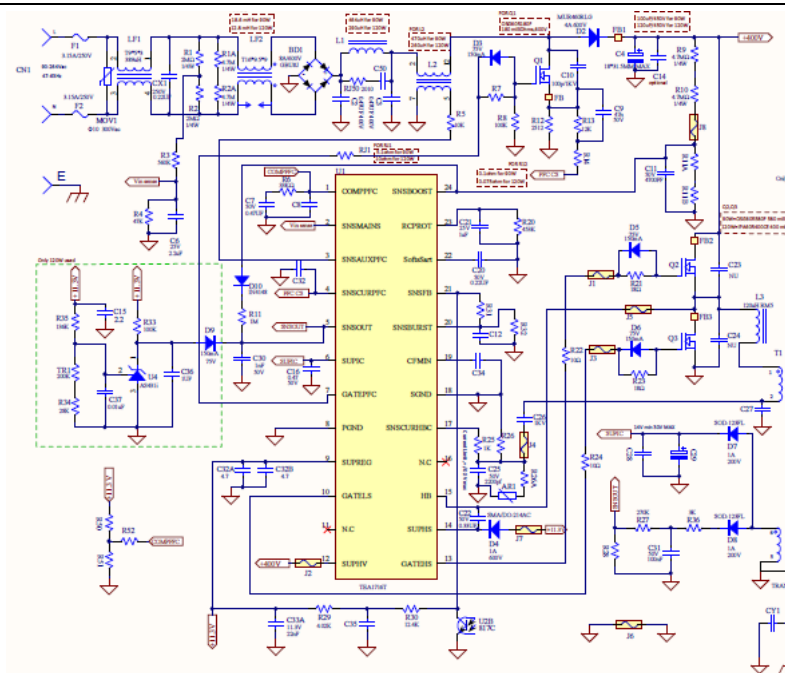

ES1: Secondary circuit (GTM41133)

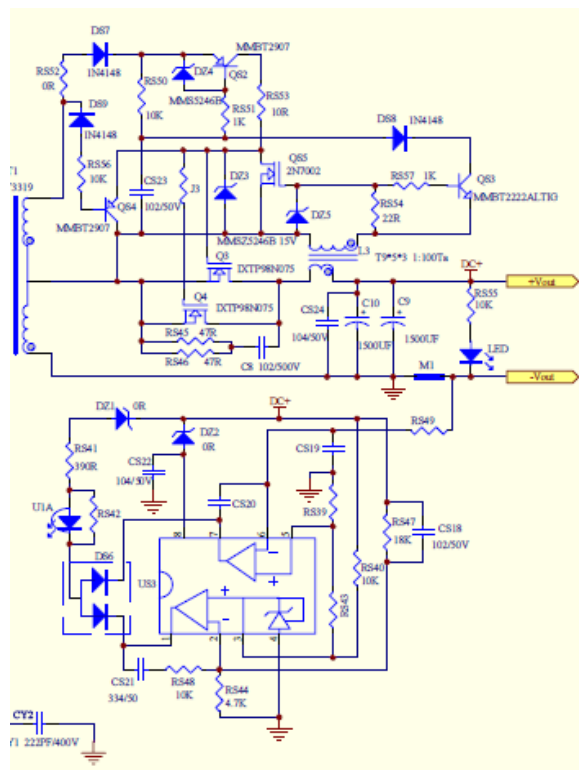

ES1: Secondary circuit (GTM96900 and GTM961200P)

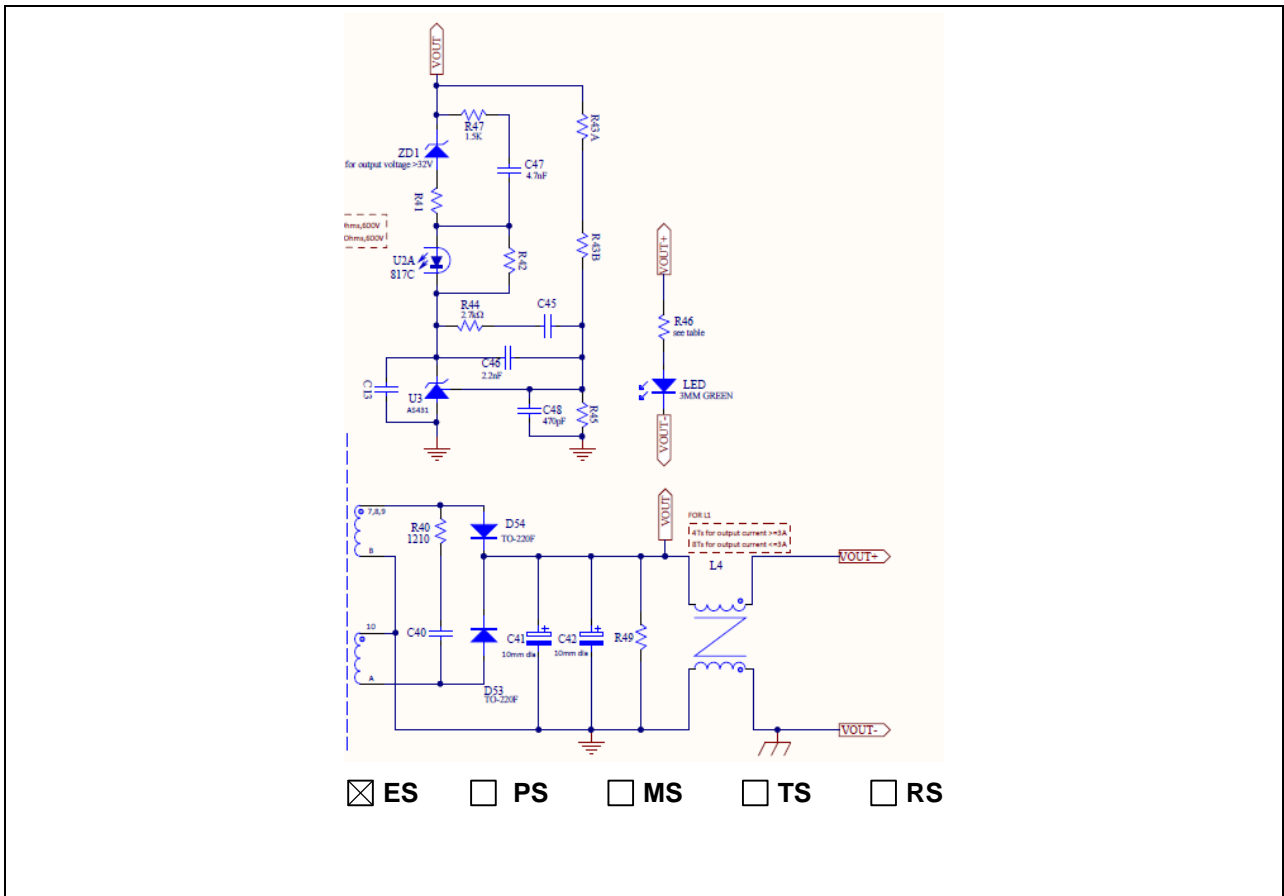

IEC 62368-1			
Clause	Requirement + Test	Result - Remark	Verdict
4	GENERAL REQUIREMENTS		P
4.1.1	Acceptance of materials, components and subassemblies	See appended table 4.1.2	P
4.1.2	Use of components	Components which are certified to IEC and/or national standards are used correctly within their ratings. Components not covered by IEC standards are tested under the conditions present in the equipment. See also Annex G	P
4.1.3	Equipment design and construction	Evaluation of safeguards regarding limiting the outputs to fulfill ES1, and protection in regard to risk of ignition, mechanical-caused injury and thermal burn considered.	P
4.1.4	Specified ambient temperature for outdoor use (°C) :		N/A
4.1.5	Constructions and components not specifically covered		N/A
4.1.8	Liquids and liquid filled components (LFC)	(See G.15)	N/A
4.1.15	Markings and instructions	(See Annex F)	P
4.4.3	Safeguard robustness	See below.	P
4.4.3.1	General		P
4.4.3.2	Steady force tests	(See Clause T.3, T.4, T.5)	P
4.4.3.3	Drop tests	(See Annex T.7)	P
4.4.3.4	Impact tests		N/A
4.4.3.5	Internal accessible safeguard tests	The external enclosure cannot be opened without damaging the product.	N/A
4.4.3.6	Glass impact tests	(See Clause T.9, Annex U)	N/A
4.4.3.7	Glass fixation tests		N/A
	Glass impact test (1J)		N/A
	Push/pull test (10 N)		N/A
4.4.3.8	Thermoplastic material tests	(See Annex T.8)	P
4.4.3.9	Air comprising a safeguard	(See Annex T)	P
4.4.3.10	Accessibility, glass, safeguard effectiveness	After tests of 4.4.4.2, 4.4.4.3, 4.4.4.7, no safeguard damaged.	P

IEC 62368-1			
Clause	Requirement + Test	Result - Remark	Verdict
4.4.4	Displacement of a safeguard by an insulating liquid		N/A
4.4.5	Safety interlocks	(See Annex K)	N/A
4.5	Explosion		N/A
4.5.1	General	(See Annex M for batteries)	N/A
4.5.2	No explosion during normal/abnormal operating condition	(See Clause B.2, B.3)	N/A
	No harm by explosion during single fault conditions	(See Clause B.4)	N/A
4.6	Fixing of conductors		P
	Fix conductors not to defeat a safeguard		P
	Compliance is checked by test..... :	(See Clause T.2)	P
4.7	Equipment for direct insertion into mains socket-outlets		N/A
4.7.2	Mains plug part complies with relevant standard .. :	Not direct plug-in plug	N/A
4.7.3	Torque (Nm)		N/A
4.8	Equipment containing coin/button cell batteries		N/A
4.8.1	General	No coin/button cell batteries used.	N/A
4.8.2	Instructional safeguard		N/A
4.8.3	Battery compartment door/cover construction		N/A
	Open torque test		N/A
4.8.4.2	Stress relief test		N/A
4.8.4.3	Battery replacement test		N/A
4.8.4.4	Drop test		N/A
4.8.4.5	Impact test		N/A
4.8.4.6	Crush test		N/A
4.8.5	Compliance		N/A
	30N force test with test probe		N/A
	20N force test with test hook		N/A
4.9	Likelihood of fire or shock due to entry of conductive object		N/A
4.10	Component requirements		P
4.10.1	Disconnect Device	(See Annex L)	P
4.10.2	Switches and relays	(See Annex G)	N/A
5	ELECTRICALLY-CAUSED INJURY		P
5.2	Classification and limits of electrical energy sources		P
5.2.2	ES1, ES2 and ES3 limits		P

IEC 62368-1			
Clause	Requirement + Test	Result - Remark	Verdict
5.2.2.2	Steady-state voltage and current limits	(See appended table 5.2)	P
5.2.2.3	Capacitance limits	(See appended table 5.2)	P
5.2.2.4	Single pulse limits	(See appended table 5.2)	N/A
5.2.2.5	Limits for repetitive pulses	(See appended table 5.2)	N/A
5.2.2.6	Ringings signals	(See Annex H)	N/A
5.2.2.7	Audio signals	(See Clause E.1)	N/A
5.3	Protection against electrical energy sources		P
5.3.1	General Requirements for accessible parts to ordinary, instructed and skilled persons	See table "OVERVIEW OF EMPLOYED SAFEGUARDS"	P
5.3.1 a)	Accessible ES1/ES2 derived from ES2/ES3 circuits		P
5.3.1 b)	Skilled persons not unintentional contact ES3 bare conductors		P
5.3.2.1	Accessibility to electrical energy sources and safeguards		P
	Accessibility to outdoor equipment bare parts		P
5.3.2.2	Contact requirements	No opening for enclosure.	P
	Test with test probe from Annex V		—
5.3.2.2 a)	Air gap – electric strength test potential (V)	(See appended table 5.4.9)	N/A
5.3.2.2 b)	Air gap – distance (mm)		N/A
5.3.2.3	Compliance		N/A
5.3.2.4	Terminals for connecting stripped wire	No stripped wire used.	N/A
5.4	Insulation materials and requirements		P
5.4.1.2	Properties of insulating material		P
5.4.1.3	Material is non-hygroscopic		P
5.4.1.4	Maximum operating temperature for insulating materials	(See appended table)	P
5.4.1.5	Pollution degrees	2	P
5.4.1.5.2	Test for pollution degree 1 environment and for an insulating compound	Pollution degree 2 is applied. No insulating compound applied	N/A
5.4.1.5.3	Thermal cycling test		N/A
5.4.1.6	Insulation in transformers with varying dimensions	No such transformer.	N/A
5.4.1.7	Insulation in circuits generating starting pulses	No such starting pulses.	N/A
5.4.1.8	Determination of working voltage	(See appended table 5.4.1.8)	P
5.4.1.9	Insulating surfaces		P
5.4.1.10	Thermoplastic parts on which conductive metallic parts are directly mounted		P

IEC 62368-1			
Clause	Requirement + Test	Result - Remark	Verdict
5.4.1.10.2	Vicat test.....:	(See appended table 5.4.1.10.2)	N/A
5.4.1.10.3	Ball pressure test	(See appended table 5.4.1.10.3)	P
5.4.2	Clearances	The highest value of 5.4.3.3 and 5.4.2.3 be used.	P
5.4.2.1	General requirements	Temporary overvoltage 2000Vpeak assumed	P
	Clearances in circuits connected to AC Mains, Alternative method	(See Annex X)	P
5.4.2.2	Procedure 1 for determining clearance		P
	Temporary overvoltage	2000	—
5.4.2.3	Procedure 2 for determining clearance		P
5.4.2.3.2.2	a.c. mains transient voltage	2500Vpeak	—
5.4.2.3.2.3	d.c. mains transient voltage	No dc mains	—
5.4.2.3.2.4	External circuit transient voltage.....:	No such transient	—
5.4.2.3.2.5	Transient voltage determined by measurement		—
5.4.2.4	Determining the adequacy of a clearance using an electric strength test	(See appended table 5.4.2)	N/A
5.4.2.5	Multiplication factors for clearances and test voltages		N/A
5.4.2.6	Clearance measurement	(See appended table 5.4.2)	P
5.4.3	Creepage distances		P
5.4.3.1	General		P
5.4.3.3	Material group		—
5.4.3.4	Creepage distances measurement	(See appended table 5.4.3)	P
5.4.4	Solid insulation		P
5.4.4.1	General requirements		P
5.4.4.2	Minimum distance through insulation	(See appended table 5.4.4.2)	P
5.4.4.3	Insulating compound forming solid insulation	Approved optocoupler used	P
5.4.4.4	Solid insulation in semiconductor devices	Approved optocoupler used	P
5.4.4.5	Insulating compound forming cemented joints		N/A
5.4.4.6	Thin sheet material	Polyester tape used in the transformers as functional/basic insulation	P
5.4.4.6.1	General requirements		P
5.4.4.6.2	Separable thin sheet material		P

IEC 62368-1			
Clause	Requirement + Test	Result - Remark	Verdict
	Number of layers (pcs)	2 layers	P
5.4.4.6.3	Non-separable thin sheet material	No such insulation used within the EUT	N/A
	Number of layers (pcs)		N/A
5.4.4.6.4	Standard test procedure for non-separable thin sheet material	(See appended table 5.4.9)	N/A
5.4.4.6.5	Mandrel test		N/A
5.4.4.7	Solid insulation in wound components		P
5.4.4.9	Solid insulation at frequencies >30 kHz, E_P , K_R , d , V_{PW} (V)	(See appended Table 5.4.4.9)	P
	Alternative by electric strength test, tested voltage (V), K_R	(See appended Tables 5.4.4.9 and 5.4.9)	N/A
5.4.5	Antenna terminal insulation		N/A
5.4.5.1	General		N/A
5.4.5.2	Voltage surge test		N/A
5.4.5.3	Insulation resistance (M Ω)		N/A
	Electric strength test	(See appended table 5.4.9)	N/A
5.4.6	Insulation of internal wire as part of supplementary safeguard		N/A
5.4.7	Tests for semiconductor components and for cemented joints		N/A
5.4.8	Humidity conditioning		P
	Relative humidity (%), temperature (°C), duration (h)	93%, 40°C, 120h	—
5.4.9	Electric strength test		P
5.4.9.1	Test procedure for type test of solid insulation	(See appended table 5.4.9)	P
5.4.9.2	Test procedure for routine test	Should be considered and conducted during production at factory.	N/A
5.4.10	Safeguards against transient voltages from external circuits	No such external circuits	N/A
5.4.10.1	Parts and circuits separated from external circuits		N/A
5.4.10.2	Test methods		N/A
5.4.10.2.1	General		N/A
5.4.10.2.2	Impulse test	(See appended table 5.4.9)	N/A
5.4.10.2.3	Steady-state test	(See appended table 5.4.9)	N/A
5.4.10.3	Verification for insulation breakdown for impulse test		N/A

IEC 62368-1			
Clause	Requirement + Test	Result - Remark	Verdict
5.4.11	Separation between external circuits and earth	No such external circuit.	N/A
5.4.11.1	Exceptions to separation between external circuits and earth		N/A
5.4.11.2	Requirements		N/A
	SPDs bridge separation between external circuit and earth		N/A
	Rated operating voltage U_{op} (V)..... :		—
	Nominal voltage U_{peak} (V)..... :		—
	Max increase due to variation ΔU_{sp} :		—
	Max increase due to ageing ΔU_{sa} :		—
5.4.11.3	Test method and compliance..... :	(See appended table 5.4.9)	N/A
5.4.12	Insulating liquid		N/A
5.4.12.1	General requirements		N/A
5.4.12.2	Electric strength of an insulating liquid..... :	(See appended table 5.4.9)	N/A
5.4.12.3	Compatibility of an insulating liquid..... :	(See appended table 5.4.9)	N/A
5.4.12.4	Container for insulating liquid..... :		N/A
5.5	Components as safeguards		P
5.5.1	General		P
5.5.2	Capacitors and RC units	Approved Y capacitor (CY1, CY2) provided.	P
5.5.2.1	General requirement		P
5.5.2.2	Safeguards against capacitor discharge after disconnection of a connector..... :	(See appended table 5.5.2.2)	P
5.5.3	Transformers		P
5.5.4	Optocouplers	(See sub-clause 5.4 or Clause G.12)	P
5.5.5	Relays	(See sub-clause 5.4)	N/A
5.5.6	Resistors	(See Clause G.10)	N/A
5.5.7	SPDs	(See Clause G.8)	P
5.5.8	Insulation between the mains and an external circuit consisting of a coaxial cable..... :	No such external circuits.	N/A
5.5.9	Safeguards for socket-outlets in outdoor equipment		N/A
	RCD rated residual operating current (mA)..... :		—
5.6	Protective conductor		P
5.6.2	Requirement for protective conductors		P
5.6.2.1	General requirements		P

IEC 62368-1			
Clause	Requirement + Test	Result - Remark	Verdict
5.6.2.2	Colour of insulation	Green/Yellow wire used	P
5.6.3	Requirement for protective earthing conductors	For models with supply cord and plug	P
	Protective earthing conductor size (mm ²) :	Rated current 1.5A, cross-sectional area min. 18AWG	—
	Protective earthing conductor serving as a reinforced safeguard		N/A
	Protective earthing conductor serving as a double safeguard		N/A
5.6.4	Requirements for protective bonding conductors		P
5.6.4.1	Protective bonding conductors		P
	Protective bonding conductor size (mm ²). :	0.5	—
5.6.4.2	Protective current rating (A)..... :	20A	P
5.6.5	Terminals for protective conductors	AC inlet direct connect to protective bonding wire	N/A
5.6.5.1	Terminal size for connecting protective earthing conductors (mm)..... :		N/A
	Terminal size for connecting protective bonding conductors (mm) :		N/A
5.6.5.2	Corrosion		N/A
5.6.6	Resistance of the protective bonding system		P
5.6.6.1	Requirements		P
5.6.6.2	Test Method..... :	(See appended table 5.6.6)	P
5.6.6.3	Resistance (Ω) or voltage drop..... :	(See appended table 5.6.6)	P
5.6.7	Reliable connection of a protective earthing conductor		N/A
5.6.8	Functional earthing		N/A
	Conductor size (mm ²)..... :		N/A
	Class II with functional earthing marking :		N/A
	Appliance inlet cl & cr (mm)..... :		N/A
5.7	Prospective touch voltage, touch current and protective conductor current		P
5.7.2	Measuring devices and networks		P
5.7.2.1	Measurement of touch current		P
5.7.2.2	Measurement of voltage		N/A
5.7.3	Equipment set-up, supply connections and earth connections		N/A
5.7.4	Unearthed accessible parts :	(See appended table 5.7.4)	P
5.7.5	Earthed accessible conductive parts :	(See appended table 5.7.5)	N/A

IEC 62368-1			
Clause	Requirement + Test	Result - Remark	Verdict
5.7.6	Requirements when touch current exceeds ES2 limits	No external circuits.	N/A
	Protective conductor current (mA)..... :		N/A
	Instructional Safeguard..... :		N/A
5.7.7	Prospective touch voltage and touch current associated with external circuits	No external circuits.	N/A
5.7.7.1	Touch current from coaxial cables		N/A
5.7.7.2	Prospective touch voltage and touch current associated with paired conductor cables		N/A
5.7.8	Summation of touch currents from external circuits		N/A
	a) Equipment connected to earthed external circuits, current (mA)		N/A
	b) Equipment connected to unearthed external circuits, current (mA)		N/A
5.8	Backfeed safeguard in battery backed up supplies		N/A
	Mains terminal ES..... :	(See appended table 5.8)	N/A
	Air gap (mm)..... :		N/A

IEC 62368-1			
Clause	Requirement + Test	Result - Remark	Verdict
6	ELECTRICALLY- CAUSED FIRE		P
6.2	Classification of PS and PIS		P
6.2.2	Power source circuit classifications	(See appended table 6.2.2)	P
6.2.3	Classification of potential ignition sources	See the following details.	P
6.2.3.1	Arcing PIS	(See appended table 6.2.3.1)	P
6.2.3.2	Resistive PIS	(See appended table 6.2.3.2)	P
6.3	Safeguards against fire under normal operating and abnormal operating conditions		P
6.3.1	No ignition and attainable temperature value less than 90 % defined by ISO 871 or less than 300 °C for unknown materials	No ignition and no such temperature attained within the equipment (See appended table B.1.5 and B.3)	P
	Combustible materials outside fire enclosure	Only output wire complying to 6.4.5.	N/A
6.4	Safeguards against fire under single fault conditions		P
6.4.1	Safeguard method	Method by control of fire spread applied, Fire enclosure provided.	P
6.4.2	Reduction of the likelihood of ignition under single fault conditions in PS1 circuits		N/A
6.4.3	Reduction of the likelihood of ignition under single fault conditions in PS2 and PS3 circuits		N/A
6.4.3.1	Supplementary safeguards		N/A
6.4.3.2	Single Fault Conditions	(See appended table B.4)	P
	Special conditions for temperature limited by fuse		N/A
6.4.4	Control of fire spread in PS1 circuits		N/A
6.4.5	Control of fire spread in PS2 circuits	Compliance detailed as follows: <ul style="list-style-type: none"> - <u>Printed board</u>: rated min. V-0 - <u>Wire insulation (tubing)</u>: complying with Clause 6 (See Table 4.1.2 for wiring used). - <u>All other components</u>: at least V-2 except for mounted on min. V-1 material or small parts of combustible material. <u>Isolating transformer</u> : complying with G.5.3.	P

IEC 62368-1			
Clause	Requirement + Test	Result - Remark	Verdict
6.4.5.2	Supplementary safeguards		P
6.4.6	Control of fire spread in PS3 circuits	Compliance detailed as follows: – <u>Parts as in 6.4.5 above including wiring</u> Fire enclosure rated V-0 used.	N/A
6.4.7	Separation of combustible materials from a PIS	Fire enclosure provided.	N/A
6.4.7.2	Separation by distance		N/A
6.4.7.3	Separation by a fire barrier		N/A
6.4.8	Fire enclosures and fire barriers	See below.	P
6.4.8.2	Fire enclosure and fire barrier material properties	The V-0 fire enclosure is used the overall enclosure.	P
6.4.8.2.1	Requirements for a fire barrier	No fire barrier used.	N/A
6.4.8.2.2	Requirements for a fire enclosure	The V-0 fire enclosure is used the overall enclosure as above.	P
6.4.8.3	Constructional requirements for a fire enclosure and a fire barrier		P
6.4.8.3.1	Fire enclosure and fire barrier openings		P
6.4.8.3.2	Fire barrier dimensions		N/A
6.4.8.3.3	Top openings and properties	No openings.	N/A
	Openings dimensions (mm)..... :		N/A
6.4.8.3.4	Bottom openings and properties		N/A
	Openings dimensions (mm)..... :		N/A
	Flammability tests for the bottom of a fire enclosure	(See Clause S.3)	N/A
	Instructional Safeguard..... :		N/A
6.4.8.3.5	Side openings and properties		N/A
	Openings dimensions (mm)..... :		N/A
6.4.8.3.6	Integrity of a fire enclosure, condition met: a), b) or c)..... :		N/A
6.4.8.4	Separation of a PIS from a fire enclosure and a fire barrier distance (mm) or flammability rating :	Fire enclosure is made of V-0 material.	N/A
6.4.9	Flammability of insulating liquid..... :		N/A
6.5	Internal and external wiring		P
6.5.1	General requirements	Evaluated per IEC/EN 60950-1 based on Cl. 4.1.1	P
6.5.2	Requirements for interconnection to building wiring :		N/A

IEC 62368-1			
Clause	Requirement + Test	Result - Remark	Verdict
6.5.3	Internal wiring size (mm ²) for socket-outlets..... :		N/A
6.6	Safeguards against fire due to the connection to additional equipment		P

7	INJURY CAUSED BY HAZARDOUS SUBSTANCES		P
7.2	Reduction of exposure to hazardous substances		P
7.3	Ozone exposure		N/A
7.4	Use of personal safeguards or personal protective equipment (PPE)		N/A
	Personal safeguards and instructions		—
7.5	Use of instructional safeguards and instructions		N/A
	Instructional safeguard (ISO 7010)..... :		—
7.6	Batteries and their protection circuits		N/A

8	MECHANICALLY-CAUSED INJURY		P
8.2	Mechanical energy source classifications		P
8.3	Safeguards against mechanical energy sources		N/A
8.4	Safeguards against parts with sharp edges and corners		P
8.4.1	Safeguards		N/A
	Instructional Safeguard		N/A
8.4.2	Sharp edges or corners		N/A
8.5	Safeguards against moving parts		N/A
8.5.1	Fingers, jewellery, clothing, hair, etc., contact with MS2 or MS3 parts		N/A
	MS2 or MS3 part required to be accessible for the function of the equipment		N/A
	Moving MS3 parts only accessible to skilled person		N/A
8.5.2	Instructional safeguard..... :		N/A
8.5.4	Special categories of equipment containing moving parts		N/A
8.5.4.1	General		N/A
8.5.4.2	Equipment containing work cells with MS3 parts		N/A
8.5.4.2.1	Protection of persons in the work cell		N/A
8.5.4.2.2	Access protection override		N/A
8.5.4.2.2.1	Override system		N/A
8.5.4.2.2.2	Visual indicator		N/A
8.5.4.2.3	Emergency stop system		N/A

IEC 62368-1			
Clause	Requirement + Test	Result - Remark	Verdict
	Maximum stopping distance from the point of activation (m).....:		N/A
	Space between end point and nearest fixed mechanical part (mm)		N/A
8.5.4.2.4	Endurance requirements		N/A
	Mechanical system subjected to 100 000 cycles of operation		N/A
	- Mechanical function check and visual inspection		N/A
	- Cable assembly		N/A
8.5.4.3	Equipment having electromechanical device for destruction of media		N/A
8.5.4.3.1	Equipment safeguards		N/A
8.5.4.3.2	Instructional safeguards against moving parts		N/A
8.5.4.3.3	Disconnection from the supply		N/A
8.5.4.3.4	Cut type and test force (N).....:		N/A
8.5.4.3.5	Compliance		N/A
8.5.5	High pressure lamps		N/A
	Explosion test		N/A
8.5.5.3	Glass particles dimensions (mm)		N/A
8.6	Stability of equipment		N/A
8.6.1	General		N/A
	Instructional safeguard.....:		N/A
8.6.2	Static stability		N/A
8.6.2.2	Static stability test		N/A
8.6.2.3	Downward force test		N/A
8.6.3	Relocation stability		N/A
	Wheels diameter (mm)		—
	Tilt test		N/A
8.6.4	Glass slide test		N/A
8.6.5	Horizontal force test		N/A
8.7	Equipment mounted to wall, ceiling or other structure		N/A
8.7.1	Mount means type		N/A
8.7.2	Test methods		N/A
	Test 1, additional downwards force (N).....:		N/A

IEC 62368-1			
Clause	Requirement + Test	Result - Remark	Verdict
	Test 2, number of attachment points and test force (N).....:		N/A
	Test 3 Nominal diameter (mm) and applied torque (Nm).....:		N/A
8.8	Handles strength		N/A
8.8.1	General		N/A
8.8.2	Handle strength test		N/A
	Number of handles.....:		—
	Force applied (N)		—
8.9	Wheels or casters attachment requirements		N/A
8.9.2	Pull test		N/A
8.10	Carts, stands and similar carriers		N/A
8.10.1	General		N/A
8.10.2	Marking and instructions.....:		N/A
8.10.3	Cart, stand or carrier loading test		N/A
	Loading force applied (N)		N/A
8.10.4	Cart, stand or carrier impact test		N/A
8.10.5	Mechanical stability		N/A
	Force applied (N)		—
8.10.6	Thermoplastic temperature stability		N/A
8.11	Mounting means for slide-rail mounted equipment (SRME)		N/A
8.11.1	General		N/A
8.11.2	Requirements for slide rails		N/A
	Instructional Safeguard.....:		N/A
8.11.3	Mechanical strength test		N/A
8.11.3.1	Downward force test, force (N) applied.....:		N/A
8.11.3.2	Lateral push force test		N/A
8.11.3.3	Integrity of slide rail end stops		N/A
8.11.4	Compliance		N/A
8.12	Telescoping or rod antennas		N/A
	Button/ball diameter (mm)		—
9	THERMAL BURN INJURY		P
9.2	Thermal energy source classifications		P
9.3	Touch temperature limits		N/A

IEC 62368-1			
Clause	Requirement + Test	Result - Remark	Verdict
9.3.1	Touch temperatures of accessible parts	(See appended table)	N/A
9.3.2	Test method and compliance		N/A
9.4	Safeguards against thermal energy sources		N/A
9.5	Requirements for safeguards		N/A
9.5.1	Equipment safeguard		N/A
9.5.2	Instructional safeguard.....		N/A
9.6	Requirements for wireless power transmitters		N/A
9.6.1	General		N/A
9.6.2	Specification of the foreign objects		N/A
9.6.3	Test method and compliance	(See appended table 9.6)	N/A

10	RADIATION		N/A
10.2	Radiation energy source classification		N/A
10.2.1	General classification		N/A
	Lasers		—
	Lamps and lamp systems		—
	Image projectors		—
	X-Ray		—
	Personal music player		—
10.3	Safeguards against laser radiation		N/A
	The standard(s) equipment containing laser(s) comply		N/A
10.4	Safeguards against optical radiation from lamps and lamp systems (including LED types)		N/A
10.4.1	General requirements		N/A
	Instructional safeguard provided for accessible radiation level needs to exceed		N/A
	Risk group marking and location		N/A
	Information for safe operation and installation		N/A
10.4.2	Requirements for enclosures		N/A
	UV radiation exposure	(See Annex C)	N/A
10.4.3	Instructional safeguard		N/A
10.5	Safeguards against X-radiation		N/A
10.5.1	Requirements		N/A
	Instructional safeguard for skilled persons		—

IEC 62368-1			
Clause	Requirement + Test	Result - Remark	Verdict
10.5.3	Maximum radiation (pA/kg)..... :	(See appended tables B.3 & B.4)	—
10.6	Safeguards against acoustic energy sources		N/A
10.6.1	General		N/A
10.6.2	Classification		N/A
	Acoustic output $L_{Aeq,T}$, dB(A)..... :		N/A
	Unweighted RMS output voltage (mV)..... :		N/A
	Digital output signal (dBFS)..... :		N/A
10.6.3	Requirements for dose-based systems		N/A
10.6.3.1	General requirements		N/A
10.6.3.2	Dose-based warning and automatic decrease		N/A
10.6.3.3	Exposure-based warning and requirements		N/A
	30 s integrated exposure level (MEL30)..... :		N/A
	Warning for MEL \geq 100 dB(A)..... :		N/A
10.6.4	Measurement methods		N/A
10.6.5	Protection of persons		N/A
	Instructional safeguards..... :		N/A
10.6.6	Requirements for listening devices (headphones, earphones, etc.)		N/A
10.6.6.1	Corded listening devices with analogue input		N/A
	Listening device input voltage (mV)..... :		N/A
10.6.6.2	Corded listening devices with digital input		N/A
	Max. acoustic output $L_{Aeq,T}$, dB(A)..... :		N/A
10.6.6.3	Cordless listening devices		N/A
	Max. acoustic output $L_{Aeq,T}$, dB(A)..... :		N/A

B	NORMAL OPERATING CONDITION TESTS, ABNORMAL OPERATING CONDITION TESTS AND SINGLE FAULT CONDITION TESTS		P
B.1	General		P
B.1.5	Temperature measurement conditions	(See appended table B.1.5)	P
B.2	Normal operating conditions		P
B.2.1	General requirements..... :	(See Test Item Particulars and appended test tables)	P
	Audio Amplifiers and equipment with audio amplifiers..... :	(See Annex E)	N/A
B.2.3	Supply voltage and tolerances	+10 % and -10 % considered	P

IEC 62368-1			
Clause	Requirement + Test	Result - Remark	Verdict
B.2.5	Input test	(See appended table B.2.5)	P
B.3	Simulated abnormal operating conditions		P
B.3.1	General		P
B.3.2	Covering of ventilation openings		N/A
	Instructional safeguard		N/A
B.3.3	DC mains polarity test	The EUT is not connected to a D.C. mains	N/A
B.3.4	Setting of voltage selector	No voltage selector was used	N/A
B.3.5	Maximum load at output terminals		P
B.3.6	Reverse battery polarity	No battery within the EUT	N/A
B.3.7	Audio amplifier abnormal operating conditions	Not such equipment.	N/A
B.3.8	Safeguards functional during and after abnormal operating conditions	(See appended table B.3)	P
B.4	Simulated single fault conditions		P
B.4.1	General		P
B.4.2	Temperature controlling device		N/A
B.4.3	Blocked motor test		N/A
B.4.4	Functional insulation		P
B.4.4.1	Short circuit of clearances for functional insulation		P
B.4.4.2	Short circuit of creepage distances for functional insulation		P
B.4.4.3	Short circuit of functional insulation on coated printed boards		N/A
B.4.5	Short-circuit and interruption of electrodes in tubes and semiconductors		P
B.4.6	Short circuit or disconnection of passive components		P
B.4.7	Continuous operation of components	The EUT is continuous operating type and no such components intended for short time operation or intermittent operation	N/A
B.4.8	Compliance during and after single fault conditions	(See appended table B.4)	P
B.4.9	Battery charging and discharging under single fault conditions	(See Annex M)	N/A
C	UV RADIATION		N/A
C.1	Protection of materials in equipment from UV radiation		N/A

IEC 62368-1			
Clause	Requirement + Test	Result - Remark	Verdict
C.1.2	Requirements	No UV generated from the equipment	N/A
C.1.3	Test method		N/A
C.2	UV light conditioning test		N/A
C.2.1	Test apparatus..... :		N/A
C.2.2	Mounting of test samples		N/A
C.2.3	Carbon-arc light-exposure test		N/A
C.2.4	Xenon-arc light-exposure test		N/A
D	TEST GENERATORS		N/A
D.1	Impulse test generators		N/A
D.2	Antenna interface test generator		N/A
D.3	Electronic pulse generator		N/A
E	TEST CONDITIONS FOR EQUIPMENT CONTAINING AUDIO AMPLIFIERS		N/A
E.1	Electrical energy source classification for audio signals		N/A
	Maximum non-clipped output power (W)..... :		—
	Rated load impedance (Ω)		—
	Open-circuit output voltage (V)..... :		—
	Instructional safeguard	See Clause F.5	—
E.2	Audio amplifier normal operating conditions		N/A
	Audio signal source type		—
	Audio output power (W)..... :		—
	Audio output voltage (V)		—
	Rated load impedance (Ω)		—
	Requirements for temperature measurement	(See Table B.1.5)	N/A
E.3	Audio amplifier abnormal operating conditions	(See Table B.3, B.4)	N/A
F	EQUIPMENT MARKINGS, INSTRUCTIONS, AND INSTRUCTIONAL SAFEGUARDS		P
F.1	General		P
	Language	English	—
F.2	Letter symbols and graphical symbols		P
F.2.1	Letter symbols according to IEC60027-1	Letter symbols for quantities and units are complied with IEC 60027-1.	N/A
F.2.2	Graphic symbols according to IEC, ISO or manufacturer specific	Graphical symbols are complied with IEC 60417, ISO 3864-2, ISO 7000 or ISO 7010.	P

IEC 62368-1			
Clause	Requirement + Test	Result - Remark	Verdict
F.3	Equipment markings		P
F.3.1	Equipment marking locations	The required marking is located on the enclosure of the equipment and is easily visible.	P
F.3.2	Equipment identification markings	See copy of marking plate.	P
F.3.2.1	Manufacturer identification	See copy of marking plate.	P
F.3.2.2	Model identification	See model list.	P
F.3.3	Equipment rating markings	See the following details.	P
F.3.3.1	Equipment with direct connection to mains	The equipment is direct connected to AC mains, see F.3.3.3 to F.3.3.6.	P
F.3.3.2	Equipment without direct connection to mains		N/A
F.3.3.3	Nature of the supply voltage	AC	P
F.3.3.4	Rated voltage	See copy of marking plate.	P
F.3.3.5	Rated frequency	See copy of marking plate.	P
F.3.3.6	Rated current or rated power	See copy of marking plate.	P
F.3.3.7	Equipment with multiple supply connections	Only one mains supply connection provided.	N/A
F.3.4	Voltage setting device	No voltage setting device.	N/A
F.3.5	Terminals and operating devices	See below	P
F.3.5.1	Mains appliance outlet and socket-outlet markings	No outlet used.	N/A
F.3.5.2	Switch position identification marking	No switch used.	N/A
F.3.5.3	Replacement fuse identification and rating markings	The fuse is located within the equipment and not replaceable by an ordinary person or an instructed person. The fuse is marked with F1, F2 or FS1, FS2: T3.15A 250V	P
	Instructional safeguards for neutral fuse		N/A
F.3.5.4	Replacement battery identification marking	No such battery on the equipment. See sub-clause F.5	N/A
F.3.5.5	Neutral conductor terminal		N/A
F.3.5.6	Terminal marking location		N/A
F.3.6	Equipment markings related to equipment classification	See below	P
F.3.6.1	Class I equipment		N/A
F.3.6.1.1	Protective earthing conductor terminal		N/A
F.3.6.1.2	Protective bonding conductor terminals		N/A

IEC 62368-1			
Clause	Requirement + Test	Result - Remark	Verdict
F.3.6.2	Equipment class marking	See copy of marking plate.	P
F.3.6.3	Functional earthing terminal marking	See copy of marking plate.	P
F.3.7	Equipment IP rating marking	See copy of marking plate.	N/A
F.3.8	External power supply output marking	See copy of marking plate.	P
F.3.9	Durability, legibility and permanence of marking	Marking is considered to be legible and easily discernible. See also the following details.	P
F.3.10	Test for permanence of markings	The label was subjected to the permanence of marking test. The label was rubbed with cloth soaked with water for 15 sec. And then again for 15 sec. With the cloth soaked with petroleum spirit. After this test there was no damage to the label. The marking on the label did not fade. There was no curling and lifting of the label edge. After each test, the marking remained legible.	P
F.4	Instructions		P
	a) Information prior to installation and initial use		P
	b) Equipment for use in locations where children not likely to be present		P
	c) Instructions for installation and interconnection		N/A
	d) Equipment intended for use only in restricted access area		N/A
	e) Equipment intended to be fastened in place	No such terminals provided.	N/A
	f) Instructions for audio equipment terminals		N/A
	g) Protective earthing used as a safeguard		N/A
	h) Protective conductor current exceeding ES2 limits		N/A
	i) Graphic symbols used on equipment		N/A
	j) Permanently connected equipment not provided with all-pole mains switch	Not permanently connected equipment.	N/A
	k) Replaceable components or modules providing safeguard function	No such markings.	N/A
	l) Equipment containing insulating liquid		N/A
	m) Installation instructions for outdoor equipment		N/A
F.5	Instructional safeguards		N/A

IEC 62368-1			
Clause	Requirement + Test	Result - Remark	Verdict
G	COMPONENTS		P
G.1	Switches		N/A
G.1.1	General	No switch used.	N/A
G.1.2	Ratings, endurance, spacing, maximum load		N/A
G.1.3	Test method and compliance		N/A
G.2	Relays		N/A
G.2.1	Requirements	No relay used.	N/A
G.2.2	Overload test		N/A
G.2.3	Relay controlling connectors supplying power to other equipment		N/A
G.2.4	Test method and compliance		N/A
G.3	Protective devices		P
G.3.1	Thermal cut-offs	No thermal cut-off used.	N/A
	Thermal cut-outs separately approved according to IEC 60730 with conditions indicated in a) & b)		N/A
	Thermal cut-outs tested as part of the equipment as indicated in c)		N/A
G.3.1.2	Test method and compliance		N/A
G.3.2	Thermal links		N/A
G.3.2.1	a) Thermal links tested separately according to IEC 60691 with specifics		N/A
	b) Thermal links tested as part of the equipment		N/A
G.3.2.2	Test method and compliance		N/A
G.3.3	PTC thermistors	No PTC thermistor used.	N/A
G.3.4	Overcurrent protection devices	Certified fuse used according to IEC 60127.	P
G.3.5	Safeguards components not mentioned in G.3.1 to G.3.4		N/A
G.3.5.1	Non-resettable devices suitably rated and marking provided		N/A
G.3.5.2	Single faults conditions..... :	(See appended table B.4)	N/A
G.4	Connectors		N/A
G.4.1	Spacings		N/A
G.4.2	Mains connector configuration		N/A
G.4.3	Plug is shaped that insertion into mains socket-outlets or appliance coupler is unlikely		N/A
G.5	Wound components		P

IEC 62368-1			
Clause	Requirement + Test	Result - Remark	Verdict
G.5.1	Wire insulation in wound components	Approved Insulated wire used as Reinforced insulation for secondary winding of T1.	P
G.5.1.2	Protection against mechanical stress		P
G.5.2	Endurance test		P
G.5.2.1	General test requirements		N/A
G.5.2.2	Heat run test		N/A
	Test time (days per cycle)		—
	Test temperature (°C).....		—
G.5.2.3	Wound components supplied from the mains		N/A
G.5.2.4	No insulation breakdown		N/A
G.5.3	Transformers		P
G.5.3.1	Compliance method.....	The transformer meets the requirements given in G.5.3.2 and G.5.3.3.	P
	Position	T1	P
	Method of protection.....	See G.5.3.3	P
G.5.3.2	Insulation	Primary windings and secondary windings are separated by Reinforced insulation (The core is considered as primary part as it is not isolated from Primary)	P
	Protection from displacement of windings.....	The end-turn of each winding is fixed by insulating tape	—
G.5.3.3	Transformer overload tests	(See appended table B.3 & B.4)	P
G.5.3.3.1	Test conditions	Tested in the complete equipment as an SMPS.	P
G.5.3.3.2	Winding temperatures	(See appended table B.3&B.4)	P
G.5.3.3.3	Winding temperatures - alternative test method	Alternative test method was not considered.	N/A
G.5.3.4	Transformers using FIW		N/A
G.5.3.4.1	General		N/A
	FIW wire nominal diameter		—
G.5.3.4.2	Transformers with basic insulation only		N/A
G.5.3.4.3	Transformers with double insulation or reinforced insulation.....		N/A
G.5.3.4.4	Transformers with FIW wound on metal or ferrite core		N/A

IEC 62368-1			
Clause	Requirement + Test	Result - Remark	Verdict
G.5.3.4.5	Thermal cycling test and compliance		N/A
G.5.3.4.6	Partial discharge test		N/A
G.5.3.4.7	Routine test		N/A
G.5.4	Motors		N/A
G.5.4.1	General requirements		N/A
G.5.4.2	Motor overload test conditions		N/A
G.5.4.3	Running overload test		N/A
G.5.4.4.2	Locked-rotor overload test		N/A
	Test duration (days)		—
G.5.4.5	Running overload test for DC motors		N/A
G.5.4.5.2	Tested in the unit		N/A
G.5.4.5.3	Alternative method		N/A
G.5.4.6	Locked-rotor overload test for DC motors		N/A
G.5.4.6.2	Tested in the unit		N/A
	Maximum Temperature		N/A
G.5.4.6.3	Alternative method		N/A
G.5.4.7	Motors with capacitors		N/A
G.5.4.8	Three-phase motors		N/A
G.5.4.9	Series motors		N/A
	Operating voltage		—
G.6	Wire Insulation		P
G.6.1	General	Triple insulated winding in T1 secondary windings used as reinforced safeguard in the isolating transformer that has separately complied with Annex J. See Appended table 4.1.2. No other wires used in the EUT.	P
G.6.2	Enamelled winding wire insulation	Insulation does not rely on solvent-based enamel.	P
G.7	Mains supply cords		N/A
G.7.1	General requirements		N/A
	Type		—
G.7.2	Cross sectional area (mm ² or AWG)		N/A
G.7.3	Cord anchorages and strain relief for non-detachable power supply cords		N/A
G.7.3.2	Cord strain relief		N/A

IEC 62368-1			
Clause	Requirement + Test	Result - Remark	Verdict
G.7.3.2.1	Requirements		N/A
	Strain relief test force (N)..... :		N/A
G.7.3.2.2	Strain relief mechanism failure		N/A
G.7.3.2.3	Cord sheath or jacket position, distance (mm) :		N/A
G.7.3.2.4	Strain relief and cord anchorage material		N/A
G.7.4	Cord Entry		N/A
G.7.5	Non-detachable cord bend protection		N/A
G.7.5.1	Requirements		N/A
G.7.5.2	Test method and compliance		N/A
	Overall diameter or minor overall dimension, D (mm) :		—
	Radius of curvature after test (mm)..... :		—
G.7.6	Supply wiring space		N/A
G.7.6.1	General requirements		N/A
G.7.6.2	Stranded wire	No such wire.	N/A
G.7.6.2.1	Requirements		N/A
G.7.6.2.2	Test with 8 mm strand		N/A
G.8	Varistors		P
G.8.1	General requirements	Approved VDR used	P
G.8.2	Safeguards against fire	Fire enclosure used in the product	P
G.8.2.1	General		P
G.8.2.2	Varistor overload test		P
G.8.2.3	Temporary overvoltage test		N/A
G.9	Integrated circuit (IC) current limiters		N/A
G.9.1	Requirements	No IC current limiter provided within the equipment.	N/A
	IC limiter output current (max. 5A) :		—
	Manufacturers' defined drift :		—
G.9.2	Test Program		N/A
G.9.3	Compliance		N/A
G.10	Resistors		P
G.10.1	General		P
G.10.2	Conditioning		P
G.10.3	Resistor test		N/A

IEC 62368-1			
Clause	Requirement + Test	Result - Remark	Verdict
G.10.4	Voltage surge test		N/A
G.10.5	Impulse test		N/A
G.10.6	Overload test		P
G.11	Capacitors and RC units		P
G.11.1	General requirements	Y1-capacitor or Y2-capacitor used as Reinforced safeguard which complies with IEC/EN 60384-14.	P
G.11.2	Conditioning of capacitors and RC units	Y1 capacitor or Y2 capacitor complied as environmental category at least 25/100/21 (21 days humidity) or 30/125/56 (56 days humidity) and in any case at 40°C	P
G.11.3	Rules for selecting capacitors	The selection followed with tables G.9 and G.12. Y1 capacitor or Y2-capacitor bridging Reinforced insulation with rated voltage at least 250V tested with impulse 8kV peak and 4kV rms	P
G.12	Optocouplers		P
	Optocouplers comply with IEC 60747-5-5 with specifics		P
	Type test voltage $V_{ini,a}$	(see appended table 4.1.2)	—
	Routine test voltage, $V_{ini,b}$	(see appended table 4.1.2)	—
G.13	Printed boards		P
G.13.1	General requirements	See the following details.	P
G.13.2	Uncoated printed boards	The insulation between conductors on the outer surfaces of an uncoated printed board complied with the minimum clearance and creepage requirements	P
G.13.3	Coated printed boards	No coated printed board or multilayer board applied for within the equipment.	N/A
G.13.4	Insulation between conductors on the same inner surface		N/A
G.13.5	Insulation between conductors on different surfaces		P
	Distance through insulation	Min. 0.4mm	P
	Number of insulation layers (pcs)		—
G.13.6	Tests on coated printed boards		N/A

IEC 62368-1			
Clause	Requirement + Test	Result - Remark	Verdict
G.13.6.1	Sample preparation and preliminary inspection		N/A
G.13.6.2	Test method and compliance		N/A
G.14	Coating on components terminals		N/A
G.14.1	Requirements	(See Clause G.13)	N/A
G.15	Pressurized liquid filled components		N/A
G.15.1	Requirements		N/A
G.15.2	Test methods and compliance		N/A
G.15.2.1	Hydrostatic pressure test		N/A
G.15.2.2	Creep resistance test		N/A
G.15.2.3	Tubing and fittings compatibility test		N/A
G.15.2.4	Vibration test		N/A
G.15.2.5	Thermal cycling test		N/A
G.15.2.6	Force test		N/A
G.15.3	Compliance		N/A
G.16	IC including capacitor discharge function (ICX)		N/A
G.16.1	Condition for fault tested is not required		N/A
	ICX with associated circuitry tested in equipment		N/A
	ICX tested separately		N/A
G.16.2	Tests		N/A
	Smallest capacitance and smallest resistance specified by ICX manufacturer for impulse test..... :		—
	Mains voltage that impulses to be superimposed on		—
	Largest capacitance and smallest resistance for ICX tested by itself for 10000 cycles test		—
G.16.3	Capacitor discharge test..... :		N/A
H	CRITERIA FOR TELEPHONE RINGING SIGNALS		N/A
H.1	General		N/A
H.2	Method A		N/A
H.3	Method B		N/A
H.3.1	Ringling signal		N/A
H.3.1.1	Frequency (Hz)		—
H.3.1.2	Voltage (V)		—
H.3.1.3	Cadence; time (s) and voltage (V)		—
H.3.1.4	Single fault current (mA):..... :		—

IEC 62368-1			
Clause	Requirement + Test	Result - Remark	Verdict
H.3.2	Tripping device and monitoring voltage		N/A
H.3.2.1	Conditions for use of a tripping device or a monitoring voltage		N/A
H.3.2.2	Tripping device		N/A
H.3.2.3	Monitoring voltage (V)		N/A
J	INSULATED WINDING WIRES FOR USE WITHOUT INTERLEAVED INSULATION		P
J.1	General		P
	Winding wire insulation	Certified TIW used. Reinforced insulation	—
	Solid round winding wire, diameter (mm)	Φ0.55mm	P
	Solid square and rectangular (flatwise bending) winding wire, cross-sectional area (mm ²)		N/A
J.2/J.3	Tests and Manufacturing	(See separate test report)	—
K	SAFETY INTERLOCKS		N/A
K.1	General requirements		N/A
	Instructional safeguard		N/A
K.2	Components of safety interlock safeguard mechanism		N/A
K.3	Inadvertent change of operating mode		N/A
K.4	Interlock safeguard override		N/A
K.5	Fail-safe		N/A
K.5.1	Under single fault condition		N/A
K.6	Mechanically operated safety interlocks		N/A
K.6.1	Endurance requirement		N/A
K.6.2	Test method and compliance		N/A
K.7	Interlock circuit isolation		N/A
K.7.1	Separation distance for contact gaps & interlock circuit elements		N/A
	In circuit connected to mains, separation distance for contact gaps (mm)		N/A
	In circuit isolated from mains, separation distance for contact gaps (mm)		N/A
	Electric strength test before and after the test of K.7.2	(See appended table 5.4.9)	N/A
K.7.2	Overload test, Current (A)		N/A
K.7.3	Endurance test		N/A
K.7.4	Electric strength test		N/A

IEC 62368-1			
Clause	Requirement + Test	Result - Remark	Verdict
L	DISCONNECT DEVICES		P
L.1	General requirements	With integral plug as the disconnection device.	P
L.2	Permanently connected equipment		N/A
L.3	Parts that remain energized		N/A
L.4	Single-phase equipment		P
L.5	Three-phase equipment		N/A
L.6	Switches as disconnect devices		N/A
L.7	Plugs as disconnect devices		P
L.8	Multiple power sources		N/A
	Instructional safeguard		N/A
M	EQUIPMENT CONTAINING BATTERIES AND THEIR PROTECTION CIRCUITS		N/A
M.1	General requirements		N/A
M.2	Safety of batteries and their cells		N/A
M.2.1	Batteries and their cells comply with relevant IEC standards		N/A
M.3	Protection circuits for batteries provided within the equipment		N/A
M.3.1	Requirements		N/A
M.3.2	Test method		N/A
	Overcharging of a rechargeable battery		N/A
	Excessive discharging		N/A
	Unintentional charging of a non-rechargeable battery		N/A
	Reverse charging of a rechargeable battery		N/A
M.3.3	Compliance	(See appended table M.3)	N/A
M.4	Additional safeguards for equipment containing a portable secondary lithium battery		N/A
M.4.1	General		N/A
M.4.2	Charging safeguards		N/A
M.4.2.1	Requirements		N/A
M.4.2.2	Compliance	(See appended table M.4.2)	N/A
M.4.3	Fire enclosure		N/A
M.4.4	Drop test of equipment containing a secondary lithium battery		N/A
M.4.4.2	Preparation and procedure for the drop test		N/A

IEC 62368-1			
Clause	Requirement + Test	Result - Remark	Verdict
M.4.4.3	Drop, Voltage on reference and dropped batteries (V); voltage difference during 24 h period (%): :		N/A
M.4.4.4	Check of the charge/discharge function		N/A
M.4.4.5	Charge / discharge cycle test		N/A
M.4.4.6	Compliance		N/A
M.5	Risk of burn due to short-circuit during carrying		N/A
M.5.1	Requirement		N/A
M.5.2	Test method and compliance		N/A
M.6	Safeguards against short-circuits		N/A
M.6.1	External and internal faults		N/A
M.6.2	Compliance		N/A
M.7	Risk of explosion from lead acid and NiCd batteries		N/A
M.7.1	Ventilation preventing explosive gas concentration		N/A
	Calculated hydrogen generation rate :		N/A
M.7.2	Test method and compliance		N/A
	Minimum air flow rate, Q (m ³ /h)..... :		N/A
M.7.3	Ventilation tests		N/A
M.7.3.1	General		N/A
M.7.3.2	Ventilation test – alternative 1		N/A
	Hydrogen gas concentration (%) :		N/A
M.7.3.3	Ventilation test – alternative 2		N/A
	Obtained hydrogen generation rate..... :		N/A
M.7.3.4	Ventilation test – alternative 3		N/A
	Hydrogen gas concentration (%) :		N/A
M.7.4	Marking :		N/A
M.8	Protection against internal ignition from external spark sources of batteries with aqueous electrolyte		N/A
M.8.1	General		N/A
M.8.2	Test method		N/A
M.8.2.1	General		N/A
M.8.2.2	Estimation of hypothetical volume V_z (m ³ /s) :		—
M.8.2.3	Correction factors :		—
M.8.2.4	Calculation of distance d (mm) :		—
M.9	Preventing electrolyte spillage		N/A
M.9.1	Protection from electrolyte spillage		N/A

IEC 62368-1			
Clause	Requirement + Test	Result - Remark	Verdict
M.9.2	Tray for preventing electrolyte spillage		N/A
M.10	Instructions to prevent reasonably foreseeable misuse		N/A
	Instructional safeguard		N/A
N	ELECTROCHEMICAL POTENTIALS		N/A
	Material(s) used		—
O	MEASUREMENT OF CREEPAGE DISTANCES AND CLEARANCES		P
	Value of X (mm)	Considered.	—
P	SAFEGUARDS AGAINST CONDUCTIVE OBJECTS		N/A
P.1	General		N/A
P.2	Safeguards against entry or consequences of entry of a foreign object		N/A
P.2.1	General		N/A
P.2.2	Safeguards against entry of a foreign object	No opening	N/A
	Location and Dimensions (mm)		—
P.2.3	Safeguards against the consequences of entry of a foreign object		N/A
P.2.3.1	Safeguard requirements		N/A
	The ES3 and PS3 keep-out volume in Figure P.3 not applicable to transportable equipment		N/A
	Transportable equipment with metalized plastic parts		N/A
P.2.3.2	Consequence of entry test		N/A
P.3	Safeguards against spillage of internal liquids		N/A
P.3.1	General		N/A
P.3.2	Determination of spillage consequences		N/A
P.3.3	Spillage safeguards		N/A
P.3.4	Compliance		N/A
P.4	Metallized coatings and adhesives securing parts		N/A
P.4.1	General		N/A
P.4.2	Tests		N/A
	Conditioning, T _c (°C)		—
	Duration (weeks)		—
Q	CIRCUITS INTENDED FOR INTERCONNECTION WITH BUILDING WIRING		P
Q.1	Limited power sources	See appended table Annex Q.1	P
Q.1.1	Requirements		P
	a) Inherently limited output		N/A

IEC 62368-1			
Clause	Requirement + Test	Result - Remark	Verdict
	b) Impedance limited output		P
	c) Regulating network limited output	A regulating network limits the output in compliance with table Q.1 both under normal operating conditions and after any single fault.	P
	d) Overcurrent protective device limited output		N/A
	e) IC current limiter complying with G.9		N/A
Q.1.2	Test method and compliance	(See appended table Q.1)	P
	Current rating of overcurrent protective device (A)		N/A
Q.2	Test for external circuits – paired conductor cable	No such consideration.	N/A
	Maximum output current (A)		N/A
	Current limiting method		—
R	LIMITED SHORT CIRCUIT TEST		N/A
R.1	General	No such consideration.	N/A
R.2	Test setup		N/A
	Overcurrent protective device for test		—
R.3	Test method		N/A
	Cord/cable used for test		—
R.4	Compliance		N/A
S	TESTS FOR RESISTANCE TO HEAT AND FIRE		P
S.1	Flammability test for fire enclosures and fire barrier materials of equipment where the steady state power does not exceed 4 000 W		P
	Samples, material	Approved fire enclosure with V-0 material used.	—
	Wall thickness (mm)		—
	Conditioning (°C)		—
	Test flame according to IEC 60695-11-5 with conditions as set out		N/A
	- Material not consumed completely		N/A
	- Material extinguishes within 30s		N/A
	- No burning of layer or wrapping tissue		N/A
S.2	Flammability test for fire enclosure and fire barrier integrity		N/A
	Samples, material		—
	Wall thickness (mm)		—

IEC 62368-1			
Clause	Requirement + Test	Result - Remark	Verdict
	Conditioning (°C)		—
S.3	Flammability test for the bottom of a fire enclosure		N/A
S.3.1	Mounting of samples		N/A
S.3.2	Test method and compliance		N/A
	Mounting of samples		—
	Wall thickness (mm)		—
S.4	Flammability classification of materials		N/A
S.5	Flammability test for fire enclosure materials of equipment with a steady state power exceeding 4 000 W		N/A
	Samples, material		—
	Wall thickness (mm)		—
	Conditioning (°C)		—
T	MECHANICAL STRENGTH TESTS		P
T.1	General		P
T.2	Steady force test, 10 N	(See appended table T.2)	P
T.3	Steady force test, 30 N	(See appended table T.3)	N/A
T.4	Steady force test, 100 N	(See appended table T.4)	P
T.5	Steady force test, 250 N	(See appended table T.5)	N/A
T.6	Enclosure impact test	(See appended table T.6)	N/A
	Fall test		N/A
	Swing test		N/A
T.7	Drop test	(See appended table T.7)	N/A
T.8	Stress relief test.....	(See appended table T.8)	N/A
T.9	Glass Impact Test	(See appended table T.9)	N/A
T.10	Glass fragmentation test		N/A
	Number of particles counted.....		N/A
T.11	Test for telescoping or rod antennas		N/A
	Torque value (Nm)	No such antennas provided within the equipment.	N/A
U	MECHANICAL STRENGTH OF CATHODE RAY TUBES (CRT) AND PROTECTION AGAINST THE EFFECTS OF IMPLOSION		N/A
U.1	General		N/A
	Instructional safeguard :	No CRT provided.	N/A
U.2	Test method and compliance for non-intrinsically protected CRTs		N/A

IEC 62368-1			
Clause	Requirement + Test	Result - Remark	Verdict
U.3	Protective screen		N/A
V	DETERMINATION OF ACCESSIBLE PARTS		P
V.1	Accessible parts of equipment		P
V.1.1	General	No access with test probes to any hazardous parts	P
V.1.2	Surfaces and openings tested with jointed test probes		N/A
V.1.3	Openings tested with straight unjointed test probes		N/A
V.1.4	Plugs, jacks, connectors tested with blunt probe		N/A
V.1.5	Slot openings tested with wedge probe		N/A
V.1.6	Terminals tested with rigid test wire		N/A
V.2	Accessible part criterion		P
X	ALTERNATIVE METHOD FOR DETERMINING CLEARANCES FOR INSULATION IN CIRCUITS CONNECTED TO AN AC MAINS NOT EXCEEDING 420 V PEAK (300 V RMS)		N/A
	Clearance	(See appended table X)	N/A
Y	CONSTRUCTION REQUIREMENTS FOR OUTDOOR ENCLOSURES		N/A
Y.1	General		N/A
Y.2	Resistance to UV radiation		N/A
Y.3	Resistance to corrosion		N/A
Y.3	Resistance to corrosion		N/A
Y.3.1	Metallic parts of outdoor enclosures are resistant to effects of water-borne contaminants by		N/A
Y.3.2	Test apparatus		N/A
Y.3.3	Water – saturated sulphur dioxide atmosphere		N/A
Y.3.4	Test procedure		N/A
Y.3.5	Compliance		N/A
Y.4	Gaskets		N/A
Y.4.1	General		N/A
Y.4.2	Gasket tests		N/A
Y.4.3	Tensile strength and elongation tests		N/A
	Alternative test methods		N/A
Y.4.4	Compression test		N/A
Y.4.5	Oil resistance		N/A
Y.4.6	Securing means	(See Annex P.4)	N/A
Y.5	Protection of equipment within an outdoor enclosure		N/A

IEC 62368-1			
Clause	Requirement + Test	Result - Remark	Verdict
Y.5.1	General		N/A
Y.5.2	Protection from moisture		N/A
	Relevant tests of IEC 60529 or Y.5.3 :		N/A
Y.5.3	Water spray test		N/A
Y.5.4	Protection from plants and vermin		N/A
Y.5.5	Protection from excessive dust		N/A
Y.5.5.1	General		N/A
Y.5.5.2	IP5X equipment		N/A
Y.5.5.3	IP6X equipment		N/A
Y.6	Mechanical strength of enclosures		N/A
Y.6.1	General		N/A
Y.6.2	Impact test :	(See Table T.6)	N/A

IEC 62368-1			
Clause	Requirement + Test	Result - Remark	Verdict

5.2	TABLE: Classification of electrical energy sources						P
Supply Voltage	Location (e.g. circuit designation)	Test conditions	Parameters				ES Class
			U (V)	I (mA)	Type ¹⁾	Additional Info ²⁾	
Model: GTM961200P12054-T2							
264Va.c. 60Hz	Primary circuits supplied by a.c. mains supply	Normal	264V	--	--	--	ES3
		Abnormal	264V	--	--	--	
		Single fault	264V	--	--	--	
264Va.c. 60Hz	T1 secondary pin 9 to B	Normal	117Vpk	--	--	60Hz	ES3
264Va.c. 60Hz	T1 secondary (Pin B and D54)	Normal	57.2Vdc	--	--	DC	ES1
		Single fault: D54 short-circuit	0	--	--	--	
Supplementary information:							
1) Type: Steady state (SS), Capacitance (CP), Single pulse (SP), Repetitive pulses (RP), etc.							
2) Additional Info: Frequency, Pulse duration, Pulse off time, Capacitance value, etc.							
3) Input voltage: 264Vac, 60Hz							

5.4.1.8	TABLE: Working voltage measurement				P
Location	RMS voltage (V)	Peak voltage (V)	Frequency (Hz)	Comments	
Between L and N before fuse	240	340	<30kHz	--	
Between transformer (T1) pins	277	540	60.4Hz	--	
Between the pins of bridged capacitor	240	340	60.4Hz	--	
Supplementary information:					

5.4.1.10.2	TABLE: Vicat softening temperature of thermoplastics			N/A
Method.....: ISO 306 / B50			—	
Object/ Part No./Material	Manufacturer/trademark	Thickness (mm)	T softening (°C)	
Supplementary information:				

IEC 62368-1			
Clause	Requirement + Test	Result - Remark	Verdict

5.4.1.10.3 TABLE: Ball pressure test of thermoplastics					P
Allowed impression diameter (mm)				≤ 2 mm	—
Object/Part No./Material	Manufacturer/trademark	Thickness (mm)	Test temperature (°C)	Impression diameter (mm)	
Enclosure (C2950)	SABIC INNOVATIVE PLASTICS B V	2.0	125	1.3	
Enclosure (PC940)	SABIC INNOVATIVE PLASTICS US L L C	2.0	125	1.2	
Enclosure (945)	SABIC INNOVATIVE PLASTICS B V	2.0	125	1.2	
Bobbin (T375J)	CHANG CHUN PLASTICS CO LTD	0.45	125	0.8	
Bobbin (T375HF)	CHANG CHUN PLASTICS CO LTD	0.45	125	0.8	
Bobbin (4130)	CHANG CHUN PLASTICS CO LTD	0.74	125	1.0	
Bobbin (PM-9820)	SUMITOMO BAKELITE CO LTD	0.45	125	0.8	
Bobbin (CP-J-8800)	HITACHI CHEMICAL CO LTD	0.45	125	0.8	
Supplementary information:					

5.4.2, 5.4.3 TABLE: Minimum Clearances/Creepage distance								P
Clearance (cl) and creepage distance (cr) at/of/between:	U _p (V)	U _{rms} (V)	Freq ¹⁾ (Hz)	Required cl (mm)	cl (mm)	E.S. ²⁾ (V)	Required cr (mm)	cr (mm)
GT*96900P series, GT*961200P series								
L to N before fuse (FI)	340	240	<30 kHz	2.3	3.6	--	2.8	3.6
Two poles of fuse (FI)	340	240	<30 kHz	2.3	2.9	--	2.8	2.9
CY1 Primary circuits to secondary circuits (BI)	340	240	60.4 kHz	2.3	5.4	--	2.8	5.4
CY2 Primary circuits to secondary circuits (SI)	340	240	60.4 kHz	2.3	4.4	--	2.8	4.4
Primary to functional earth (Class I) (RI)	340	240	<30 kHz	4.5	6.2	--	5.6	6.2

IEC 62368-1								
Clause	Requirement + Test			Result - Remark				Verdict
Live parts to Enclosure parts (RI)	340	240	<30 kHz	4.5	8.0	--	5.6	8.0
Live parts to accessible parts (RI)	340	240	60.4 kHz	4.5	6.9	--	5.6	6.9
U2 Primary circuits to secondary circuits (RI)	340	240	60.4 kHz	4.5	8.0	--	5.6	8.0
Primary circuit to secondary circuits (PCB trace under T1) (RI)	540	277	60.4 kHz	4.5	11.0	--	5.6	11.0
Transformer Primary winding to secondary winding (RI)	540	277	60.4 kHz	4.5	11.7	--	5.6	11.7
Transformer Primary winding to core (RI)	540	277	60.4 kHz	4.5	9.5	--	5.6	9.5
GT*41133 series								
Between L and N before fuse for adapter model (FI)	340	240	<30 kHz	2.3	4.1	--	2.8	4.1
Between fuse two ends for adapter model (FI)	340	240	<30 kHz	2.3	3.0	--	2.8	3.0
Between L and N before fuse for open frame model (FI)	340	240	60.4 kHz	2.3	4.2	--	2.8	4.2
Between fuse two ends for open frame model (FI)	340	240	60.4 kHz	2.3	3.6	--	2.8	3.6
Between primary circuits to PE terminal (RI)	340	240	<30 kHz	4.5	6.0	--	5.6	6.0
Between two pins of CY1 on PCB trace (BI)	340	240	60.4 kHz	4.5	6.0	--	5.6	6.0
Between two pins of CY2 on PCB trace (SI)	340	240	60.4 kHz	4.5	6.0	--	5.6	6.0
Primary circuit to secondary circuits (PCB trace under U1) (RI)	340	240	60.4 kHz	4.5	8.2	--	5.6	8.2
Between primary circuits to accessible enclosure for adapter model only(RI)	340	240	<30 kHz	4.5	8.0	--	5.6	8.0
Between primary heatsink to secondary circuits(RI)	340	240	60.4 kHz	4.5	8.0	--	5.6	8.0

IEC 62368-1								
Clause	Requirement + Test				Result - Remark			Verdict
Between primary circuits to secondary heatsink(RI)	340	240	60.4 kHz	4.5	8.0	--	5.6	8.0
Supplementary information:								
1) Only for frequency above 30 kHz								
2) Complete Electric Strength voltage (E.S. (V) when 5.4.2.4 applied)								

5.4.4.2	TABLE: Minimum distance through insulation				P
Distance through insulation (DTI) at/of	Peak voltage (V)	Insulation	Required DTI (mm)	Measured DTI (mm)	
Enclosure	340	RI	0.4	See appended table 4.1.2	
Bobbin of T1	540	RI	0.4	See appended table 4.1.2	
Insulation tape on T1 and secondary heat-sink	540	RI	2 layers	See appended table 4.1.2	
Supplementary information:					

5.4.4.9	TABLE: Solid insulation at frequencies >30 kHz					N/A
Insulation material	E_P	Frequency (kHz)	K_R	Thickness d (mm)	Insulation	V_{PW} (Vpk)
Supplementary information:						

5.4.9	TABLE: Electric strength tests			P
Test voltage applied between:	Voltage shape (Surge, Impulse, AC, DC, etc.)	Test voltage (V)	Breakdown Yes / No	
Line to Neutral (with fuse disconnect)(BI)	DC	2500	NO	
Primary circuit to body (RI)	DC	4000	NO	
Primary circuit to functional earth (RI)	DC	4000	No	
Primary circuit to secondary circuit (RI)	DC	4000	No	
Primary winding to secondary winding of T1 (RI)	DC	4000	No	
Primary winding to core (RI)	DC	4000	No	

IEC 62368-1			
Clause	Requirement + Test	Result - Remark	Verdict
Insulation tape around transformer per layer (RI)	DC	4000	No
Insulation sheet (RI)	DC	4000	No
Supplementary information:			

5.5.2.2	TABLE: Stored discharge on capacitors					P
Location	Supply voltage (V)	Operating and fault condition ¹⁾	Switch position	Measured voltage (Vpk)	ES Class	
AC inlet	264	Normal	No switch	20V	ES1	
AC inlet	264	S (R1 open)	No switch	116V	ES2	
AC inlet	264	S (R1A open)	No switch	116V	ES2	
Supplementary information:						
X-capacitors installed for testing: CX1: Max. 0.22 μ F						
[x] bleeding resistor rating: R1=R2=2M Ω R1A=R2A=4.7M Ω						
[] ICX:						
1) Normal operating condition (e.g., normal operation, or open fuse), SC= short circuit, OC= open circuit						

5.6.6	TABLE: Resistance of protective conductors and terminations				P
Location	Test current (A)	Duration (min)	Voltage drop (V)	Resistance (Ω)	
GND pin to secondary	40A	2	1.44	0.036	
Supplementary information:					
For Class I construction					

5.7.4	TABLE: Unearthed accessible parts					P
Location	Operating and fault conditions	Supply Voltage (V)	Parameters			ES class
			Voltage (V _{rms} or V _{pk})	Current (A _{rms} or A _{pk})	Freq. (Hz)	
Model: GTM96900P9012-T2						
L/N to output	Normal	264	--	0.11mA _{pk}	60	ES1
	Abnormal: Overload		--	0.11mA _{pk}	60	ES1
	Single fault:		--	0.11mA _{pk}	60	ES1

IEC 62368-1						
Clause	Requirement + Test		Result - Remark			Verdict
	R12 SC					
L/N to enclosure	Normal	264	--	0.08mApk	60	ES1
	Abnormal: Overload		--	0.08mApk	60	ES1
	Single fault: R12 SC		--	0.08mApk	60	ES1
Model: GTM96900P9015-T3						
L/N to output	Normal	264	--	0.07mApk	60	ES1
	Abnormal: Overload		--	0.07mApk	60	ES1
	Single fault: R12 SC		--	0.07mApk	60	ES1
L/N to enclosure	Normal	264	--	0.04mApk	60	ES1
	Abnormal: Overload		--	0.04mApk	60	ES1
	Single fault: R12 SC		--	0.04mApk	60	ES1
Model: GTM96900P9054-T2						
L/N to output	Normal	264	--	0.07mApk	60	ES1
	Abnormal: Overload		--	0.07mApk	60	ES1
	Single fault: R12 SC		--	0.07mApk	60	ES1
L/N to enclosure	Normal	264	--	0.04mApk	60	ES1
	Abnormal: Overload		--	0.04mApk	60	ES1
	Single fault: R12 SC		--	0.04mApk	60	ES1
Supplementary information:						
Abbreviation: SC= short circuit; OC= open circuit						

5.7.5	TABLE: Earthed accessible conductive part				N/A
Supply voltage (V)	264Vac				—
Phase(s)	[x] Single Phase; [] Three Phase: [] Delta [] Wye				
Power Distribution System	[x] TN [] TT [] IT				
Location	Fault Condition No in IEC	Touch current	Comment		

IEC 62368-1			
Clause	Requirement + Test	Result - Remark	Verdict
	60990 clause 6.2.2	(mA)	
L, N to output terminal(Class I)	1 (e closed, normal and reverse polarity p)		
L, N to output terminal(Class I)	2* (netural open (switch n), earth intact and normal polarity, again in reverse polarity (switch p)		
L, N to output terminal(Class I, CY1 short circuit)	1 (e closed, normal and reverse polarity p)		
L, N to output terminal(Class I, CY1 short circuit)	2* (netural open (switch n), earth intact and normal polarity, again in reverse polarity (switch p)		
L, N to output terminal(Class II)	1 (e closed, normal and reverse polarity p)		
L, N to output terminal(Class II)	2* (netural open (switch n), earth intact and normal polarity, again in reverse polarity (switch p)		
L, N to output terminal(Class II, CY1 short circuit)	1 (e closed, normal and reverse polarity p)		
L, N to output terminal(Class II, CY1 short circuit)	2* (netural open (switch n), earth intact and normal polarity, again in reverse polarity (switch p)		
--	3 (for IT system, each phase conductor faulted to earth, one at a time (switch g)	--	
--	4 (for three-phase, each phase conductor open, one at a time switches l)	--	
--	5 (IT power system or three phase delta system)	--	
--	6 (three-phase for use on centre-earthed dalta supply system)	--	
--	8 (incidental electrically connected to other parts)	--	
L, N to output terminal(Class I)	1 (e open, normal and reverse polarity p)		
L, N to output terminal(Class I)	2* (netural open (switch n), earth intact and normal polarity, again in		

IEC 62368-1			
Clause	Requirement + Test	Result - Remark	Verdict

	reverse polarity (switch p)		
L, N to output terminal(Class I, CY1 short circuit)	1 (e open, normal and reverse polarity p)		
L, N to output terminal(Class I, CY1 short circuit)	2* (netural open (switch n), earth intact and normal polarity, again in reverse polarity (switch p)		
L, N to output terminal(Class II)	1 (e open, normal and reverse polarity p)		
L, N to output terminal(Class II)	2* (netural open (switch n), earth intact and normal polarity, again in reverse polarity (switch p)		
L, N to output terminal(Class II, CY1 short circuit)	1 (e open, normal and reverse polarity p)		
L, N to output terminal(Class II, CY1 short circuit)	2* (netural open (switch n), earth intact and normal polarity, again in reverse polarity (switch p)		

Supplementary Information:

- [1] Supply voltage is the anticipated maximum Touch Voltage
 [2] Earthed neutral conductor [Voltage differences less than 1% or more]
 [3] Specify method used for measurement as described in IEC 60990 sub-clause 4.3
 [4] IEC60990, sub-clause 6.2.2.7, Fault 7 not applicable.
 [5] (*) IEC60990, sub-clause 6.2.2.2 is not applicable if switch or disconnect device (e.g., appliance coupler) provided.
 a) Not considered IT power system.
 b) Not three phase equipment.
 c) Not IT power system or three phase delta system.
 d) Not three-phase for use on centre-earthed dalta supply system.
 e) Not such parts.

5.8	TABLE: Backfeed safeguard in battery backed up supplies						N/A
Location	Supply voltage (V)	Operating and fault condition	Time (s)	Open-circuit voltage (V)	Touch current (A)	ES Class	
Supplementary information:							
Abbreviation: SC= short circuit, OC= open circuit							

6.2.2	TABLE: Power source circuit classifications					P
Location	Operating and fault condition	Voltage (V)	Current (A)	Max. Power ¹⁾	Time (S)	PS class

IEC 62368-1						
Clause	Requirement + Test	Result - Remark			Verdict	
				(W)		
Primary circuits	Normal	--	--	--	--	PS3 (Declared)
Model: GTM96900P9012-T2						
Output + to -	Normal	12.04	7.8	86.2	5	PS2
Output + to -	*Single fault: (U2 pin 1 OC)	0*	0*	0*	3	PS1
Output + to -	*Single fault: (U2 pin 3-4 SC)	0*	0*	0*	3	PS1
Model: GTM96900P9015-T3						
Output + to -	Normal	15.09	6.4	93.2	5	PS2
Output + to -	*Single fault: (U2 pin 1 OC)	0*	0*	0*	3	PS1
Output + to -	*Single fault: (U2 pin 3-4 SC)	0*	0*	0*	3	PS1
Model: GTM96900P9054-T2						
Output + to -	Normal	54.1	1.73	94.8	5	PS2
Output + to -	*Single fault: (U2 pin 1 OC)	0*	0*	0*	3	PS1
Output + to -	*Single fault: (U2 pin 3-4 SC)	0*	0*	0*	3	PS1
Supplementary information:						
Abbreviation: SC= short circuit; OC= open circuit						
1) Measured after 3 s for PS1 and measured after 5 s for PS2 and PS3.						
2) * Unit shutdown immediately, no hazards;						
3) # Fuse opened immediately, no hazards.						

6.2.3.1	TABLE: Determination of Arcing PIS				P
Location	Open circuit voltage after 3 s (Vpk)	Measured r.m.s current (A)	Calculated value	Arcing PIS? Yes / No	
See below	--	--	--	--	
Supplementary information:					
The primary components and T1 having soldered pins in mains circuit (>50V peak) are considered as arcing PIS.					
An Arcing PIS requires a minimum of 50 V (peak) a.c. or d.c. An Arcing PIS is established when the product of the open circuit voltage (V_p) and normal operating condition rms current (I_{rms}) is greater than 15.					

IEC 62368-1			
Clause	Requirement + Test	Result - Remark	Verdict

6.2.3.2	TABLE: Determination of resistive PIS			P
Location	Operating and fault condition	Dissipate power (W)	Arcing PIS? Yes / No	
--	--	--	Yes	
Supplementary information:				
Abbreviation: SC= short circuit; OC= open circuit				
All power dissipating components in primary and secondary circuit are considered as resistive PIS				
A combination of voltmeter, VA and ammeter IA may be used instead of a wattmeter.				
A Resistive PIS: (a) dissipates more than 15 W, measured after 30 s of normal operation, <u>or</u> (b) under single fault conditions has either a power exceeding 100 W measured immediately after the introduction of the fault if electronic circuits, regulators or PTC devices are used, or has an available power exceeding 15 W measured 30 s after introduction of the fault.				

8.5.5	TABLE: High pressure lamp				N/A
Lamp manufacturer	Lamp type	Explosion method	Longest axis of glass particle (mm)	Particle found beyond 1 m Yes / No	
Supplementary information:					

9.6	TABLE: Temperature measurements for wireless power transmitters							N/A
Supply voltage (V)..... :								—
Max. transmit power of transmitter (W)..... :								—
Foreign objects	w/o receiver and direct contact		with receiver and direct contact		with receiver and at distance of 2 mm		with receiver and at distance of 5 mm	
	Object (°C)	Ambient (°C)	Object (°C)	Ambient (°C)	Object (°C)	Ambient (°C)	Object (°C)	Ambient (°C)
Supplementary information:								

IEC 62368-1			
Clause	Requirement + Test	Result - Remark	Verdict

5.4.1.4, 9.3, B.1.5, B.2.6	TABLE: Temperature measurements		P
Supply voltage (V)..... :	90	264	—
Ambient temperature during test T_{amb} (°C) :	40	40	—
Maximum measured temperature T of part/at:	T (°C)		Allowed T_{max} (°C)
Model: GTM41133-9016-4.0-T2			
LF1	71.3	62.0	110
X capacitor	79.5	68.9	100
LF2	88.7	74.8	130
PCB near BD1	94.3	76.2	130
L2	92.5	80.5	110
L1	83.4	73.5	110
C4 body	91.7	86.8	105
PCB near HS1	89.5	83.7	130
PCB near HS2	79.9	76.2	130
Transformer core	102.1	97.1	110
Transformer winding	100.2	98.7	110
U1 body	88.1	84.8	100
CY1 body	92.9	89.6	125
Output cord	59.1	57.5	80
External plastic enclosure	56.5	50.6	77
Enclosure inside above Transformer	64.6	77.5	Ref.
Model: GTM96900P9012-T2			
AC Inlet	59.8	54.6	70
Varistor MOV1	70.9	60.9	85
Line chock of LF1	83.4	69.1	110
X-capacitor CX1	83.9	68.9	100
Line chock of LF2	94.4	72.7	110
PCB under BD1	84.9	70.3	130
Line chock of L1	92.0	75.3	110
Line chock of L2	104.5	80.1	110

IEC 62368-1				
Clause	Requirement + Test	Result - Remark	Verdict	
	PCB under Q1	97.5	80.4	130
	PCB under Q3	93.7	80.1	130
	E-capacitor C4	94.6	80.9	105
	Opto coupler U2	97.7	88.4	100
	T1 coil	102.0	91.0	110
	T1 core	97.1	85.7	110
	Line chock of L3	98.7	88.0	110
	Y-capacitor CY1	79.8	71.7	125
	Y-capacitor CY2	85.2	78.5	125
	Line chock of L4	85.7	80.5	110
	E-capacitor C41	93.4	86.8	105
	PCB under D53	100.5	92.5	130
	Output wire	70.4	67.3	80
	Plastic enclosure inside near T1	85.8	74.7	Ref.
	Plastic enclosure outside near T1	71.3	66.1	77
Model: GTM96900P9015-T3				
	AC Inlet	55.9	58.1	70
	PE wire	73.7	71.9	105
	Varistor MOV1	60.1	62.4	85
	Line chock of LF1	68.1	70.0	110
	X-capacitor CX1	68.8	71.0	100
	Line chock of LF2	70.8	73.2	110
	PCB under BD1	68.6	72.2	130
	Line chock of L1	74.2	76.6	110
	Line chock of L2	76.3	78.9	110
	PCB under Q1	77.9	80.2	130
	PCB under Q3	78.2	80.3	130
	E-capacitor C4	77.7	79.9	105
	Optocoupler U2	86.0	87.8	100
	T1 coil	91.0	93.0	110
	T1 core	90.3	92.5	110
	Line chock of L3	90.3	92.2	110
	Y-capacitor CY1	70.1	74.3	125
	Y-capacitor CY2	76.0	79.5	125

IEC 62368-1				
Clause	Requirement + Test	Result - Remark	Verdict	
	Line chock of L4	78.2	80.5	110
	E-capacitor C41	83.8	85.2	105
	PCB under D53	88.1	89.7	130
	Output wire	65.1	67.9	80
	Plastic enclosure inside near T1	75.3	78.5	Ref.
	Plastic enclosure outside near T1	64.0	70.4	77
Model: GTM96900P9054-T2				
	AC Inlet	49.3	49.2	70
	Varistor MOV1	66.7	57.8	85
	Line chock of LF1	76.7	64.6	110
	X-capacitor CX1	82.8	69.2	100
	Line chock of LF2	89.1	71.8	110
	PCB under BD1	41.4	39.9	130
	Line chock of L1	92.4	73.1	110
	Line chock of L2	91.8	74.7	110
	PCB under Q1	95.0	79.0	130
	PCB under Q3	94.1	77.2	130
	E-capacitor C4	89.0	75.7	105
	Optocoupler U2	87.6	79.2	100
	T1 coil	98.2	87.4	110
	T1 core	95.7	80.3	110
	Line chock of L3	94.6	85.2	110
	Y-capacitor CY1	73.1	66.1	125
	Y-capacitor CY2	75.0	68.9	125
	Line chock of L4	70.8	66.0	110
	E-capacitor C41	77.5	72.4	105
	PCB under D53	82.1	76.2	130
	Output wire	58.1	56.5	80
	Plastic enclosure inside near T1	84.5	72.0	Ref.
	Plastic enclosure outside near T1	64.8	58.3	77
Model: GTM961200P11112-T3				
	AC Inlet	59.3	54.8	70
	PE wire	96.8	87.8	105
	Varistor MOV1	69.5	57.9	85

IEC 62368-1				
Clause	Requirement + Test	Result - Remark	Verdict	
	Line chock of LF1	107.7	67.3	110
	X-capacitor CX1	91.6	73.6	100
	Line chock of LF2	101.6	80.4	110
	PCB under BD1	100.8	79.2	130
	Line chock of L1	106.8	81.6	110
	Line chock of L2	104.3	84.5	110
	PCB under Q1	110.3	88.0	130
	PCB under Q3	104.3	84.5	130
	E-capacitor C4	101.0	87.2	105
	Optocoupler U2	96.7	89.4	100
	T1 coil	107.3	93.2	110
	T1 core	107.2	92.3	110
	Line chock of L3	106.4	89.3	110
	Y-capacitor CY1	95.0	81.5	125
	Y-capacitor CY2	98.2	85.8	125
	Line chock of L4	105.2	94.5	110
	E-capacitor C41	101.3	92.2	105
	PCB under D53	110.9	96.9	130
	Output wire	77.6	75.8	80
	Plastic enclosure inside near T1	88.0	84.4	Ref.
	Plastic enclosure outside near T1	73.4	72.5	77
Model: GTM961200P12015-T3				
	AC Inlet	58.3	55.7	70
	PE wire	99.1	90.6	105
	Varistor MOV1	65.6	50.7	85
	Line chock of LF1	84.2	60.1	110
	X-capacitor CX1	89.3	66.0	100
	Line chock of LF2	104.6	70.5	110
	PCB under BD1	107.8	74.4	130
	Line chock of L1	100.3	71.5	110
	Line chock of L2	106.4	91.8	110
	PCB under Q1	104.8	77.1	130
	PCB under Q3	103.8	74.4	130
	E-capacitor C4	102.0	79.3	105

IEC 62368-1				
Clause	Requirement + Test	Result - Remark	Verdict	
Optocoupler U2		97.3	78.8	100
T1 coil		104.9	94.8	110
T1 core		103.1	87.5	110
Line chock of L3		107.7	91.7	110
Y-capacitor CY1		91.3	74.4	125
Y-capacitor CY2		91.8	77.1	125
Line chock of L4		82.7	69.5	110
E-capacitor C41		90.2	81.5	105
PCB under D53		102.3	88.8	130
Output wire		67.7	60.0	80
Plastic enclosure inside near T1		82.5	72.1	Ref.
Plastic enclosure outside near T1		65.2	60.7	77
Model: GTM961200P12054-T2				
AC Inlet		53.2	47.4	70
Varistor MOV1		68.5	54.2	85
Line chock of LF1		81.5	62.8	110
X-capacitor CX1		88.4	66.7	100
Line chock of LF2		97.7	70.7	110
PCB under BD1		99.7	73.3	130
Line chock of L1		105.3	75.5	110
Line chock of L2		100.6	74.4	110
PCB under Q1		110.2	81.7	130
PCB under Q3		104.2	80.8	130
E-capacitor C4		96.3	75.1	105
Optocoupler U2		95.6	81.9	100
T1 coil		100.9	93.9	110
T1 core		93.0	89.3	110
Line chock of L3		107.2	101.6	110
Y-capacitor CY1		91.3	78.5	125
Y-capacitor CY2		87.2	75.5	125
Line chock of L4		79.2	71.2	110
E-capacitor C41		87.6	77.8	105
PCB under D53		90.7	80.1	130
Output wire		62.3	58.6	80

IEC 62368-1			
Clause	Requirement + Test	Result - Remark	Verdict

Plastic enclosure inside near T1		82.8		75.6		Ref.	
Plastic enclosure outside near T1		69.5		68.3		77	
Plastic enclosure outside near T1	64.0	70.4	t ₂ (°C)	R ₂ (Ω)	T (°C)	Allowed T _{max} (°C)	Insulation class
--	--	--	--	--	--	--	--
Supplementary information:							
* Temperature limit for TS1 of accessible enclosure according to Table 38.							
Note 1: The apparatus was submitted and evaluated for maximum manufacturer's recommended ambient (T _{ma}) of 40°C.							
Note 2: The temperatures were measured under the worse case normal mode defined in clause B.2.1.							
Note 3. Temperature limits are calculated as follows: Winding components providing safety isolation: Class B → T _{max} = 120 - 10=110°C							
Note 4: The enclosure was tested at ambient temperature of 25°C.							

B.2.5		TABLE: Input test						P
U (V)	Hz	I (A)	I rated (A)	P (W)	P rated (W)	Fuse No	I fuse (A)	Condition/status
Model: GTM96900P9012-T2 / GTM96900P9012-T3								
90	50	1.118	--	100.5	--	F1, F2	1.118	Max normal load
100	50	0.998	1.5	99.92	--	F1, F2	0.998	
240	50	0.428	1.5	98.00	--	F1, F2	0.428	
264	50	0.393	--	97.87	--	F1, F2	0.393	
90	60	1.118	--	100.6	--	F1, F2	1.118	
100	60	1.002	1.5	100.0	--	F1, F2	1.002	
240	60	0.430	1.5	98.10	--	F1, F2	0.430	
264	60	0.395	--	98.03	--	F1, F2	0.395	
Model: GTM96900P9015-T2 / GTM96900P9015-T3								
90	50	1.117	--	100.8	--	F1, F2	1.117	Max normal load
100	50	1.008	1.5	100.1	--	F1, F2	1.008	
240	50	0.429	1.5	98.21	--	F1, F2	0.429	
264	50	0.393	--	98.14	--	F1, F2	0.393	
90	60	1.118	--	100.0	--	F1, F2	1.118	
100	60	1.014	1.5	100.3	--	F1, F2	1.014	
240	60	0.430	1.5	98.36	--	F1, F2	0.430	
264	60	0.396	--	98.28	--	F1, F2	0.396	

IEC 62368-1								
Clause	Requirement + Test				Result - Remark			Verdict
Model GTM96900P9024-T2/ GTM96900P9024-T3								
90	--	1.138	--	101.1	--	F1, F2	1.138	Max normal load
100	--	1.017	1.5	100.3	--	F1, F2	1.017	
240	--	0.436	1.5	98.33	--	F1, F2	0.436	
264	--	0.398	--	98.2	--	F1, F2	0.398	
Model: GTM96900P9054-T2 / GTM96900P9054-T3								
90	50	1.126	--	101.4	--	F1, F2	1.126	Max normal load
100	50	1.009	1.5	100.7	--	F1, F2	1.009	
240	50	0.431	1.5	98.67	--	F1, F2	0.431	
264	50	0.394	--	98.49	--	F1, F2	0.394	
90	60	1.119	--	100.8	--	F1, F2	1.119	
100	60	1.004	1.5	100.1	--	F1, F2	1.004	
240	60	0.431	1.5	98.41	--	F1, F2	0.431	
264	60	0.396	--	98.65	--	F1, F2	0.396	
Model: GTM961200P12015-T2 / GTM961200P12015-T3								
90	50	1.561	--	140.3	--	F1, F2	1.561	Max normal load
100	50	1.381	1.5	138.0	--	F1, F2	1.381	
240	50	0.571	1.5	131.3	--	F1, F2	0.571	
264	50	0.528	--	131.1	--	F1, F2	0.528	
90	60	1.564	--	140.6	--	F1, F2	1.564	
100	60	1.401	1.5	138.6	--	F1, F2	1.401	
240	60	0.582	1.5	131.9	--	F1, F2	0.582	
264	60	0.531	--	131.7	--	F1, F2	0.531	
Model: GTM961200P12054-T2 / GTM961200P12054-T3								
90	50	1.486	--	133.9	--	F1, F2	1.486	Max normal load
100	50	1.332	1.5	132.9	--	F1, F2	1.332	
240	50	0.571	1.5	129.3	--	F1, F2	0.571	
264	50	0.521	--	129.0	--	F1, F2	0.521	
90	60	1.492	--	134.5	--	F1, F2	1.492	
100	60	1.344	1.5	133.5	--	F1, F2	1.344	
240	60	0.573	1.5	129.8	--	F1, F2	0.573	
264	60	0.525	--	129.6	--	F1, F2	0.525	
Model GTM961200P11112-T2 / GTM961200P11112-T3								
90	50	1.395	--	124.1	--	F1, F2	1.395	Max normal

IEC 62368-1								
Clause	Requirement + Test				Result - Remark			Verdict
90	60	1.380	--	123.8	--	F1, F2	1.380	load
100	50	1.238	1.5	123.3	--	F1, F2	1.238	
100	60	1.226	1.5	123.1	--	F1, F2	1.226	
240	50	0.533	1.5	120.6	--	F1, F2	0.533	
240	60	0.533	1.5	120.6	--	F1, F2	0.533	
264	50	0.488	--	120.4	--	F1, F2	0.488	
264	60	0.489	--	120.4	--	F1, F2	0.489	
Model GTM41133-9016-4.0-T2 / GTM41133-9016-4.0-T3								
90	--	1.141	--	104.5	--	FS1, FS2	1.141	Max normal load
100	--	1.029	1.5	103.4	--	FS1, FS2	1.029	
240	--	0.456	1.5	101.5	--	FS1, FS2	0.456	
264	--	0.489	--	101.6	--	FS1, FS2	0.489	
Model: GTM41133-9048-11.0-T2 / GTM41133-9048-11.0-T3								
90	--	1.139	--	102.4	--	FS1, FS2	1.139	Max normal load
100	--	1.019	1.5	101.7	--	FS1, FS2	1.019	
240	--	0.455	1.5	100.6	--	FS1, FS2	0.455	
264	--	0.488	--	100.6	--	FS1, FS2	0.488	
Model: GTM41133-9048-10.5-T2 / GTM41133-9048-10.5-T3								
90	--	1.138	--	102.3	--	FS1, FS2	1.138	Max normal load
100	--	1.019	1.5	101.6	--	FS1, FS2	1.019	
240	--	0.454	1.5	100.5	--	FS1, FS2	0.454	
264	--	0.488	--	100.6	--	FS1, FS2	0.488	
Model: GTM41133-9048-T2 / GTM41133-9048-T3								
90	--	1.137	--	101.3	--	FS1, FS2	1.137	Max normal load
100	--	1.013	1.5	100.6	--	FS1, FS2	1.013	
240	--	0.453	1.5	100.1	--	FS1, FS2	0.453	
264	--	0.486	--	100.2	--	FS1, FS2	0.486	
Supplementary information:								
The maximum measured current under rated voltage did not exceed 110% of the rated current.								

B.3, B.4	TABLE: Abnormal operating and fault condition tests						P
Ambient temperature T_{amb} (°C)..... :	25°C, if not specified						—
Power source for EUT: Manufacturer, model/type, outputrating .. :	Chroma, 61512, 18kVA						—
Component No.	Condition	Supply	Test	Fuse no.	Fuse	Observation	

IEC 62368-1						
Clause	Requirement + Test	Result - Remark			Verdict	
		voltage (V)	time		current (A)	
GT*96900P series, GT*961200P series						
BD1	SC	264	1s	F1, F2	0	Fuse opened immediately no hazard
C2	SC	264	1s	F1, F2	0	Fuse opened immediately no hazard
Q1 pinG-S	SC	264	30min	F1, F2	0.525	Unit work normally no hazard
Q1 pinG-D	SC	264	1s	F1, F2	0	Fuse opened immediately no hazard
Q1 pinD-S	SC	264	1s	F1, F2	0	Fuse opened immediately no hazard
Q2 pinG-S	SC	264	30min	F1, F2	0.017	Unit shutdown immediately recoverable no hazard
Q2 pinG-D	SC	264	1s	F1, F2	0	Fuse opened immediately no hazard
Q2 pinD-S	SC	264	1s	F1, F2	0	Fuse opened immediately no hazard
Q3 pinG-S	SC	264	30min	F1, F2	0.021	Unit shutdown immediately recoverable no hazard
Q3 pinG-D	SC	264	1s	F1, F2	0	Fuse opened immediately no hazard
Q3 pinD-S	SC	264	1s	F1, F2	0	Fuse opened immediately no hazard
T1 pin1-2	SC	264	1s	F1, F2	0	Fuse opened immediately no hazard
T1 pin5-6	SC	264	30min	F1, F2	0.021	Unit shutdown immediately recoverable no hazard
T1 pin 9-B	SC	264	30min	F1, F2	0.027	Unit shutdown immediately recoverable no hazard
T1 pin A-10	SC	264	30min	F1, F2	0.025	Unit shutdown immediately recoverable no hazard
U1 pin3-21	SC	264	30min	F1, F2	0.102	Unit shutdown immediately recoverable no hazard
U1 pin3-8	SC	264	30min	F1, F2	0.528	Unit work normally, no hazard
R12	SC	264	30min	F1, F2	0.525	Unit work normally, no hazard
D54	SC	264	30min	F1, F2	0.021	Unit shutdown immediately recoverable no hazard
C41	SC	264	30min	F1, F2	0.103	Unit shutdown immediately

IEC 62368-1						
Clause	Requirement + Test				Result - Remark	Verdict
						recoverable no hazard
Output	SC	264	30min	F1, F2	0.036	Unit shutdown immediately recoverable no hazard
GT*96900P series						
Output (12V series)	OL	264	1h	F1, F2	Max. 0.418A	Load to 7.8A, EUT protected immediately, no hazards. Temperature recorded: T1 winding = 106 °C
Output (15V series)	OL	264	1h	F1, F2	Max. 0.423A	Load to 6.4A, EUT protected immediately, no hazards. Temperature recorded: T1 winding = 97.4 °C
Output (54V series)	OL	264	1h	F1, F2	Max. 0.419	Load to 1.73A, EUT protected immediately, no hazards. Temperature recorded: T1 winding = 90.6 °C
GT*961200P series						
Output (12V series)	OI	264	3h	F1, F2	Max. 0.637A	Load to 12.65A, EUT protected immediately, no hazards. Temperature recorded: T1 winding = 117.6 °C
Output (15V series)	OL	264	1h	F1, F2	Max. 0.648A	Load to 10.0A, EUT protected immediately, no hazards. Temperature recorded: T1 winding = 120.0 °C
Output (54V series)	OL	264	1h	F1, F2	0.651A	Load to 2.65A, EUT protected immediately, no hazards. Temperature recorded: T1 winding = 109.6 °C
Model: GTM41133-9016-4.0-T2						
C9	Sc	264	30min	FS1, FS2	1.141→ 0.063↔ 0.0384	Unit shut down immediately. No output. No high temperature. No hazard.
T1 sec.	Sc	264	30min	FS1, FS2	1.141→ 0.038	Unit shut down immediately. No output. No high temperature. No hazard.

IEC 62368-1						
Clause	Requirement + Test				Result - Remark	Verdict
U1 sec.	Sc	264	30min	FS1, FS2	1.141→ 0.038↔ 0.052	Unit shut down immediately. No output. No high temperature. No hazard.
Q3	Sc	264	30min	FS1, FS2	1.141→ 0.038↔ 0.052	Unit shut down immediately. No output. No high temperature. No hazard.
DS5	Sc	264	30min	FS1, FS2	1.141→ 1.088	Unit normally works. No high temperature obtained. No hazard.
U1 pri.	Sc	264	30min	FS1, FS2	1.141→ 0.039	Unit shut down immediately. No output. No high temperature. No hazard.
CS1	Sc	264	30min	FS1, FS2	1.141→ 1.106	Unit normally works. No high temperature obtained. No hazard.
D3	Sc	264	30min	FS1, FS2	1.141→ 0.039	Unit shut down immediately. No output. No high temperature. No hazard.
C1	Sc	264	30min	FS1, FS2	1.141→ >6.6→ 0.0	Fuse open immediately. The same result was obtained ten times by repeated test. No hazard at all.
Q1	Sc	264	30min	FS1, FS2	1.141→ >6.6→ 0.0	Fuse open immediately. The same result was obtained ten times by repeated test. No hazard at all.
Output	Ol	264	1h	FS1, FS2	1.97	Load 12.8A, T1 winding: 153.7°C, No hazard.
Supplementary information:						
<p>Test table is provided to record abnormal and fault conditions for all applicable energy sources including Thermal burn injury. Column "Abnormal/Fault." Specify if test condition by indicating "Abnormal" then the condition for a Clause B.3 test or "Single Fault" then the condition for Clause B.4.</p> <p>1) SC: Short-circuited; OC: Open-circuited; OL: Overloaded; BL: Blocked.</p> <p>2) The test result shown all safeguards remained effective and didn't lead to a single fault condition during abnormal operating condition; In addition all safeguards complied with applicable requirements in this standard after restoration of normal operating conditions.</p> <p>3) The test result showed no Class 1 or 2 energy source become Class 3 level during and after single fault condition.</p> <p>4) The overloaded condition is applied according to annex G.5.3.3.</p> <p>Winding Limit for T1: 175-10=165°C</p>						

M.3	TABLE: Protection circuits for batteries provided within the equipment	N/A
------------	---	-----

IEC 62368-1			
Clause	Requirement + Test	Result - Remark	Verdict

Is it possible to install the battery in a reverse polarity position?						—	
Equipment Specification	Charging						
	Voltage (V)				Current (A)		
Manufacturer/type	Battery specification						
	Non-rechargeable batteries			Rechargeable batteries			
	Discharging current (A)	Unintentional charging current (A)	Charging		Discharging current (A)	Reverse charging current (A)	
			Voltage (V)	Current (A)			
Note: The tests of M.3.2 are applicable only when above appropriate data is not available.							
Specified battery temperature (°C)						N/A	
Component No.	Fault condition	Charge/discharge mode	Test time	Temp. (°C)	Current (A)	Voltage (V)	Observation
Supplementary information:							
Abbreviation: SC= short circuit; OC= open circuit NL= no chemical leakage; NS= no spillage of liquid; NE= no explosion; NF= no emission of flame or expulsion of molten metal.							

M.4.2	TABLE: Charging safeguards for equipment containing a secondary lithium battery						N/A
Maximum specified charging voltage (V)						—	
Maximum specified charging current (A)						—	
Highest specified charging temperature (°C)							
Lowest specified charging temperature (°C)							
Battery manufacturer/type	Operating and fault condition	Measurement			Observation		
		Charging voltage (V)	Charging current (A)	Temp. (°C)			
Supplementary information:							
Abbreviation: SC= short circuit; OC= open circuit; MSCV= maximum specified charging voltage; MSCC= maximum specified charging current; HSCT= highest specified charging temperature; LSCT= lowest specified charging temperature							

Q.1	TABLE: Circuits intended for interconnection with building wiring (LPS)						P
Output Circuit	Condition	U _{oc} (V)	Time (s)	I _{sc} (A)		S (VA)	
				Meas.	Limit	Meas.	Limit

IEC 62368-1							
Clause	Requirement + Test	Result - Remark					Verdict
Model: GTM96900P9012-T2							
Output	Normal condition	12.04	-	7.8	8	86.2	100
Output	U2 pin1 O-C	0	-	0	8.0	0	100
Output	U2 pin3-4 S-C	0	-	0	8.0	0	100
Output	R12 S-C	12.04	-	7.8	8	86.2	100
Model: GTM96900P9015-T3							
Output	Normal condition	15.06	-	6.4	8	94.8	100
Output	U2 pin1 O-C	0	-	0	8.0	0	100
Output	U2 pin3-4 S-C	0	-	0	8.0	0	100
Output	R12 S-C	15.06	-	6.4	8	94.8	100
Model: GTM96900P9054-T2							
Output	Normal condition	54.10	-	1.73	8	93.2	100
Output	U2 pin1 O-C	0	-	0	8.0	0	100
Output	U2 pin3-4 S-C	0	-	0	8.0	0	100
Output	R12 S-C	54.10	-	1.73	8	93.2	100
Supplementary Information:							
Note: Measured UOC (V) with all load circuits disconnected SC=Short circuit							

T.2, T.3, T.4, T.5	TABLE: Steady force test						P
Location/Part	Material	Thickness (mm)	Probe	Force (N)	Test Duration (s)	Observation	
Enclosure top, closed to transformer (T.4)	Plastics	2.0	-	100	5	Enclosure remained intact, no crack/ opening developed. Internal ES3, TS3 were not accessible after test. No insulation breakdown.	

IEC 62368-1							
Clause	Requirement + Test				Result - Remark		Verdict
Enclosure side (T.4)	Same as above	2.0	-	100	5	Enclosure remained intact, no crack/ opening developed. Internal ES3, TS3 were not accessible after test. No insulation breakdown.	
Enclosure bottom, closed to transformer (T.4)	Same as above	2.0	-	100	5	Enclosure remained intact, no crack/ opening developed. Internal ES3, TS3 were not accessible after test. No insulation breakdown.	
Internal components (T.2)	-	-	-	10	5	No insulation breakdown. No reduction the clearances and creepage distances	
Supplementary information:							

T.6, T.9	TABLE: Impact test					N/A
Location/Part	Material	Thickness (mm)	Height (mm)	Observation		
Supplementary information:						

T.7	TABLE: Drop test					P
Location/Part	Material	Thickness (mm)	Height (mm)	Observation		
Three side of enclosure	Hardwood	2mm	1000mm	After the drop test, no open was found for the enclosure		
Supplementary information:						

IEC 62368-1			
Clause	Requirement + Test	Result - Remark	Verdict

T.8	TABLE: Stress relief test					P
Location/Part	Material	Thickness (mm)	Oven Temperature (°C)	Duration (h)	Observation	
Enclosure	Plastics	2.0mm	104	7	Enclosure remained intact, no cracking/opening developed in the enclosure joint. Internal ES3, TS3 were not accessible after test. No insulation breakdown.	
Supplementary information:						

X	TABLE: Alternative method for determining minimum clearances distances			N/A
Clearance distanced between:	Peak of working voltage (V)	Required cl (mm)	Measured cl (mm)	
Supplementary information:				

IEC 62368-1			
Clause	Requirement + Test	Result - Remark	Verdict

4.1.2 TABLE: Critical components information					
Object / part No.	Manufacturer/ trademark	Type / model	Technical data	Standard	Mark(s) of conformity ¹⁾
Enclosure (all parts)	SABIC INNOVATIVE PLASTICS B V	C2950	PC/ABS, Min. V-0, Min. thickness: 2.0mm, 85°C	IEC 62368-1 UL 94 UL 746 A/B/C/D	Tested with appliance UL E45329
Alt. use	SABIC INNOVATIVE PLASTICS US L L C	PC940	PC, V-0 Min. thickness: 2.0mm, 120°C	IEC 62368-1 UL 94 UL 746 A/B/C/D	Tested with appliance UL E121562
Alt. use	SABIC INNOVATIVE PLASTICS B V	945	PC, Min V-0, Min. thickness: 2.0mm, 120°C	IEC 62368-1 UL 94 UL 746 A/B/C/D	Tested with appliance UL E45329 UL E207780
Appliance inlet CN1 Class I units(C6 type)	Zhejiang LECI Electronics Co., Ltd.	DB-6	2.5A, 250Vac	IEC/EN 60320-1	VDE 40032465
Alt. use	Rich Bay Co., Ltd.	R-30790, R-307	2.5A, 250Vac	IEC/EN 60320-1	VDE 40030381
Alt. use	Sun Fair Electric Wire & Cable (HK) Co. Ltd.	S-02	2.5A, 250Vac	IEC/EN 60320-1	VDE 40034448
Alt. use	TECX-UNIONS Technology Corporation	TU-333	2.5A, 250Vac	IEC/EN 60320-1	ENEC 00633
Alt. use	Rong Feng Industrial Co., Ltd.	RF-190	2.5A, 250Vac	IEC/EN 60320-1	VDE 40030379
Alt. use	Zhe Jiang Bei Er jia	ST-A04-002	2.5A, 250Vac	IEC/EN 60320-1	VDE 40016045
Appliance inlet CN1 Class I units (C14 type)	Zhejiang LECI Electronics Co., Ltd.	DB-14	10A, 250Vac	IEC/EN 60320-1	VDE 40032137
Alt. use	Rich Bay Co., Ltd.	R-301SN	10A, 250Vac	IEC/EN 60320-1	VDE 40030228
Alt. use	TECX-UNIONS Technology Corporation	TU-301-S, TU-301-SP	10A, 250Vac	IEC/EN 60320-1	ENEC 00647
Alt. use	Rong Feng Industrial Co., Ltd.	SS-120	10A, 250Vac	IEC/EN 60320-1	VDE 40028101

IEC 62368-1					
Clause	Requirement + Test			Result - Remark	Verdict
Alt. use	Zhe Jiang Bei Er jia	ST-A01-003J	10A, 250Vac	IEC/EN 60320-1	VDE 40013388
Appliance inlet CN1 Class II units (C8 type)	Zhejiang LECI Electronics Co., Ltd.	DB-8	2.5A, 250Vac	IEC/EN 60320-1	VDE 40032028
Alt. use	Rich Bay Co., Ltd.	R-201SN90	2.5A, 250Vac	IEC/EN 60320-1	VDE 40030384
Alt. use	Sun Fair Electric Wire & Cable (HK)Co. Ltd.	S-01	2.5A, 250Vac	IEC/EN 60320-1	VDE 40034449
Alt. use	TECX-UNIONS Technology Corporation	SO-222	2.5A, 250Vac	IEC/EN 60320-1	VDE 40043268
Alt. use	Rong Feng Industrial Co., Ltd.	RF-180	2.5A, 250Vac	IEC/EN 60320-1	VDE 40030168
Alt. use	Zhe Jiang Bei Er jia	ST-A03-005	2.5A, 250Vac	IEC/EN 60320-1	VDE 40014833
Appliance inlet CN1 Class II units (C18 type) (For: GT*96900P series, GT*961200P series)	Rong Feng Industrial Co., Ltd	SS-120	10A, 250V	IEC/EN 60320-1	VDE 40028101
Alt. use	HCR Electronics Co Ltd.	SK05	10A, 250V	IEC/EN 60320-1	CB:NO69247
Alt. use	Rich Bay Co., Ltd.	R-301SN	10A,250V	IEC/EN 60320-1	VDE 40030228
PCB	WALEX ELECTRONIC (WUXI) CO LTD	T2, T2A, T2B T4	Min. 1.6 mm thickness, min. V-0, 130°C	IEC 62368-1 UL 796	Tested with appliance UL E154355
Alt. use	SUZHOU CITY YILIHUA ELECTRONICS CO LTD	YLH-1	Min. 1.6 mm thickness, min. V-0, 130°C	IEC 62368-1 UL 796	Tested with appliance UL E251781
Alt. use	Dafeng Arex Electronics Technology Co Ltd	02V0, 03V0 04V0	Min. 1.6 mm thickness, min. V-0, 130°C	IEC 62368-1 UL 796	Tested with appliance UL E186016

IEC 62368-1					
Clause	Requirement + Test			Result - Remark	Verdict
Alt. use	SHENZHEN TONGCHUANGX IN ELECTRONICS CO LTD	TCX	Min. 1.6 mm thickness, min. V- 0, 130°C	IEC 62368-1 UL 796	Tested with appliance UL E250336
Mylar Insulating sheet used between the transformer and secondary D53, D54	TORAY INDUSTRIES INC	Lumirror H10	VTM-2, min. 0.4 mm thickness, 105°C	IEC/EN 62368-1 UL 94 UL 746 A/B/C/D	Tested within appliance UL E86511
Alt. use	SKC CO LTD	SH71S	VTM-2, min. 0.4 mm thickness, 105°C	IEC/EN 62368-1 UL 94 UL 746 A/B/C/D	Tested within appliance UL E74359
Alt. use	FORMEX,DIV OF IL TOOL WORKS INC, FRMRLY FASTEX, DIV OF IL TOOL WORKS INC	FORMEX GK series	V-0, min. 0.4 mm thickness, 115°C	IEC/EN 62368-1 UL 94 UL 746 A/B/C/D	Tested within appliance UL E121855
Alt. use	SABIC INNOVATIVE PLASTICS US L L C	FR60 series FR63 series FR65 series FR7 series FR700 series	V-0, min. 0.4 mm thickness, 130°C	IEC/EN 62368-1 UL 94 UL 746 A/B/C/D	Tested within appliance UL E121562
Alt. use	MIANYANG LONGHUA FILM CO LTD	PP-BK-20 PP-BK-17 PP-BK-18	VTM-0, min. 0.4 mm thickness, 80°C	IEC/EN 62368-1 UL 94 UL 746 A/B/C/D	Tested within appliance UL E254551
Alt. use	CHENGDU KANGLONGXIN PLASTICS CO LTD	KLX PP WT- 10 series	VTM-0, min. 0.4 mm thickness, 110°C	IEC/EN 62368-1 UL 94 UL 746 A/B/C/D	Tested with appliance UL E315185
Alt. use	CHENGDU KANGLONGXIN PLASTICS CO LTD	KLX FRPC- 1860B	VTM-0, min. 0.4 mm thickness, 80°C	IEC/EN 62368-1 UL 94 UL 746 A/B/C/D	Tested with appliance UL E315185
Insulating tape wrapping around the heatsink (Use insulation tape will not use Insulating tube)	3M COMPANY ELECTRICAL MARKETS DIV (EMD)	1350F-1 1350T-1	Min.130°C	IEC/EN 62368-1 UL 510	Tested with appliance UL E17385
Alt. use	BONDTEC PACIFIC CO LTD	370S	Min.130°C	IEC/EN 62368-1 UL 510	Tested with appliance UL E175868

IEC 62368-1					
Clause	Requirement + Test		Result - Remark		Verdict
Alt. use	JINGJIANG YAHUA PRESSURE SENSITIVE GLUE CO LTD	PZ CT	Min.130°C	IEC/EN 62368-1 UL 510	Tested with appliance UL E165111
Alt. use	JINGJIANG JINGYI ADHESIVE PRODUCT CO LTD	JY25-A	Min.130°C	IEC/EN 62368-1 UL 510	Tested with appliance UL E246950
Alt. use	CHANG SHU LIANG YI TAPE INDUSTRY CO LTD	LY-XX	Min.130°C	IEC/EN 62368-1 UL 510	Tested with appliance UL E246820
Insulating tube used on Class I AC inlet pin or heatsink (Heatsink using insulating tube not use insulation tape)	SHENZHEN WOER HEAT- SHRINKABLE MATERIAL CO LTD	RSFR RSFR-H RSFR-HPF	600V, 125°C	IEC/EN 62368-1 UL 224	Tested within appliance UL E203950
Alt. use	QIFURUI ELECTRONICS CO	QFR-h	600V, 125°C	IEC/EN 62368-1 UL 224	Tested within appliance UL E225897
Alt. use	DONGGUAN SALIPT CO LTD	SALIPT S- 901-300 SALIPT S- 901-600	Min. 300V, 125°C	IEC/EN 62368-1 UL 224	Tested within appliance UL E209436
Alt. use	GUANGZHOU KAIHENG ENTERPRISE GROUP	K-2 (+) K-2 (CB)	Min. 300V, 125°C	IEC/EN 62368-1 UL 224	Tested within appliance UL E214175
Alt. use	CHANGYUAN ELECTRONICS (SHENZHEN) CO LTD	CB-HFT	Min. 300V, 125°C	IEC/EN 62368-1 UL 224	Tested within appliance UL E180908
Fuse (FS1, FS2 or F1, F2) (FS2 or F2 is optional) (FS1, FS2 for GT*41133 series, F1, F2 for GT*96900P series, GT*961200P series	Conquer Electronics Co., Ltd.	MST series	T3.15A, 250V	IEC 60127-1 IEC 60127-3 UL 248-1 UL 248-14	VDE 40017118 UL E82636

IEC 62368-1					
Clause	Requirement + Test		Result - Remark		Verdict
Alt. use	SUZHOU WALTER ELECTRONIC CO LTD	2010	T3. 15A, 250Vac, interrupting rating 130A	IEC 60127- 1 IEC 60127-3 UL 248- 1 UL 248- 14	VDE 40018781 E56092
Alt. use	Suzhou Walter Electronic Co. Ltd.	ICP	T3.15A, 250Vac	IEC 60127- 1 IEC-60127-3	VDE 40012824
Alt. use	Dongguan Better Electronics Technology Co., Ltd.	932	T3.15A, 250V	IEC 60127-1 IEC 60127-3 UL 248-1 UL 248-14	VDE 40033369 UL E300003
Alt. use	Zhongshan Lanbao Electrical Appliances Co., Ltd.	RTI-10 Serie(s)	T3.15A, 250V	IEC 60127-1 IEC 60127-3 UL 248-1 UL 248-14	VDE 40017009 UL E213695
Alt. use	Conquer Electronics Co., Ltd	PTU	T3.15A, 250V	IEC 60127- 1 IEC 60127-3 UL 248- 1 UL 248- 14	VDE 40001462 UL E82636
Y capacitor (CY1, CY2) (Optional)	TDK Corporation	CD	Y1, AC250V, 125 °C (For GT*96900P series, GT*961200P series: max. 2200pF,) (For GT*41133 series, max. 1000pF)	IEC/EN 60384-14 UL 60384-14 UL 1414	VDE 40029780 UL E37861
Alt. use	Success Electronics Co., Ltd.	SE	Y1, AC250V, 125 °C (For GT*96900P series, GT*961200P series: max. 2200pF,) (For GT*41133 series, max. 1000pF)	IEC/EN 60384-14 UL 60384-14 UL 1414	VDE 40037211 VDE 40020002 UL E114280

IEC 62368-1					
Clause	Requirement + Test		Result - Remark		Verdict
Alt. use	Success Electronics Co., Ltd.	SB	Y1, AC250V, 125 °C (For GT*96900P series, GT*961200P series: max. 2200pF.) (For GT*41133 series, max. 1000pF)	IEC/EN 60384-14 UL 60384-14 UL 1414	VDE 40037221 VDE 40020001 UL E114280
Alt. use	Murata Mfg. Co., Ltd.	KX	Y1, AC250V, 125 °C (For GT*96900P series, GT*961200P series: max. 2200pF.) (For GT*41133 series, max. 1000pF)	IEC/EN 60384-14 UL 60384-14 UL 1414	VDE 40002831 UL E37921
Alt. use	JYA-NAY Co., Ltd.	JN	Y1, AC250V, 125 °C (For GT*96900P series, GT*961200P series: max. 2200pF.) (For GT*41133 series, max. 1000pF)	IEC/EN 60384-14 UL 60384-14 UL 1414	VDE 40001831 UL E201384
Alt. use	Haohua Electronic Co.	CT 7	Y1, AC250V, 125 °C (For GT*96900P series, GT*961200P series: max. 2200pF.) (For GT*41133 series, max. 1000pF)	IEC/EN 60384-14 UL 60384-14 UL 1414	VDE 40003902 UL E233106
Alt. use	SHANTOU HIGH-NEW TECHNOLOGY DEVELOPMNT ZONE SONGTIAN ENTERPRISE CO LTD	CD	Y1, min. 250VAC, 125°C (For GT*96900P series, GT*961200P series , max. 2200pF.) (For GT*41133 series, max . 1000pF)	IEC/EN 60384-14 UL 60384- 14 UL 1414	VDE 40025754 UL E208107

IEC 62368-1					
Clause	Requirement + Test			Result - Remark	Verdict
X capacitor (CX1) (Optional)	Cheng Tung Industrial Co., Ltd.	CTX	Min. 300VAC, 110 °C, X1 or X2 (For GT*96900P series, GT*961200P series: Max. 0.22µF) (For GT*41133 series: Max. 0.47µF)	IEC 60384-1 UL 60384-14 UL 1414	Tested with appliance UL E193049
Alt. use	Tenta Electric Industrial Co. Ltd.	MEX	Min. 250VAC, 40/100/21/B, X1 or X2 (For GT*96900P series, GT*961200P series: Max. 0.22µF) (For GT*41133 series: Max. 0.47µF)	IEC/EN 60384-14 UL 60384-14 UL 1414	VDE 119119 UL E222911
Alt. use	Ultra Tech Xiphi Enterprise Co. Ltd.	HQX	Min. 250VAC, 40/100/21/C, X1 or X2 (For GT*96900P series, GT*961200P series: Max. 0.22µF) (For GT*41133 series: Max. 0.47µF)	IEC/EN 60384-14 UL 60384-14 UL 1414	VDE 40015608 UL E183780
Alt. use	Sinhua Electronics (Huzhou) Co., Ltd.	MPX	Min. 250VAC, 40/100/21/C, X1 or X2 (For GT*96900P series, GT*961200P series: Max. 0.22µF) (For GT*41133 series: Max. 0.47µF)	IEC/EN 60384-14 UL 60384-14 UL 1414	VDE 40014686 UL E237560

IEC 62368-1					
Clause	Requirement + Test			Result - Remark	Verdict
Alt. use	Dain Electronics Co., Ltd.	MEX, MPX, NPX	Min. 250VAC, 40/100/21/C, X1 or X2 (For GT*96900P series, GT*961200P series: Max. 0.22μF) (For GT*41133 series: Max. 0.47μF)	IEC/EN 60384-14 UL 60384-14 UL 1414	VDE 40018798 UL E147776
Bleeder Resistor (RS1, RS2)	Yageo Corporation	RV series	For GT*41133 series: Max. 2MΩ, Min. 1/4W	IEC/EN 62368-1	UL CB (Cert. No.: DK-108482-UL)
Alt. use	Ralec Electronic Corp	RTV series	For GT*41133 series: Max. 2MΩ, Min. 1/4W	IEC/EN 62368-1	UL CB (Cert. No.: DK-66106-M1-UL)
Alt. use	Guangdong Fenghua Advanced Technology Holding Co.,Ltd.	RVS series	For GT*41133 series: Max. 2MΩ, Min. 1/4W	IEC/EN 62368-1	Nemko CB (NO109708)
Alt. use	Viking Tech Corporation Kaoshiung Branch	HVRC series	For GT*41133 series: Max. 2MΩ, Min. 1/4W	IEC/EN 62368-1	UL CB (Cert. No.: DK-121748-UL)
Alt. use	TZAI YUAN ENTERPRISE CO LTD	HSMD OR SMD	For GT*41133 series: Max. 2MΩ, Min. 1/4W	IEC/EN 62368-1	UL CB (Cert. No.: DK-29431-M1-UL)
Alt. use	WALSIN TECHNOLOGY CORP	WF12N, WF20N, WF25N, WF08N,WF06N	For GT*41133 series: Max. 2MΩ, Min. 1/4W	IEC/EN 62368-1	UL CB (Cert. No.: DK-119162-UL)
Alt. use	Yageo Corporation	AH series	For GT*41133 series: Max. 2MΩ, Min. 1/4W	IEC/EN 62368-1	DK-110207-UL
Alt. use	PDC	FVS03,FVS05,FVS06,FVS20,TF25V,TF06V,TF08V,TF12V,TF20V,FVS25	For GT*41133 series: Max. 2MΩ, Min. 1/4W	IEC/EN 62368-1	DK-101615-UL

IEC 62368-1					
Clause	Requirement + Test			Result - Remark	Verdict
Bleeder resistance	Interchangeable	Interchangeable	For GT*96900P series and For GT*961200P series: R1, R2: Max. 2MΩ; R1A, R2A: Max. 4.7MΩ	IEC/EN 62368-1	Tested with appliance
- Description:	Interchangeability based on specified rating.				
Optocoupler (U2)	Everlight Electronics Co., Ltd.	EL817	Dti=0.5mm Int. , dcr=6.0mm EXT.dcr=7.7mm, thermal cycling test, 110°C insulation: AC 4800V min. Thermal cycling test passed. Reinforced insulation	IEC/EN 60747-5-2	VDE 132249
Alt. use	COSMO Electronics Corporation	K1010 / KP1010	Dti=0.6mm Int. , dcr=4.0mm EXT.dcr=5.0mm, thermal cycling test, 115°C insulation: AC 4800V min. Thermal cycling test passed. Reinforced insulation	IEC/EN 60747-5-2	VDE 101347
Alt. use	Lite-On Technology Corporation	LTV-817	Dti=0.8mm Int. , EXT.dcr=7.8mm, thermal cycling test, 100°C insulation: AC 4800V min. Thermal cycling test passed. Reinforced insulation	IEC/EN 60747-5-2	VDE 40015248

IEC 62368-1					
Clause	Requirement + Test			Result - Remark	Verdict
Alt. use	Bright Led Electronics Corp.	BPC-817 A/B/C/D/L BPC-817 M BPC-817 S	Dti=0.4mm EXT.dcr=7.0mm, thermal cycling test, 110°C insulation: AC 4800V min. Thermal cycling test passed. Reinforced insulation	IEC/EN 60747-5-2	VDE 40007240
Varistor MOV1 (Optional)	Xiamen Set Electronics Co., Ltd.	TFV8S471K	Max. Continuous voltage: Min. 300Vac(rms), Min. 105°C, The coating is Min. V-0	IEC 61051-1, IEC 61051-2, IEC 61051-2-2, IEC 62368-1:2018 Annex G.8.1 and G.8.2	TUV-RH (J 50554061)
Alt. use	Xiamen SET Electronics Co., Ltd.	TFV10S471K	Max. Continuous voltage: Min. 300Vac(rms), Min. 105°C, The coating is Min. V-0	IEC 61051-1, IEC 61051-2, IEC 61051-2-2, IEC 62368-1:2018 Annex G.8.1 and G.8.2	TUV-RH (J 50554091)
Alt. use	SHANTOU HIGH-NEW TECHNOLOGY DEVELOPMNT ZONE SONGTIAN ENTERPRISE CO LTD	10D621K	Max. Continuous voltage: Min. 385Vac(rms), Min. 125°C, The coating is Min. V-0	IEC/EN 61051-1 IEC/EN 61051-2 UL1449	VDE 40023049
Alt. use	Guangdong Huiwan Electronics Technology Co.Ltd.	V-621K-10 DEH	Max. Continuous voltage: Min. 385Vac(rms), Min. 125°C, The coating is Min. V-0	IEC/EN 61051-1 IEC/EN 61051-2 UL1449	VDE 40043880

IEC 62368-1					
Clause	Requirement + Test		Result - Remark		Verdict
Alt. use	Thinking Electronic Industrial Co., Ltd.	TVR10621	Max. Continuous voltage: Min. 385Vac(rms), Min. 125°C, The coating is Min. V-0	IEC/EN 61051-1 IEC/EN 61051-2 UL1449	VDE005944
Earthing wire for Class I model	KUNSHAN NEW ZHICHENG ELECTRONICS TECHNOLOGIES CO LTD	1015,1007, 1185	Min. 20 AWG, Min. 300V, Min. 80°C	IEC/EN 62368-1	Tested with appliance UL E237831
Alt. use	ZHUANG SHAN CHUAN ELECTRICAL PRODUCTS (KUNSHAN) CO LTD	1015,1007, 1185	Min. 20 AWG, Min. 300V, Min. 80°C	IEC/EN 62368-1	Tested with appliance UL E333601
Alt. use	Suzhou Jiahuishu Electronic Co Ltd	1015,1007, 1185	Min. 20 AWG, Min. 300V, Min. 80°C	IEC/EN 62368-1	Tested with appliance UL E353532
Alt. use	GlobTek, Inc.	1015, 1007 1185	Min. 20AWG, Min. 300V, Min. 80°C	IEC/EN 62368- 1	Tested with appliance UL E464257
Alt. use	Interchangeable	Interchangeable	Min. 20 AWG, Min. 300V, Min. 80°C	IEC/EN 62368- 1	UL
Output cord	KUNSHAN NEW ZHICHENG ELECTRONICS TECHNOLOGIES CO LTD	1185, 2464, 2468, 1015	Min. 20AWG, min. 300Vac, min. 80°C	IEC/EN 62368-1 UL 758	Tested with appliance UL E237831
Alt. use	Suzhou Jiahuishu Electronic Co Ltd	1185, 2464, 2468, 1015	Min. 20AWG, min. 300Vac, min. 80°C	IEC/EN 62368- 1 UL 758	Tested with appliance UL E353532
Alt. use	ZHUANG SHAN CHUAN ELECTRICAL PRODUCTS (KUNSHAN) CO LTD	1185,2464,2468, 1015	Min. 20AWG, min. 300Vac, min. 80°C	IEC/EN 62368- 1 UL 758	Tested with appliance UL E333601

IEC 62368-1					
Clause	Requirement + Test			Result - Remark	Verdict
Alt. use	ZHUANG SHAN CHUAN ELECTRICAL PRODUCTS (KUNSHAN) CO LTD	SPT-1, SPT-2	Min. 20AWG, min. 300Vac, min. 80°C	IEC/EN 62368- 1 UL 758	Tested with appliance UL E333536
Alt. use	GLOBTEK INC	1185,2464, 2468,1015	Min. 20AWG, min. 300Vac, min. 80°C	IEC/EN 62368- 1 UL 758	Tested with appliance UL E464257
Alt. use	GLOBTEK INC	SPT-1, SPT- 2	Min. 20AWG, min. 300Vac, min. 80°C	IEC/EN 62368- 1 UL 758	Tested with appliance UL E245414
Alt. use	Interchangeable	Interchangea ble	Min. 24AWG, min. 300Vac, min. 80°C	IEC/EN 62368-1 UL 758	Tested with appliance UL approved
- Description:	Interchangeability based on specified rating.				
Line filter (LF1) (Optional)	GlobTek/HAOPU WEI/HEJIA/BOA M/ENG	LF001	130°C	IEC/EN 62368-1	Tested with appliance
Line filter (LF2) (Optional)	GlobTek/HAOPU WEI/HEJIA/BOA M/ENG	LF002 (For model:GT* 41133 series) LF026 (model:GT* 96900 P series, LF025 (For model GT*961200 P series)	130°C	IEC/EN 62368-1	Tested with appliance
Line filter (L1) (Optional)	GlobTek/HAOPU WEI/HEJIA/BOA M/ENG	LF003 (For model: GT*41133 series, GT*96900P series), LF027 (For model: GT*961200 P series)	130°C	IEC/EN 62368-1	Tested with appliance

IEC 62368-1					
Clause	Requirement + Test			Result - Remark	Verdict
PFC Chock (L2) (Optional)	GlobTek/HAOPU WEI/HEJIA/BOA M/ENG	LF004(For model: GT*41133 series), LF028 (model: GT*96900 P series), LF029 (model : GT*961200 P series)	130°C	IEC/EN 62368-1	Tested with appliance
Transformer (T1)	GlobTek / ENG / BOAM / HAOPUWEI	See attachment for details	Class B, with critical component listed below	IEC/EN 62368-1	Tested with appliance
- Magnet wire	PACIFIC ELECTRIC WIRE & CABLE (SHENZHEN) CO LTD	UEWN/U (UL E201757)	MW28-C, 130°C	IEC/EN 62368-1	Tested with appliance
Alt. use	PACIFIC ELECTRIC WIRE & CABLE (SHENZHEN) CO LTD	UEWS/U (UL E201757)	MW75-C, 130°C	IEC/EN 62368-1	Tested with appliance
Alt. use	JUNG SHING WIRE CO LTD	UEW-4 (UL E174837)	MW75C, 130°C	IEC/EN 62368-1	Tested with appliance
Alt. use	JUNG SHING WIRE CO LTD	UEY-2 (UL E174837)	MW28-C, 130°C	IEC/EN 62368-1	Tested with appliance
Alt. use	JIANGSU HONGLIU MAGNET WIRE TECHNOLOGY CO LTD	2UEW/130 (UL E335065)	MW75-C, 130°C	IEC/EN 62368-1	Tested with appliance
Alt. use	SHENZHEN DAYANG INDUSTRY CO LTD	2UEW/130 (UL E158909)	MW75-C, 130°C	IEC/EN 62368-1	Tested with appliance
Alt. use	WUXI JUFENG COMPOUND LINE CO LTD	2UEWB (UL E206882)	MW75#, 130°C	IEC/EN 62368-1	Tested with appliance
Alt. use	JIANGSU DARTONG M & E CO LTD	UEW (UL E237377)	MW 75-C, 130°C	IEC/EN 62368-1	Tested with appliance

IEC 62368-1					
Clause	Requirement + Test			Result - Remark	Verdict
Alt. use	SHANDONG SAINT ELECTRIC CO LTD	UEW/130 (UL E194410)	MW75#, 130°C	IEC/EN 62368-1	Tested with appliance
Alt. use	ZHEJIANG LANGLI ELECTRIC EQUIPMENTS CO LTD	UEW (UL E222214)	MW 79#, 130°C	IEC/EN 62368-1	Tested with appliance
-Triple-insulated wire (Secondary)	Great Leoflon Industrial Co., Ltd.	TRW (B) Serie(s)	Class B, reinforced insulation	IEC 62368-1 UL 2353 UL 60601-1	VDE 136581 UL E211989
- Alt. use	COSMOLINK CO. Ltd.	TIW-M Serie(s)	Class B, reinforced insulation	IEC 62368-1 UL 2353 UL 60601-1	VDE 138053 UL E213764
- Alt. use	Furukawa Electric Co., Ltd. Electronics & Automotive Systems Company Global Business Development Division	TEX-E	Class B, reinforced insulation	IEC 62368-1 UL 2353 UL 60601-1	VDE 006735 UL E206440
- Alt. use	TOTOKU ELECTRIC CO LTD	TIW-2	Reinforced insulation, rated 130° C (Class B)	IEC 62368-1 UL 2353 UL 60601-1	VDE 40051990 UL 166483
- Alt. use	HOI LUEN ELECTRICAL MFR CO LTD	THL-F-xx, THL-F-SB-xx	Reinforced insulation, Class B	IEC 62368- 1 UL 2353 UL 60601- 1	UL E257525 VDE 40020365
-Bobbin	CHANG CHUN PLASTICS CO LTD	T375J, T375HF	V-0, 150°C, thickness 0.45 mm min.	IEC 62368-1 UL 94 UL 746 A/B/C/D	Tested with appliance UL E59481
- Alt. use	CHANG CHUN PLASTICS CO LTD	4130	V-0, 140°C, thickness 0.74 mm min.	IEC 62368-1 UL 94 UL 746 A/B/C/D	Tested with appliance UL E59481
- Alt. use	SUMITOMO BAKELITE CO LTD	PM-9820	V-0, 150°C, thickness 0.45 mm min.	IEC 62368-1 UL 94 UL 746 A/B/C/D	Tested with appliance UL E41429
- Alt. use	HITACHI CHEMICAL CO LTD	CP-J-8800	V-0, 150°C, thickness 0.45 mm min.	IEC 62368-1 UL 94 UL 746 A/B/C/D	Tested with appliance UL E42956
-Insulating tape	3M COMPANY ELECTRICAL MARKETS DIV (EMD)	1350F-1 1350T-1 44	Min.130°C	IEC 62368-1 UL 510	Tested with appliance UL E17385

IEC 62368-1					
Clause	Requirement + Test			Result - Remark	Verdict
- Alt. use	BONDTEC PACIFIC CO LTD	370S	Min.130°C	IEC 62368-1 UL 510	Tested with appliance UL E175868
- Alt. use	JINGJIANG YAHUA PRESSURE SENSITIVE GLUE CO LTD	PZ CT WF	Min.130°C	IEC 62368-1 UL 510	Tested with appliance UL E165111
- Alt. use	JINGJIANG JINGYI ADHESIVE PRODUCT CO LTD	JY25-A	Min.130°C	IEC 62368-1 UL 510	Tested with appliance UL E246950
- Alt. use	CHANG SHU LIANG YI TAPE INDUSTRY CO LTD	LY-XX	Min.130°C	IEC 62368-1 UL 510	Tested with appliance UL E246820
-PTFE tubing	GREAT HOLDING INDUSTRIAL CO LTD	TFT / TFS	Min. 300V, 200°C	IEC 62368-1	Tested with appliance UL E156256
-Alt. use	SHENZHEN WOER HEAT- SHRINKABLE MATERIAL CO LTD	WF	600V, 200°C	IEC 62368-1	Tested with appliance UL E203950
-Alt. use	CHANGYUAN ELECTRONICS (SHENZHEN) CO LTD	CB-TT-T / CB-TT-S	Min. 300V, 200°C	IEC 62368-1	Tested with appliance UL E180908
Supplementary information:					
<p>1) Provided evidence ensures the agreed level of compliance. See OD-CB2039.</p> <p>2) This must be a certification mark showing compliance with an applicable IEC standard and National or Regional Differences. For all transformers under all manufacturers. "Interchangeable" components comply with IECCE OD file: od-g-2060_ed 1.1</p>					

IEC 62368-1			
Clause	Requirement + Test	Result - Remark	Verdict

Attachment for transformer as below:

Product Model	Voltage range	Transformer model
GT*41133 series	12-16V	TF013
	16.1-24V	TF014
	24.1-35V	TF015
	35.1-48V	TF012
GT*96900P series and GT*961200P series	12-13.4V	TF047
	13.5-14.9V	TF075
	15-16.9V	TF048
	17-18.9V	TF076
	19-21.3V	TF072
	21.4-23.9V	TF077
	24-27.4V	TF049
	27.5-31.4V	TF078
	31.5-36V	TF073
	36.1-41.9V	TF079
	42-48V	TF050
	48.1-54V	TF074

Appendix No.1: Photos of product

GT*41133 series External view

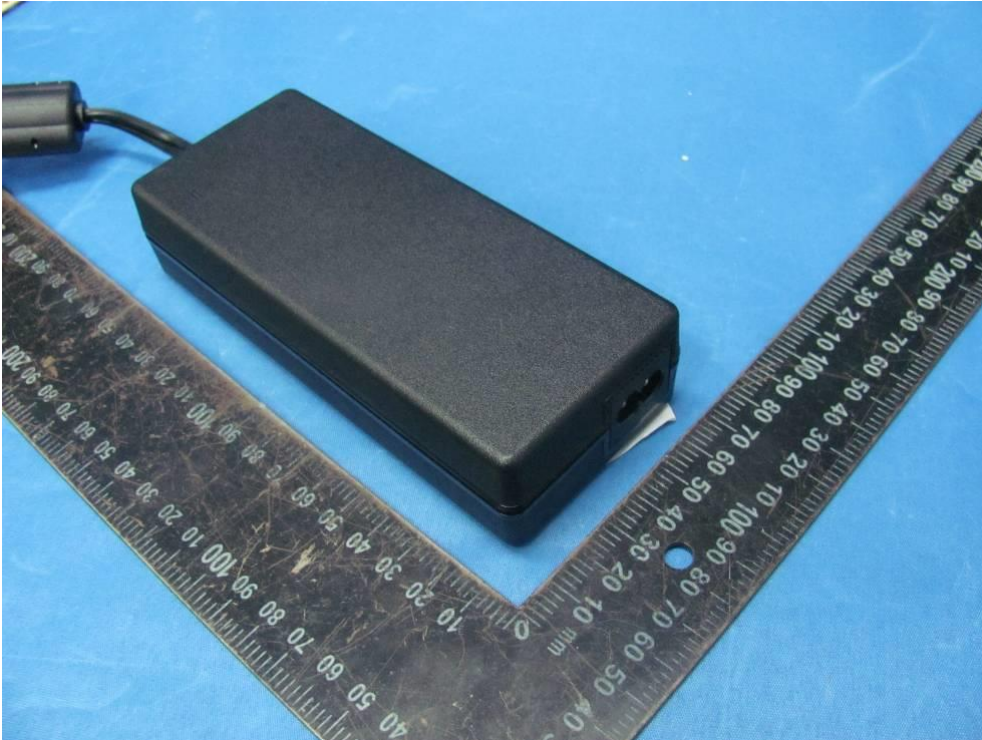

GT*41133 series External view



GT*41133 series Component side view of PCB for power adapter model (Top heatsink removed)

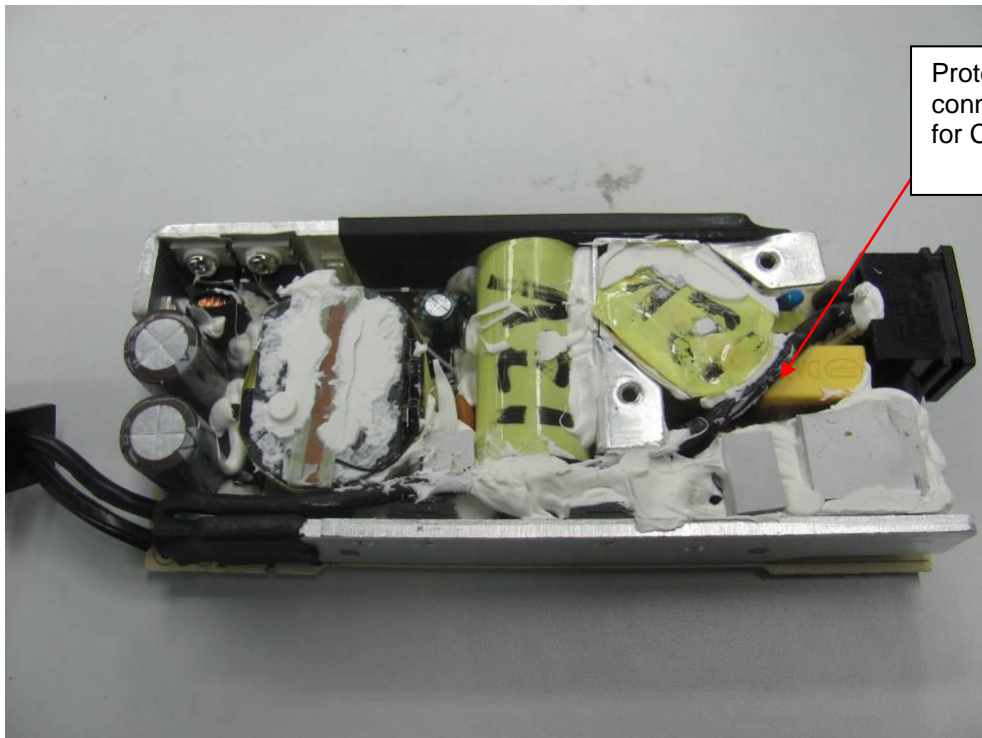

GT*41133 series Internal view – soldering side view of PCB

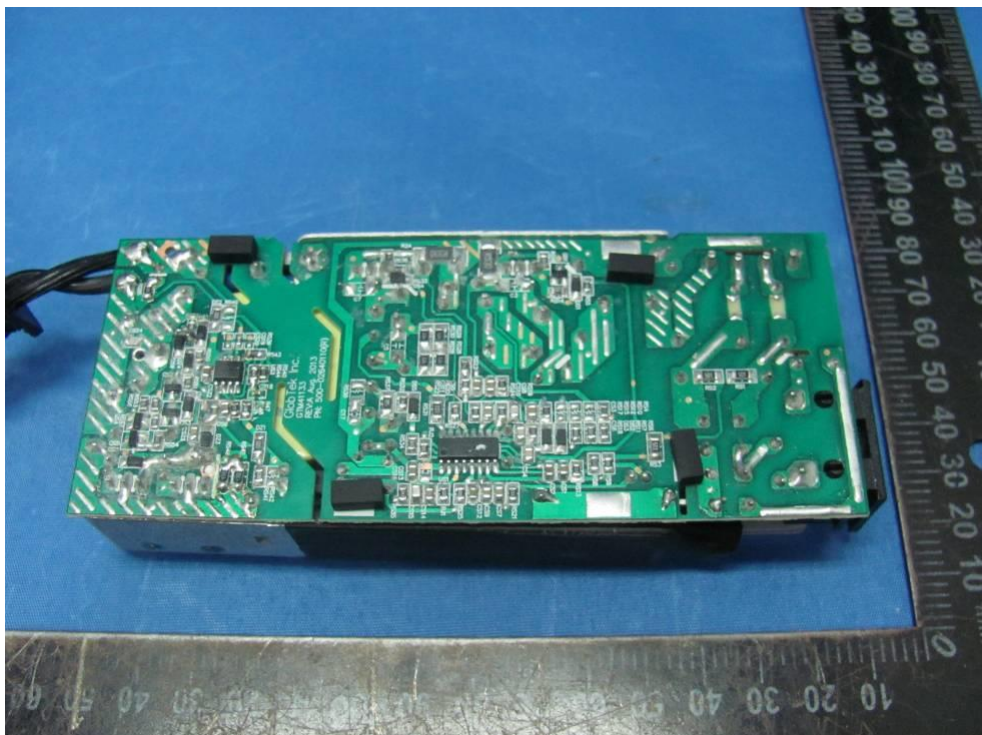

GT*41133 series Component side view of PCB for open frame model

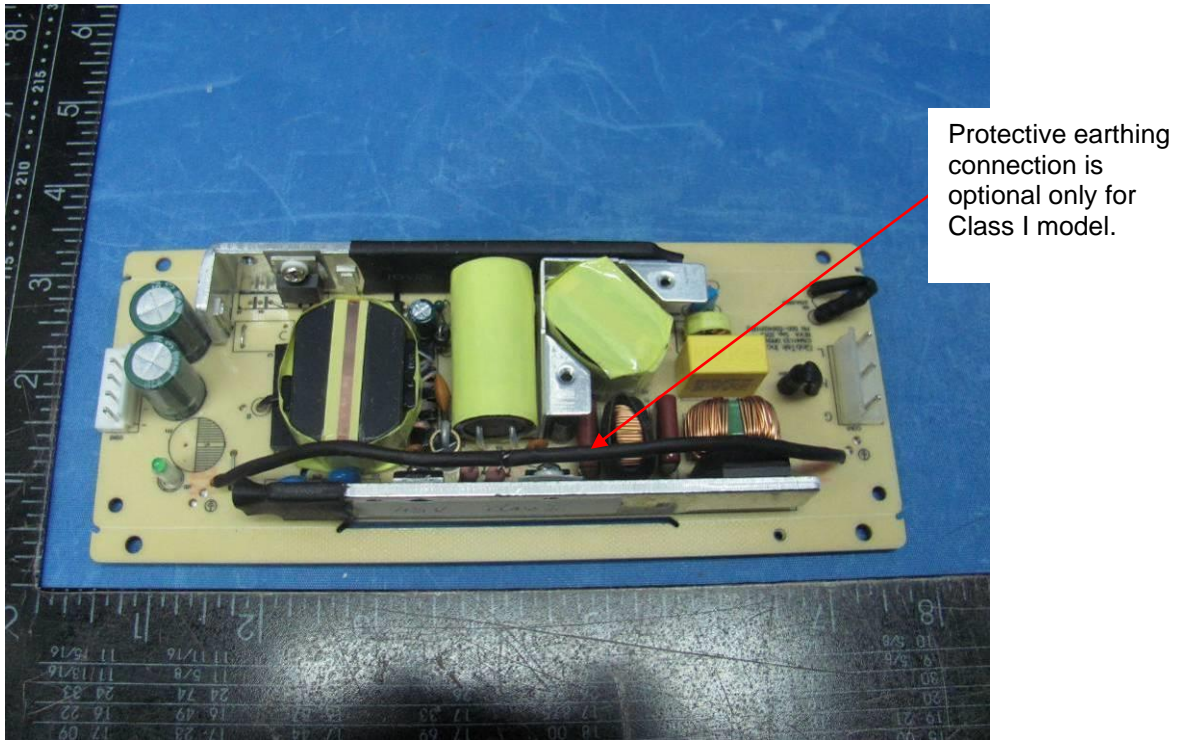

GT*41133 series Soldering side view of PCB for open frame model

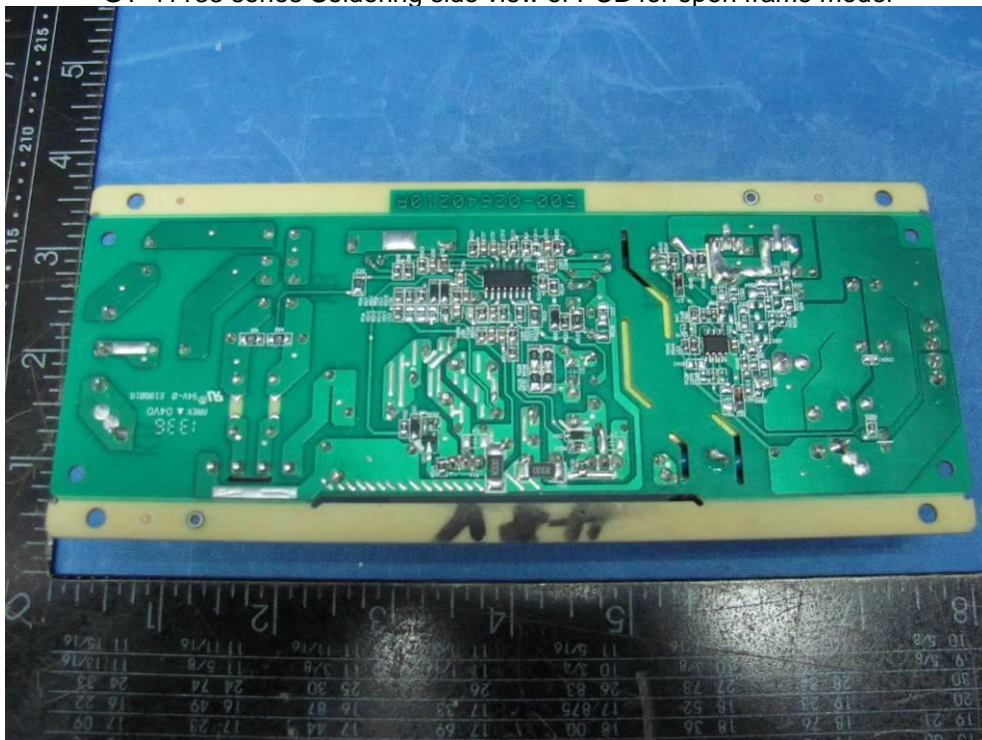

GT*41133 series Internal view of EUT for power adapter model with heatsink

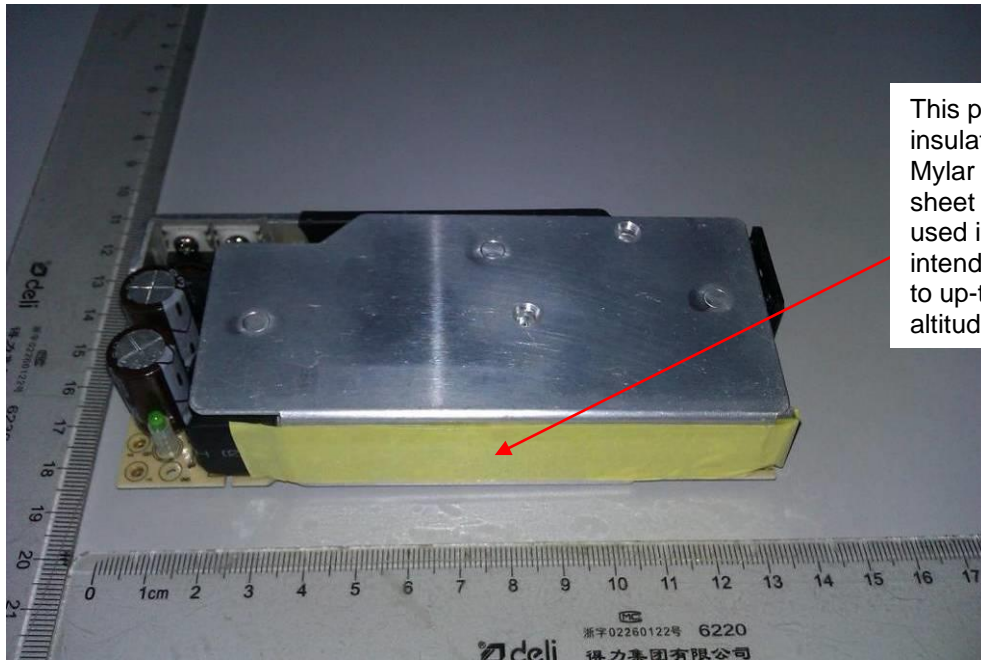

GT*41133 series View of insulation protection on heatsink (2 layers of insulating tape or 2 layers of heat-shrinkable tube)

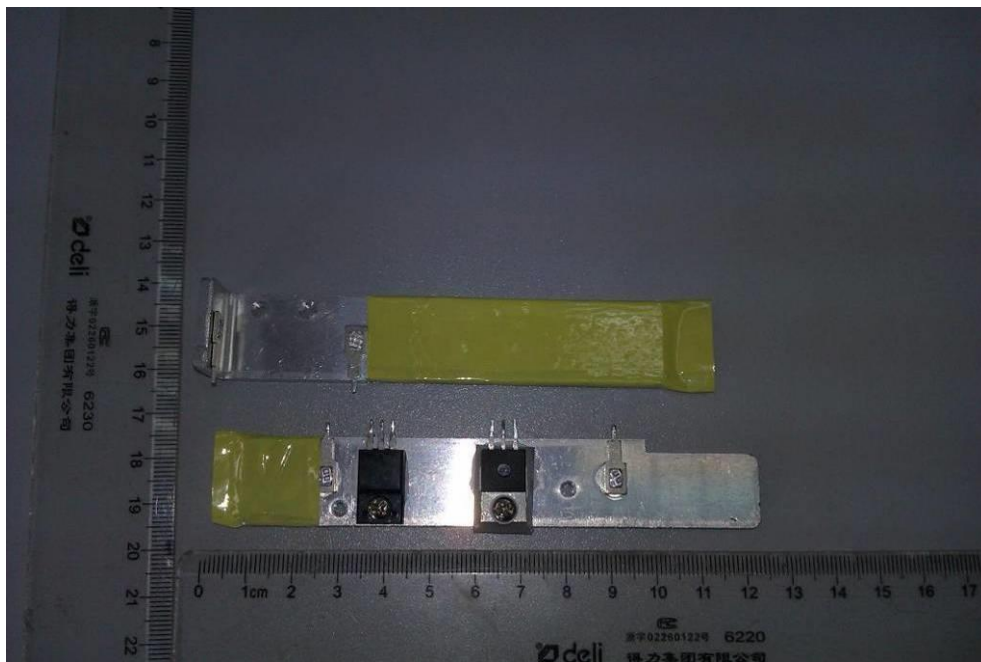

GT*41133 series External view of mains transformer



GT*41133 series Primary winding view of mains transformer

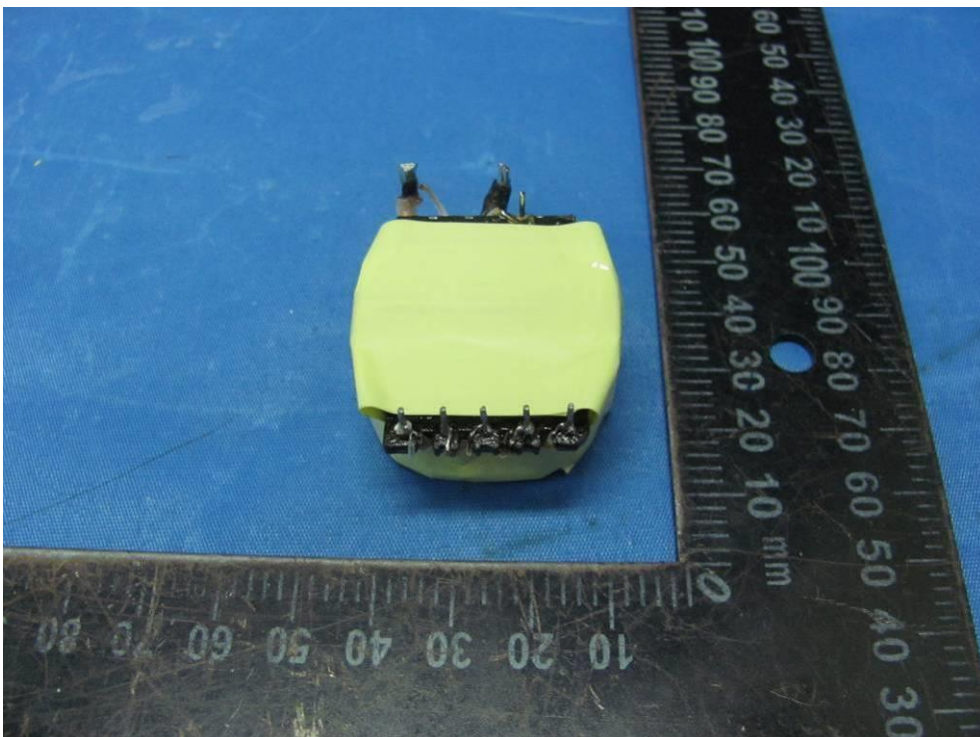

GT*41133 series External view of mains transformer (shield copper foil)



GT*41133 series Bottom view of mains transformer (The ferrite core is wrapped around 2 layers of insulating tape.)

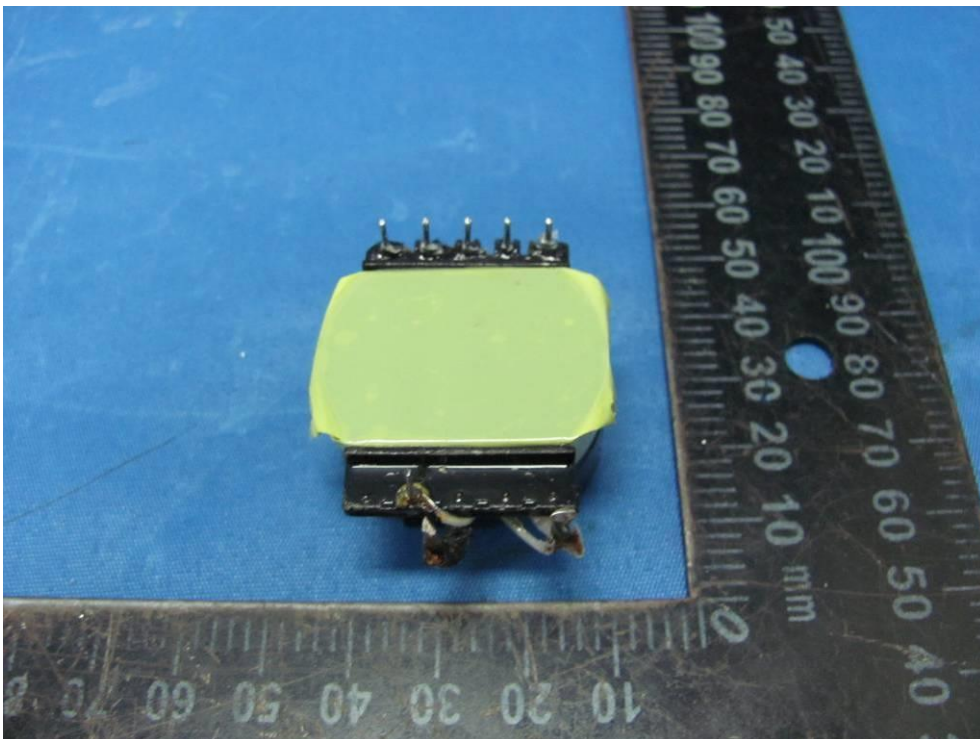

GT*41133 series Primary winding view of mains transformer



GT*41133 series Secondary winding view of mains transformer (TIW)



GT*96900P series, GT*961200P series External view



GT*96900P series, GT*961200P series External view



GT*96900P series, GT*961200P series External view



GT*96900P series, GT*961200P series External view



GT*96900P series, GT*961200P series Internal view (Class II)

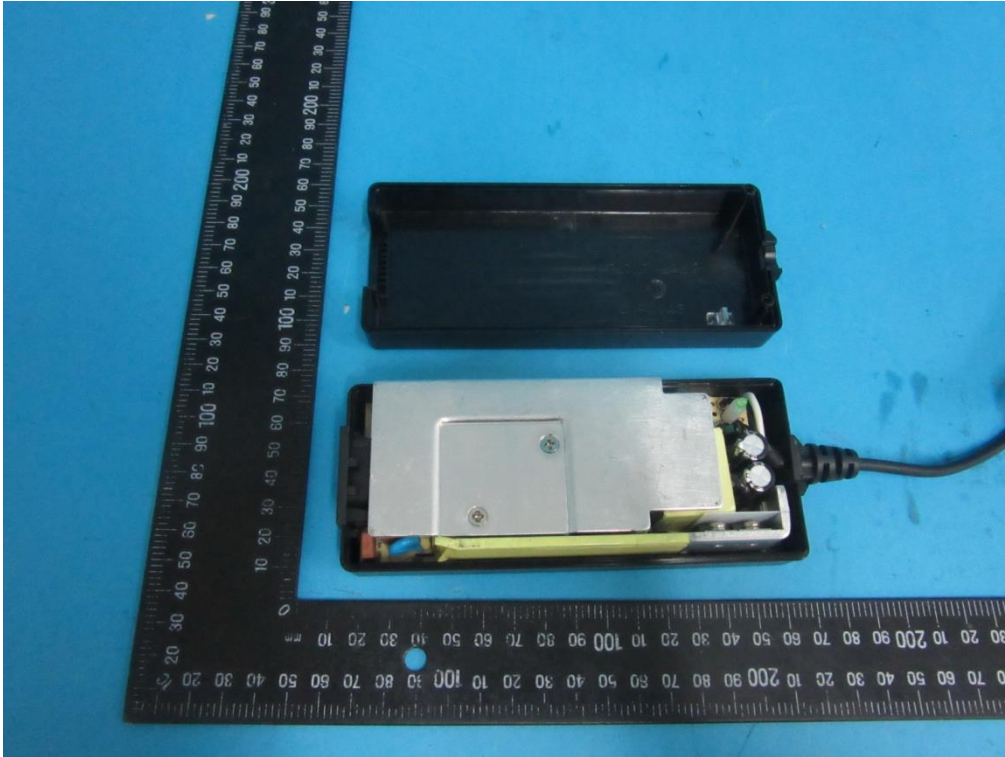

GT*96900P series, GT*961200P series Internal view (Class II)

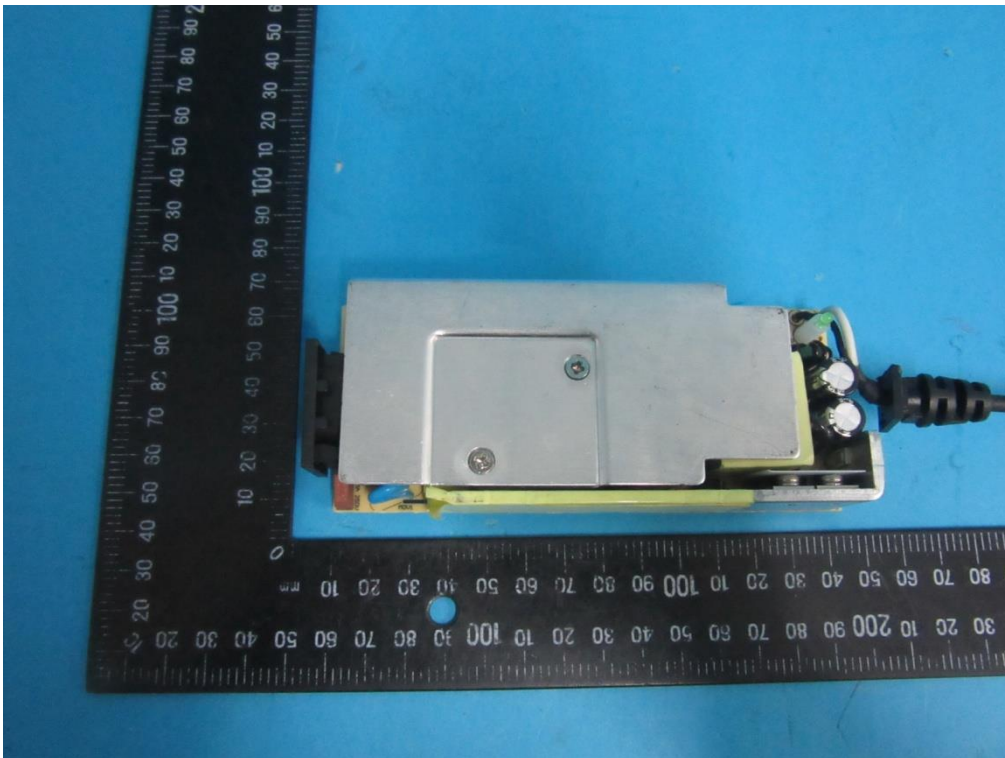

GT*96900P series, GT*961200P series Internal view (Class II)

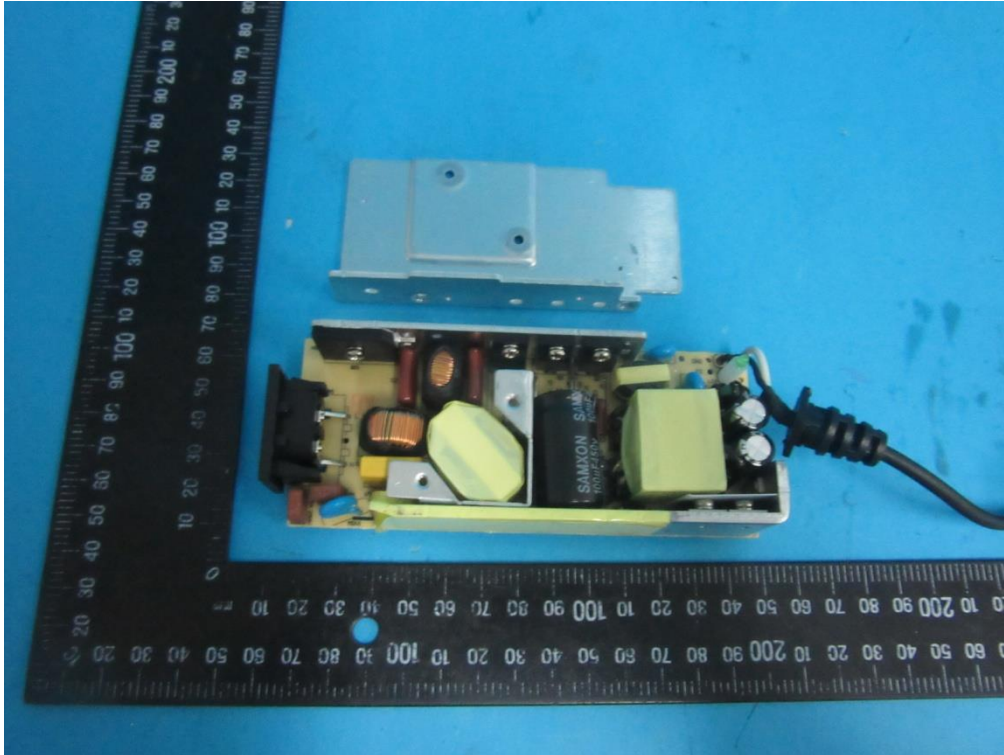

GT*96900P series, GT*961200P series Internal view (Class I)

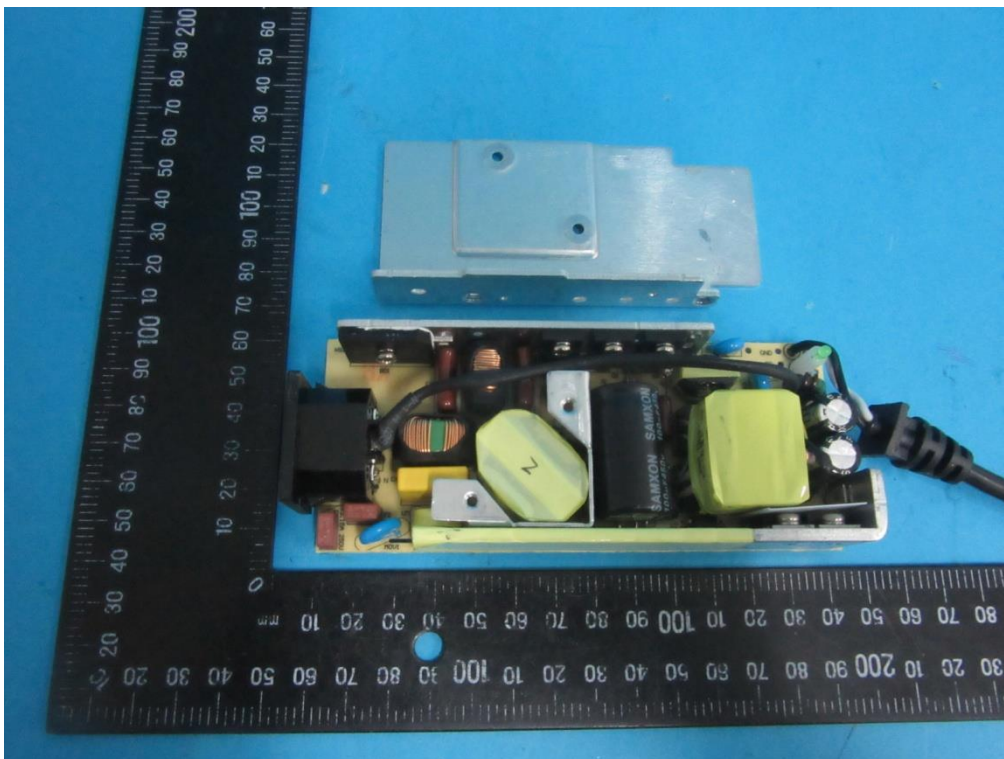

GT*96900P series, GT*961200P series Internal view (Class II)

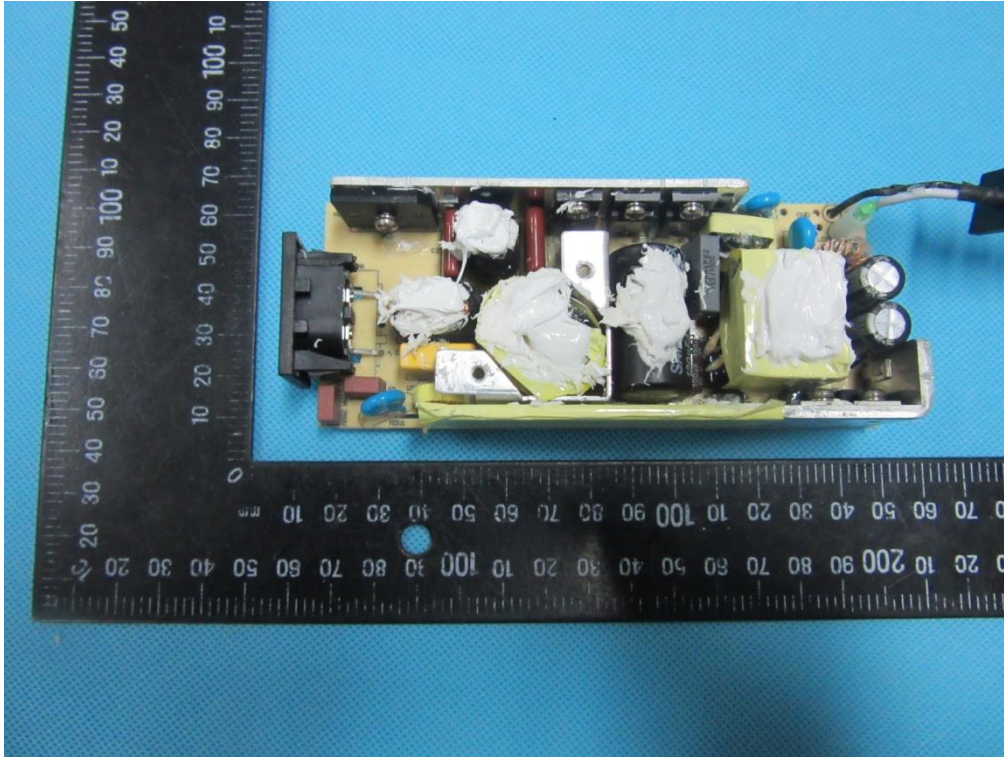

GT*96900P series, GT*961200P series PCB

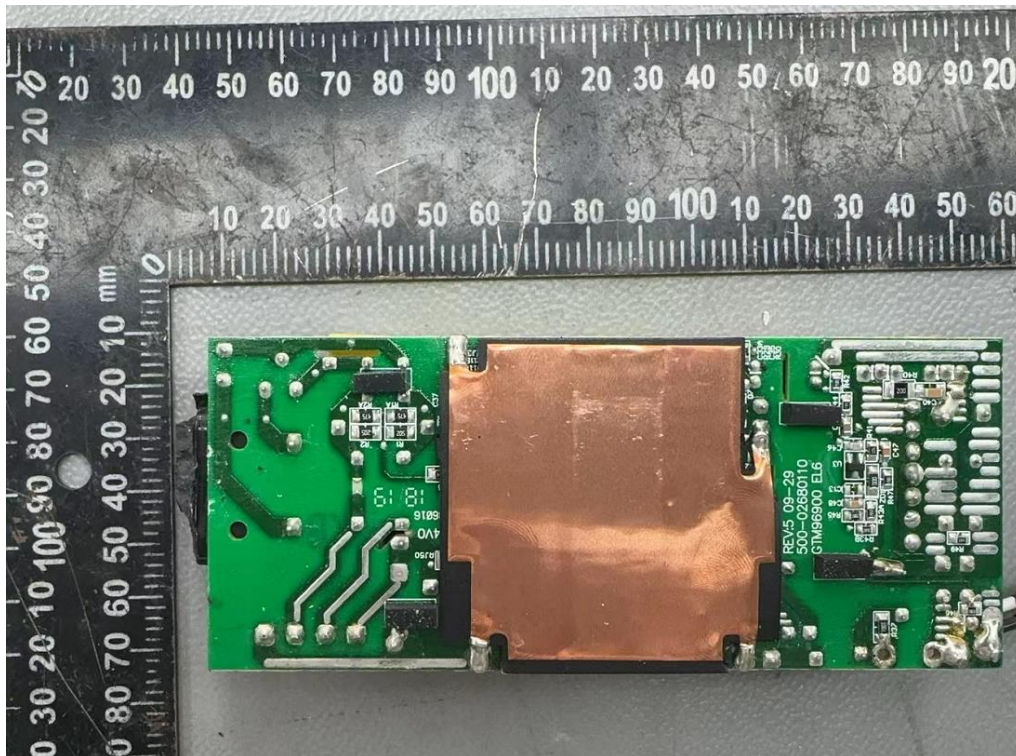

GT*96900P series, GT*961200P series PCB

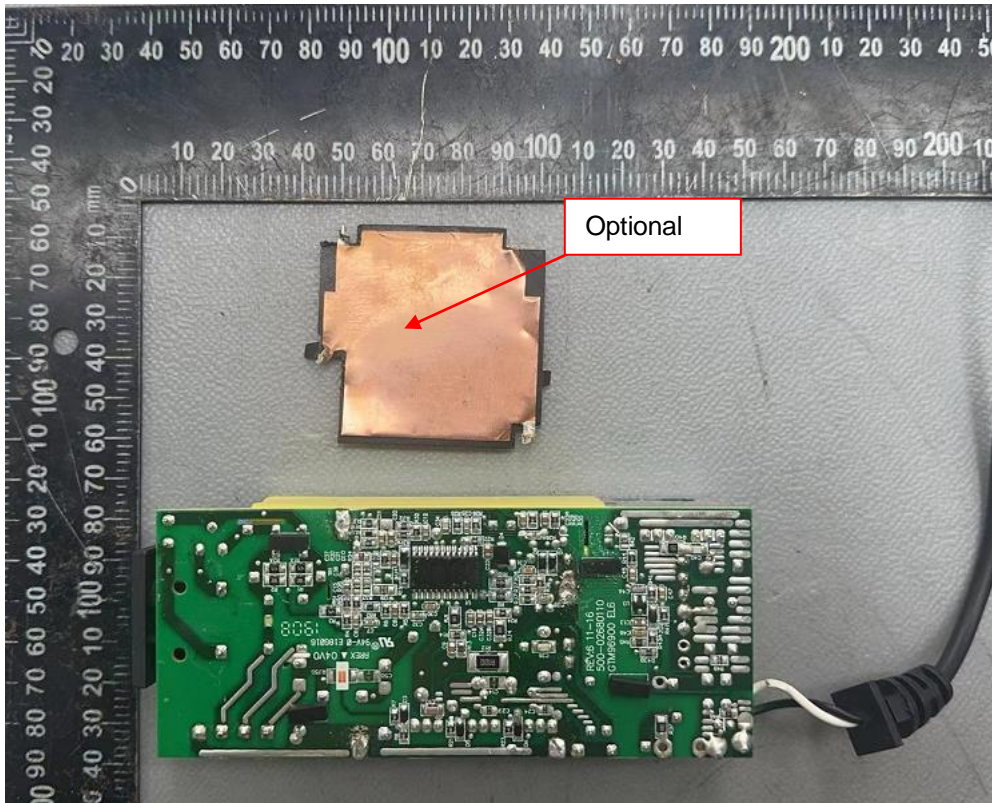

GT*96900P series, GT*961200P series Transformer

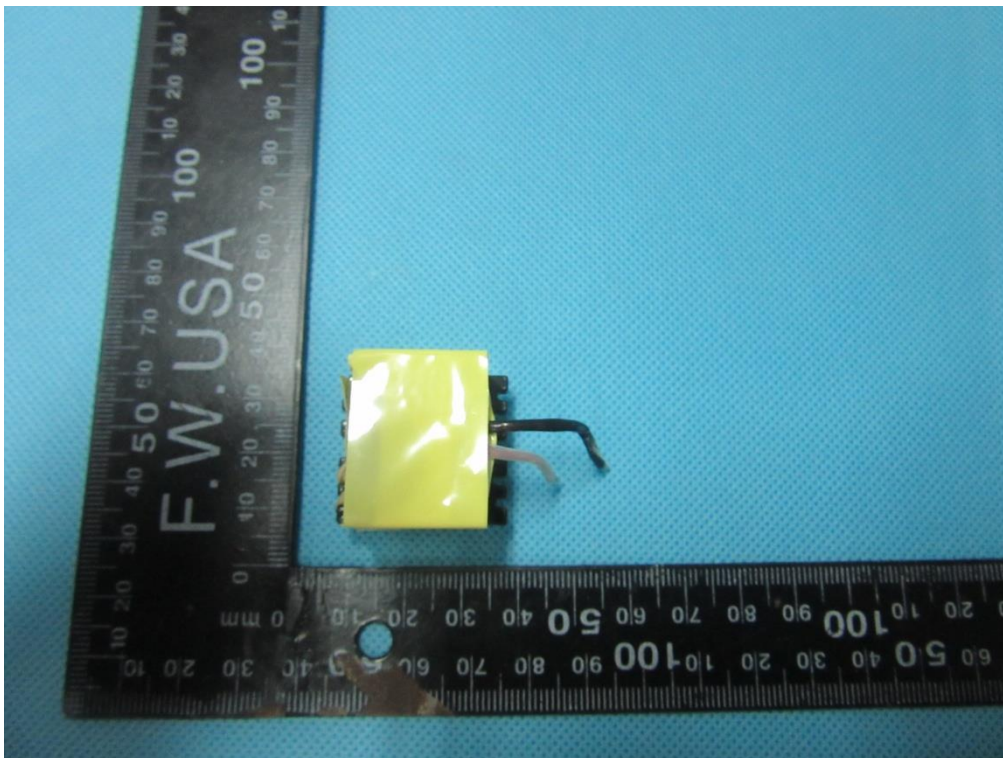

GT*96900P series, GT*961200P series Transformer

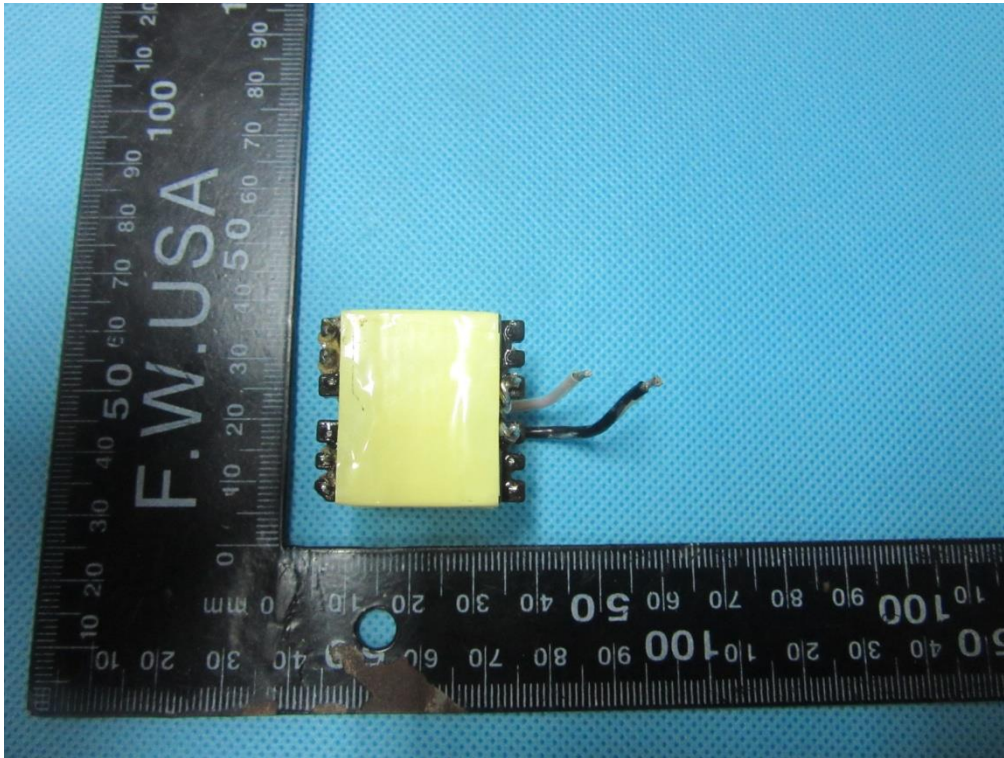

GT*96900P series, GT*961200P series Transformer

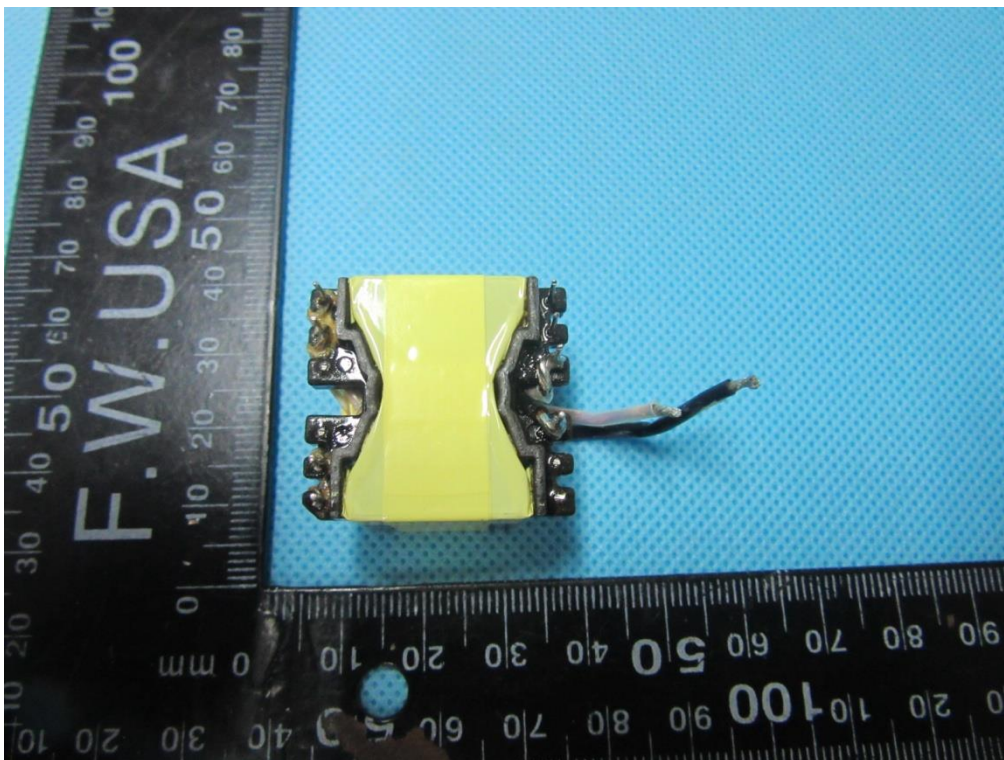

GT*96900P series, GT*961200P series Transformer

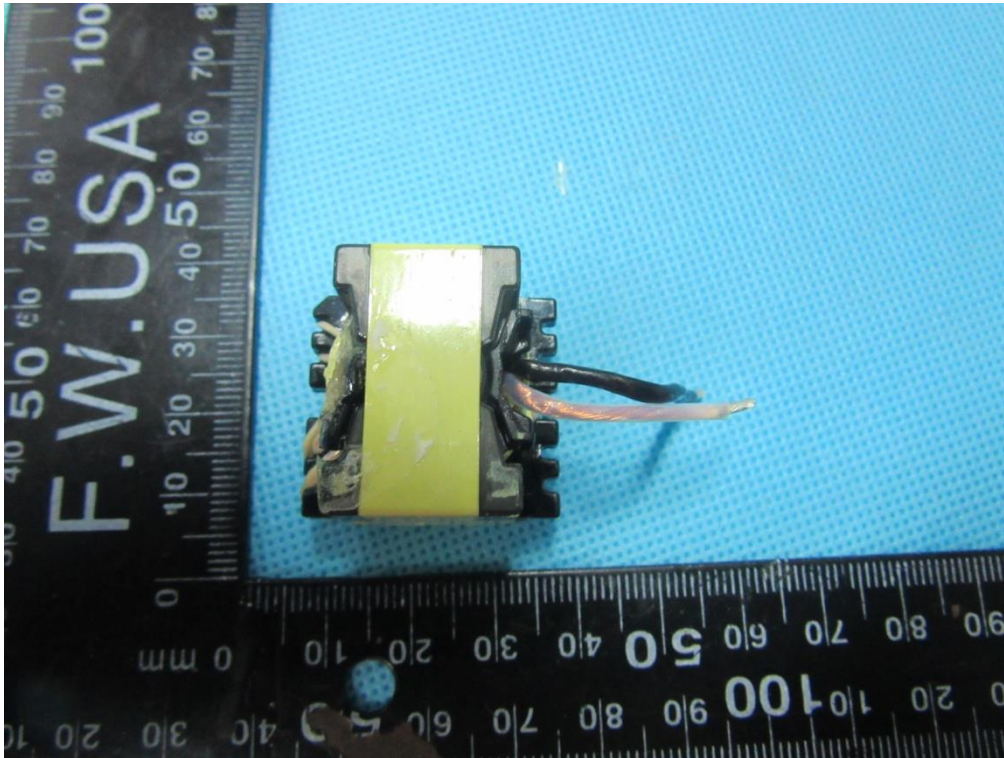

GT*96900P series, GT*961200P series Transformer

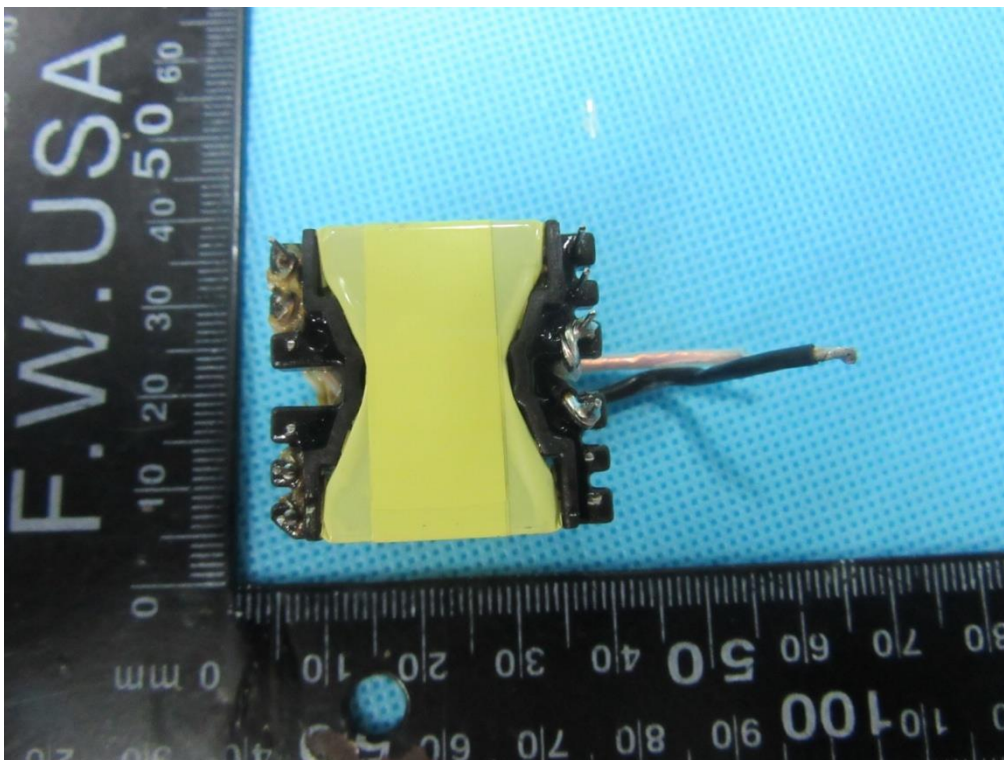

GT*96900P series, GT*961200P series Transformer



GT*96900P series, GT*961200P series Transformer

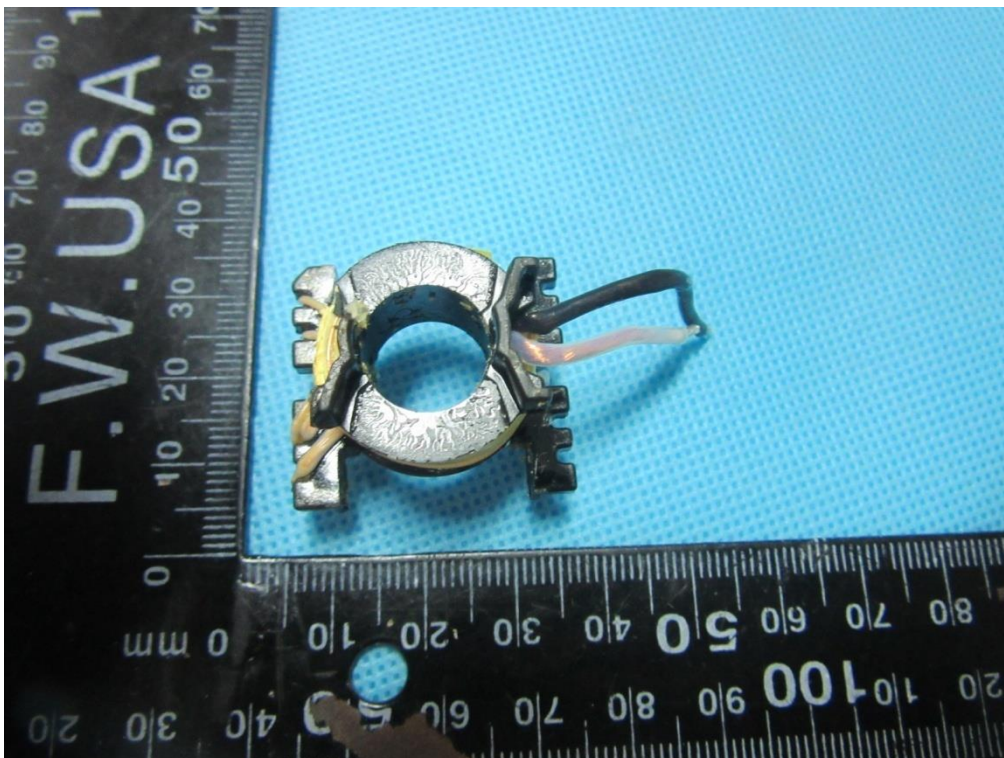

GT*96900P series, GT*961200P series Transformer

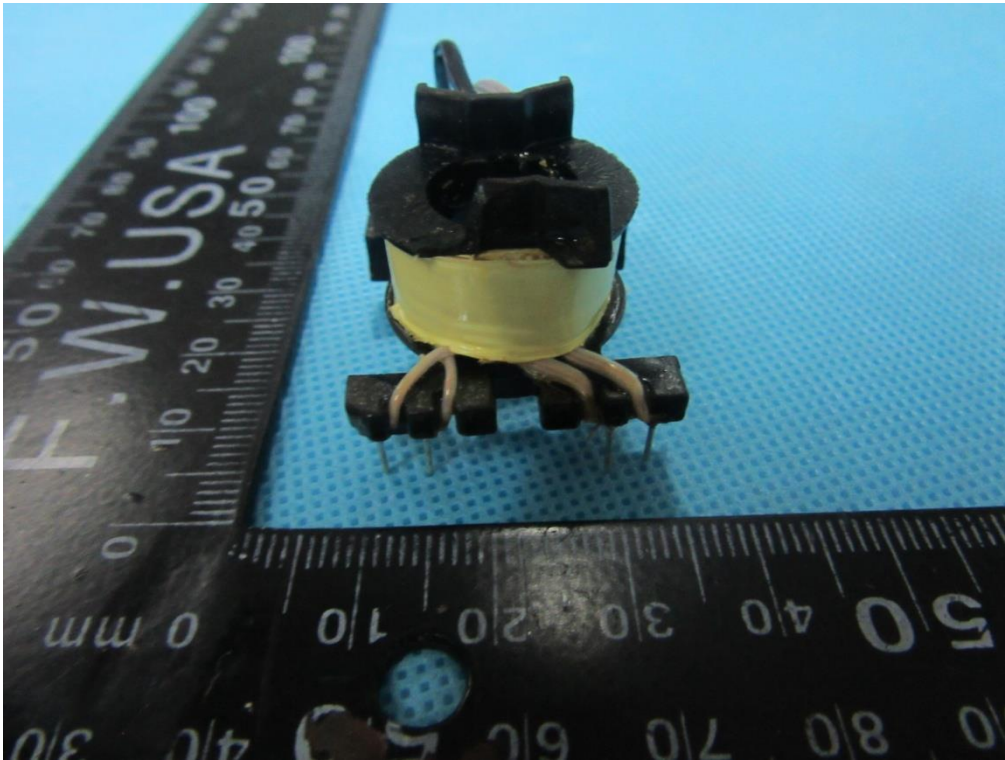

GT*96900P series, GT*961200P series Transformer

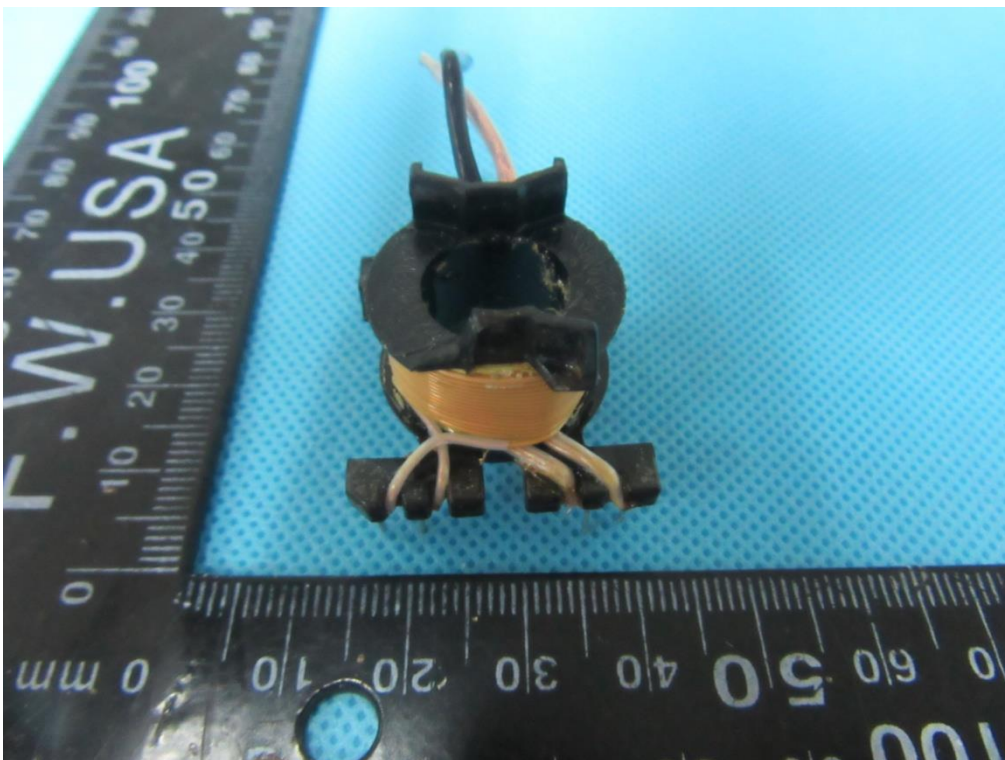

GT*96900P series, GT*961200P series Transformer

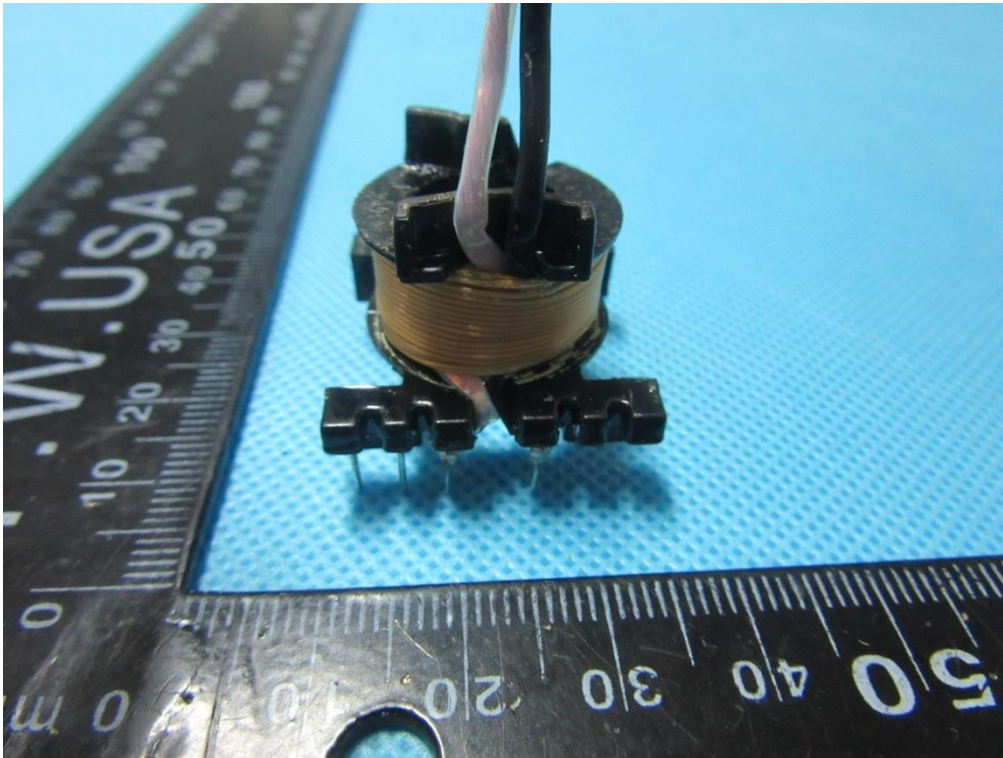

GT*96900P series, GT*961200P series Transformer

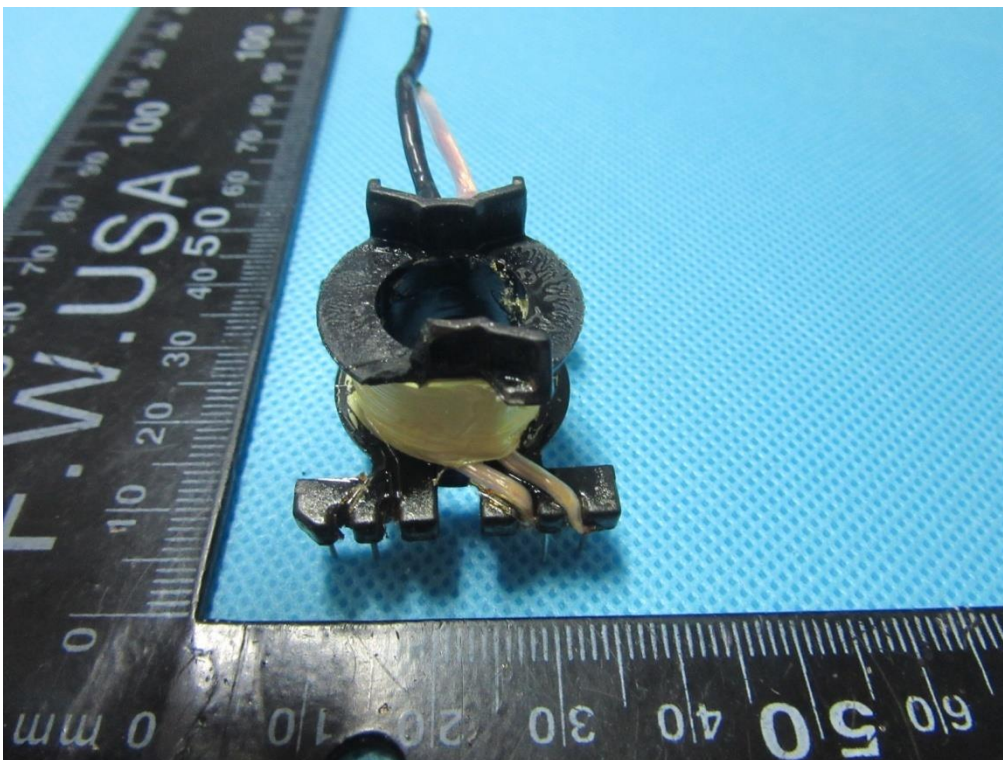

GT*96900P series, GT*961200P series Transformer

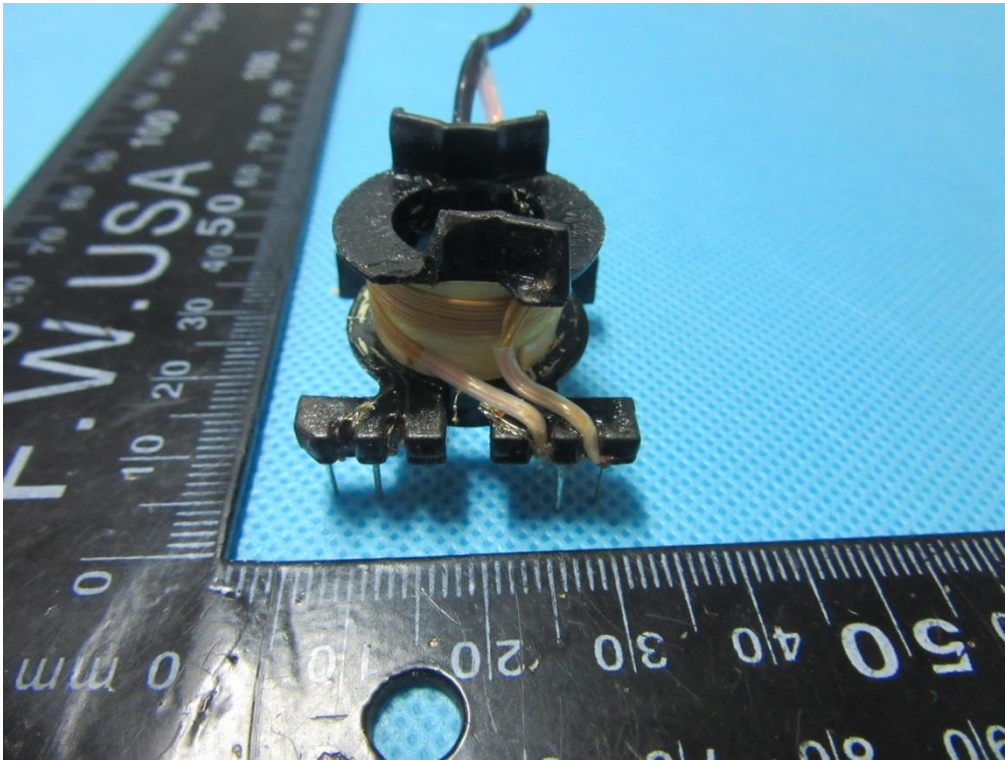

GT*96900P series, GT*961200P series Transformer

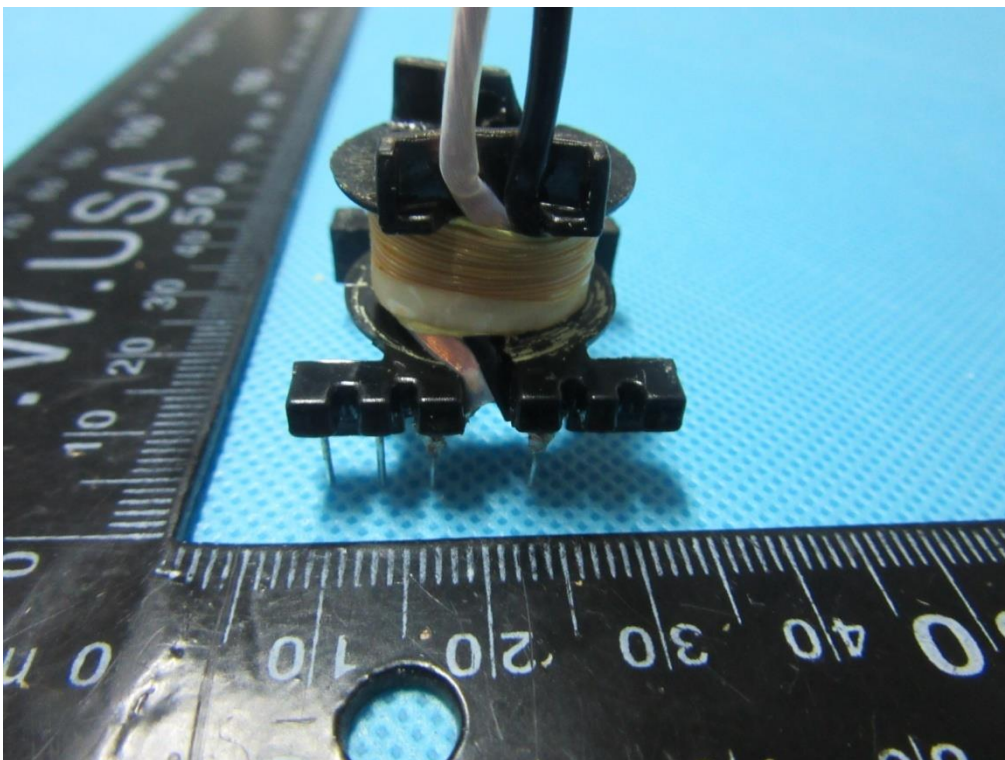

GT*96900P series, GT*961200P series Transformer

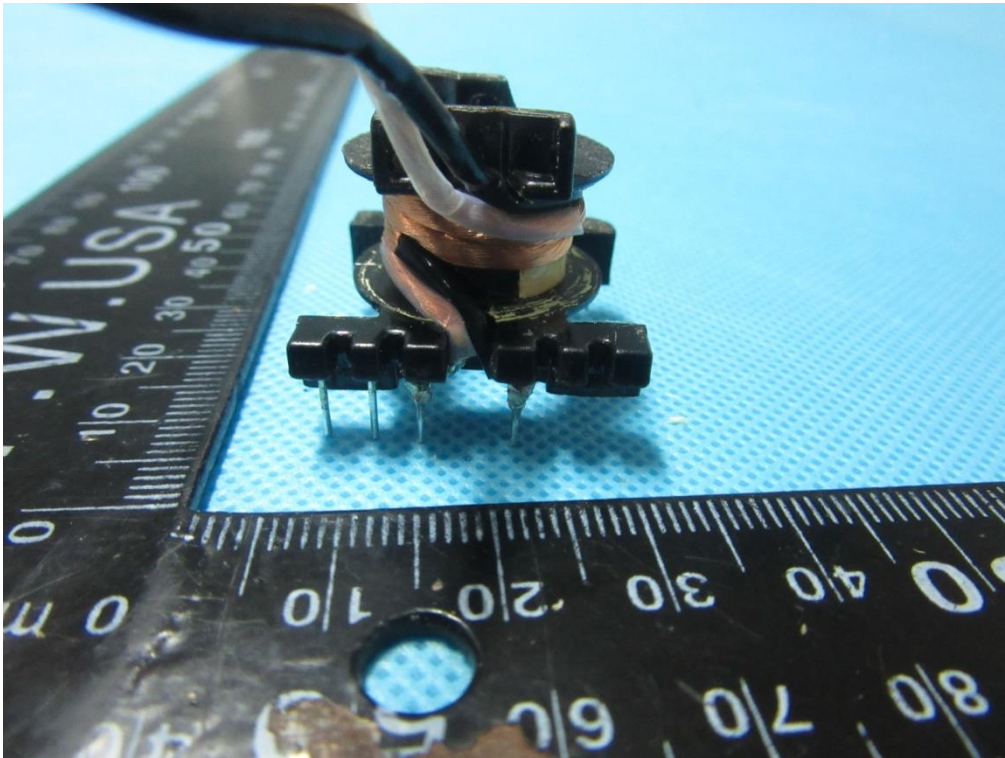

GT*96900P series, GT*961200P series Transformer

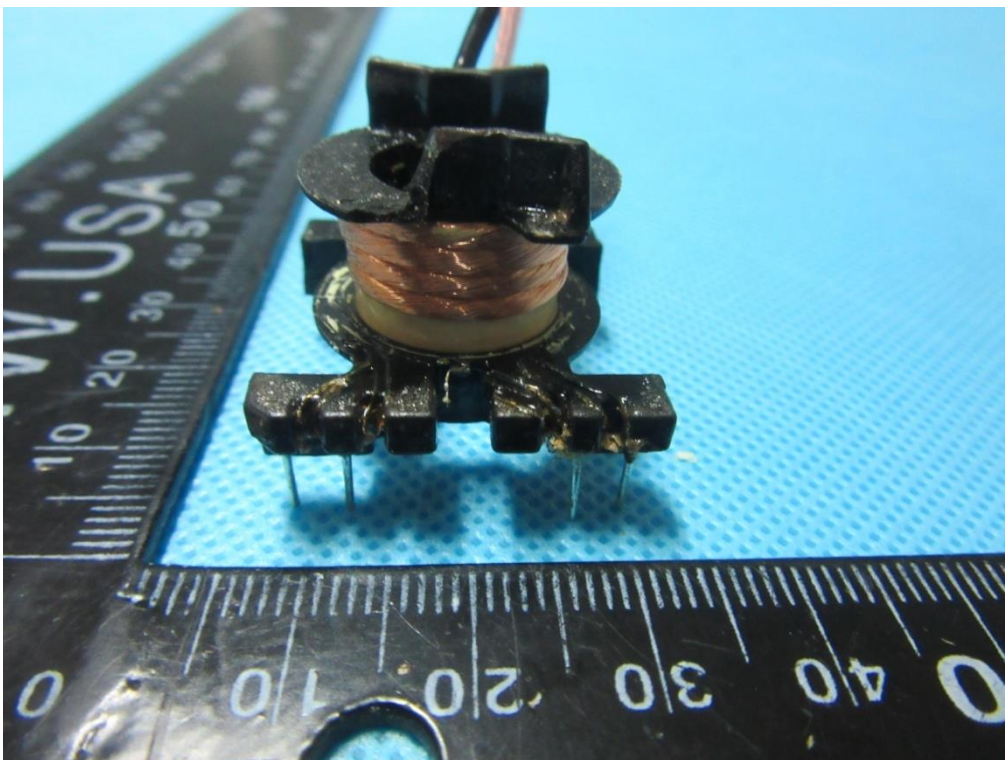

GT*96900P series, GT*961200P series Transformer



IEC62368_1E - ATTACHMENT			
Clause	Requirement + Test	Result - Remark	Verdict

Appendix No.2: Group and national differences for the CENELEC countries

<p align="center">ATTACHMENT TO TEST REPORT IEC 62368-1 EUROPEAN GROUP DIFFERENCES AND NATIONAL DIFFERENCES (AUDIO/VIDEO, INFORMATION AND COMMUNICATION TECHNOLOGY EQUIPMENT - PART 1: SAFETY REQUIREMENTS)</p>		
Differences according to : EN IEC 62368-1:2020+A11:2020		
Attachment Form No. : EU_GD_IEC62368_1E		
Attachment Originator : UL(Demko)		
Master Attachment : 2021-02-04		
Copyright © 2021 IEC System for Conformity Testing and Certification of Electrical Equipment (IECEE), Geneva, Switzerland. All rights reserved.		
	CENELEC COMMON MODIFICATIONS (EN)	P
	<p>Clause numbers in the cells that are shaded light grey are clause references in EN IEC 62368-1:2020+A11:2020. All other clause numbers in that column, except for those in the paragraph below, refers to IEC 62368-1:2018.</p> <p>Clauses, subclauses, notes, tables, figures and annexes which are additional to those in IEC 62368-1:2018 are prefixed "Z".</p>	P
	<p>Add the following annexes:</p> <p>Annex ZA (normative) Normative references to international publications with their corresponding European publications</p> <p>Annex ZB (normative) Special national conditions</p> <p>Annex ZC (informative) A-deviations</p> <p>Annex ZD (informative) IEC and CENELEC code designations for flexible cords</p>	P
1	Modification to Clause 3 .	
3.3.19	<p>Sound exposure</p> <p><i>Replace 3.3.19 of IEC 62368-1 with the following definitions:</i></p>	N/A

IEC62368_1E - ATTACHMENT			
Clause	Requirement + Test	Result - Remark	Verdict
3.3.19.1	<p>momentary exposure level, MEL</p> <p>metric for estimating 1 s sound exposure level from the HD 483-1 S2 test signal applied to both channels, based on EN 50332-1:2013, 4.2.</p> <p>Note 1 to entry: MEL is measured as A-weighted levels in dB.</p> <p>Note 2 to entry: See B.3 of EN 50332-3:2017 for additional information.</p>		N/A
3.3.19.3	<p>sound exposure, E</p> <p>A-weighted sound pressure (p) squared and integrated over a stated period of time, T</p> <p>Note 1 to entry: The SI unit is Pa² s.</p> $E = \int_0^T p(t)^2 dt$		N/A
3.3.19.4	<p>sound exposure level, SEL</p> <p>logarithmic measure of sound exposure relative to a reference value, E_0, typically the 1 kHz threshold of hearing in humans.</p> <p>Note 1 to entry: SEL is measured as A-weighted levels in dB.</p> $SEL = 10 \lg\left(\frac{E}{E_0}\right) \text{ dB}$ <p>Note 2 to entry: See B.4 of EN 50332-3:2017 for additional information.</p>		N/A

IEC62368_1E - ATTACHMENT			
Clause	Requirement + Test	Result - Remark	Verdict
3.3.19.5	<p>digital signal level relative to full scale, dBFS</p> <p>levels reported in dBFS are always r.m.s. Full scale level, 0 dBFS, is the level of a dc-free 997-Hz sine wave whose undithered positive peak value is positive digital full scale, leaving the code corresponding to negative digital full scale unused</p> <p>Note 1 to entry: It is invalid to use dBFS for non-r.m.s. levels. Because the definition of full scale is based on a sine wave, the level of signals with a crest factor lower than that of a sine wave may exceed 0 dBFS. In particular, square wave signals may reach +3,01 dBFS.</p>		N/A
2	Modification to Clause 10		
10.6	<p>Safeguards against acoustic energy sources</p> <p>Replace 10.6 of IEC 62368-1 with the following:</p>		N/A
10.6.1.1	<p>Introduction</p> <p>Safeguard requirements for protection against long-term exposure to excessive sound pressure levels from personal music players closely coupled to the ear are specified below. Requirements for earphones and headphones intended for use with personal music players are also covered.</p> <p>A personal music player is a portable equipment intended for use by an ordinary person, that:</p> <ul style="list-style-type: none"> – is designed to allow the user to listen to audio or audiovisual content / material; and – uses a listening device, such as headphones or earphones that can be worn in or on or around the ears; and – has a player that can be body worn (of a size suitable to be carried in a clothing pocket) and is intended for the user to walk around with while in continuous use (for example, on a street, in a subway, at an airport, etc.). <p>EXAMPLES Portable CD players, MP3 audio players, mobile phones with MP3 type features, PDAs or similar equipment.</p> <p>Personal music players shall comply with the requirements of either 10.6.2 or 10.6.3.</p>		N/A

IEC62368_1E - ATTACHMENT			
Clause	Requirement + Test	Result - Remark	Verdict
	<p>NOTE 1 Protection against acoustic energy sources from telecom applications is referenced to ITU-T P.360.</p> <p>NOTE 2 It is the intention of the Committee to allow the alternative methods for now, but to only use the dose measurement method as given in 10.6.5 in future. Therefore, manufacturers are encouraged to implement 10.6.5 as soon as possible.</p> <p>Listening devices sold separately shall comply with the requirements of 10.6.6.</p> <p>These requirements are valid for music or video mode only.</p> <p>The requirements do not apply to:</p> <ul style="list-style-type: none"> – professional equipment; <p>NOTE 3 Professional equipment is equipment sold through special sales channels. All products sold through normal electronics stores are considered not to be professional equipment.</p> <ul style="list-style-type: none"> – hearing aid equipment and other devices for assistive listening; – the following type of analogue personal music players: <ul style="list-style-type: none"> • long distance radio receiver (for example, a multiband radio receiver or world band radio receiver, an AM radio receiver), and • cassette player/recorder; <p>NOTE 4 This exemption has been allowed because this technology is falling out of use and it is expected that within a few years it will no longer exist. This exemption will not be extended to other technologies.</p> <ul style="list-style-type: none"> – a player while connected to an external amplifier that does not allow the user to walk around while in use. <p>For equipment that is clearly designed or intended primarily for use by children, the limits of the relevant toy standards may apply.</p>		

IEC62368_1E - ATTACHMENT			
Clause	Requirement + Test	Result - Remark	Verdict
	The relevant requirements are given in EN 71-1:2011, 4.20 and the related tests methods and measurement distances apply.		
10.6.1.2	<p>Non-ionizing radiation from radio frequencies in the range 0 to 300 GHz</p> <p>The amount of non-ionizing radiation is regulated by European Council Recommendation 1999/519/EC of 12 July 1999 on the limitation of exposure of the general public to electromagnetic fields (0 Hz to 300 GHz).</p> <p>For intentional radiators, ICNIRP guidelines should be taken into account for Limiting Exposure to Time-Varying Electric, Magnetic, and Electromagnetic Fields (up to 300 GHz). For hand-held and body-mounted devices, attention is drawn to EN 50360 and EN 50566.</p>		N/A
10.6.2	Classification of devices without the capacity to estimate sound dose		N/A
10.6.2.1	<p>General</p> <p>This standard is transitioning from short-term based (30 s) requirements to long-term based (40 hour) requirements. These clauses remain in effect only for devices that do not comply with sound dose estimation as stipulated in EN 50332-3.</p> <p>For classifying the acoustic output $L_{Aeq,T}$, measurements are based on the A-weighted equivalent sound pressure level over a 30 s period.</p> <p>For music where the average sound pressure (long term $L_{Aeq,T}$) measured over the duration of the song is lower than the average produced by the programme simulation noise, measurements may be done over the duration of the complete song. In this case, T becomes the duration of the song.</p> <p>NOTE Classical music, acoustic music and broadcast typically has an average sound pressure (long term $L_{Aeq,T}$) which is much lower than the average programme simulation noise. Therefore, if the player is capable to analyse the content and compare it with the programme simulation noise, the warning does not need to be given as long as the average sound pressure of the song does not exceed the required limit.</p> <p>For example, if the player is set with the programme simulation noise to 85 dB, but the average music level of the song is only 65 dB, there is no need to give a warning or ask an acknowledgement as long as the average sound level of the song is not above the basic limit of 85 dB.</p>		N/A

IEC62368_1E - ATTACHMENT			
Clause	Requirement + Test	Result - Remark	Verdict
10.6.2.2	<p>RS1 limits (to be superseded, see 10.6.3.2)</p> <p>RS1 is a class 1 acoustic energy source that does not exceed the following:</p> <ul style="list-style-type: none"> – for equipment provided as a package (player with its listening device), and with a proprietary connector between the player and its listening device, or where the combination of player and listening device is known by other means such as setting or automatic detection, the $L_{Aeq,T}$ acoustic output shall be ≤ 85 dB when playing the fixed “programme simulation noise” described in EN 50332-1. – for equipment provided with a standardized connector (for example, a 3,5 phone jack) that allows connection to a listening device for general use, the unweighted r.m.s. output voltage shall be ≤ 27 mV (analogue interface) or -25 dBFS (digital interface) when playing the fixed “programme simulation noise” described in EN 50332-1. – The RS1 limits will be updated for all devices as per 10.6.3.2. 		N/A
10.6.2.3	<p>RS2 limits (to be superseded, see 10.6.3.3)</p> <p>RS2 is a class 2 acoustic energy source that does not exceed the following:</p> <ul style="list-style-type: none"> – for equipment provided as a package (player with its listening device), and with a proprietary connector between the player and its listening device, or when the combination of player and listening device is known by other means such as setting or automatic 130 detection, the $L_{Aeq,T}$ acoustic output shall be ≤ 100 dB(A) when playing the fixed “programme simulation noise” as described in EN 50332-1. – for equipment provided with a standardized connector (for example, a 3,5 phone jack) that allows connection to a listening device for general use, the unweighted r.m.s. output voltage shall be ≤ 150 mV (analogue interface) or -10 dBFS (digital interface) when playing the fixed “programme simulation noise” as described in EN 50332-1. 		N/A
10.6.2.4	<p>RS3 limits</p> <p>RS3 is a class 3 acoustic energy source that exceeds RS2 limits.</p>		N/A
10.6.3	Classification of devices (new)		N/A

IEC62368_1E - ATTACHMENT			
Clause	Requirement + Test	Result - Remark	Verdict
10.6.3.1	<p>General</p> <p>Previous limits (10.6.2) created abundant false negative and false positive PMP sound level warnings. New limits, compliant with The Commission Decision of 23 June 2009, are given below.</p>		N/A
10.6.3.2	<p>RS1 limits (new)</p> <p>RS1 is a class 1 acoustic energy source that does not exceed the following:</p> <ul style="list-style-type: none"> – for equipment provided as a package (player with its listening device), and with a proprietary connector between the player and its listening device, or where the combination of player and listening device is known by other means such as setting or automatic detection, the $L_{Aeq,T}$ acoustic output shall be ≤ 80 dB when playing the fixed "programme simulation noise" described in EN 50332-1. – for equipment provided with a standardized connector (for example, a 3,5 phone jack) that allows connection to a listening device for general use, the unweighted r.m.s. output voltage shall be ≤ 15 mV (analogue interface) or -30 dBFS (digital interface) when playing the fixed "programme simulation noise" described in EN 50332-1. 		N/A
10.6.3.3	<p>RS2 limits (new)</p> <p>RS2 is a class 2 acoustic energy source that does not exceed the following:</p> <ul style="list-style-type: none"> – for equipment provided as a package (player with its listening device), and with a proprietary connector between the player and its listening device, or where the combination of player and listening device is known by other means such as setting or automatic detection, the weekly sound exposure level, as described in EN 50332-3, shall be ≤ 80 dB when playing the fixed "programme simulation noise" described in EN 50332-1. – for equipment provided with a standardized connector (for example, a 3,5 phone jack) that allows connection to a listening device for general use, the unweighted r.m.s. output level, integrated over one week, as described in EN 50332-3, shall be ≤ 15 mV (analogue interface) or -30 dBFS (digital interface) when playing the fixed "programme simulation noise" described in 		N/A

IEC62368_1E - ATTACHMENT			
Clause	Requirement + Test	Result - Remark	Verdict
	EN 50332-1.		
10.6.4	Requirements for maximum sound exposure		N/A
10.6.4.1	<p>Measurement methods</p> <p>All volume controls shall be turned to maximum during tests.</p> <p>Measurements shall be made in accordance with EN 50332-1 or EN 50332-2 as applicable.</p>		N/A
10.6.4.2	<p>Protection of persons</p> <p>Except as given below, protection requirements for parts accessible to ordinary persons, instructed persons and skilled persons are given in 4.3.</p> <p>NOTE 1 Volume control is not considered a safeguard.</p> <p>Between RS2 and an ordinary person, the basic safeguard may be replaced by an instructional safeguard in accordance with Clause F.5, except that the instructional safeguard shall be placed on the equipment, or on the packaging, or in the instruction manual.</p> <p>Alternatively, the instructional safeguard may be given through the equipment display during use.</p> <p>The elements of the instructional safeguard shall be as follows:</p> <p>– element 1a: the symbol , IEC 60417-6044 (2011-01)</p> <p>– element 2: “High sound pressure” or equivalent wording</p> <p>– element 3: “Hearing damage risk” or equivalent wording</p> <p>– element 4: “Do not listen at high volume levels for long periods.” or equivalent wording</p> <p>An equipment safeguard shall prevent exposure of an ordinary person to an RS2 source without intentional physical action from the ordinary person and shall automatically return to an output level not exceeding what is specified for an RS1 source when the power is switched off.</p>		N/A

IEC62368_1E - ATTACHMENT			
Clause	Requirement + Test	Result - Remark	Verdict
	<p>The equipment shall provide a means to actively inform the user of the increased sound level when the equipment is operated with an output exceeding RS1. Any means used shall be acknowledged by the user before activating a mode of operation which allows for an output exceeding RS1. The acknowledgement does not need to be repeated more than once every 20 h of cumulative listening time.</p> <p>NOTE 2 Examples of means include visual or audible signals. Action from the user is always needed.</p> <p>NOTE 3 The 20 h listening time is the accumulative listening time, independent of how often and how long the personal music player has been switched off.</p> <p>A skilled person shall not be unintentionally exposed to RS3.</p>		
10.6.5	Requirements for dose-based systems		N/A
10.6.5.1	<p>General requirements</p> <p>Personal music players shall give the warnings as provided below when tested according to EN 50332-3, using the limits from this clause.</p> <p>The manufacturer may offer optional settings to allow the users to modify when and how they wish to receive the notifications and warnings to promote a better user experience without defeating the safeguards. This allows the users to be informed in a method that best meets their physical capabilities and device usage needs. If such optional settings are offered, an administrator (for example, parental restrictions, business/educational administrators, etc.) shall be able to lock any optional settings into a specific configuration.</p> <p>The personal music player shall be supplied with easy to understand explanation to the user of the dose management system, the risks involved, and how to use the system safely. The user shall be made aware that other sources may significantly contribute to their sound exposure, for example work, transportation, concerts, clubs, cinema, car races, etc.</p>		N/A

IEC62368_1E - ATTACHMENT			
Clause	Requirement + Test	Result - Remark	Verdict
10.6.5.2	<p>Dose-based warning and requirements</p> <p>When a dose of 100 % CSD is reached, and at least at every 100 % further increase of CSD, the device shall warn the user and require an acknowledgement. In case the user does not acknowledge, the output level shall automatically decrease to compliance with class RS1.</p> <p>The warning shall at least clearly indicate that listening above 100 % CSD leads to the risk of hearing damage or loss.</p>		N/A
10.6.5.3	<p>Exposure-based requirements</p> <p>With only dose-based requirements, cause and effect could be far separated in time, defying the purpose of educating users about safe listening practice. In addition to dose-based requirements, a PMP shall therefore also put a limit to the short-term sound level a user can listen at.</p> <p>The exposure-based limiter (EL) shall automatically reduce the sound level not to exceed 100 dB(A) or 150 mV integrated over the past 180 s, based on methodology defined in EN 50332-3.</p> <p>The EL settling time (time from starting level reduction to reaching target output) shall be 10 s or faster.</p> <p>Test of EL functionality is conducted according to EN 50332-3, using the limits from this clause. For equipment provided as a package (player with its listening device), the level integrated over 180 s shall be 100 dB or lower. For equipment provided with a standardized connector, the unweighted level integrated over 180 s shall be no more than 150 mV for an analogue interface and no more than -10 dBFS for a digital interface.</p> <p>NOTE In case the source is known not to be music (or test signal), the EL may be disabled.</p>		N/A

IEC62368_1E - ATTACHMENT			
Clause	Requirement + Test	Result - Remark	Verdict
10.6.6	Requirements for listening devices (headphones, earphones, etc.)		N/A
10.6.6.1	<p>Corded listening devices with analogue input</p> <p>With 94 dB L_{Aeq} acoustic pressure output of the listening device, and with the volume and sound settings in the listening device (for example, built-in volume level control, additional sound features like equalization, etc.) set to the combination of positions that maximize the measured acoustic output, the input voltage of the listening device when playing the fixed “programme simulation noise” as described in EN 50332-1 shall be ≥ 75 mV.</p> <p>NOTE The values of 94 dB and 75 mV correspond with 85 dB and 27 mV or 100 dB and 150 mV.</p>		N/A
10.6.6.2	<p>Corded listening devices with digital input</p> <p>With any playing device playing the fixed “programme simulation noise” described in EN 50332-1, and with the volume and sound settings in the listening device (for example, built-in volume level control, additional sound features like equalization, etc.) set to the combination of positions that maximize the measured acoustic output, the $L_{Aeq,T}$ acoustic output of the listening device shall be ≤ 100 dB with an input signal of -10 dBFS.</p>		N/A
10.6.6.3	<p>Cordless listening devices</p> <p>In cordless mode,</p> <ul style="list-style-type: none"> – with any playing and transmitting device playing the fixed programme simulation noise described in EN 50332-1; and – respecting the cordless transmission standards, where an air interface standard exists that specifies the equivalent acoustic level; and – with volume and sound settings in the receiving device (for example, built-in volume level control, additional sound features like equalization, etc.) set to the combination of positions that maximize the measured acoustic output for the above mentioned programme simulation noise, the $L_{Aeq,T}$ acoustic output of the listening device shall be ≤ 100 dB with an input signal of -10 dBFS. 		N/A
10.6.6.4	Measurement method		N/A

IEC62368_1E - ATTACHMENT																																																																		
Clause	Requirement + Test				Result - Remark	Verdict																																																												
	<i>Measurements shall be made in accordance with EN 50332-2 as applicable.</i>																																																																	
3	Modification to the whole document																																																																	
	<p>Delete all the "country" notes in the reference document according to the following list:</p> <table border="1"> <tr> <td>0.2.1</td> <td>Note 1 and 2</td> <td>1</td> <td>Note 4 and 5</td> <td>3.3.8.1</td> <td>Note 2</td> </tr> <tr> <td>3.3.8.3</td> <td>Note 1</td> <td>4.1.15</td> <td>Note</td> <td>4.7.3</td> <td>Note 1 and 2</td> </tr> <tr> <td>5.2.2.2</td> <td>Note</td> <td>5.4.2.3.2.2 Table 12</td> <td>Note c</td> <td>5.4.2.3.2.4</td> <td>Note 1 and 3</td> </tr> <tr> <td>5.4.2.3.2.4 Table 13</td> <td>Note 2</td> <td>5.4.2.5</td> <td>Note 2</td> <td>5.4.5.1</td> <td>Note</td> </tr> <tr> <td>5.4.10.2.1</td> <td>Note</td> <td>5.4.10.2.2</td> <td>Note</td> <td>5.4.10.2.3</td> <td>Note</td> </tr> <tr> <td>5.5.2.1</td> <td>Note</td> <td>5.5.6</td> <td>Note</td> <td>5.6.4.2.1</td> <td>Note 2 and 3 and 4</td> </tr> <tr> <td>5.6.8</td> <td>Note 2</td> <td>5.7.6</td> <td>Note</td> <td>5.7.7.1</td> <td>Note 1 and Note 2</td> </tr> <tr> <td>8.5.4.2.3</td> <td>Note</td> <td>10.2.1 Table 39</td> <td>Note 3 and 4 and 5</td> <td>10.5.3</td> <td>Note 2</td> </tr> <tr> <td>10.6.1</td> <td>Note 3</td> <td>F.3.3.6</td> <td>Note 3</td> <td>Y.4.1</td> <td>Note</td> </tr> <tr> <td>Y.4.5</td> <td>Note</td> <td></td> <td></td> <td></td> <td></td> </tr> </table>					0.2.1	Note 1 and 2	1	Note 4 and 5	3.3.8.1	Note 2	3.3.8.3	Note 1	4.1.15	Note	4.7.3	Note 1 and 2	5.2.2.2	Note	5.4.2.3.2.2 Table 12	Note c	5.4.2.3.2.4	Note 1 and 3	5.4.2.3.2.4 Table 13	Note 2	5.4.2.5	Note 2	5.4.5.1	Note	5.4.10.2.1	Note	5.4.10.2.2	Note	5.4.10.2.3	Note	5.5.2.1	Note	5.5.6	Note	5.6.4.2.1	Note 2 and 3 and 4	5.6.8	Note 2	5.7.6	Note	5.7.7.1	Note 1 and Note 2	8.5.4.2.3	Note	10.2.1 Table 39	Note 3 and 4 and 5	10.5.3	Note 2	10.6.1	Note 3	F.3.3.6	Note 3	Y.4.1	Note	Y.4.5	Note					P
0.2.1	Note 1 and 2	1	Note 4 and 5	3.3.8.1	Note 2																																																													
3.3.8.3	Note 1	4.1.15	Note	4.7.3	Note 1 and 2																																																													
5.2.2.2	Note	5.4.2.3.2.2 Table 12	Note c	5.4.2.3.2.4	Note 1 and 3																																																													
5.4.2.3.2.4 Table 13	Note 2	5.4.2.5	Note 2	5.4.5.1	Note																																																													
5.4.10.2.1	Note	5.4.10.2.2	Note	5.4.10.2.3	Note																																																													
5.5.2.1	Note	5.5.6	Note	5.6.4.2.1	Note 2 and 3 and 4																																																													
5.6.8	Note 2	5.7.6	Note	5.7.7.1	Note 1 and Note 2																																																													
8.5.4.2.3	Note	10.2.1 Table 39	Note 3 and 4 and 5	10.5.3	Note 2																																																													
10.6.1	Note 3	F.3.3.6	Note 3	Y.4.1	Note																																																													
Y.4.5	Note																																																																	
4	Modification to Clause 1																																																																	
1	<p>Add the following note:</p> <p><i>NOTE Z1 The use of certain substances in electrical and electronic equipment is restricted within the EU: see Directive 2011/65/EU.</i></p>					P																																																												

IEC62368_1E - ATTACHMENT			
Clause	Requirement + Test	Result - Remark	Verdict
5	Modification to 4.Z1		
4.Z1	<p>Add the following new subclause after 4.9:</p> <p>To protect against excessive current, short-circuits and earth faults in circuits connected to an a.c. mains, protective devices shall be included either as integral parts of the equipment or as parts of the building installation, subject to the following, a), b) and c):</p> <p>a) except as detailed in b) and c), protective devices necessary to comply with the requirements of B.3.1 and B.4 shall be included as parts of the equipment;</p> <p>b) for components in series with the mains input to the equipment such as the supply cord, appliance coupler, r.f.i. filter and switch, short-circuit and earth fault protection may be provided by protective devices in the building installation;</p> <p>c) it is permitted for pluggable equipment type B or permanently connected equipment, to rely on dedicated overcurrent and short-circuit protection in the building installation, provided that the means of protection, e.g. fuses or circuit breakers, is fully specified in the installation instructions.</p> <p>If reliance is placed on protection in the building installation, the installation instructions shall so state, except that for pluggable equipment type A the building installation shall be regarded as providing protection in accordance with the rating of the wall socket outlet.</p>		P
6	Modification to 5.4.2.3.2.4		
5.4.2.3.2.4	<p>Add the following to the end of this subclause:</p> <p>The requirement for interconnection with external circuit is in addition given in EN 50491-3:2009.</p>		N/A
7	Modification to 10.2.1		
10.2.1	<p>Add the following to ^{c)} and ^{d)} in table 39:</p> <p>For additional requirements, see 10.5.1.</p>		N/A

IEC62368_1E - ATTACHMENT			
Clause	Requirement + Test	Result - Remark	Verdict
8	Modification to 10.5.1		
10.5.1	<p>Add the following after the first paragraph:</p> <p>For RS 1 compliance is checked by measurement under the following conditions:</p> <p>In addition to the normal operating conditions, all controls adjustable from the outside by hand, by any object such as a tool or a coin, and those internal adjustments or pre-sets which are not locked in a reliable manner, are adjusted so as to give maximum radiation whilst maintaining an intelligible picture for 1 h, at the end of which the measurement is made.</p> <p>NOTE Z1 Soldered joints and paint lockings are examples of adequate locking.</p> <p>The dose-rate is determined by means of a radiation monitor with an effective area of 10 cm², at any point 10 cm from the outer surface of the apparatus.</p> <p>Moreover, the measurement shall be made under fault conditions causing an increase of the high voltage, provided an intelligible picture is maintained for 1 h, at the end of which the measurement is made.</p> <p>For RS1, the dose-rate shall not exceed 1 μSv/h taking account of the background level.</p> <p>NOTE Z2 These values appear in Directive 96/29/Euratom of 13 May 1996.</p>		N/A
9	Modification to G.7.1		
G.7.1	<p>Add the following note:</p> <p>NOTE Z1 The harmonized code designations corresponding to the IEC cord types are given in AnnexZD.</p>		P

IEC62368_1E - ATTACHMENT			
Clause	Requirement + Test	Result - Remark	Verdict
10	Modification to Bibliography		
	<p>Add the following notes for the standards indicated:</p> <p>IEC 60130-9 NOTE Harmonized as EN 60130-9. IEC 60269-2 NOTE Harmonized as HD 60269-2. IEC 60309-1 NOTE Harmonized as EN 60309-1. IEC 60364 NOTE some parts harmonized in HD 384/HD 60364 series. IEC 60601-2-4 NOTE Harmonized as EN 60601-2-4. IEC 60664-5 NOTE Harmonized as EN 60664-5. IEC 61032:1997 NOTE Harmonized as EN 61032:1998 (not modified). IEC 61508-1 NOTE Harmonized as EN 61508-1. IEC 61558-2-1 NOTE Harmonized as EN 61558-2-1. IEC 61558-2-4 NOTE Harmonized as EN 61558-2-4. IEC 61558-2-6 NOTE Harmonized as EN 61558-2-6. IEC 61643-1 NOTE Harmonized as EN 61643-1. IEC 61643-21 NOTE Harmonized as EN 61643-21. IEC 61643-311 NOTE Harmonized as EN 61643-311. IEC 61643-321 NOTE Harmonized as EN 61643-321. IEC 61643-331 NOTE Harmonized as EN 61643-331.</p>		P
11	ADDITION OF ANNEXES		
ZB	ANNEX ZB, SPECIAL NATIONAL CONDITIONS (EN)		P

IEC62368_1E - ATTACHMENT			
Clause	Requirement + Test	Result - Remark	Verdict
4.1.15	<p>Denmark, Finland, Norway and Sweden</p> <p>To the end of the subclause the following is added:</p> <p>Class I pluggable equipment type A intended for connection to other equipment or a network shall, if safety relies on connection to reliable earthing or if surge suppressors are connected between the network terminals and accessible parts, have a marking stating that the equipment shall be connected to an earthed mains socket-outlet.</p> <p>The marking text in the applicable countries shall be as follows:</p> <p>In Denmark: "Apparatets stikprop skal tilsluttes en stikkontakt med jord som giver forbindelse til stikproppens jord."</p> <p>In Finland: "Laite on liitettävä suojakoskettimilla varustettuun pistorasiaan"</p> <p>In Norway: "Apparatet må tilkoples jordet stikkontakt"</p> <p>In Sweden: "Apparaten skall anslutas till jordat uttag"</p>		N/A

IEC62368_1E - ATTACHMENT			
Clause	Requirement + Test	Result - Remark	Verdict
4.7.3	<p>United Kingdom</p> <p>To the end of the subclause the following is added:</p> <p>The torque test is performed using a socket-outlet complying with BS 1363, and the plug part shall be assessed to the relevant clauses of BS 1363. Also see Annex G.4.2 of this annex</p>		N/A
5.2.2.2	<p>Denmark</p> <p>After the 2nd paragraph add the following:</p> <p>A warning (marking safeguard) for high touch current is required if the touch current exceeds the limits of 3,5 mA a.c. or 10 mA d.c.</p>		N/A
5.4.11.1 and Annex G	<p>Finland and Sweden</p> <p>To the end of the subclause the following is added:</p> <p>For separation of the telecommunication network from earth the following is applicable:</p> <p>If this insulation is solid, including insulation forming part of a component, it shall at least consist of either</p> <ul style="list-style-type: none"> • two layers of thin sheet material, each of which shall pass the electric strength test below, or • one layer having a distance through insulation of at least 0,4 mm, which shall pass the electric strength test below. <p>If this insulation forms part of a semiconductor component (e.g. an optocoupler), there is no distance through insulation requirement for the insulation consisting of an insulating compound completely filling the casing, so that clearances and creepage distances do not exist, if the component passes the electric strength test in accordance with the compliance clause below and in addition</p> <ul style="list-style-type: none"> • passes the tests and inspection criteria of 5.4.8 		N/A

IEC62368_1E - ATTACHMENT			
Clause	Requirement + Test	Result - Remark	Verdict
	<p>with an electric strength test of 1,5 kV multiplied by 1,6 (the electric strength test of 5.4.9 shall be performed using 1,5 kV),</p> <p>and</p> <ul style="list-style-type: none"> • is subject to routine testing for electric strength during manufacturing, using a test voltage of 1,5 kV. <p>It is permitted to bridge this insulation with a capacitor complying with EN 60384-14:2005, subclass Y2.</p> <p>A capacitor classified Y3 according to EN 60384-14:2005, may bridge this insulation under the following conditions:</p> <ul style="list-style-type: none"> • the insulation requirements are satisfied by having a capacitor classified Y3 as defined by EN 60384-14, which in addition to the Y3 testing, is tested with an impulse test of 2,5 kV defined in 5.4.11; • the additional testing shall be performed on all the test specimens as described in EN 60384-14; <p>the impulse test of 2,5 kV is to be performed before the endurance test in EN 60384-14, in the sequence of tests as described in EN 60384-14.</p>		
5.5.2.1	<p>Norway</p> <p>After the 3rd paragraph the following is added:</p> <p>Due to the IT power system used, capacitors are required to be rated for the applicable line-to-line voltage (230 V).</p>		N/A

IEC62368_1E - ATTACHMENT			
Clause	Requirement + Test	Result - Remark	Verdict
5.5.6	<p>Finland, Norway and Sweden</p> <p>To the end of the subclause the following is added:</p> <p>Resistors used as basic safeguard or bridging basic insulation in class I pluggable equipment type A shall comply with G.10.1 and the test of G.10.2.</p>		N/A
5.6.1	<p>Denmark</p> <p>Add to the end of the subclause</p> <p>Due to many existing installations where the socket-outlets can be protected with fuses with higher rating than the rating of the socket-outlets the protection for pluggable equipment type A shall be an integral part of the equipment.</p> <p><i>Justification:</i></p> <p>In Denmark an existing 13 A socket outlet can be protected by a 20 A fuse.</p>		N/A
5.6.4.2.1	<p>Ireland and United Kingdom</p> <p>After the indent for pluggable equipment type A, the following is added:</p> <p>– the protective current rating is taken to be 13 A, this being the largest rating of fuse used in the mains plug.</p>		N/A
5.6.4.2.1	<p>France</p> <p>After the indent for pluggable equipment type A, the following is added:</p> <p>– in certain cases, the protective current rating of the circuit supplied from the mains is taken as 20 A instead of 16 A.</p>		N/A
5.6.5.1	<p>To the second paragraph the following is added:</p> <p>The range of conductor sizes of flexible cords to be accepted by terminals for equipment with a rated current over 10 A and up to and including 13 A is:</p> <p>1,25 mm²to 1,5 mm²in cross-sectional area.</p>		N/A

IEC62368_1E - ATTACHMENT			
Clause	Requirement + Test	Result - Remark	Verdict
5.6.8	<p>Norway</p> <p>To the end of the subclause the following is added:</p> <p>Equipment connected with an earthed mains plug is classified as class I equipment. See the Norway marking requirement in 4.1.15. The symbol IEC 60417-6092, as specified in F.3.6.2, is accepted.</p>		N/A
5.7.6	<p>Denmark</p> <p>To the end of the subclause the following is added:</p> <p>The installation instruction shall be affixed to the equipment if the protective conductor current exceeds the limits of 3,5 mA a.c. or 10 mA d.c.</p>		N/A
5.7.6.2	<p>Denmark</p> <p>To the end of the subclause the following is added:</p> <p>The warning (marking safeguard) for high touch current is required if the touch current or the protective current exceed the limits of 3,5 mA .</p>		N/A
5.7.7.1	<p>Norway and Sweden</p> <p>To the end of the subclause the following is added:</p> <p>The screen of the television distribution system is normally not earthed at the entrance of the building and there is normally no equipotential bonding system within the building.</p> <p>Therefore the protective earthing of the building installation needs to be isolated from the screen of a cable distribution system.</p> <p>It is however accepted to provide the insulation external to the equipment by an adapter or an interconnection cable with galvanic isolator, which may be provided by a retailer, for example.</p> <p>The user manual shall then have the following or similar information in Norwegian and Swedish language respectively, depending on in what country the equipment is intended to be used in:</p> <p>“Apparatus connected to the protective earthing of</p>		N/A

IEC62368_1E - ATTACHMENT			
Clause	Requirement + Test	Result - Remark	Verdict
	<p>the building installation through the mains connection or through other apparatus with a connection to protective earthing –</p> <p>and to a television distribution system using coaxial cable, may in some circumstances create a fire hazard. Connection to a television distribution system therefore has to be provided through a device providing electrical isolation below a certain frequency range (galvanic isolator, see EN 60728-11)”</p> <p>NOTE In Norway, due to regulation for CATV-installations, and in Sweden, a galvanic isolator shall provide electrical insulation below 5 MHz. The insulation shall withstand a dielectric strength of 1,5 kV r.m.s., 50 Hz or 60 Hz, for 1 min.</p> <p>Translation to Norwegian (the Swedish text will also be accepted in Norway):</p> <p>“Apparater som er koplet til beskyttelsesjord via nettplugg og/eller via annet jordtilkoplet utstyr – og er tilkoplet et koaksialbasert kabel-TV nett, kan forårsake brannfare.</p> <p>For å unngå dette skal det ved tilkopling av apparater til kabel-TV nett installeres en galvanisk isolator mellom apparatet og kabel-TV nettet.”</p> <p>Translation to Swedish:</p> <p>”Apparater som är kopplad till skyddsjord via jordat vägguttag och/eller via annan utrustning och samtidigt är kopplad till kabel-TV nät kan i vissa fall medföra risk för brand. För att undvika detta skall vid anslutning av apparaten till kabel-TV nät galvanisk isolator finnas mellan apparaten och kabel-TV nätet.”.</p>		
8.5.4.2.3	<p>United Kingdom</p> <p>Add the following after the 2nddash bullet in 3rdparagraph:</p> <p>An emergency stop system complying with the requirements of IEC 60204-1 and ISO 13850 is required where there is a risk of personal injury.</p>		N/A

IEC62368_1E - ATTACHMENT			
Clause	Requirement + Test	Result - Remark	Verdict
B.3.1 and B.4	<p>Ireland and United Kingdom</p> <p>The following is applicable:</p> <p>To protect against excessive currents and short-circuits in the primary circuit of direct plug-in equipment, tests according to Annexes B.3.1 and B.4 shall be conducted using an external miniature circuit breaker complying with EN 60898-1, Type B, rated 32A. If the equipment does not pass these tests, suitable protective devices shall be included as an integral part of the direct plug-in equipment, until the requirements of Annexes B.3.1 and B.4 are met</p>		N/A

IEC62368_1E - ATTACHMENT			
Clause	Requirement + Test	Result - Remark	Verdict
G.4.2	<p>Denmark</p> <p>To the end of the subclause the following is added:</p> <p>Supply cords of single phase appliances having a rated current not exceeding 13 A shall be provided with a plug according to DS 60884-2-D1:2011.</p> <p>CLASS I EQUIPMENT provided with socket-outlets with earth contacts or which are intended to be used in locations where protection against indirect contact is required according to the wiring rules shall be provided with a plug in accordance with standard sheet DK 2-1a or DK 2-5a.</p> <p>If a single-phase equipment having a RATED CURRENT exceeding 13 A or if a polyphase equipment is provided with a supply cord with a plug, this plug shall be in accordance with the standard sheets DK 6-1a in DS 60884-2-D1 or EN 60309-2.</p> <p>Mains socket outlets intended for providing power to Class II apparatus with a rated current of 2,5 A shall be in accordance DS 60884-2-D1:2011 standard sheet DKA 1-4a.</p> <p>Other current rating socket outlets shall be in compliance with Standard Sheet DKA 1-3a or DKA 1-1c.</p> <p>Mains socket-outlets with earth shall be in compliance with DS 60884-2-D1:2011 Standard Sheet DK 1-3a, DK 1-1c, DK1-1d, DK 1-5a or DK 1-7a</p> <p><i>Justification:</i> Heavy Current Regulations, Section 6c</p>		N/A

IEC62368_1E - ATTACHMENT			
Clause	Requirement + Test	Result - Remark	Verdict
G.4.2	<p>United Kingdom</p> <p>To the end of the subclause the following is added:</p> <p>The plug part of direct plug-in equipment shall be assessed to BS 1363: Part 1, 12.1, 12.2, 12.3, 12.9, 12.11, 12.12, 12.13, 12.16, and 12.17, except that the test of 12.17 is performed at not less than 125 °C. Where the metal earth pin is replaced by an Insulated Shutter Opening Device (ISOD), the requirements of clauses 22.2 and 23 also apply.</p>		N/A
G.7.1	<p>United Kingdom</p> <p>To the first paragraph the following is added:</p> <p>Equipment which is fitted with a flexible cable or cord and is designed to be connected to a mains socket conforming to BS 1363 by means of that flexible cable or cord shall be fitted with a 'standard plug' in accordance with the Plugs and Sockets etc. (Safety) Regulations 1994, Statutory Instrument 1994 No. 1768, unless exempted by those regulations.</p> <p>NOTE "Standard plug" is defined in SI 1768:1994 and essentially means an approved plug conforming to BS 1363 or an approved conversion plug.</p>		N/A
G.7.1	<p>Ireland</p> <p>To the first paragraph the following is added:</p> <p>Apparatus which is fitted with a flexible cable or cord shall be provided with a plug in accordance with Statutory Instrument 525: 1997, "13 A Plugs and Conversion Adapters for Domestic Use Regulations: 1997. S.I. 525 provides for the recognition of a standard of another Member State which is equivalent to the relevant Irish Standard</p>		N/A

IEC62368_1E - ATTACHMENT			
Clause	Requirement + Test	Result - Remark	Verdict
G.7.2	<p>Ireland and United Kingdom</p> <p>To the first paragraph the following is added:</p> <p>A power supply cord with a conductor of 1,25 mm² is allowed for equipment which is rated over 10 A and up to and including 13 A.</p>		N/A

IEC62368_1E - ATTACHMENT			
Clause	Requirement + Test	Result - Remark	Verdict
ZC	ANNEX ZC, NATIONAL DEVIATIONS (EN)		N/A
10.5.2	<p>Germany</p> <p>The following requirement applies:</p> <p>For the operation of any cathode ray tube intended for the display of visual images operating at an acceleration voltage exceeding 40 kV, authorization is required, or application of type approval (Bauartzulassung) and marking.</p> <p><i>Justification:</i></p> <p>German ministerial decree against ionizing radiation (Röntgenverordnung), in force since 2002-07-01, implementing the European Directive 96/29/EURATOM.</p> <p>NOTE Contact address: Physikalisch-Technische Bundesanstalt, Bundesallee 100, D-38116 Braunschweig, Tel.: Int+49-531-592-6320, Internet: http://www.ptb.de</p>		N/A

IEC62368_1E - ATTACHMENT			
Clause	Requirement + Test	Result - Remark	Verdict

ZD	IEC and CENELEC CODE DESIGNATIONS FOR FLEXIBLE CORDS (EN)		P					
	<table border="1"> <thead> <tr> <th rowspan="2">Type of flexible cord</th> <th colspan="2">Code designations</th> </tr> <tr> <th>IEC</th> <th>CENELEC</th> </tr> </thead> </table>		Type of flexible cord	Code designations		IEC	CENELEC	P
Type of flexible cord	Code designations							
	IEC	CENELEC						
	PVC insulated cords							
	Flat twin tinsel cord	60227 IEC 41 H03VH-Y						
	Light polyvinyl chloride sheathed flexible cord	60227 IEC 52 H03VV-F H03VVH2-F						
	Ordinary polyvinyl chloride sheathed flexible cord	60227 IEC 53 H05VV-F H05VVH2-F						
	Rubber insulated cords							
	Braided cord	60245 IEC 51 H03RT-F						
	Ordinary tough rubber sheathed flexible cord	60245 IEC 53 H05RR-F						
	Ordinary polychloroprene sheathed flexible cord	60245 IEC 57 H05RN-F						
	Heavy polychloroprene sheathed flexible cord	60245 IEC 66 H07RN-F						
	Cords having high flexibility							
	Rubber insulated and sheathed cord	60245 IEC 86 H03RR-H						
	Rubber insulated, crosslinked PVC sheathed cord	60245 IEC 87 H03RV4-H						
	Crosslinked PVC insulated and sheathed cord	60245 IEC 88 H03V4V4-H						
	Cords insulated and sheathed with halogen-free thermoplastic compounds							
	Light halogen-free thermoplastic insulated and sheathed flexible cords	H03Z1Z1-F H03Z1Z1H2-F						
	Ordinary halogen-free thermoplastic insulated and sheathed flexible cords	H05Z1Z1-F H05Z1Z1H2-F						

IEC62368_1E - ATTACHMENT			
Clause	Requirement + Test	Result - Remark	Verdict

Appendix No.3: National differences for USA and Canada

ATTACHMENT TO TEST REPORT IEC 62368-1 U.S.A. AND CANADA NATIONAL DIFFERENCES (AUDIO/VIDEO, INFORMATION AND COMMUNICATION TECHNOLOGY EQUIPMENT – PART 1: SAFETY REQUIREMENTS)			
Differences according to: CSA/UL 62368-1:2019			
TRF template used :: IECEE OD-2020-F3, Ed. 1.1			
Attachment Form No.: US_CA_ND_IEC62368_1E			
Attachment Originator: UL(US)			
Master Attachment: Dated 2022-03-04			
Copyright © 2022 IEC System for Conformity Testing and Certification of Electrical Equipment (IECEE), Geneva, Switzerland. All rights reserved.			
IEC 62368-1 - US and Canadian National Differences Special National Conditions based on Regulations and Other National Differences			
1 (1DV.1) (1.3)	All equipment is to be designed to allow installation in accordance with the National Electrical Code (NEC), ANSI/NFPA 70, the Canadian Electrical Code (CEC), Part 1, CAN/CSA C22.1, and when applicable, the National Electrical Safety Code, IEEE C2. Also, for such equipment marked or otherwise identified, installation is allowed per the Standard for the Protection of Information Technology Equipment, ANSI/NFPA 75.		P
1 (1DV.2.1)	This standard includes additional requirements for equipment used for entertainment purposes intended for installation in general patient care areas of health care facilities. See Annex DVB.		N/A
1 (1DV.2.2)	This standard includes additional requirements for equipment intended for mounting under cabinets. See Annex DVC.		N/A
1 (1DV.2.3)	IEC 62368-3 clause 5 for DC power transfer at ES1 or ES2 voltage levels is considered informative. IEC 62368-3 clause 6 for remote power feeding telecommunication (RFT) circuits is considered normative (see ITU K.50). Alternatively, equipment with RFT circuits are given in either UL 2391 or CSA/UL 60950-21. RFT-C circuits are not permitted unless the RFT-C circuit complies with RFT-V limits ($\leq 200V$ per conductor to earth).		N/A

IEC62368_1E - ATTACHMENT			
Clause	Requirement + Test	Result - Remark	Verdict
1 (1DV.3)	For protection against direct lightning strikes, reference is made to NFPA 780 and CAN/CSA-B72 for additional requirements.		N/A
1 (DV.5)	Additional requirements apply to some forms of power distribution equipment, including sub-assemblies.	Considered.	P
4.1 (4.1.17)	<i>For lengths exceeding 3.05 m, external interconnecting cable assemblies are required to be a suitable cable type (e.g., DP, CL2) specified in the NEC.</i>	Should be evaluated during national approval.	N/A
	<i>For lengths 3.05 m or less, external interconnecting cable assemblies that are not types specified in the NEC generally are required to have special construction features and identification markings.</i>	Should be evaluated during national approval.	N/A
4.6 (4.6.2)	Wire-wrap terminals have special construction and performance requirements.		N/A
4.8 (4.8.3, 4.8.4.5, 4.8.5)	Coin / button cell batteries have modified special construction and performance requirements.		N/A
5.4.2.3.2 (5.4.2.3.2.1)	<i>Surge Arrestors and Transient Voltage Surge Suppressors installed external to the equipment are required to comply with the appropriate NEC and CEC requirements.</i>		N/A
5.5.9	Receptacles, rated 125-V, single phase, 15- or 20-A accessible to either ordinary, instructed, or skilled persons are required to be provided with GFCI Protection for Personnel if the equipment containing the receptacles is installed outdoors. The protection devices are required to comply with UL 943, and CAN/CSA C22.2 No.144.		N/A

IEC62368_1E - ATTACHMENT			
Clause	Requirement + Test	Result - Remark	Verdict
5.6.3	Protective earthing conductors comply with the minimum conductor sizes in Table G.7, except as required by Table G.7ADV.1 for cord connected equipment, or Annex DVH for permanently connected equipment.		N/A
5.7.8 (5.7.8.1)	Equipment intended to receive telecommunication ringing signals is required to comply with a special touch current measurement tests.	Not such equipment	N/A
6.5.1	PS3 wiring outside a fire enclosure is required to comply with single fault testing in B.4, or be current limited per one of the permitted methods.		N/A
Annex F (F.3.3.9)	Output terminals provided for supply of other equipment, except mains supply, are required to be marked with a maximum rating or reference to equipment permitted to be connected.		P
Annex F (F.3.7)	Outdoor Enclosures are required to be classified and marked in accordance with UL 50 or 50E, or CAN/CSA C22.2 No. 94.1 or 94.2.		N/A
Annex G (G.7)	Permanent connection of equipment to the mains supply by a power supply cord is not permitted, except for certain equipment, such as ATMs.		N/A
	Power supply cords are required to have attachment plugs rated not less than 125 percent of the rated current of the equipment.	Should be evaluated during national approval.	N/A
	Flexible power supply cords are required to be compatible with Article 400 of the NEC, and Tables 11 and 12 of the CEC.	Should be evaluated during national approval.	N/A
	Minimum cord length is required to be 1.5 m, with certain constructions such as external power supplies allowed to consider both input and output cord lengths into the requirement. Power supply cords are required to be no longer than 4.5 m in length if used in ITE Rooms.	Should be evaluated during national approval.	N/A
	Power supply cords for outdoor equipment are required to be suitable outdoor use type as required by Section 400.4 of the NEC and Rule 4-012 of the CEC, i.e., marked "W."		N/A
Annex H.2	Continuous ringing signals under normal operating conditions up to 16 mA only are permitted if the equipment is subjected to special installation and performance restrictions.		N/A
Annex H.4	For circuits with other than ringing signals and with voltages exceeding 42.4 V _{peak} or 60 V _{d.c.} , the maximum acceptable current through a 2000 ohm resistor (or greater) connected across the voltage source with other loads disconnected is 7.1 mA peak or 30 mA d.c. under normal operating conditions.		N/A

IEC62368_1E - ATTACHMENT			
Clause	Requirement + Test	Result - Remark	Verdict
Annex Q (Q.3)	Equipment with paired conductor and/or coax communications cables/wiring connected to building wiring are required to have special voltage, current, power and marking requirements.		N/A
Annex DVA (1)	Equipment that is designed such that it may be powered from a separate electrical service, is required to meet applicable requirements for service equipment for control and protection of services and their installation and complies with Article 230 of the National Electrical Code (NEC), NFPA 70 and Section 6 of the Canadian Electrical Code, Part I, CSA C22.1.	Not such equipment or application as below.	N/A
	Equipment intended for use in spaces used for environmental air (plenums) are subjected to special flammability requirements for heat and visible smoke release.		N/A
	For ITE room applications, automated information storage systems with combustible media greater than 0.76 m ³ (27 cu ft) are required to have a provision for connection of either automatic sprinklers or a gaseous agent extinguishing system with an extended discharge.		N/A
	Consumer products designed or intended primarily for children 12 years of age or younger are subject to additional requirements in accordance with U.S. and Canadian Regulations.		N/A
	Baby monitors are required to additionally comply with ASTM F2951, Consumer Safety Specification for Baby Monitors.		N/A
	Storage batteries and battery management equipment, other than associated with lead-acid batteries, and including battery backup systems that are not an integral part of stationary AV and ICT equipment, such as provided in separate cabinets, are required to be certified (listed) to the appropriate standard(s) for such storage batteries and equipment.		N/A
Annex DVA (5.6)	For Pluggable Equipment Type A, the protection in the installation is assumed to be 20A.		P
Annex DVA (6.3)	The maximum quantity of flammable liquid stored in equipment is required to comply with NFPA 30.		N/A

IEC62368_1E - ATTACHMENT			
Clause	Requirement + Test	Result - Remark	Verdict
Annex DVA (6.4.8)	For ITE room applications, enclosures with combustible material measuring greater than 0.9 m ² (10 sq ft) or a single dimension greater than 1.8 m (6 ft) are required to have a flame spread rating of 50 or less. For equipment with the same dimensions for other applications, an external surface that is not a fire enclosure requires a minimum flammability classification of V-1.		P
Annex DVA (10.3)	Equipment with lasers is required to meet the U.S. Code of Federal Regulations 21 CFR 1040 (and the Canadian Radiation Emitting Devices Act, REDR C1370).		N/A
Annex DVA (10.5)	Equipment that produces ionizing radiation is required to comply with the U.S. Code of Federal Regulations, 21 CFR 1020 (and the Canadian Radiation Emitting Devices Act, REDR C1370).		N/A
Annex DVA (F.3.3.4)	Equipment for use on a.c. mains supply systems with a neutral and more than one phase conductor (e.g. 120/240 V, 3-wire) require a special marking format for electrical ratings. Additional considerations apply for voltage ratings that exceed the attachment cap rating or that are lower than the "Normal Operating Condition" in Table 2 of CAN/CSA C22.2 No. 235."		N/A
Annex DVA (F.3.3.6)	Equipment identified for ITE (computer) room installation is required to be marked with the rated current.		N/A
Annex DVA (G.1)	Vertically-mounted disconnect switches and circuit breakers are required to have the "on" position indicated by the handle in the up position, where mounted in an enclosure, vertically mounted disconnect switches and circuit breakers with vertical operating means extending outside the enclosure are required to indicate in a location visible when accessing the external operating means whether the switch or circuit breaker is in the open (off) or closed (on) position.		N/A
Annex DVA (G.3.4)	Suitable NEC/CEC branch circuit protection rated at the maximum circuit rating is required for all standard supply outlets and receptacles (such as supplied in power distribution units) if the supply branch circuit protection is not suitable.		N/A
	Where a fuse is used to provide Class 2 or Class 3 current limiting, it is not operator-accessible unless it is non- interchangeable.	No such fuse provided	N/A
Annex DVA (G.4.2)	Equipment with isolated ground (earthing) receptacles is required to comply with NEC 250.146(D) and CEC 10-400 and 10-612.		N/A

IEC62368_1E - ATTACHMENT			
Clause	Requirement + Test	Result - Remark	Verdict
Annex DVA (G.4.3)	Interconnection of units by conductors supplied by a limited power source, or a Class 2 circuit defined in the NEC/CEC may have field wiring connections other than specified in DVH.3, such as wire-wrap and crimp-on types, if the limited power source and Class 2 circuits are separated from all other circuits by barriers, routing or fixing.		N/A
Annex DVA (G.5.3)	Power distribution transformers distributing power at 100 volts or more, and rated 10 kVA or more, require special transformer overcurrent protection.		N/A
Annex DVA (G.5.4)	Motor control devices are required for cord-connected equipment with a mains-connected motor if the equipment is rated more than 12 A, or if the equipment has a nominal voltage rating greater than 120 V, or if the motor is rated more than 1/3 hp (locked rotor current over 43 A).		N/A
Annex DVA (G.7)	Flexible cords used outdoors are required to have the suffix "W" marked on the flexible cord.		N/A
Annex DVA (M)	For ITE room applications, equipment with battery systems capable of supplying 750 VA for five minutes are required to have a battery disconnect means that may be connected to the ITE room remote power-off circuit.		N/A
Annex DVA (Q)	If applicable per NEC 725.121(C), some limited power sources supplied from AV/ICT equipment are required to have a label indicating the maximum voltage and rated current output for per conductor for each connection point. Where multiple connection points have the same rating, a single label is permitted to be used.		N/A
	Wiring terminals intended to supply Class 2 outputs in accordance with the NEC or CEC Part 1 are required to be marked with the voltage rating and "Class 2" or equivalent. The marking is located adjacent to the terminals and visible during wiring.		N/A
	Applicable parts of Chapter 8 of the NEC, and Rules 54 and 60 of the CEC, may be applicable to ITE installed outdoors with connections to communication systems.		N/A
Annex DVB (1)	Additional requirements apply for equipment used for entertainment purposes intended for installation in general patient care areas of health care facilities.		N/A
Annex DVC (1)	Additional requirements apply for equipment intended for mounting under kitchen cabinets.		N/A

IEC62368_1E - ATTACHMENT			
Clause	Requirement + Test	Result - Remark	Verdict
Annex DVE (4.1.1)	Some equipment, components, sub-assemblies and materials associated with the risk of fire, electric shock, or personal injury are required to have component or material ratings in accordance with the applicable national (U.S. and Canadian) component or material requirements. These equipment and components include: appliance couplers, attachment plugs, battery backup systems, circuit breakers, communication circuit accessories, connectors (used for current interruption of non-LPS circuits), direct plug-in equipment, electrochemical capacitor modules (energy storage modules with ultracapacitors), enclosures (outdoor), flexible cords and cables, fuses (branch circuit), ground-fault current interrupters, interconnecting cables, modular data centres, power supply cords, some power distribution equipment, printed wiring, protectors for communications circuits, receptacles, surge protective devices, vehicle battery adapters, wire connectors, and wire and cables.	See Table 4.1.2.	P
Annex DVH	Equipment for permanent connection to the mains supply is subjected to additional requirements.		N/A
Annex DVH (DVH.1)	Wiring methods (terminals, leads, etc.) used for the connection of the equipment to the mains are required to be in accordance with the NEC/CEC.	Inlet for detachable power cord	P
Annex DVH (DVH.2.1)	For safe and reliable connection to a mains, permanently connected equipment is to be provided.		N/A
Annex DVH (DVH.2.2)	Additional considerations for D.C. mains.		N/A
Annex DVH (DVH.3.2.1)	Terminals for permanent wiring, including protective earthing terminals, are required to be suitable for U.S./Canadian wire gauge sizes, rated 125 percent of the equipment rating, and be specially marked when specified.		N/A
Annex DVH (DVH.3.2.3)	Wire binding screws are not permitted to attach conductors larger than 10 AWG (5.3 mm ²).		N/A
Annex DVH (DVH.3.2.4)	All associated mains supply terminals are located in proximity to each other and to the main protective earthing terminal, if any.		N/A
Annex DVH (DVH.3.2.5)	Terminals are located, guarded or insulated so that, should a strand of a conductor escape when the conductor is fitted, there is no likelihood of accidental contact between such a strand and accessible conductive parts or unearthed conductive parts separated from accessible conductive parts by supplementary insulation only.		N/A

IEC62368_1E - ATTACHMENT			
Clause	Requirement + Test	Result - Remark	Verdict
Annex DVH (DVH.3.3)	When field connection to an external circuit is via wires (example, free conductors), the wires are not smaller than 18 AWG (0.82 mm ²) and the free length of the wire inside an outlet box or wiring compartment is 150 mm or more.		N/A
Annex DVH (DVH.3.4)	Size of protective earthing conductors and terminals	(See sub-clause 5.6.5)	N/A
Annex DVH (DVH.4)	Permanently connected equipment is required to have a suitable wiring compartment and wire bending space.		N/A
Annex DVH (DVH.4.1)	Wire bending space		N/A
Annex DVH (DVH.4.2)	Volume of wiring compartment		N/A
Annex DVH (DVH.4.3)	Separation of circuits		N/A
Annex DVH (DVH.5)	Equipment markings and instructional safeguards		N/A
Annex DVH (DVH.5.1)	Identification of protective earthing terminal		N/A
Annex DVH (DVH.5.2)	Identification of terminal for earthed conductor (neutral)		N/A
Annex DVH (DVH.5.3)	Identification of terminals for aluminium conductors		N/A
Annex DVH (DVH.5.4)	Wire temperature ratings		N/A
Annex DVH (DVH 5.5)	Equipment connected to a centralized d.c. power system, and having one pole of the DC mains input terminal connected to the main protective earthing terminal in the equipment, is required to comply with special earthing, wiring, marking and installation instruction requirements.		N/A
Annex DVI (6.7)	Equipment intended for connection to telecommunication network outside plant cable is required to be protected against overvoltage from power line crosses.		N/A
Annex DVJ (10.6.1)	Equipment connected to a telecommunication and cable distribution networks and supplied with an earphone intended to be held against, or in the ear is required to comply with special acoustic pressure requirements.		N/A

IEC62368_1E - ATTACHMENT			
Clause	Requirement + Test	Result - Remark	Verdict

Appendix No.4: National differences for Australia and New Zealand

ATTACHMENT TO TEST REPORT			
IEC 62368-1 (AUSTRALIA / NEW ZEALAND) NATIONAL DIFFERENCES (Audio/video, information and communication technology equipment)			
Differences according to : AS/NZS 62368.1:2022			
TRF template used:: IECEE OD-2020-F3, Ed. 1.1			
Attachment Form No. : AU_NZ_ND_IEC62368_1E			
Attachment Originator : JAS-ANZ			
Master Attachment..... : 2022-07-01			
Copyright © 2020 IEC System for Conformity Testing and Certification of Electrical Equipment (IECEE), Geneva, Switzerland. All rights reserved.			
	National Differences		P
Appendix ZZ	Variations to IEC 62368-1:2018 (ED. 3.0) for Australia and New Zealand		P
ZZ1 Scope	This Appendix lists the normative variations to IEC 62368-1:2018 (ED. 3.0)		P
ZZ2 Variations	The following modifications are required for Australian/New Zealand conditions:		P
2	After the first paragraph, <i>add</i> the following: The Australian or Australian/New Zealand Standards listed below are modified adoptions of, or not equivalent to, the IEC normative references and are required for the application of this Standard. All references in the source text to those IEC normative references shall be replaced by references to the corresponding Australian or Australian/New Zealand Standards. Australian or Australian/New Zealand Standards that are identical adoptions of international normative references may be used interchangeably -AS/NZS 3112, <i>Approval and test specification—Plugs and socket-outlets</i> -AS/NZS 3123, <i>Approval and test specification—Plugs, socket-outlets and couplers for general industrial application</i> -AS/NZS 3191, <i>Electric flexible cords</i> -AS/NZS 60884.1, <i>Plugs and socket-outlets for household and similar purposes, Part 1: General requirements</i> -IEC 60086-2 <i>Primary batteries — Part 2: Physical and electrical specifications</i> -AS/NZS 60065, <i>Audio, video and similar electronic apparatus—Safety requirements (IEC 60065:2015 (ED.8.0) MOD)</i> -AS/NZS 60320.1, <i>Appliance couplers for</i>	Appliance inlet comply with IEC/EN 60320-1	P

IEC62368_1E - ATTACHMENT			
Clause	Requirement + Test	Result - Remark	Verdict
	<p><i>household and similar general purposes, Part 1: General requirements (IEC 60320-1, Ed.2.1 (2007) MOD)</i></p> <p><i>-AS/NZS 60320.2.2, Appliance couplers for household and similar general purposes Part 2.2: Interconnection couplers for household and similar equipment (IEC 60320-2-2, Ed.2.0 (1998) MOD)</i></p> <p><i>-AS/NZS 60695.2.11, Fire hazard testing, Part 2.11: Glowing/hot wire based test methods—Glow-wire flammability test method for end-products</i></p> <p><i>-AS/NZS 60695.11.5, Fire hazard testing, Part 11.5: Test flames—Needle-flame test method—Apparatus, confirmatory test arrangement and guidance</i></p> <p><i>-AS/NZS 60695.11.10, Fire hazard testing, Part 11.10: Test flames—50 W horizontal and vertical flame test methods</i></p> <p><i>-AS/NZS 60884.1, Plugs and socket-outlets for household and similar purposes, Part 1: General requirements</i></p> <p><i>-AS/NZS 60950.1, Information technology equipment—Safety, Part 1: General requirements (IEC 60950-1, Ed.2.2 (2013), MOD)</i></p> <p><i>IEC 61032:1997, Protection of persons and equipment by enclosures—Probes for verification</i></p> <p><i>-AS/NZS 61558.1, Safety of Power Transformers, Power Supplies, Reactors and Similar Products, Part 1: General requirements and tests (IEC 61558-1 Ed 3, MOD)</i></p> <p><i>-AS/NZS 61558.2.16, Safety of transformers, reactors, power supply units and similar products for voltages up to 1 100 V, Part 2.16: Particular requirements and tests for switch mode power supply units and transformers for switch mode power supply units.</i></p>		
4.7.2	<p>Requirements</p> <p><i>Delete the text of the second paragraph and replace with the following:</i></p> <p>Equipment with a plug portion, suitable for insertion into a 10 A 3-pin flat-pin socket-outlet conforming to AS/NZS 3112, shall conform to the requirements in AS/NZS 3112 for equipment with integral pins for insertion into socket-outlets. Conformity is checked by inspection and, if necessary, by the tests in AS/NZS 3112.</p> <p>NOTE: Equipment with plug portions for use in countries other than Australia and New Zealand will need to conform to other countries' requirements</p> <p>Note Additional AS/NZS 3112 Appendix J,TRF is appended to end of this TRF.</p>	Appliance inlet used	N/A

IEC62368_1E - ATTACHMENT				
Clause	Requirement + Test	Result - Remark		Verdict
4.7.3	Compliance Criteria <i>Delete</i> this clause			N/A
4.8.1	General After second list, <i>add</i> the following: NOTE: Refer to the Consumer Goods (Products Containing Button/Coin Batteries) Safety Standard 2020 and Consumer Goods (Products Containing Button/Coin Batteries) Information Standard 2020 for more information on button cell batteries in Australia..			N/A
5.4.10.2.1	General <i>Delete</i> the first paragraph and <i>replace</i> with the following: In Australia, the separation is checked by the test given in both Clause 5.4.10.2.2 and Clause 5.4.10.2.3. In New Zealand, the separation is checked by the test given in either 5.4.10.2.2 or 5.4.10.2.3..			N/A
Table 28	<i>Delete</i> Table 28 and <i>replace</i> with the following:			N/A
Parts	Impulse test		Steady state test	
	New Zealand	Australia	New Zealand	Australia
Parts indicated in Clause 5.4.10.1 a) ^a	2.5 kV	7.0 kV for hand-held telephones and headsets, 2.5 kV for other equipment.	1.5 kV	3 kV
Parts indicated in Clause 5.4.10.1 b) and c) ^b	1.5 kV ^c		1.0 kV	1.5 kV
^a Surge suppressors shall not be removed. ^b Surge suppressors may be removed, provided that such devices pass the impulse test of Clause 5.4.10.2.2 when tested as components outside the equipment. ^c During this test, it is allowed for a surge suppressor to operate and for a sparkover to occur in a GDT.				
5.4.10.2.2	<i>Delete</i> "NOTE" and <i>replace</i> with "NOTE 1". After NOTE 1, <i>add</i> the following: NOTE 2: For Australia, the 7 kV impulse simulates lightning surges on typical rural and semi-rural network lines. NOTE 3: For Australia, the value of 2.5 kV for Clause 5.4.10.1 a) was chosen to ensure the adequacy of the insulation concerned and does not necessarily simulate likely overvoltages.			N/A
5.4.10.2.3	<i>Delete</i> "NOTE" and <i>replace</i> with "NOTE 1". After NOTE 1, <i>add</i> the following: NOTE 2: For Australia, where there are capacitors across the insulation under test, it is recommended that d.c. test voltages are used. NOTE 3: The 3 kV and 1.5 kV values for Australia have been determined considering the low frequency induced voltages from the power supply distribution system.			N/A

IEC62368_1E - ATTACHMENT			
Clause	Requirement + Test	Result - Remark	Verdict
6	Electrically-caused fire		P
6.6	After Clause 6.6, <i>add</i> the new Clauses 6.201 as follows: 6.201 External power supplies, docking stations and other similar devices (see special national conditions)		P
8.6	Stability of equipment		N/A
Table 36	Footnote ^a , after first sentence, <i>add</i> the following: Equipment having displays with moving images shall include "television sets and display devices".		N/A
8.6.1	After Clause 8.6.1 <i>add</i> the following new clauses: 8.6.201 Restraining Device fixing point (see special national conditions) 8.6.202 Restraining device (see special national conditions)		N/A
Annex F Paragraph F.3.3.4	Rated Voltage <i>Delete</i> "NOTE" and <i>replace</i> with NOTE1" After NOTE 1, <i>add</i> the following Equipment that is intended for connection to the supply mains in Australia and New Zealand shall be marked with: (a) A rated voltage of: <ul style="list-style-type: none">• 230 V for single phase equipment• 400 V for poly phase equipment Or (b) A rated voltage range that includes: <ul style="list-style-type: none">• 230 V for single phase equipment• 400 V for poly phase equipment NOTE 2: equipment that is not rated as above is not suitable for direct connection to the supply mains in Australia or new Zealand.		P
Annex F.3.3.5	After the list, <i>add</i> the following Equipment that is intended for connection to supply mains in Australia or New Zealand shall be marked with a rated frequency of 50 Hz or a rated frequency range or nominal value which includes 50Hz		N/A
Annex F.3.8	After "The DC output of an external power supply", insert "or docking stations and other similar external devices"		N/A

IEC62368_1E - ATTACHMENT			
Clause	Requirement + Test	Result - Remark	Verdict
Annex G Paragraph G.4.2	Mains connectors 1 After "IEC 60320", insert "or AS/NZS 60320 series". 2 After "IEC 60906-1", insert "or AS/NZS 3123" 3 <i>After</i> first paragraph <i>add</i> the following: 10 A or 15 A 250 V flat pin plugs for the connection of equipment to mains-powered socket-outlets for household or similar general use shall comply with AS/NZS 3112 or AS/NZS 60884.1.		N/A
Paragraph G.5.3.1	Transformers, General 1 Third dashed point <i>replace</i> 'IEC 61558-1 and the relevant parts of IEC 61558-2' with 'AS/NZS 61558-1 and the relevant parts of AS/NZS 61558.2' 2 Fourth dashed point <i>replace</i> 'IEC 61558-2-16' with 'AS/NZS 61558.2.16'.		P
Annex G.7.1	Mains supply cords, General Fourth dashed paragraph, <i>replace</i> 'IEC 60320-1' with 'AS/NZS 60320.1'		N/A
Table G.7	Sizes of conductors 1 First column, second row, <i>delete</i> "6" and <i>replace</i> with "7.5" 2 Second column, second row, <i>delete</i> '0,75' and <i>replace</i> with '0.75 ^b 3 <i>Delete</i> NOTE 1. 4 <i>Replace</i> 'NOTE 2' with 'NOTE:'. 5 <i>Delete</i> 'Footnote b' and <i>replace</i> with the following: ^b This nominal cross-sectional area is only allowed for Class II appliances if the length of the power supply cord, measured between the point where the cord, or cord guard, enters the appliance, and the entry to the plug does not exceed 2 m (0.5 mm ² three-core supply flexible cords are not permitted; see AS/NZS 3191). 6 Footnote c <i>replace</i> 'IEC 60320-1' with 'AS/NZS 60320.1' 7 Footnote d <i>replace</i> 'IEC 60320-1' with 'AS/NZS 60320.1'		N/A
Annex M M 2.1	<i>Add</i> "IEC 60086-2" to the list		N/A

IEC62368_1E - ATTACHMENT			
Clause	Requirement + Test	Result - Remark	Verdict
Annex M Paragraph M.3.2	Test method Delete "NOTE" and replace with "NOTE 1" After NOTE 1 <i>add</i> the following: NOTE 2: In cases where the voltage source is provided by power from an unassociated power source, consideration should be given to the effects of possible single fault conditions in the unassociated equipment. If the power source is unknown then it should be assumed that the maximum limit of ES1 may be applied to the source input under assumed single fault conditions in the source when assessing the charging circuit in the equipment under test.		N/A
	Special national conditions (if any)		N/A

IEC62368_1E - ATTACHMENT			
Clause	Requirement + Test	Result - Remark	Verdict
6.201	<p>External power supplies, docking stations and other similar devices</p> <p>For external power supplies, docking stations and other similar devices, during and after abnormal operating conditions and during single fault conditions the output voltage—</p> <p>(a) at all ES1 outlets or connectors shall not increase by more than 10 % of the output rated voltage under normal operating conditions, measured after 3 s of introducing a single fault condition and after 3 s of introducing abnormal operating conditions; and</p> <p>(b) of a USB outlet or connector shall not increase by more than 3 V or 10 % of the output rated voltage under normal operating conditions, whichever is higher, measured after 3 seconds of introducing a single fault condition and after 3 s of introducing abnormal operating conditions</p> <p>For equipment with multiple rated voltages at the output, the requirements apply with the equipment configured for each output rated voltage in turn</p> <p>NOTE: This is intended to reduce the possibility of battery fire or explosion in attached equipment or accessories when charging secondary lithium batteries. The 3 s measurement delay is based on IEC document 108/742/INF, <i>TC 108, Standards Interpretation Panel Question 15 — Output voltage</i>, in relation to similar requirements in IEC 62368-3:2017.</p> <p>Conformity shall be checked by measurement, taking into account the abnormal operating conditions of Annex B.3 and the simulated single fault conditions of Annex B.4.</p>		P

IEC62368_1E - ATTACHMENT			
Clause	Requirement + Test	Result - Remark	Verdict
8.6.201	<p>Restraining device fixing point Freestanding-capable MS2 and MS3 television sets and display devices shall be provided with a fixing point to facilitate the anchoring of the equipment from toppling</p> <p>The fixing point shall conform to Clause 8.7 where the fixing point uses a wall, ceiling or other structure mount. Alternatively, the fixing point shall be capable of withstanding a pull equal to the mass of the equipment in all directions without damage</p> <p>Instructions for installation or instructions for use shall be provided to specify correct use of the fixing point</p>		N/A
8.6.202	<p>Restraining device MS2 and MS3 television sets and display devices shall be provided with a restraining device and associated hardware to attach to the television set or display device.</p> <p>The restraining device shall be capable of withstanding a pull equal to the mass of the equipment in all directions.</p> <p>Instructions for installation or instructions for use shall be provided to specify correct use of the fixing point</p>		N/A

AS/NZS 3112:2017 Appendix J			
Clause	Requirement + Test	Result - Remark	Verdict

ATTACHMENT TO TEST REPORT AS_NZS_3112:2017_+A1:2021 APPENDIX J AUSTRALIAN / NEW ZEALAND NATIONAL DIFFERENCES (APPROVAL AND TEST SPECIFICATION—PLUGS AND SOCKET-OUTLETS)			
Differences according to : AS_NZS_3112:2017_Amendment 1:2021_Appendix J			
TRF template used:..... : IECEE OD-2020-F3, Ed. 1.1			
Attachment Form No. : AS_NZS_3112:2017_Appendix J			
Attachment Originator : JAS-ANZ			
Master Attachment..... : 2022-06			
Copyright © 2020 IEC System for Conformity Testing and Certification of Electrical Equipment (IECEE), Geneva, Switzerland. All rights reserved.			
Note: AS/NZS 3112 is NOT covered by IECEE Accreditation for Testing / Reporting Please State Laboratory Accreditation for this Standard			N/A
Accreditation			N/A
Accreditation Stamp			N/A

J1 SCOPE	<p>General: This Appendix specifies additional dimensional and constructional requirements for detachable plug portions, or equipment incorporating integral supply pins or equipment incorporating detachable plug portions.</p> <p>This Appendix shall be read in conjunction with Section 2 of this Standard.</p> <p>For the purposes of this Appendix, where the term 'plug' is used in Section 2 it shall be taken to mean the plug portion of equipment or the detachable plug portion.</p> <p>The equipment shall comply with the relevant product Standard. The tests and requirements specified in this Appendix are in addition to any test and requirements of the relevant product Standard for the equipment. (AS/NZS 3112:2017/A1:2021)</p>	N/A
-------------	---	-----

J2	DEFINITION	N/A
J2.1	<p>Detachable plug portion</p> <p>A plug portion that is detachable from the equipment and with connections including the following standardized outputs and other contacts</p> <p>(a) Type A (see Figure J1):</p> <p>A detachable plug portion with a connection intended for plugging directly into equipment. The connection being via the equipment group 1 appliance inlet within the scope of AS/NZS 60320.1.</p> <p>(b) Type B (see Figure J2):</p> <p>A detachable plug portion with a non-standardized connection intended for plugging directly into equipment</p>	N/A

AS/NZS 3112:2017 Appendix J			
Clause	Requirement + Test	Result - Remark	Verdict
	(c) Type C (see Figure J3): A detachable plug portion with a connection intended for use with an adaptor connected to a flexible cord so as to replicate a supply plug and flexible cord configuration. The connection being via a group 1 appliance outlet within scope of AS/NZS 60320.2.2, which is integral with the plug portion (AS/NZS 3112:2017)		
J2.2	Integral plug portion A plug portion that is integral to the equipment enclosure and is not detachable (AS/NZS 3112:2017)		N/A
J2.3	Plug portion A plug portion is that portion of equipment with pins for insertion into a socket-outlet, including the plug pins, terminals of the plug pins, external dimensions of the 'maximum projection' and any connections of a detachable plug portion. (AS/NZS 3112:2017/A1:2021)		N/A
J3	REQUIREMENTS FOR THE PLUG PORTION		N/A
J3.1	General The following provisions apply to the dimensional and constructional requirements of plug portions of equipment and any detachable connection between the plug portion and the equipment:		N/A
	(a) For detachable plug portions intended for connection to the equipment in multiple orientations, the relevant tests are performed in the most onerous orientation.		N/A
	(b) For Type A detachable plug portion, the relevant requirements of AS/NZS 3105:2014 are applicable, in addition to conformance with relevant clauses of this Appendix		N/A
	(c) For Type B detachable plug portions, the conformance is shown by the relevant clauses of this Appendix.		N/A
	(d) For Type C detachable plug portions, conformance is shown by assessment to Section 2 of this Standard (plugs) and relevant clauses of this Appendix (AS/NZS 3112:2017)		N/A
J3.2	Plug pins of plug portions The requirements of Clause 2.2 are applicable for plug pins.		N/A
2.2	PLUG PINS		N/A
2.2.1	Current carrying parts of plug pins of metal having sufficient mechanical strength, electrical conductivity and resistance to corrosion adequate for the intended use		N/A
	Plug pin material?		N/A

AS/NZS 3112:2017 Appendix J			
Clause	Requirement + Test	Result - Remark	Verdict
2.2.3	Plug pins adequately proportioned throughout and portion adjacent to the connection designed to not introduce a stress concentration which may lead to a fracture of the pin, and suitably shaped to prevent abrasion or cutting of conductor strands due to flexure in normal use		N/A
	Exposed ends of plug pins have a lead-in, bevel or radius to facilitate entry into socket-outlets and to operate shutters		N/A
	Flat-pins with the following profile are deemed to comply:		N/A
(a)	Flat-pins with a radius on the end with side bevels may have a width and thickness profile as specified in Figure 2.1(h)		N/A
(b)	Flat-pins square on the end with corner and side bevels may have a width and thickness profile as specified in Figure 2.1(i)		N/A
(c)	Flat-pins square on the end with corner bevels and a radius on the sides may have a width and thickness profile as specified in Figure 2.1(j)		N/A
	Contact portion of the pins smooth and free from openings or indentations		N/A
	Flat pin plugs having a longitudinal seam or opening in the contact portion of one face; width not exceeding 0.3 mm and		N/A
	Thickness not exceeding 1.58 mm		N/A
	Exposed portion of earthing pins and pins other than insulated pins free from any non-metallic coverings or coatings (AS/NZS 3112:2017)		N/A
2.2.4	Live parts of insulated pin plugs not exposed when plug is partially or fully engaged with associated socket		N/A
	Compliance by measurement to Figure 2.4	(see appended table)	N/A
	Lacquer, enamel or sprayed insulating coating not considered to be insulation material		N/A
	All live pins on low voltage plugs except for those shown in Figure 2.1 (a2), (b) and (g) of the insulated pin type		N/A
	Colour green or green / yellow not used for insulation of insulated pins (AS/NZS 3112:2017)		N/A
J3.3	Ratings and dimensions for low-voltage plug portions Requirements of clauses 2.8.1 and 2.8.4 apply for rating and dimensions		N/A

AS/NZS 3112:2017 Appendix J			
Clause	Requirement + Test	Result - Remark	Verdict
2.8	Ratings and Dimensions of Low Voltage Plugs		N/A
2.8.1	Plugs with ratings up to and including 20A; shall conform to the appropriate dimensions shown in Figure 2.1	(see appended results)	N/A
	Rating of plug	___A	N/A
	Nominal dimensions covering disposition of pins checked by gauge of Appendix A		N/A
	Distance between live pin and edge of moulding to not less than 9 mm		N/A
	Measured distance	___mm	N/A
	No point on plug face protrudes more than 0.5 mm		N/A
	Measured protrusion	___mm	N/A
	Dimensional requirements of Figure 2.1(e2) did not applied to plugs with greater than three pins (AS/NZS 3112:2017)		N/A
2.8.4	Low voltage plugs comply with dimensions of Figure 2.1	(see appended table 2.8.1)	N/A
	Disposition of pins checked by gauge complying with Appendix A, B or F as appropriate		N/A
	Low voltage plug having rating up to 15A and of the Figure 2.1 (a1), (c), (d), (f) or (g) type; comply with dimensional requirements of Figure 2.1 (e1 and e2)		N/A
	20A plug of Figure 2.1 (a2) type complies with dimensional requirements of Figure 2.1 (e2)		N/A
	Plugs with insulated pins need not comply with dimension $R20.0 \pm 1$ mm requirement of Figure 2.1 (e3) provided there is at least 9mm from the edge of the live pins to the edge of the plug face Figure 2.1(e3). (AS/NZS 3112:2017)		N/A
			N/A
J3.4	Internal connections for plug portions Requirements of clause 2.9 apply for internal connections, unless requirements contained in the relevant product standard (AS/NZS 3112:2017)		N/A
2.9	INTERNAL CONNECTIONS		N/A
	Plug provided with earthing connections designed and constructed so that when plug is correctly wired and assembled:		N/A
(a)	Loose terminal screw or conductive material cannot bridge any live or earthed parts		N/A
(b)	Earthing parts effectively isolated from contact with		N/A

AS/NZS 3112:2017 Appendix J			
Clause	Requirement + Test	Result - Remark	Verdict
	live conductor which may become detached		
(c)	Live parts effectively isolated from contact with any earthing conductor which may become detached		N/A
	Any connections for auxiliary devices comply with above requirements (AS/NZS 3112:2017)		N/A
J3.5	Arrangement of earthing connections for plug portions Requirements of clause 2.10 apply for arrangement of earthing connections		N/A
2.10	Arrangement of earthing connections		N/A
	Earthing pin radial to the circle embracing the pins (AS/NZS 3112:2017)		N/A
J3.6	Configuration of plug portions Requirements of clause 2.12.6 apply for configuration of the plug portion (AS/NZS 3112:2017)		N/A
2.12	Marking		N/A
2.12.6	Configuration of plugs		N/A
	Pins disposed so that configuration, as viewed from the pins, is earth, neutral and active in a clockwise direction		N/A
	Where there is no earthing pin; live pins conform to this configuration (AS/NZS 3112:2017)		N/A
J4	Tests		N/A
J4.1	General Plug portions of equipment shall be subjected to the following tests and unless stated otherwise, shall comply with the requirements specified in Section 2 for each test. The number of test samples shall be in accordance with Table J1 For equipment with a detachable plug portion, the assessment(s) of Table J1 tests 2, 3, 5, 10 and 11 shall be conducted on the— (a) assembled equipment with the detachable plug portion connected; and (b) the detachable plug portion after it has been separated from the equipment (AS/NZS 3112:2017/A1:2021)		N/A
J4.2	High voltage test The requirements of Clause 2.13.3 are applicable unless requirements are contained in the relevant product standard		N/A

AS/NZS 3112:2017 Appendix J			
Clause	Requirement + Test	Result - Remark	Verdict
	(AS/NZS 3112:2017)		
2.13.3	Test No.1 - High voltage test		N/A
	Plug withstands without failure electric strength test as specified (AS/NZS 3112:2017)	(see appended table)	N/A
J4.3	Mechanical strength		N/A
J4.3.1	Tumbling barrel test The tumbling barrel test is applied to determine the mechanical strength of the plug portions and equipment having integral or detachable plug portions. For equipment with a detachable plug portion, the detachable plug portion may become detached during the test. If this occurs the detachable plug portion shall be reassembled with the equipment when the pins are straightened as per (a) and (b) below. Three samples (Samples BCD in Table J1) that have not been subjected to any previous test are tested as specified in Clause 2.13.7.1 , however the test is modified as follows:		N/A
	They are tested in a tumbling barrel as described in AS 60068.2.32 or test Free fall repeated – Procedure 2 in IEC 60068-2.31. The samples shall be dropped from a height of 500 mm onto a steel plate, 3 mm thick. The barrel shall be turned at a rate of 5 r/min, to yield 10 falls per minute. Only one sample shall be tested at a time. A sample is dropped— (a) 500 times if the mass of the specimen does not exceed 250 g. The pins being straightened after each 100 drops and at the completion of the test to pass through the appropriate gauge of Figure A1 , Figure B1 or Figure F1 ; and (b) 250 times if the mass of the specimen exceeds 250 g. The pins being straightened after each 25 drops and at the completion of the test to pass through the appropriate gauge of Figures A1 , Figure B1 or Figure F1 . (AS/NZS 3112:2017/A1:2021)		N/A
	Mass of sample	_____ Grams	N/A
	Number of drops	500 / 250	N/A
	Compliance shall be checked by Paragraph J4.3.3	(See appended table)	N/A
J4.3.2	Test No.3 Impact test.		N/A

AS/NZS 3112:2017 Appendix J			
Clause	Requirement + Test	Result - Remark	Verdict
	<p>Plug portions and equipment having integral plug portions or detachable plug portions shall withstand lateral impact forces.</p> <p>All samples that were subjected to the tests in Paragraph J4.3.1 (Samples BCD in Table J1) shall be tested as follows:</p>		
	(a) The sample shall be positioned at the centre of a steel plate with a thickness of at least 6 mm. Apertures in the steel plate for the plug pins to pass through shall conform to the corresponding socket Standard. The sample shall be held against the steel plate by clamping all the pins.		N/A
	(b) Samples shall be subjected to blows, with an impact energy of 1.0 ± 0.05 J by any means having the same performance as the spring-operated impact-test apparatus of AS/NZS 3100.		N/A
	(c) Three blows shall be applied to every point that is most likely to directly or indirectly stress the enclosure joints of the sample		N/A
	Compliance shall be checked by Paragraph J4.3.3		N/A
J4.3.3	<p>Specific compliance criteria</p> <p>This Paragraph provides the common compliance assessment criteria for tests specified in Paragraphs J4.3.1 and J4.3.2.</p>		N/A
	Following each test, the samples shall comply with Clause 2.13.7.1		N/A
(a)	assembled equipment with the detachable plug portion connected;		N/A
	After the test, samples show no damage	(See appended table)	N/A
(b)	the detachable plug portion after it has been separated from the equipment.		N/A
	After the test, samples show no damage	(See appended table)	N/A
4.3.4	<p>Pin bending test</p> <p>The pins of the plug portion of three samples (Samples EFG in Table J1) not subjected to any previous tests shall be tested for compliance with the pin bending test of Clause 2.13.7.2</p> <p>(AS/NZS 3112:2017/A1:2021)</p>		N/A
2.13.7.2	Test No.4 – Pin bending test		N/A
	All flat-pin plugs rated up to and including 15 A shall be subjected to the pin bending test		N/A
	Three samples are subjected by clamping the plug in a rigid holding block and applying the bending force as specified		N/A
	After the test the pins shall not be broken off.		N/A

AS/NZS 3112:2017 Appendix J			
Clause	Requirement + Test	Result - Remark	Verdict
	(AS/NZS 3112:2017)		
J4.8.3	Test No.5 Plug portion detachment requirements		N/A
	For all Type B or C devices and for Type A devices where the outlet of the detachable plug portion is parallel to the plug supply pins, disengagement of the detachable plug portion from the equipment shall require at least two simultaneous independent actions or the use of a tool.		N/A
	The plug portion and the equipment/adaptor shall be connected and disconnected 50 times (100 strokes).		N/A
	Compliance is verified by the plugging test, a force which, over a period of 10 s, shall be increased steadily to 60 ±0.6 N and held at this value for a further 10 s, shall be applied evenly at the connecting equipment in a direction parallel to the pins. This procedure shall be conducted three times on the same plug portion, at intervals of 5 min, without disturbing the plug portions between tests		N/A
	During the test the plug portion shall not separate		N/A
	The test of AS/NZS 3112 'temperature rise test' for plugs shall be conducted immediately after the above test without disturbing the sample. Test No 6 Temperature Rise test J4.4 (AS/NZS 3112:2017/A1:2021)		N/A
J4.4	Temperature rise test		N/A
	The relevant requirements of Clause 2.13.8 are applicable for the temperature rise test, except that the test current shall be that specified in the relevant product standard		
	The temperature rise of the pins shall not exceed 45 K irrespective of the temperature rise of parts specified in end-product standards.		N/A
	For detachable plug portions the temperature rise of terminals and contacts shall not exceed 45 K. (AS/NZS 3112:2017)		N/A
2.13.8	Test No.6 – Temperature rise test		N/A
	Plug tested in draught free environment as specified using clamping units as specified in Figure 2.10		N/A
	Test Current Relevant Product Standard	_____ Amps _____ (Standard?)	N/A
	Temperature of terminals and contacts of detachable plug portion not exceeding 45 K	(see appended table)	N/A

AS/NZS 3112:2017 Appendix J			
Clause	Requirement + Test	Result - Remark	Verdict
	(AS/NZS 3112:2017)		
J4.5	<p>Securement of pins of the plug portion</p> <p>The requirements of Clause 2.13.9 are applicable for the securement of pins.</p> <p>(AS/NZS 3112:2017)</p>		N/A
2.13.9	Test No.7. Securement of pins		N/A
2.13.9.1	Movement of pins		N/A
	Plug pins clamped 5 ± 0.5 mm from pin face; test equipment and sample pre-conditioning for 1 h at $40 \pm 1^\circ\text{C}$		N/A
	Force of 18 ± 1 N applied to pin 14 ± 0.5 mm from plug face; applied gradually over 10 s and maintained for 10 s; applied in four directions		N/A
	Maximum deflection during test not exceeding 2.0 mm	(see appended results)	N/A
	Any distortion 5 minutes after test does not prevent insertion of plug into standard gauge(s)		N/A
	(AS/NZS 3112:2017 + A1:2021)		
2.13.9.2	Fixing of pins		N/A
	Plug heated to $50 \pm 2^\circ\text{C}$ for 1h		N/A
	Force of 60 ± 0.6 N applied to each pin over 10 s and maintained for 10 minutes; applied in two directions along length of pin		N/A
	Maximum displacement during test not exceeding 2.4 mm		N/A
	Maximum measured displacement		N/A
	Pin returns to within 0.8 mm of nominal length within 5 minutes of removal of test force		N/A
	(AS/NZS 3112:2017)		
J4.6	<p>Tests on the insulation material of insulated pin-plug portions</p> <p>The requirements of Clause 2.13.13 are applicable for insulating material of insulated plug pins.</p> <p>(AS/NZS 3112:2017)</p>		N/A
2.13.13	Test No.8 Tests for insulation material of insulated pin plugs		N/A
2.13.13.1	Material of pin-insulation resistant to stresses at temperature likely to occur		N/A
2.13.13.2	Pressure test at high temperature		N/A
	Specimen tested as per Figure 2.5 with force of 2.5 N applied as specified; maintained for 2 h at		N/A

AS/NZS 3112:2017 Appendix J			
Clause	Requirement + Test	Result - Remark	Verdict
	160 ± 5°C; removed and cooled by immersion in water within 10 s		
	Thickness of insulation at point of impression not reduced by more than 50%		N/A
	Initial thickness	mm	N/A
	Thickness after test	mm	N/A
	No visible cracks on insulation material		N/A
	Dimension of insulating material not below minimum size in Figure 2.4 (AS/NZS 3112:2017)		N/A

2.13.13.3	Static damp heat test		N/A
	Specimen subjected to two damp heat cycles in accordance with IEC 60068-2-30; Db (12 + 12h), 95% RH, 25 ± 3°C; 40°C		N/A
	After this treatment and recovery to room temperature; specimen subjected to:		N/A
(a)	Insulation resistance test in accordance with clause 2.13.2 (e)	(see appended table)	N/A
(b)	High voltage test in accordance with clause 2.13.3	(see appended table)	N/A
(c)	Abrasion test in accordance with clause 2.13.13.6		N/A
2.13.13.4	Low temperature test		N/A
	Plug maintained at -15 ± 2°C for minimum of 24 h and returned to room temperature; after which specimen subjected to:		N/A
(a)	Insulation resistance test in accordance with clause 2.13.2 (e)	(see appended table)	N/A
(b)	High voltage test in accordance with clause 2.13.3	(see appended table)	N/A
(c)	Abrasion test in accordance with clause 2.13.13.6		N/A
2.13.13.5	Impact test at low temperature		N/A
	Specimen maintained at -15 ± 2°C for 24 h		N/A
	Specimen placed in position and subjected to impact test as per Figure 2.6; mass of 100 ± 1 g falling through 100 mm		N/A
	Four impacts applied; specimen rotated through 90° between impacts		N/A
	After return to room temperature; no visible cracks of insulating material		N/A
2.13.13.6	Abrasion test		N/A
	Plug held in clamp and tested as per Figure 2.7; pin loaded at 4 N; 20 000 movements		N/A
	After test; pins show no damage affecting safety or impairing further use of the plug		N/A

AS/NZS 3112:2017 Appendix J			
Clause	Requirement + Test	Result - Remark	Verdict
	Insulating sleeve not punctured or rucked up (AS/NZS 3112:2017)		N/A
J4.7	Test no.9 Equipment with a plug portion intended to be supported by the contacts of a socket-outlet		N/A
	Equipment with pins intended to be introduced into fixed socket-outlets not imposing undue strain on socket-outlet		N/A
	Applied torque not exceeding 0.25 Nm		N/A
	Measured torque (AS/NZS 3112:2017)	_____Nm	N/A
J4.8	Additional requirements for detachable plug portions		N/A
J4.8.1	Test no.10 Access to live parts		N/A
	Small test finger of Figure 13 of IEC 61032 was not possible to contact live parts with the force of 20N		N/A
	incorrectly assemble the plug portion was not possible (AS/NZS 3112:2017)		N/A
J4.8.2	Test No.11 Construction of detachable contacts where the input current of the equipment exceeds 0.2 A		N/A
	Contacts of the equipment shall be such that they make and maintain, under normal service conditions, satisfactory electrical and mechanical contact with the corresponding contact of the detachable plug portion.		N/A
	For connections intended to accommodate pins, contact shall be made on two surfaces diametrically opposite, except if a single spring-assisted contact is used. (AS/NZS 3112:2017/A1:2021)		N/A
	Contacts shall not rely exclusively on the resilience of the contact material and shall have an opposite face of material other than thermoplastic or resilient insulating material. (AS/NZS 3112:2017/ A1:2021)		N/A
	The alignment and contact-making properties of contacts shall be independent of terminal screws		N/A
	The effectiveness of the contacts shall be independent of pressure from any thermoplastic or resilient moulding.		N/A
	A visual inspection is conducted to determine the existence of interference between the metal contacts and the thermoplastic or resilient moulding to provide supplementary contact pressure to the metal contacts.		N/A
	Conformance of the effectiveness of the contacts is checked by inspection and by the inspection and tests in J4.8.3		N/A

AS/NZS 3112:2017 Appendix J			
Clause	Requirement + Test	Result - Remark	Verdict
	(AS/NZS 3112:2017)		
J4.8.4	Resistance of insulating material to heat and fire		N/A
J4.8.4.1	Test no.12 Resistance to heat For Type B detachable plug portions parts of non-metallic material, parts of insulating material supporting live parts including connections, and parts of thermoplastic material providing supplementary insulation or reinforced insulation, shall be sufficiently resistant to heat if their deterioration could cause the appliance to fail to comply with this Standard.		N/A
	Ball pressure test conducted in accordance with IEC 60695-10-2		N/A
(a)	75°C ± 2°C, for external parts;		N/A
(b)	125°C ± 2°C, for parts supporting live parts.		N/A
J4.8.4.2	Test no.13 Resistance to fire		N/A
	Plug portions comply with resistance to fire requirements of AS/NZS 3100 Annex A as follows:		N/A
	The glow wire test temperature 'T' for 'retaining parts' of fixed socket outlets shall be 750 C (AS/NZS 3112:2017)		N/A

TABLES OF RESULTS

2.2.4	TABLE: Dimensions of insulation on insulated pin plugs		N/A
	Dimension (Figure 2.1 designation)	Measured (mm)	Allowed (mm)
	Phase pin		8.7 ± 0.5
	Neutral pin		8.7 ± 0.5

2.8.1	TABLE: Dimensions of plugs- 10A (a1)		N/A
	Dimension (Figure 2.1 designation)	Measured (mm)	Allowed (mm)
	Phase and neutral pin width (A)		6.35 ± 0.15
	Earth pin width (B)		6.35 ± 0.15
	Pin thickness (C)		1.63 + 0.15, -0.05
	Pin disposition (D)		checked by test gauge
	Pin disposition (E)		checked by test gauge
	Phase and neutral pin length (F)		17.06 ± 0.4
	Earth pin length (G)		19.94 ± 0.8
	Pin boss radius - maximum		21.0 max
	Pin boss height		8.6 min

AS/NZS 3112:2017 Appendix J			
Clause	Requirement + Test	Result - Remark	Verdict
2.8.1	TABLE: Dimensions of plugs- 15A (a1)		N/A
Dimension (Figure 2.1 designation)		Measured (mm)	Allowed (mm)
Phase and neutral pin width (A)			6.35 ± 0.15
Earth pin width (B)			9.08 ± 0.15
Pin thickness (C)			1.63 + 0.15, -0.05
Pin disposition (D)			checked by test gauge
Pin disposition (E)			checked by test gauge
Phase and neutral pin length (F)			17.06 ± 0.4
Earth pin length (G)			19.94 ± 0.8
Pin boss radius - maximum			21.0 max
Pin boss height			8.6 min
2.8.1	TABLE: Dimensions of plugs-20A (a2)		N/A
Dimension (Figure 2.1 designation)		Measured (mm)	Allowed (mm)
Phase and neutral pin width (A)			9.08 ± 0.15
Earth pin width (B)			9.08 ± 0.15
Pin thickness (C)			1.63 + 0.15, -0.05
Pin disposition (D)			checked by test gauge
Pin disposition (E)			checked by test gauge
Phase and neutral pin length (F)			17.06 ± 0.4
Earth pin length (G)			19.94 ± 0.8
Pin boss radius - maximum			21.0 max
Pin boss height			8.6 min
2.8.1	TABLE: Projection from plug face centroid		N/A
Direction of projection		Measured (mm)	Allowed (mm)
Left			≤ 21.9 or ≥ 27.0
Right			≤ 21.9 or ≥ 27.0
Up			≤ 21.9 or ≥ 27.0
Down			≤ 21.9 or ≥ 27.0
2.13.3	TABLE: Test No. 1 – High voltage test		N/A
Test voltage applied between:		Test voltage (V)	Breakdown
All poles of the plug; taken in pairs		1000	Yes / No
Live poles of the plug and any external metal		3500	Yes / No
Live poles of the plug and the earthing terminal		1000	Yes / No

AS/NZS 3112:2017 Appendix J			
Clause	Requirement + Test	Result - Remark	Verdict
	Live poles of the plug and a flexible electrode	3500	Yes / No
	Live poles and metal foil applied around insulation on pins	1250	Yes / No

2.13.7.1	Test No.2 – Tumbling barrel test		N/A
	Following the test, the samples shall comply with Clause 2.13.7.1(a..e)		N/A
	(a) Live parts shall not have become exposed to the standard test finger		N/A
	(b) For earth pins, the resistance of the plug/socket-outlet circuit shall be such that conformance with Clause 3.14.7 is maintained. AS/NZS 3100 Cl 8.5 The resistance shall not exceed 0.1 Ω	___ Ω .	N/A
	(c) Any other function affecting safety shall not be impaired		N/A
	(d) No live part shall have become detached or loosened, to the extent that a hazardous situation is created (see Clause 2.9)		N/A
	(e) The pins shall be inspected with normal, or corrected to normal, vision. Insulation may be removed if necessary. Pins shall not be broken or show cracking		N/A

	Test No.3 Impact test for assembled equipment with the detachable plug portion connected and for equipment with an integral plug portion.		N/A
	Following the test, the samples shall comply with Clause 2.13.7.1 (a..e) as follows:		N/A
	(a) Live parts shall not have become exposed to the standard test finger (Figure 8.10 in AS/NZS 3100 or Test Probe B in IEC 61032)		N/A
	(b) For earth pins, the resistance of the plug/socket-outlet circuit shall be such that conformance with Clause 3.14.7 is maintained so that the resistance between the earthing terminal of any socket-outlet provided with an earthing contact and the earthing terminal of the plug used for testing shall be of a low resistance. Compliance is by the test of earthing connection in AS/NZS 3100 Clause 8.5. The resistance shall not exceed 0.1 Ω	___ Ω .	N/A

AS/NZS 3112:2017 Appendix J			
Clause	Requirement + Test	Result - Remark	Verdict
	(c) Any other function affecting safety shall not be impaired		N/A
	(d) No live part shall have become detached or loosened, to the extent that a hazardous situation is created		N/A
	(e) The pins shall be inspected with normal, or corrected to normal, vision. Insulation may be removed if necessary. Pins shall not be broken or show cracking.		N/A
	Following the test, the samples shall conform to the 'Guarding of live parts' requirements of AS/NZS 3100:2015 cl 5.1 as follows:		N/A
	Except for equipment intended for use only in a position not accessible to unauthorized persons, all equipment shall be so designed and constructed that, when the equipment is standing, supported, or fixed, in a normal manner, no person can inadvertently come into contact with any live part		N/A
	If a hole giving access to preset controls is marked as such on the enclosure or reference made to it in the instructions and the setting of this control requires a screwdriver or other tool, the adjustment of the control shall not allow contact with any live parts. A metal test pin having a diameter of 2 mm and a length of 100 mm shall not become live when it is inserted through the hole in every position with a force of 10 N.		N/A
	In addition, the opening or removal of any cover or component, with or without tools, where such opening or removal is necessary as a normal operation of the equipment as distinct from maintenance, repairs, or adjustment, shall not expose live parts to inadvertent personal contact.		N/A
	Any metal cover or casing enclosing live parts shall be of a strength sufficient to ensure that it cannot be deformed readily so as to come into contact with live parts.		N/A
	Compliance is checked by inspection, test and checking that live parts shall not have become exposed to the standard test finger (Figure 8.10 in AS/NZS 3100 or Test Probe B in IEC 61032)		N/A
	Class II equipment and class II constructions shall be constructed and enclosed so that there is adequate protection against accidental contact with basic insulation and metal parts separated from live parts by basic insulation only.		N/A
	It shall only be possible to touch parts which are separated from live parts by double insulation or reinforced insulation.		N/A
	Compliance is checked by application of the standard test finger (Figure 8.10 in AS/NZS 3100 or Test Probe B in IEC 61032)		N/A

AS/NZS 3112:2017 Appendix J			
Clause	Requirement + Test	Result - Remark	Verdict
	Following the test, the samples shall conform to the 'Separation of live parts from non-current-carrying conductive parts' requirements of AS/NZS 3100.Cl 5.2.2 as follows:		N/A
	The support and insulation of every live part shall be such as will ensure that no live part can make contact with any non-current-carrying conductive part exposed to personal contact.		N/A
	In respect of terminals of components such as switches, adequate clearances shall be maintained or insulation shall be provided to prevent contact of the terminals, or loose strands of flexible cords intended to be terminated therein, with exposed conductive parts. Where necessary, provision shall be made to ensure that conductors protruding through terminals, when normally connected, will not contact exposed conductive parts.		N/A
	Compliance is checked by inspection.		N/A

	Test No.3 Impact test for the detachable plug portion after it has been separated from the equipment		N/A
	Following the test, the samples shall comply with Clause 2.13.7.1 (a..e)		N/A
	(a) Live parts shall not have become exposed to the standard test finger (Figure 8.10 in AS/NZS 3100 or Test Probe B in IEC 61032)		N/A
	(b) For earth pins, the resistance of the plug/socket-outlet circuit shall be such that conformance with Clause 3.14.7 is maintained so that the resistance between the earthing terminal of any socket-outlet provided with an earthing contact and the earthing terminal of the plug used for testing shall be of a low resistance. Compliance is by the test of earthing connection in AS/NZS 3100 Clause 8.5. The resistance shall not exceed 0.1 Ω	___ Ω .	N/A
	(c) Any other function affecting safety shall not be impaired		N/A
	(d) No live part shall have become detached or loosened, to the extent that a hazardous situation is created		N/A
	(e) The pins shall be inspected with normal, or corrected to normal, vision. Insulation may be removed if necessary. Pins shall not be broken or show cracking.		N/A

AS/NZS 3112:2017 Appendix J			
Clause	Requirement + Test	Result - Remark	Verdict
	Following the test, the samples shall conform to the 'Guarding of live parts' requirements of AS/NZS 3100:2015 cl 5.1 as follows:		N/A
	Except for equipment intended for use only in a position not accessible to unauthorized persons, all equipment shall be so designed and constructed that, when the equipment is standing, supported, or fixed, in a normal manner, no person can inadvertently come into contact with any live part		N/A
	If a hole giving access to preset controls is marked as such on the enclosure or reference made to it in the instructions and the setting of this control requires a screwdriver or other tool, the adjustment of the control shall not allow contact with any live parts. A metal test pin having a diameter of 2 mm and a length of 100 mm shall not become live when it is inserted through the hole in every position with a force of 10 N.		N/A
	In addition, the opening or removal of any cover or component, with or without tools, where such opening or removal is necessary as a normal operation of the equipment as distinct from maintenance, repairs, or adjustment, shall not expose live parts to inadvertent personal contact.		N/A
	Any metal cover or casing enclosing live parts shall be of a strength sufficient to ensure that it cannot be deformed readily so as to come into contact with live parts.		N/A
	Compliance is checked by inspection, test and checking that live parts shall not have become exposed to the standard test finger (Figure 8.10 in AS/NZS 3100 or Test Probe B in IEC 61032)		N/A
	Class II equipment and class II constructions shall be constructed and enclosed so that there is adequate protection against accidental contact with basic insulation and metal parts separated from live parts by basic insulation only.		N/A
	It shall only be possible to touch parts which are separated from live parts by double insulation or reinforced insulation.		N/A
	Compliance is checked by application of the standard test finger (Figure 8.10 in AS/NZS 3100 or Test Probe B in IEC 61032)		N/A
	Following the test, the samples shall conform to the 'Separation of live parts from non-current-carrying conductive parts' requirements of AS/NZS 3100.CI 5.2.2 as follows:		N/A
	The support and insulation of every live part shall be such as will ensure that no live part can make contact with any non-current-carrying conductive part exposed to personal contact.		N/A

AS/NZS 3112:2017 Appendix J			
Clause	Requirement + Test	Result - Remark	Verdict
	In respect of terminals of components such as switches, adequate clearances shall be maintained or insulation shall be provided to prevent contact of the terminals, or loose strands of flexible cords intended to be terminated therein, with exposed conductive parts. Where necessary, provision shall be made to ensure that conductors protruding through terminals, when normally connected, will not contact exposed conductive parts.		N/A
	Compliance is checked by inspection.		N/A
2.13.8	TABLE: Test No. 6 - Temperature rise test		N/A
	Ambient temperature	°C	
	Test current	A	
	Measured part	dT measured (K)	dT allowed (K)
	Active (phase) terminal		45
	Neutral terminal		45
	Earthing terminal		45
2.13.9.1	TABLE: Movement of pins		N/A
	Earth and neutral pins clamped – phase pin loaded		
	Force direction	Measured deflection (mm)	Allowed deflection (mm)
	Force towards neutral plane parallel to pin plane		2.0
	Force from neutral plane parallel to pin plane		2.0
	Force outwards at 90° to pin plane		2.0
	Force inwards at 90° to pin plane		2.0
2.13.9.1	TABLE: Movement of pins		N/A
	Phase and neutral pins clamped – earth pin loaded		
	Force direction	Measured deflection (mm)	Allowed deflection (mm)
	Force inwards parallel to pin plane		2.0
	Force outwards parallel to pin plane		2.0
	Force towards neutral		2.0
	Force towards phase		2.0
2.13.9.1	TABLE: Movement of pins		N/A
	Phase and earth pins clamped – neutral pin loaded		

AS/NZS 3112:2017 Appendix J			
Clause	Requirement + Test	Result - Remark	Verdict
Force direction		Measured deflection (mm)	Allowed deflection (mm)
Force towards phase plane parallel to pin plane			2.0
Force from phase plane parallel to pin plane			2.0
Force outwards at 90° to pin plane			2.0
Force inwards at 90° to pin plane			2.0
2.13.13.3	TABLE: Test No.13(b) – Insulation resistance test after static damp heat test		N/A
Applied between:		Insulation resistance (MΩ)	Minimum required (MΩ)
Live poles and metal foil applied around insulation on pins			5
2.13.13.3	TABLE: Test No.1 – High voltage test after static damp heat test		N/A
Test voltage applied between:		Test voltage (V)	Breakdown
Live poles and metal foil applied around insulation on pins		1250	Yes / No
2.13.13.4	TABLE: Test No.1 – Insulation resistance test after low temperature test		N/A
Applied between:		Insulation resistance (MΩ)	Minimum required (MΩ)
Live poles and metal foil applied around insulation on pins			5
2.13.13.4	TABLE: Test No.1 – High voltage test after low temperature test		N/A
Test voltage applied between:		Test voltage (V)	Breakdown
Live poles and metal foil applied around insulation on pins		1250	Yes / No
J4.8.4.1	TABLE: Test no.12 Resistance to heat		N/A
Component tested		Temperature (°C)	Diameter of impression (mm)

Conformance is checked by subjecting the relevant part to the ball pressure test of IEC 60695-10-2.

J4.8.4.2	TABLE: Test no.13 Resistance to Fire		N/A
	Plug portions shall comply with the requirements for resistance to fire in accordance with AS/NZS 3100:2017 Annex A. The glow-wire test temperature 'T' shall be 750°C.		

Glow-wire testing was conducted in accordance with IEC 60695-2-11.

Test specimens arranged so that the surface in contact with the tip of the glow-wire was vertical and

AS/NZS 3112:2017 Appendix J			
Clause	Requirement + Test	Result - Remark	Verdict

glow wire tip applied to surface of the specimen likely to be subjected to thermal stresses in normal use.

A layer of white pine board and wrapping tissue was placed beneath the sample at 200mm ± 5mm distance.

AS/NZS 3112:2017 Appendix J			
Clause	Requirement + Test	Result - Remark	Verdict

SPECIMEN NUMBER	1	2	3	4	5	6	7	8
SPECIMEN DESCRIPTION								
Material								
Colour								
Test specimen								
Glow wire tip temperature (°C)	750	750	750	750	750	750	750	750
Duration of glow wire application (t _a) (s)	30	30	30	30	30	30	30	30
OBSERVATIONS								
Duration from beginning of glow-wire tip application to ignition of specimen or layer (t _i) (s)								
Duration from beginning of glow-wire tip application to when flames extinguish (t _e) (s)								
Maximum height of flames after initial 1s (to nearest 5 mm) (mm)								
Flame impingement on other parts								
Degree of tip penetration								
Degree of specimen distortion								
Scorching of pinewood board								
EVALUATION CRITERIA								

AS/NZS 3112:2017 Appendix J			
Clause	Requirement + Test	Result - Remark	Verdict

Visible flame or sustained glowing								
Visible Flame Duration in Seconds during test.								
Duration of flaming or glowing after tip removal (max. allowable 30 s) (s)								
Surrounding parts burned away completely (not permitted)								
Ignition of wrapping tissue layer (not permitted)								
RESULTS If parts tested withstand the glow-wire test, but during the test produce a flame that persists for longer than 2 s, then the consequential needle flame test of AS/NZS 3100:2017 Annex A 6.1.5 applies.								

LEGEND: CE Complete Equipment SA Sub Assembly SE Self Extinguished
 EBD Emitted Burning Droplets SBD Specimen Burned and Distorted SMD Specimen Melted and Distorted
 ME Manually Extinguished SC Separate Component SS Specimen Scorched
 NA Not Applicable SCC Specimen Completely Consumed WPNI Wall Penetrated but no Ignition
 NI No Ignition X Flame Appeared for an Instant

AS/NZS 3112:2017 Appendix J

Clause	Requirement + Test	Result - Remark	Verdict
--------	--------------------	-----------------	---------

TABLE: Needle- flame test (NFT)					N/A
Object/ Part No./ Material	Manufacturer/ trademark	Duration of application of test flame (ta); (s)	Ignition of specified layer Yes/No	Duration of burning (tb) (s)	Verdict

Supplementary information:

- NFT not relevant (or applicable) for Parts of material classified as V-0 or V-1
- NFT not relevant (or applicable) for Base material of PCBs classified as V-0 or if relevant VTM-0

ATTACHMENT to TRF IEC62368_1E			
Clause	Requirement + Test	Result - Remark	Verdict

Appendix No.5: National differences for Japan

ATTACHMENT TO TEST REPORT IEC 62368-1:2018 JAPAN NATIONAL DIFFERENCES AUDIO/VIDEO, INFORMATION AND COMMUNICATION TECHNOLOGY EQUIPMENT – PART 1: SAFETY REQUIREMENTS			
Differences according to : J62368-1(2023)			
TRF template used: : IECEE OD-2020-F3:2022, Ed. 1.2			
Attachment Form No. : JP_ND_IEC62368_1E			
Attachment Originator : UL Solutions (JP)			
Master Attachment : Dated 2023-05-12			
Copyright © 2023 IEC System for Conformity Testing and Certification of Electrical Equipment (IECEE), Geneva, Switzerland. All rights reserved.			
National Differences			
4.1.2	Where the component, or a characteristic of a component, is a safeguard or a part of a safeguard, components shall comply with the requirements of this document or, where specified in a requirements clause, with the safety aspects of the relevant JIS component standards or IEC component standards, or components shall have properties equivalent to or better than these.		P
5.6.1	Mains socket-outlet and interconnection coupler shall comply with Clause G.4.2A if they are incorporated as part of the equipment.		N/A

ATTACHMENT to TRF IEC62368_1E			
Clause	Requirement + Test	Result - Remark	Verdict
5.6.2.1	<p>Connection for protective conductor of class 0I equipment provided with instructional safeguard in accordance with Clause F.3.6.1A is considered to make earlier and break later than supply connection.</p> <p>Mains plug having a lead wire for protective earthing connection of class 0I equipment shall comply with all of the following:</p> <ul style="list-style-type: none"> – Not to be used for equipment having a rated voltage of 150 V or more – Clip is not used for the earthing connection of the lead wire. – The lead wire for earthing is at least 10 cm long <p>If class 0I equipment provides an independent main protective earthing terminal and is intended to be installed by ordinary person, earthing wire shall be provided in the package of the equipment.</p>		P
5.6.2.2	Internal earthing conductor of the cord set that is covered by the sheath of mains cord and is formed together with mains plug and appliance connector need not be green-and-yellow.		N/A
5.6.3	<p>In case of class 0I equipment using power supply cord having two conductors (no earthing conductor), the conductor of protective earthing lead wire shall comply with either of the following:</p> <ul style="list-style-type: none"> – use of annealed copper wire with 1.6 mm diameter or corrosion-inhibiting metal wire having size and strength that are equivalent to or more than the above copper wire – single core cord or single core cable with 1.25 mm² or more cross-sectional area 		N/A
5.7.3	For class 0I equipment that is provided with mains socket-outlet in the configuration as specified in JIS C 8282 series, JIS C 8300 or JIS C 8303, or that is provided with mains appliance outlet as specified in JIS C 8283 series for the purpose of interconnection, the measurement is conducted on the system of the interconnected equipment having a single connection to the mains.		N/A
5.7.5	In case of class 0I equipment, touch current shall not exceed 1.41 mA peak or for sinusoidal wave, 1.0 mA r.m.s. when measured using the network specified in Figure 4 of IEC 60990:2016.		P

ATTACHMENT to TRF IEC62368_1E			
Clause	Requirement + Test	Result - Remark	Verdict
6.4.3.2	<p>A fuse complying with JIS C 6575 series or a fuse having equivalent characteristics shall open within 1 s.</p> <p>A fuse having time/current characteristics other than those specified in IEC 60127 shall be tested with the characteristics taken into account. In case of Class A fuse of JIS C 6575, replace "2.1 times" by "1.35 times" and in case of Class B fuse of JIS C 6575, replace "2.1 times" by "1.6 times".</p>		P
8.5.4.3.1	Only three-phase stationary equipment rated more than AC 200 V can be considered as being for use in locations where children are not likely to be present, when complying with Clause F.4.		N/A
8.5.4.3.2	For equipment installed where children may be present, an instructional safeguard shall be provided by easily understandable wording in accordance with Clause F.5, except that element 3 is optional.		N/A
8.5.4.3.4	The media destruction device is tested according to Clause V.1.2 with applicable jointed test probes to the opening. And then the wedge probe per Figure V.4 shall not contact any moving part.		N/A
8.5.4.3.5	<p>The wedge probe of Figure V.4 and applicable jointed test probes specified in Clause V.1.2 shall not contact any moving part.</p> <p>Instructional safeguard shall not be used instead of equipment safeguard for preventing access to hazardous moving parts.</p>		N/A
F.3.5.1	<p>When the mains socket-outlet is configured in accordance with JIS C 8282 series, JIS C 8300 or JIS C 8303, the assigned current or power shall be marked. If the voltage of the socket-outlet is the same as the mains voltage, the voltage need not be marked.</p> <p>Instructional safeguard of Class 0I equipment shall be provided with an instructional safeguard in accordance with Clause F.5 when a mains socket-outlet as specified in JIS C 8282 series, JIS C 8300 or JIS C 8303 to which class I equipment can be connected is provided in accordance with Clause G.4.2A except for the cases where the socket-outlet is accessible only to skilled persons.</p>		N/A
F.3.5.3	If the fuse is necessary for the safeguard function, the symbols indicating pre-arcing time-current characteristic shall be included.		N/A

ATTACHMENT to TRF IEC62368_1E			
Clause	Requirement + Test	Result - Remark	Verdict
F.3.6.1A	<p>Marking for class 0I equipment</p> <p>The requirements of Clauses F.3.6.1.1 and F.3.6.1.2 shall be applied to class 0I equipment.</p> <p>For class 0I equipment, a marking of instructions shall be provided regarding the earthing connection.</p> <p>In addition to the above, for class 0I equipment, an instruction to connect earthing before and disconnect earthing after the connection of supply conductors shall be marked on the visible place of the main body or shall be in the text of an accompanying document.</p>		P
F.3.6.2	Symbols, IEC 60417-5172 (2003-02) or IEC 60417-6092 (2011-10), shall not be used for class I equipment or class 0I equipment.		P
F.3.8A	<p>Attention marking for aging deterioration of CRT television</p> <p>Year of manufacture, standard usage period by design according to JIS C 9921-5 and cautionary statement for possible risks of aging deterioration when used beyond the specified period shall be marked on CRT television except for industrial use CRT television.</p>		N/A
F.4	<p>For audio equipment with terminals classified as ES3 in accordance with Table E.1, and for other equipment with terminals marked in accordance with F.3.6.1 and F.3.6.1A, the instructions shall require that the external wiring connected to these terminals shall be installed by a skilled person, or shall be connected by means of ready-made leads or cords that are constructed in a way that would prevent contact with any ES3 circuit.</p> <p>For class 0I equipment provided with independent main protective earthing terminal, where the cord for the protective earthing connection is not provided in the package of the equipment, if the protective earthing connection is made by instructed person or skilled person, the suitable installation instruction for the protective earthing connection shall be provided.</p>		N/A
G.3.2.1	The thermal link when tested as a separate component, shall comply with the requirements of JIS C 6691 or have properties equivalent to or better than that.		N/A

ATTACHMENT to TRF IEC62368_1E			
Clause	Requirement + Test	Result - Remark	Verdict
G.3.4	<p>Except for devices covered by Clause G.3.5, overcurrent protective devices used as a safeguard shall comply with the applicable JIS or IEC standard in accordance with 4.1.2 or shall have equivalent or better properties.</p> <p>Such a protective device shall have adequate breaking (rupturing) capacity to interrupt the maximum fault current (including short-circuit current) that can flow.</p>		P
G.4.1	This requirement does not apply to connectors covered in Clauses G.4.2 and G.4.2A.		N/A
G.4.2	<p>Mains connectors, mains plugs and socket-outlets shall comply with JIS C 8283 series, JIS C 8285, IEC 60309 series, JIS C 8282 series, JIS C 8300, JIS C 8303, or have equivalent or better properties.</p> <p>A power supply cord set provided with appliance connector that can fit appliance inlet complying with JIS C 8283-1 shall comply with JIS C 8286.</p> <p>Construction shall prevent mechanical stress not to transmit to the soldering part of appliance inlet terminal.</p> <p>When an equipment is rated not more than 125 V and all of the following are met, Type C14 and C18 appliance inlet complying with JIS C 8283-3 can be considered as rated 15 A.</p> <ul style="list-style-type: none"> – The temperature of appliance inlet does not exceed the value specified in JIS C 8283-1 under the most unfavourable normal operating condition as specified in Clause B.2.1. – "Use only designated cord set attached in this equipment" or equivalent text is described in the operating instruction. If the cord set is not provided in the package of the equipment, suitable information regarding to the cord set is described in the operating instruction. 		P
G.4.2A	Mains socket-outlet and interconnection coupler provided with the class II, class I and class 0I equipment respectively		N/A
G.7.1	A mains supply cord need not include the protective earthing conductor for class 0I equipment provided with independent protective earthing conductor.		N/A

ATTACHMENT to TRF IEC62368_1E			
Clause	Requirement + Test	Result - Remark	Verdict
G.7.2 Table G.7	Cross-sectional area of equipment rated up to and including 3 A shall be 0.75 mm ² .		N/A
G.7.6.1 Table G.9	<p>The cross-sectional area of mains cords according to JIS C 3010 may comply with relevant Japanese wiring regulation.</p> <p>For cables other than those complying with JIS C 3662 series or JIS C 3663 series, the terminals shall be suitable for the size of the intended cables.</p>		N/A