



TEST REPORT

Reference No..... : WTX23X06126280E
 Applicant : GlobTek, Inc.
 Address : 186 Veterans Dr. Northvale, NJ 07647 USA
 Manufacturer : 1: GlobTek, Inc. 2: GlobTek (Suzhou) Co., Ltd
 Address : 1: 186 Veterans Dr. Northvale, NJ 07647 USA
 2: Building 4, No. 76, Jin Ling East Rd., Suzhou Industrial Park,
 Suzhou, Jiangsu 215021, China
 Product Name : Power Supply
 Model No..... : GT*96180-*****, GT*96300-*****, and GT*91120-****
 Standards : EN 60601-1-2:2015+A1:2021
 Date of Receipt sample : 2023-06-09
 Date of Test..... : 2023-06-24 to 2023-07-24
 Date of Issue : 2023-07-24
 Test Report Form No. : WTX_EN 60601_1_2_2015_B
 Test Result..... : Pass

Remarks:

The results shown in this test report refer only to the sample(s) tested, this test report cannot be reproduced, except in full, without prior written permission of the company. The report would be invalid without specific stamp of test institute and the signatures of approver.

Prepared By:

Waltek Testing Group (Shenzhen) Co., Ltd.

Address: 1/F., Room 101, Building 1, Hongwei Industrial Park, Liuxian 2nd Road,
Block 70 Bao'an District, Shenzhen, Guangdong, China

Tel.: +86-755-33663308 Fax.: +86-755-33663309 Email: sem@waltek.com.cn

Tested by:

Tom Ma

Approved by:

Silin Chen



TABLE OF CONTENTS

1. GENERAL INFORMATION5

1.1 PRODUCT DESCRIPTION FOR EQUIPMENT UNDER TEST (EUT)5

1.2 TEST STANDARDS7

1.3 TEST METHODOLOGY7

1.4 EUT SETUP AND OPERATION MODE8

1.5 PERFORMANCE CRITERIA FOR EMS9

1.6 TEST EQUIPMENT LIST AND DETAILS10

2. SUMMARY OF TEST RESULTS12

3. CONDUCTED EMISSION13

3.1 MEASUREMENT UNCERTAINTY13

3.2 BASIC TEST SETUP BLOCK DIAGRAM13

3.3 ENVIRONMENTAL CONDITIONS13

3.4 SUMMARY OF TEST RESULTS13

4. RADIATED EMISSION26

4.1 MEASUREMENT UNCERTAINTY26

4.2 BASIC TEST SETUP BLOCK DIAGRAM26

4.3 CORRECTED AMPLITUDE & MARGIN CALCULATION27

4.4 ENVIRONMENTAL CONDITIONS27

4.5 SUMMARY OF TEST RESULTS27

5. HARMONIC CURRENT EMISSIONS40

5.1 TEST PROCEDURE40

5.2 TEST STANDARDS40

5.3 ENVIRONMENTAL CONDITIONS40

5.4 BASIC TEST SETUP BLOCK DIAGRAM40

5.5 HARMONIC CURRENT EMISSIONS TEST DATA40

6. VOLTAGE FLUCTUATION FLICKER41

6.1 TEST PROCEDURE41

6.2 TEST STANDARDS41

6.3 ENVIRONMENTAL CONDITIONS41

6.4 BASIC TEST SETUP BLOCK DIAGRAM41

6.5 VOLTAGE FLUCTUATION AND FLICKER TEST DATA41

7. ELECTROSTATIC DISCHARGES (ESD)45

7.1 TEST PROCEDURE45

7.2 TEST PERFORMANCE45

7.3 ENVIRONMENTAL CONDITIONS45

7.4 BASIC TEST SETUP BLOCK DIAGRAM45

7.5 ELECTROSTATIC DISCHARGE IMMUNITY TEST DATA46

8. CONTINUOUS RF ELECTROMAGNETIC FIELD DISTURBANCES (RS)47

8.1 TEST PROCEDURE47

8.2 TEST PERFORMANCE47

8.3 ENVIRONMENTAL CONDITIONS47

8.4 BASIC TEST SETUP BLOCK DIAGRAM47

8.5 CONTINUOUS RADIATED DISTURBANCES TEST DATA48

9. ELECTRICAL FAST TRANSIENTS (EFT)49

9.1 TEST PROCEDURE49

9.2 TEST PERFORMANCE49

9.3 ENVIRONMENTAL CONDITIONS49

9.4 BASIC TEST SETUP BLOCK DIAGRAM49

9.5 ELECTRICAL FAST TRANSIENTS TEST DATA50

10. SURGES51

10.1 TEST PROCEDURE51

10.2 TEST PERFORMANCE51



Reference No.: WTX23X06126280E

10.3 ENVIRONMENTAL CONDITIONS.....	51
10.4 BASIC TEST SETUP BLOCK DIAGRAM	51
10.5 SURGE TEST DATA	51
11. CONTINUOUS INDUCED RF DISTURBANCES (C/S).....	52
11.1 TEST PROCEDURE	52
11.2 TEST PERFORMANCE.....	52
11.3 ENVIRONMENTAL CONDITIONS	52
11.4 BASIC TEST SETUP BLOCK DIAGRAM.....	52
11.5 CONTINUOUS CONDUCTED DISTURBANCES TEST DATA.....	53
12. POWER-FREQUENCY MAGNETIC FIELDS (PFMF).....	54
12.1 TEST PROCEDURE	54
12.2 TEST PERFORMANCE	54
12.3 ENVIRONMENTAL CONDITIONS	54
12.4 BASIC TEST SETUP BLOCK DIAGRAM	54
12.5 POWER-FREQUENCY MAGNETIC FIELD TEST DATA	54
13. VOLTAGE DIPS AND INTERRUPTIONS.....	55
13.1 TEST PROCEDURE	55
13.2 TEST PERFORMANCE	55
13.3 ENVIRONMENTAL CONDITIONS	55
13.4 BASIC TEST SETUP BLOCK DIAGRAM	55
13.5 VOLTAGE DIPS AND INTERRUPTIONS TEST DATA	55
EXHIBIT 1 - PRODUCT LABELING.....	56
PROPOSED CE LABEL FORMAT	56
PROPOSED LABEL LOCATION ON EUT	56
EXHIBIT 2 - EUT PHOTOGRAPHS	57
EXHIBIT 3 - TEST SETUP PHOTOGRAPHS.....	71

WALTERK



Report version


Version No.	Date of issue	Description
Rev.00	2023-07-24	Original
/	/	/

WALTEK



1. GENERAL INFORMATION

1.1 Product Description for Equipment Under Test (EUT)

General Description of EUT	
Product Name:	Power Supply
Trade Name:	
Model No.:	GT*96180-*****, GT*96300-*****, and GT*91120-*****
Adding Model(s):	/
<p><i>Note: The test data is gathered from a production sample, provided by the manufacturer. The appearance of others models listed in the report is different from main-test model GT*96180-*****, GT*96300-*****, and GT*91120-*****, but the circuit and the electronic construction do not change, declared by the manufacturer.</i></p> <p><i>GT*96180-*****,</i></p> <p><i>The 1st "*" part can be 'M' or '-' or 'H' for market identification and not related to safety.</i></p> <p><i>The 2nd "*" denotes the rated output wattage designation, which can be "01" to "18", with interval of 1.</i></p> <p><i>The 3rd "*" denotes the standard rated output voltage designation, which can be "07", "11", "17.9", "30", "38", "48", "54" or "56";</i></p> <p><i>The 4th "*" is optional deviation, subtracted from standard output voltage, which can be "-0.01" to "-12.0" with interval of 0.01, or blank to indicate no voltage different.</i></p> <p><i>The 3rd "*" and 4th "*" together denote the output voltage, with a range of 5 - 56 volts.</i></p> <p><i>The 5th "*" = blank, it means wall plug in with interchangeable blade</i></p> <p><i>=-T2 means desktop class II with C8 AC inlet</i></p> <p><i>=-T2A means desktop class II with C18 AC inlet</i></p> <p><i>=-T3 means desktop class I or class II with functional earth with C14 AC inlet</i></p> <p><i>=-T3A means desktop class I or class II with functional earth with C6 AC inlet</i></p> <p><i>The 6th "*" = Blank or -AP or -PP or -SP</i></p> <p><i>-AP (with baby board) stands for Active POE (full IEEE compliant)</i></p> <p><i>-PP (no baby board) stands for Passive POE</i></p> <p><i>-SP (no baby board) stands for Simple POE</i></p> <p><i>The last * denote any six character = 0-9 or A-Z or () [] or - or blank for marketing purposes.</i></p> <p><i>GT*96300-*****, and GT*91120-*****,</i></p> <p><i>The 1st "*" part can be 'M' or '-' or 'H' for market identification and not related to safety.</i></p> <p><i>The 2nd "*" denotes the rated output wattage designation, which can be "01" to "36", with interval of 1.</i></p> <p><i>The 3rd "*" denotes the standard rated output voltage designation, which can be "07.5", "10.5", "14.5", "19.5", "24", "36", "48", "54" or "56";</i></p> <p><i>The 4th "*" is optional deviation, subtracted from standard output voltage, which can be "-0.01" to "-11.9" with interval of 0.01, or blank to indicate no voltage different.</i></p> <p><i>The 3rd "*" and 4th "*" together denote the output voltage, with a range of 5 - 56 volts.</i></p>	



Reference No.: WTX23X06126280E

The 5th "" = -T2 means desktop class II with C8 AC inlet
 =-T2A means desktop class II with C18 AC inlet
 =-T3 means desktop class I or class II with functional earth with C14 AC inlet
 =-T3A means desktop class I or class II with functional earth with C6 AC inlet
 =-R2 means hybrid desktop housing class II with C8 AC inlet
 =-R3A means hybrid desktop housing class I or class II with functional earth with C6 AC inlet
 =-F means Open Frame class I or class II with functional earth
 =-FW means Open Frame class II
 =-P2 means Encapsulated class II
 =-P3 means Encapsulated class I or class II with functional earth*

The 6th "" = Blank or -AP or -PP or -SP
 -AP (with baby board) stands for Active POE (full IEEE compliant)
 -PP (no baby board) stands for Passive POE
 -SP (no baby board) stands for Simple POE*

*The last * denote any six character = 0-9 or A-Z or () [] or – or blank for marketing purposes.*

Technical Characteristics of EUT	
Rated Voltage/ Current:	Input: AC 100-240V~,50-60Hz or 50/60Hz, 0.6A/1.0A/1.5A Output: 5-56VDC, Max.4.5A, Max. 36W
Rated Power:	/
Power Adaptor Model:	/
Highest Internal Frequency:	Below 108MHz
Classification of Equipment:	Class B



1.2 Test Standards

The tests were performed according to following standards:

EN 60601-1-2:2015+A1:2021:Medical electrical equipment – Part 1-2: General requirements for basic safety and essential performance – Collateral standard: Electromagnetic compatibility – Requirements and tests.

Maintenance of compliance is the responsibility of the manufacturer. Any modification of the product maybe which result in lowering the emission/immunity should be checked to ensure compliance has been maintained.

1.3 Test Methodology

All measurements contained in this report were conducted with the standards IEC 60601-1-2 for Medical electrical equipment – Part 1-2: General requirements for basic safety and essential performance – Collateral standard:Electromagnetic compatibility – Requirements and tests.

WALTEK



1.4 EUT Setup and Operation Mode

The equipment under test (EUT) was configured to measure its highest possible emission/immunity level. The test modes were adapted according to the operation manual for use, more detailed description as follows:

Test Mode List			
Test Mode	Description	Remark	Power Supply Mode
TM1	Working mode	Model:GTM96180-1811-2.0-T3 Output:DC 9V/2A	AC 230V/50Hz
TM2	Working mode	Model:GTM91120-3024-T3A Output:DC 24V/1.25A	AC 230V/50Hz
TM3	Working mode	Model:GTM96300-3624-T2 Output:DC 24V/1.5A	AC 230V/50Hz
TM4	Working mode	Model:GTM96180-1811-2.0-T3 Output:DC 9V/2A	AC 120V/60Hz
TM5	Working mode	Model:GTM91120-3024-T3A Output:DC 24V/1.25A	AC 120V/60Hz
TM6	Working mode	Model:GTM96300-3624-T2 Output:DC 24V/1.5A	AC 120V/60Hz

EUT Cable List and Details				
Cable Description	Length (m)	Shielded/Unshielded	With / Without Ferrite	With / Without Chip
Model:GTM96180-1811-2.0-T3 DC Cable	1.8	Unshielded	Without	Without
Model:GTM96300-3624-T2 DC Cable	1.53	Shielded	Without	Without
Model:GTM91120-3024-T3A DC Cable	1.85	Shielded	With	Without

Special Cable List and Details				
Cable Description	Length (m)	Shielded/Unshielded	With / Without Ferrite	With / Without Chip
/	/	/	/	/

Auxiliary Equipment List and Details			
Description	Manufacturer	Model	Serial Number
Load	/	/	/



1.5 Performance Criteria for EMS

All the test data has been collected, reduced, and analyzed within this report in accordance with Immunity requires the following as specific performance criteria:

- A. The apparatus shall continue to operate as intended during and after the test. The manufacturer specifies some minimum performance level. The performance level may be specified by the manufacturer as a permissible loss of performance.
- B. The apparatus shall continue to operate as intended after the test. This indicates that the EUT does not need to function at normal performance levels during the test, but must recover. Again some minimal performance is defined by the manufacturer. No change in operating state or loss of data is permitted.
- C. Temporary loss of function is allowed. Operation of the EUT may stop as long as it is either automatically reset or can be manually restored by operation of the controls.

WALTEK



1.6 Test Equipment List and Details

Description	Manufacturer	Model	Serial No.	Cal. Date	Due. Date
<input type="checkbox"/> Chamber A: Below 1GHz					
Spectrum Analyzer	Rohde & Schwarz	FSP30	836079/035	2023-02-25	2024-02-24
EMI Test Receiver	Rohde & Schwarz	ESVB	825471/005	2023-02-25	2024-02-24
Trilog Broadband Antenna	Schwarz beck	VULB9163	9163-333	2023-03-20	2026-03-19
Loop Antenna	Schwarz beck	FMZB 1516	9773	2021-03-20	2024-03-19
Amplifier	HP	8447F	2805A03475	2023-02-25	2024-02-24
<input type="checkbox"/> Chamber A: Above 1GHz					
Amplifier	C&D	PAP-1G18	2002	2023-02-25	2024-02-24
Horn Antenna	ETS	3117	00086197	2021-03-19	2024-03-18
<input checked="" type="checkbox"/> Chamber B: Below 1GHz					
Trilog Broadband Antenna	Schwarz beck	VULB9163(B)	9163-635	2021-04-09	2024-04-08
Amplifier	Agilent	8447D	2944A10179	2023-02-25	2024-02-24
EMI Test Receiver	Rohde & Schwarz	ESPI	101391	2023-02-25	2024-02-24
<input type="checkbox"/> Chamber C: Below 1GHz					
EMI Test Receiver	Rohde & Schwarz	ESIB 26	100401	2023-02-25	2024-02-24
Trilog Broadband Antenna	Schwarz beck	VULB 9168	1194	2021-05-28	2024-05-27
Amplifier	HP	8447F	2944A03869	2023-02-25	2024-02-24
<input type="checkbox"/> Chamber C: Above 1GHz					
Horn Antenna	POAM	RTF-11A	LP228060221	2023-03-10	2026-03-09
Amplifier	Tonscend	TAP01018050	AP22E806235	2023-02-25	2024-02-24
<input checked="" type="checkbox"/> Conducted Room 1#					
EMI Test Receiver	Rohde & Schwarz	ESPI	101611	2023-02-25	2024-02-24
Pulse Limiter	Rohde & Schwarz	ESH3-Z2	100911	2023-02-25	2024-02-24
AC LISN	Schwarz beck	NSLK8126	8126-224	2023-02-25	2024-02-24
8-WIRE LISN	Schwarz beck	8158	CAT3-8158-0059	2023-02-25	2024-02-24
8-WIRE LISN	Schwarz beck	8158	CAT5-8158-0117	2023-02-25	2024-02-24
<input type="checkbox"/> Conducted Room 2#					
EMI Test Receiver	Rohde & Schwarz	ESPI	10129	2023-02-25	2024-02-24
LISN	Rohde & Schwarz	ENV 216	100097	2023-02-25	2024-02-24
<input checked="" type="checkbox"/> Harmonics & Flicker					
Digital Power Analyzer	California Instrument	CTS	72831	2023-02-25	2024-02-24
Power Source	California Instrument	5001IX-CTS-400	25965	2023-02-25	2024-02-24
<input checked="" type="checkbox"/> Electrostatic discharges					
ESD Generator	LIONCEL	ESD-203B	0170901	2023-03-14	2024-03-13



<input checked="" type="checkbox"/> Power-frequency magnetic field (PFMF)					
PMF Generator	LIONCEL	PMF-801C-C	0171101	2023-02-25	2024-02-24
PMF Antenna	LIONCEL	PMF-801C-A	0180302	2023-02-25	2024-02-24
Instantaneous PMF Generator Module	LIONCEL	PMF-801C-T	0171001	2023-02-25	2024-02-24
<input checked="" type="checkbox"/> Electronic fast transient(EFT)/Surges/Dips					
Transient 2000	EMC PARTNER	TRA2000	863	2023-02-25	2024-02-24
Couple Clamp	EMC PARTNER	CN-EFT1000	513	2023-02-25	2024-02-24
<input checked="" type="checkbox"/> Radio frequency, continuous conducted (C/S)					
CONDUCTED IMMUNITY TEST SYSTEM	FRANKONIA	CIT-10/75	126B1247/2013	2023-02-25	2024-02-24
Attenuator	EMTEST	MA-5100/6BF2	1009	2023-02-25	2024-02-24
CDN	Luthi	L-801M2/M3	2665	2023-02-25	2024-02-24
CDN	LIONCEL	CDN-T8	0210401	2023-02-25	2024-02-24
EM Clamp	TESEQ	KEMZ801A	45028	2023-02-25	2024-02-24
<input checked="" type="checkbox"/> Radio frequency electromagnetic Field (R/S)					
Signal Generator	HP	8688B	3438A00604	2023-02-25	2024-02-24
Power Sensor	Agilent	E9301A	MY52450001	2023-02-25	2024-02-24
Power Sensor	Agilent	E9304A	MY55081055	2023-02-25	2024-02-24
RF Power Amplifier	MicoTop	MPA-80-1000-250	MPA1906239	2023-02-25	2024-02-24
RF Power Amplifier	MicoTop	MPA-1000-6000-100	MPA1906238	2023-02-25	2024-02-24
Antenna	SCHWARZBECK	STLP 9129	9129 114	N/A	N/A
Power Meter	Agilent	E4419B	GB42420578	2023-02-25	2024-02-24



2. SUMMARY OF TEST RESULTS

Standards	Description of Test Item	Result
EN 60601-1-2	Conducted Disturbance	Compliant
	Radiated Disturbance	Compliant
	Harmonic Current Emission IEC 61000-3-2	Compliant
	Voltage Fluctuation and Flicker IEC 61000-3-3	Compliant
	Electrostatic Discharge Immunity in accordance with IEC 61000-4-2	Compliant
	Continuous Radiated Disturbances Immunity in accordance with IEC 61000-4-3	Compliant
	Electrical Fast Transient/Burst Immunity in accordance With IEC 61000-4-4	Compliant
	Surges Immunity in accordance with IEC 61000-4-5	Compliant
	Continuous Conducted Disturbances Immunity in accordance with IEC 61000-4-6	Compliant
	Power-frequency Magnetic Fields Immunity in accordance with IEC 61000-4-8	Compliant
	Voltage Dips/Interruptions Immunity in accordance with IEC 61000-4-11	Compliant

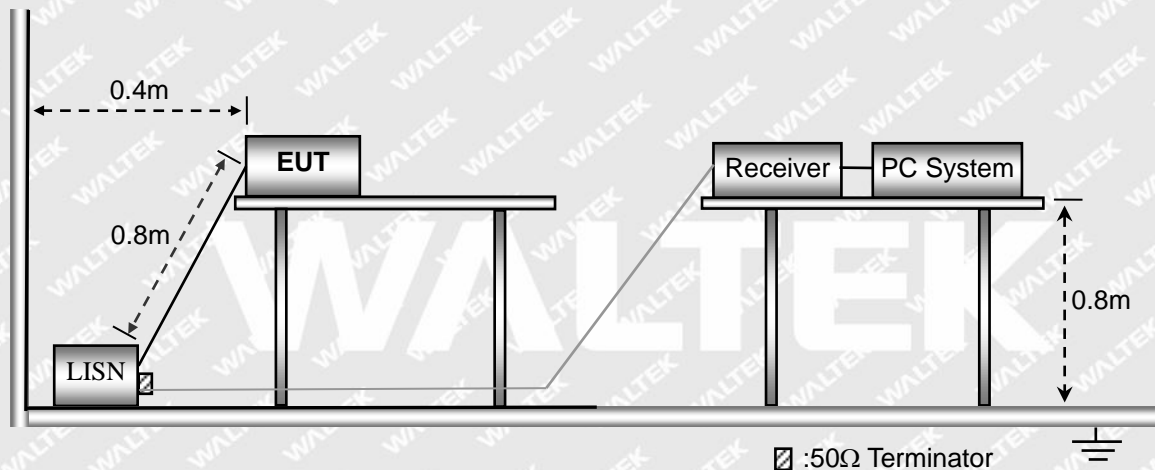
3. Conducted Emission

3.1 Measurement Uncertainty

Base on NIS 81, The Treatment of Uncertainty in EMC Measurements, the best estimate of the uncertainty of any conducted emissions measurement:

Measurement uncertainty		
Parameter	Conditions	Uncertainty
Conducted Emissions	Conducted	9-150kHz ± 3.74 dB
		0.15-30MHz ± 3.34 dB

3.2 Basic Test Setup Block Diagram



3.3 Environmental Conditions

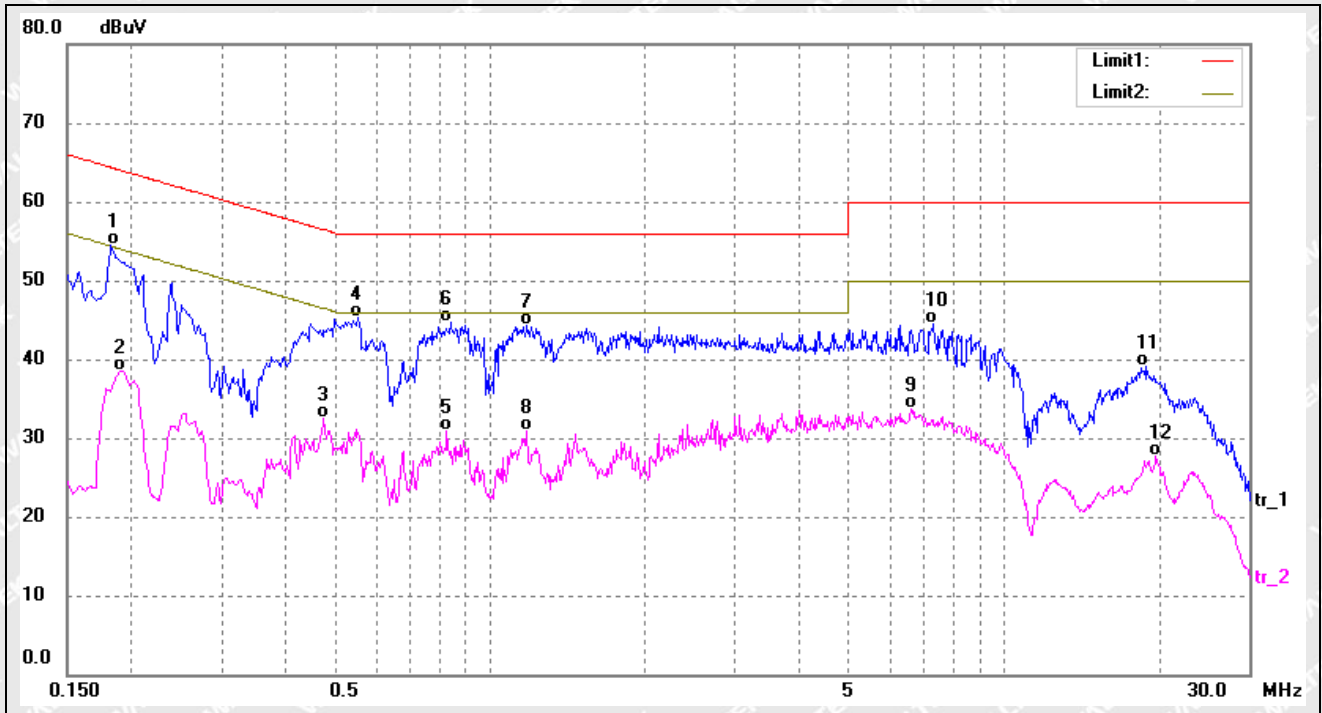
Temperature:	23.5 °C
Relative Humidity:	54 %
ATM Pressure:	997 mbar

3.4 Summary of Test Results

Please find the results below:



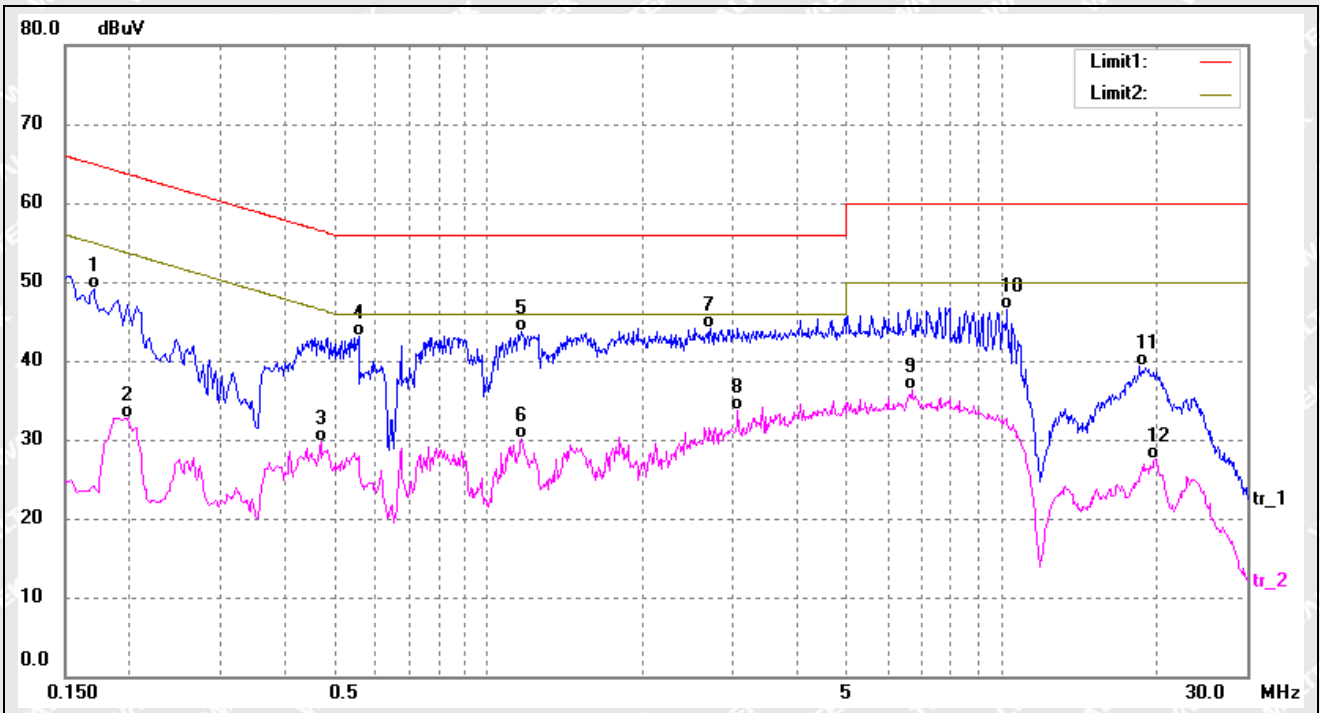
Test mode:	TM1	Polarity:	Line
------------	-----	-----------	------



No.	Frequency (MHz)	Reading (dBuV)	Correct (dB)	Result (dBuV)	Limit (dBuV)	Margin (dB)	Detector
1*	0.1819	44.20	10.39	54.59	64.39	-9.80	QP
2	0.1900	28.18	10.39	38.57	54.03	-15.46	AVG
3	0.4740	22.31	10.24	32.55	46.44	-13.89	AVG
4	0.5540	35.01	10.22	45.23	56.00	-10.77	QP
5	0.8260	20.69	10.17	30.86	46.00	-15.14	AVG
6	0.8380	34.50	10.17	44.67	56.00	-11.33	QP
7	1.1820	34.11	10.18	44.29	56.00	-11.71	QP
8	1.1820	20.79	10.18	30.97	46.00	-15.03	AVG
9	6.6220	23.25	10.38	33.63	50.00	-16.37	AVG
10	7.3140	34.07	10.38	44.45	60.00	-15.55	QP
11	18.9980	28.66	10.35	39.01	60.00	-20.99	QP
12	19.8260	17.29	10.38	27.67	50.00	-22.33	AVG



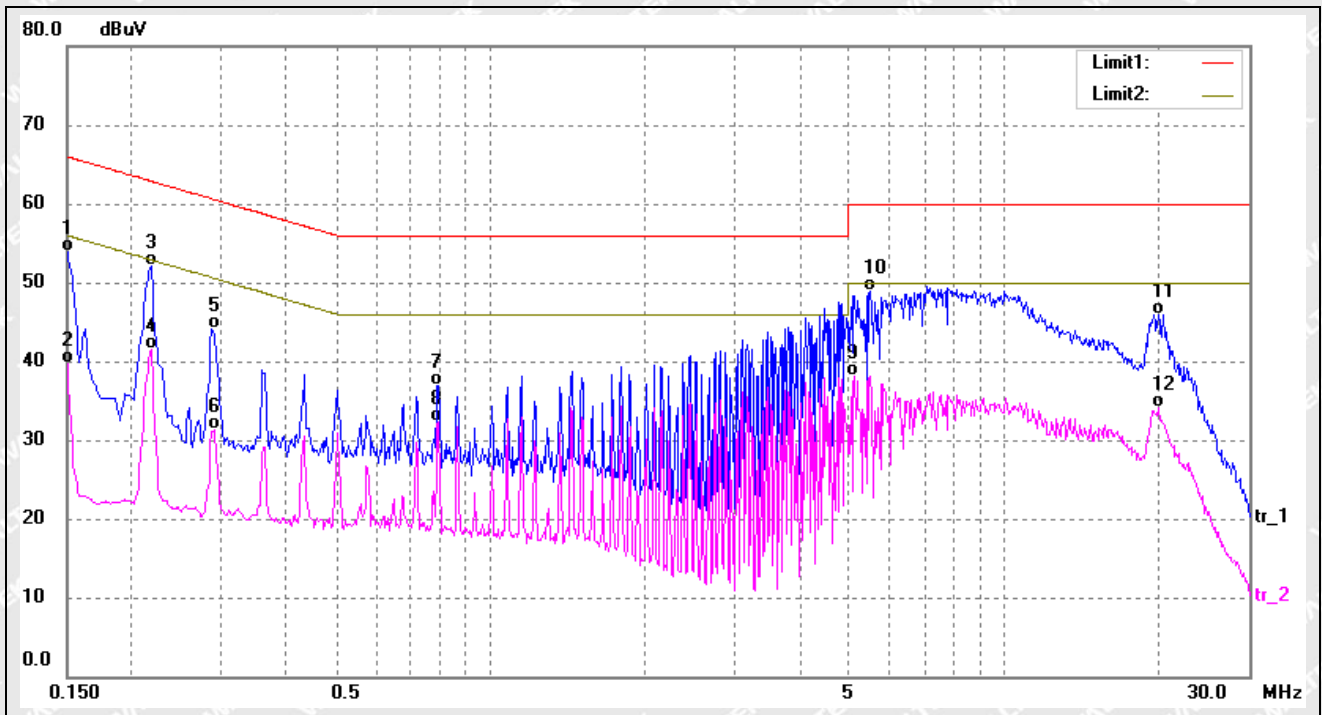
Test mode:	TM1	Polarity:	Neutral
------------	-----	-----------	---------



No.	Frequency (MHz)	Reading (dBuV)	Correct (dB)	Result (dBuV)	Limit (dBuV)	Margin (dB)	Detector
1	0.1700	38.75	10.40	49.15	64.96	-15.81	QP
2	0.1980	22.39	10.39	32.78	53.69	-20.91	AVG
3	0.4700	19.43	10.25	29.68	46.51	-16.83	AVG
4	0.5580	32.83	10.22	43.05	56.00	-12.95	QP
5	1.1620	33.49	10.17	43.66	56.00	-12.34	QP
6	1.1620	20.02	10.17	30.19	46.00	-15.81	AVG
7*	2.7139	33.84	10.34	44.18	56.00	-11.82	QP
8	3.0620	23.33	10.35	33.68	46.00	-12.32	AVG
9	6.6700	25.83	10.38	36.21	50.00	-13.79	AVG
10	10.2540	36.13	10.37	46.50	60.00	-13.50	QP
11	18.6180	29.01	10.33	39.34	60.00	-20.66	QP
12	19.9140	17.20	10.38	27.58	50.00	-22.42	AVG



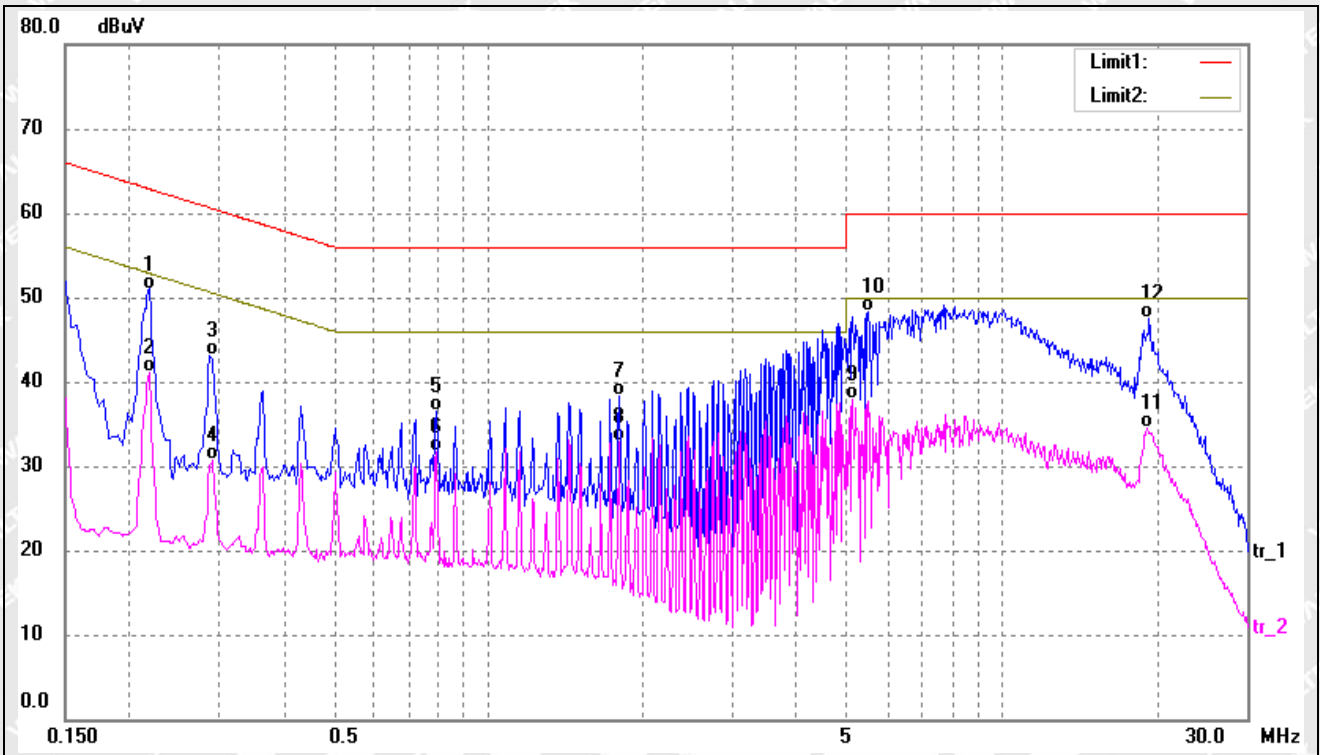
Test mode:	TM2	Polarity:	Line
------------	-----	-----------	------



No.	Frequency (MHz)	Reading (dBuV)	Correct (dB)	Result (dBuV)	Limit (dBuV)	Margin (dB)	Detector
1	0.1500	43.44	10.40	53.84	65.99	-12.15	QP
2	0.1500	29.28	10.40	39.68	55.99	-16.31	AVG
3*	0.2180	41.80	10.37	52.17	62.89	-10.72	QP
4	0.2180	31.17	10.37	41.54	52.89	-11.35	AVG
5	0.2860	33.84	10.31	44.15	60.64	-16.49	QP
6	0.2900	21.01	10.31	31.32	50.52	-19.20	AVG
7	0.7900	26.68	10.18	36.86	56.00	-19.14	QP
8	0.7940	22.09	10.18	32.27	46.00	-13.73	AVG
9	5.1180	27.72	10.38	38.10	50.00	-11.90	AVG
10	5.4780	38.51	10.38	48.89	60.00	-11.11	QP
11	19.9619	35.61	10.38	45.99	60.00	-14.01	QP
12	19.9619	23.73	10.38	34.11	50.00	-15.89	AVG



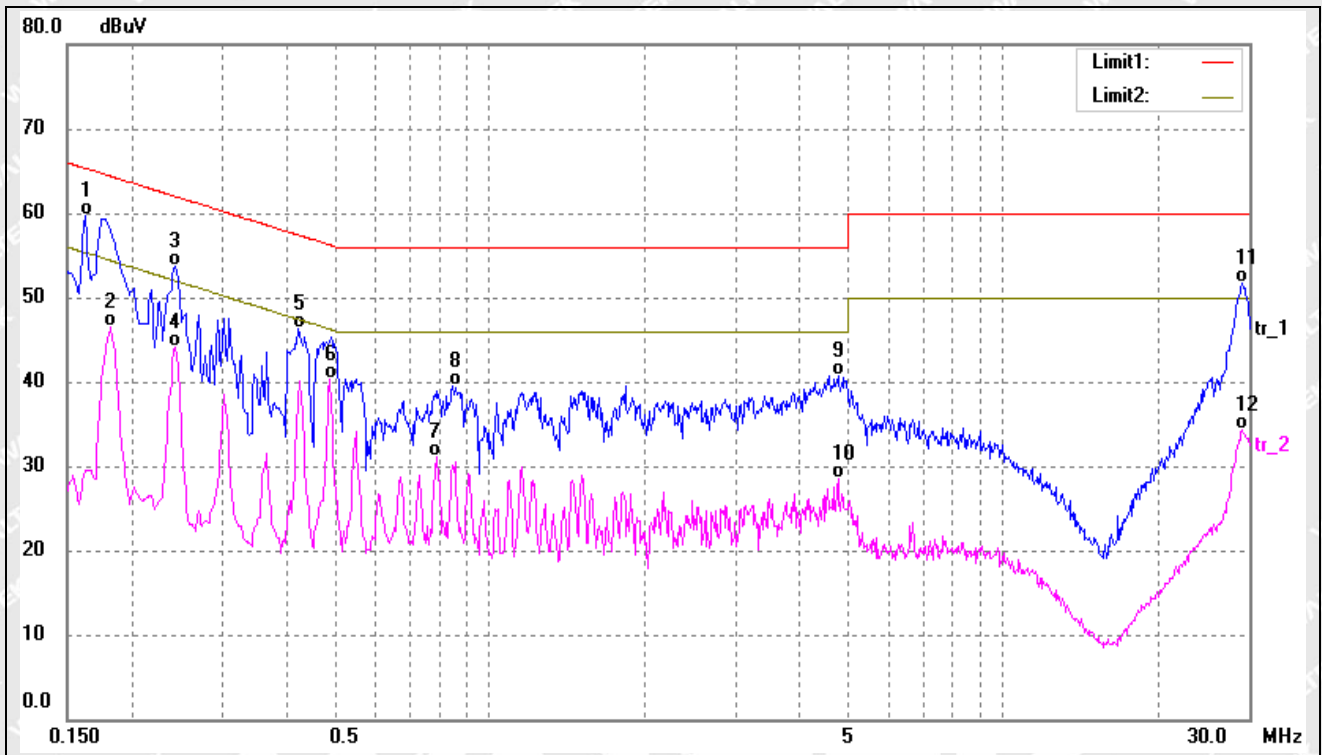
Test mode:	TM2	Polarity:	Neutral
------------	-----	-----------	---------



No.	Frequency (MHz)	Reading (dBuV)	Correct (dB)	Result (dBuV)	Limit (dBuV)	Margin (dB)	Detector
1	0.2180	40.63	10.37	51.00	62.89	-11.89	QP
2	0.2180	30.74	10.37	41.11	52.89	-11.78	AVG
3	0.2860	32.73	10.31	43.04	60.64	-17.60	QP
4	0.2900	20.33	10.31	30.64	50.52	-19.88	AVG
5	0.7940	26.37	10.18	36.55	56.00	-19.45	QP
6	0.7940	21.43	10.18	31.61	46.00	-14.39	AVG
7	1.7980	27.94	10.29	38.23	56.00	-17.77	QP
8	1.7980	22.70	10.29	32.99	46.00	-13.01	AVG
9	5.1180	27.58	10.38	37.96	50.00	-12.04	AVG
10*	5.4780	37.84	10.38	48.22	60.00	-11.78	QP
11	19.1860	24.17	10.35	34.52	50.00	-15.48	AVG
12	19.3980	37.09	10.36	47.45	60.00	-12.55	QP



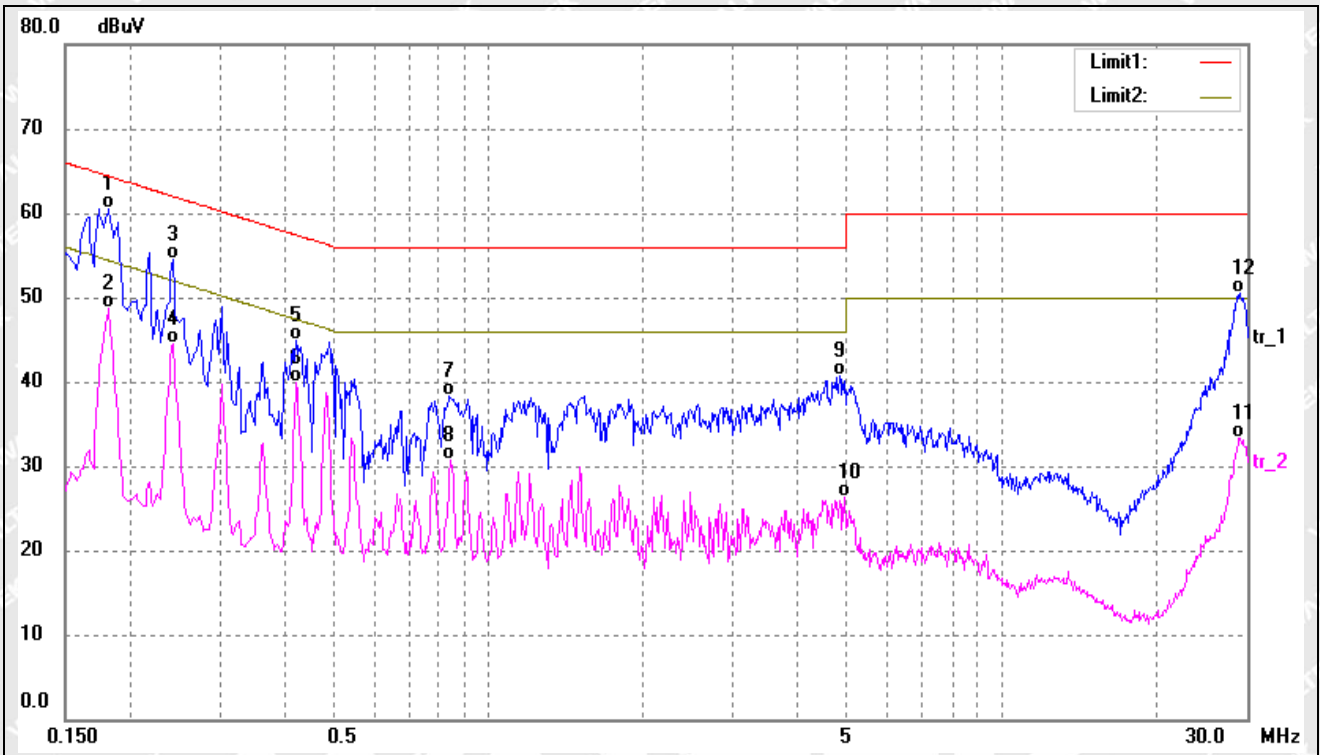
Test mode:	TM3	Polarity:	Line
------------	-----	-----------	------



No.	Frequency (MHz)	Reading (dBuV)	Correct (dB)	Result (dBuV)	Limit (dBuV)	Margin (dB)	Detector
1*	0.1620	49.27	10.40	59.67	65.36	-5.69	QP
2	0.1819	36.16	10.39	46.55	54.39	-7.84	AVG
3	0.2420	43.33	10.35	53.68	62.02	-8.34	QP
4	0.2420	33.80	10.35	44.15	52.02	-7.87	AVG
5	0.4220	36.11	10.26	46.37	57.41	-11.04	QP
6	0.4860	30.07	10.23	40.30	46.24	-5.94	AVG
7	0.7860	21.01	10.18	31.19	46.00	-14.81	AVG
8	0.8460	29.26	10.17	39.43	56.00	-16.57	QP
9	4.7660	30.41	10.38	40.79	56.00	-15.21	QP
10	4.7660	18.18	10.38	28.56	46.00	-17.44	AVG
11	29.1860	41.49	10.31	51.80	60.00	-8.20	QP
12	29.1860	23.97	10.31	34.28	50.00	-15.72	AVG



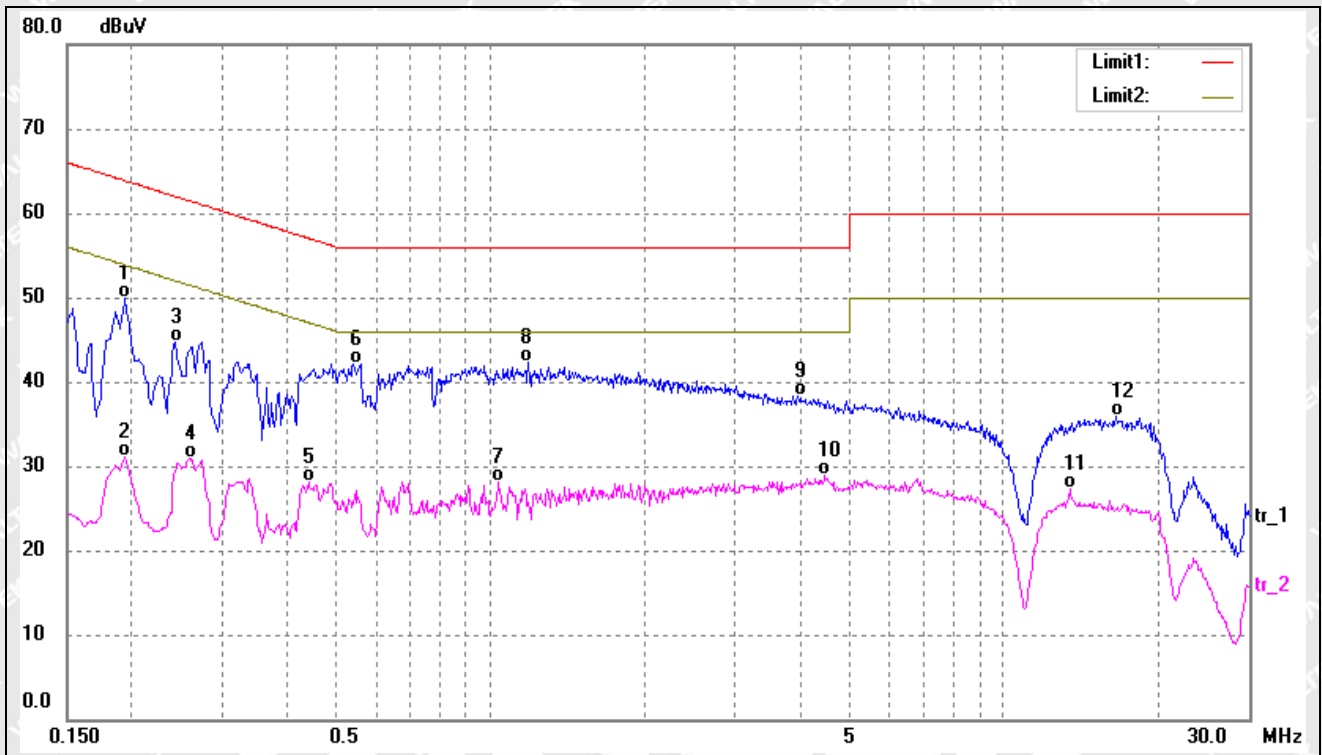
Test mode:	TM3	Polarity:	Neutral
------------	-----	-----------	---------



No.	Frequency (MHz)	Reading (dBuV)	Correct (dB)	Result (dBuV)	Limit (dBuV)	Margin (dB)	Detector
1*	0.1819	50.15	10.39	60.54	64.39	-3.85	QP
2	0.1819	38.31	10.39	48.70	54.39	-5.69	AVG
3	0.2420	44.07	10.35	54.42	62.02	-7.60	QP
4	0.2420	34.18	10.35	44.53	52.02	-7.49	AVG
5	0.4220	34.63	10.26	44.89	57.41	-12.52	QP
6	0.4220	29.65	10.26	39.91	47.41	-7.50	AVG
7	0.8420	28.06	10.17	38.23	56.00	-17.77	QP
8	0.8460	20.46	10.17	30.63	46.00	-15.37	AVG
9	4.8380	30.27	10.38	40.65	56.00	-15.35	QP
10	4.9300	15.86	10.38	26.24	46.00	-19.76	AVG
11	29.0420	23.07	10.31	33.38	50.00	-16.62	AVG
12	29.1140	40.14	10.31	50.45	60.00	-9.55	QP



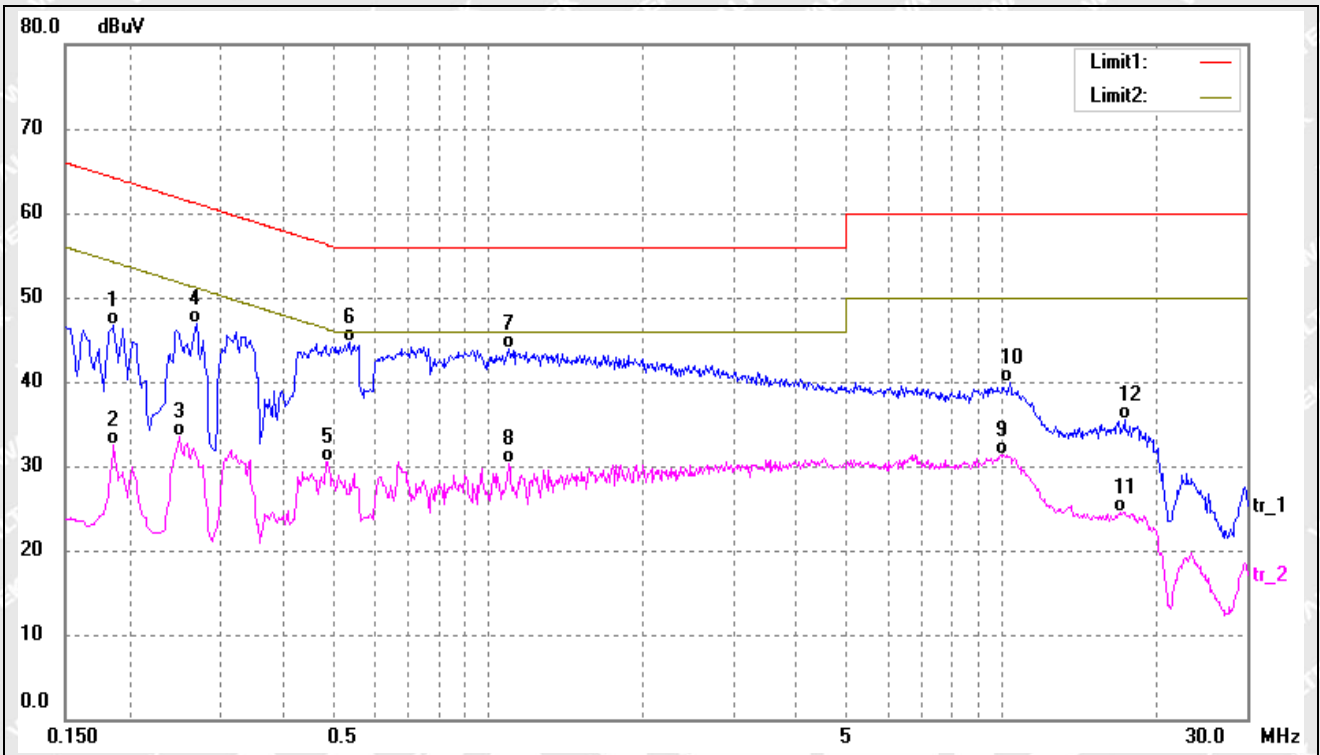
Test mode:	TM4	Polarity:	Line
------------	-----	-----------	------



No.	Frequency (MHz)	Reading (dBuV)	Correct (dB)	Result (dBuV)	Limit (dBuV)	Margin (dB)	Detector
1	0.1940	39.48	10.39	49.87	63.86	-13.99	QP
2	0.1940	20.81	10.39	31.20	53.86	-22.66	AVG
3	0.2420	34.44	10.35	44.79	62.02	-17.23	QP
4	0.2580	20.56	10.34	30.90	51.49	-20.59	AVG
5	0.4420	17.83	10.25	28.08	47.02	-18.94	AVG
6	0.5420	31.85	10.23	42.08	56.00	-13.92	QP
7	1.0380	17.88	10.14	28.02	46.00	-17.98	AVG
8*	1.1860	32.19	10.18	42.37	56.00	-13.63	QP
9	3.9740	28.03	10.36	38.39	56.00	-17.61	QP
10	4.4820	18.46	10.37	28.83	46.00	-17.17	AVG
11	13.4620	17.00	10.27	27.27	50.00	-22.73	AVG
12	16.5020	25.71	10.27	35.98	60.00	-24.02	QP



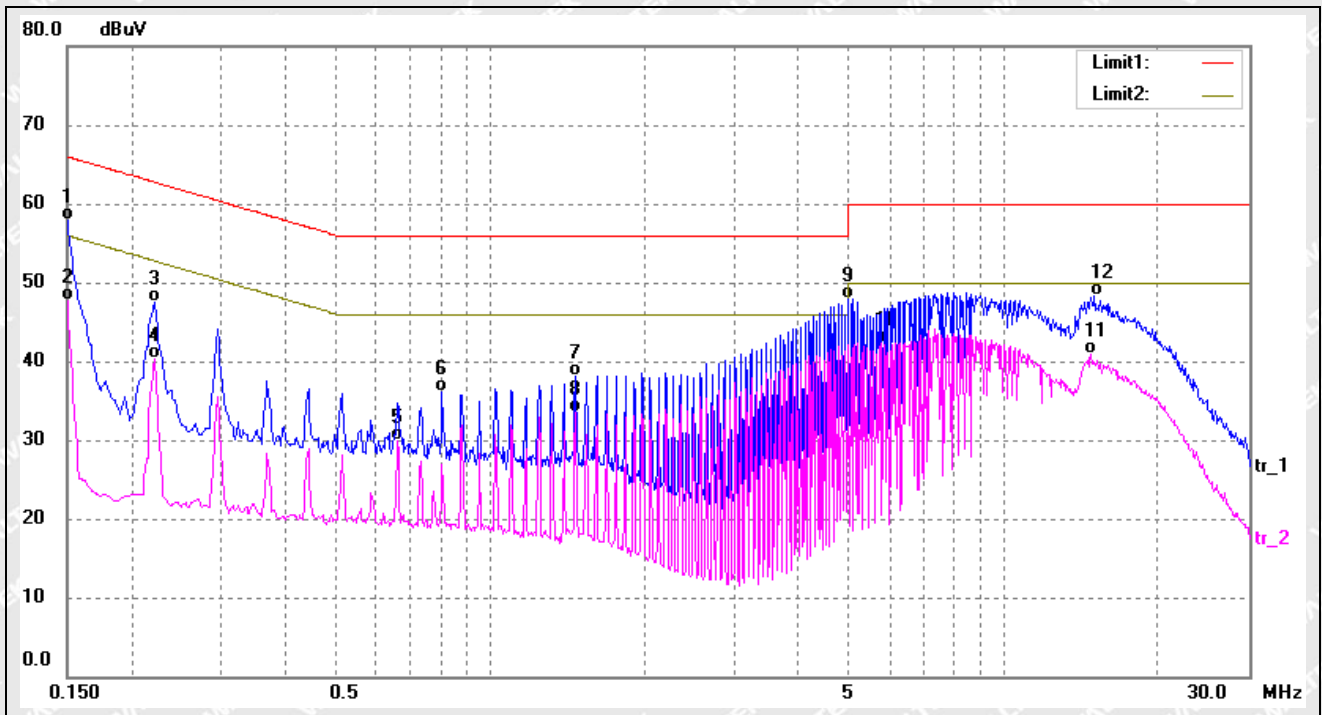
Test mode:	TM4	Polarity:	Neutral
------------	-----	-----------	---------



No.	Frequency (MHz)	Reading (dBuV)	Correct (dB)	Result (dBuV)	Limit (dBuV)	Margin (dB)	Detector
1	0.1860	36.30	10.40	46.70	64.21	-17.51	QP
2	0.1860	22.18	10.40	32.58	54.21	-21.63	AVG
3	0.2500	23.19	10.34	33.53	51.75	-18.22	AVG
4	0.2700	36.54	10.33	46.87	61.12	-14.25	QP
5	0.4860	20.34	10.23	30.57	46.24	-15.67	AVG
6*	0.5340	34.44	10.23	44.67	56.00	-11.33	QP
7	1.0980	33.72	10.16	43.88	56.00	-12.12	QP
8	1.0980	20.11	10.16	30.27	46.00	-15.73	AVG
9	10.0460	21.02	10.38	31.40	50.00	-18.60	AVG
10	10.3820	29.52	10.37	39.89	60.00	-20.11	QP
11	17.0220	14.30	10.28	24.58	50.00	-25.42	AVG
12	17.2939	25.15	10.30	35.45	60.00	-24.55	QP



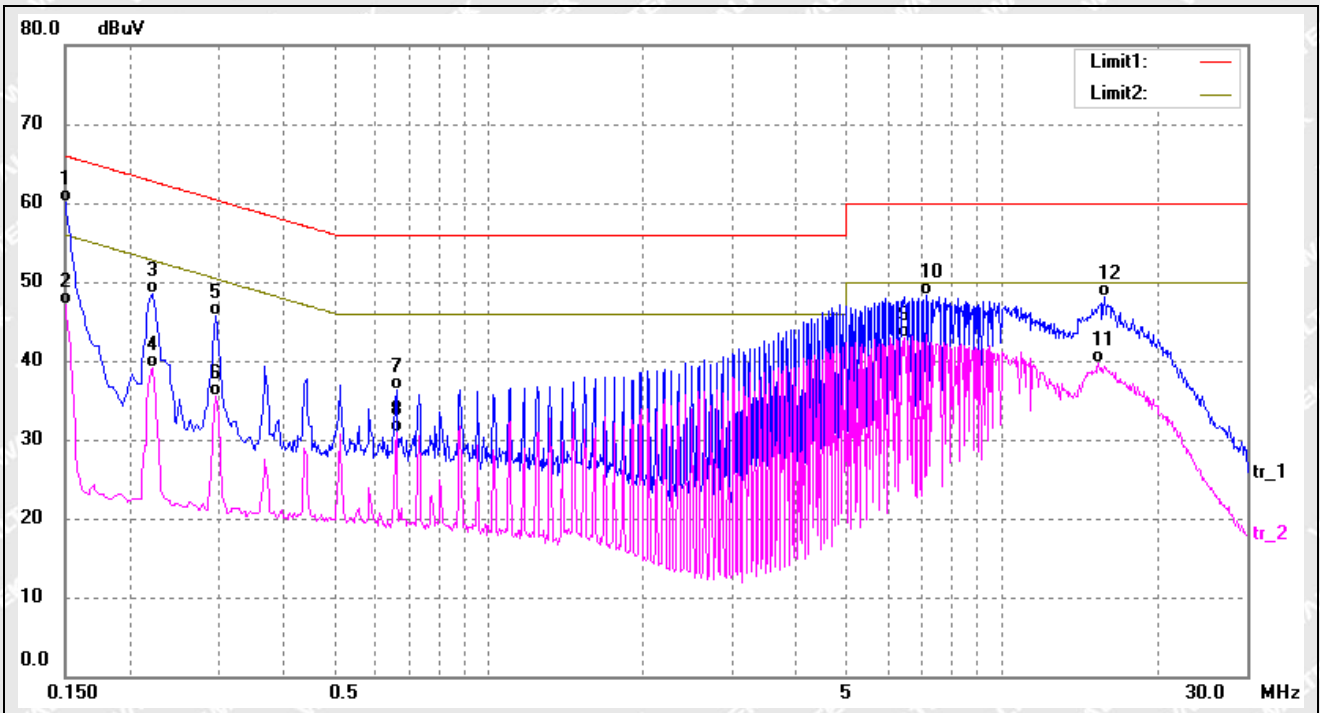
Test mode:	TM5	Polarity:	Line
------------	-----	-----------	------



No.	Frequency (MHz)	Reading (dBuV)	Correct (dB)	Result (dBuV)	Limit (dBuV)	Margin (dB)	Detector
1	0.1500	47.50	10.40	57.90	65.99	-8.09	QP
2	0.1500	37.34	10.40	47.74	55.99	-8.25	AVG
3	0.2220	37.13	10.37	47.50	62.74	-15.24	QP
4	0.2220	30.00	10.37	40.37	52.74	-12.37	AVG
5	0.6580	19.77	10.20	29.97	46.00	-16.03	AVG
6	0.8059	25.92	10.18	36.10	56.00	-19.90	QP
7	1.4660	27.78	10.23	38.01	56.00	-17.99	QP
8	1.4660	23.31	10.23	33.54	46.00	-12.46	AVG
9	4.9860	37.61	10.38	47.99	56.00	-8.01	QP
10*	5.7940	31.99	10.38	42.37	50.00	-7.63	AVG
11	14.8060	30.73	10.22	40.95	50.00	-9.05	AVG
12	15.0220	38.00	10.22	48.22	60.00	-11.78	QP



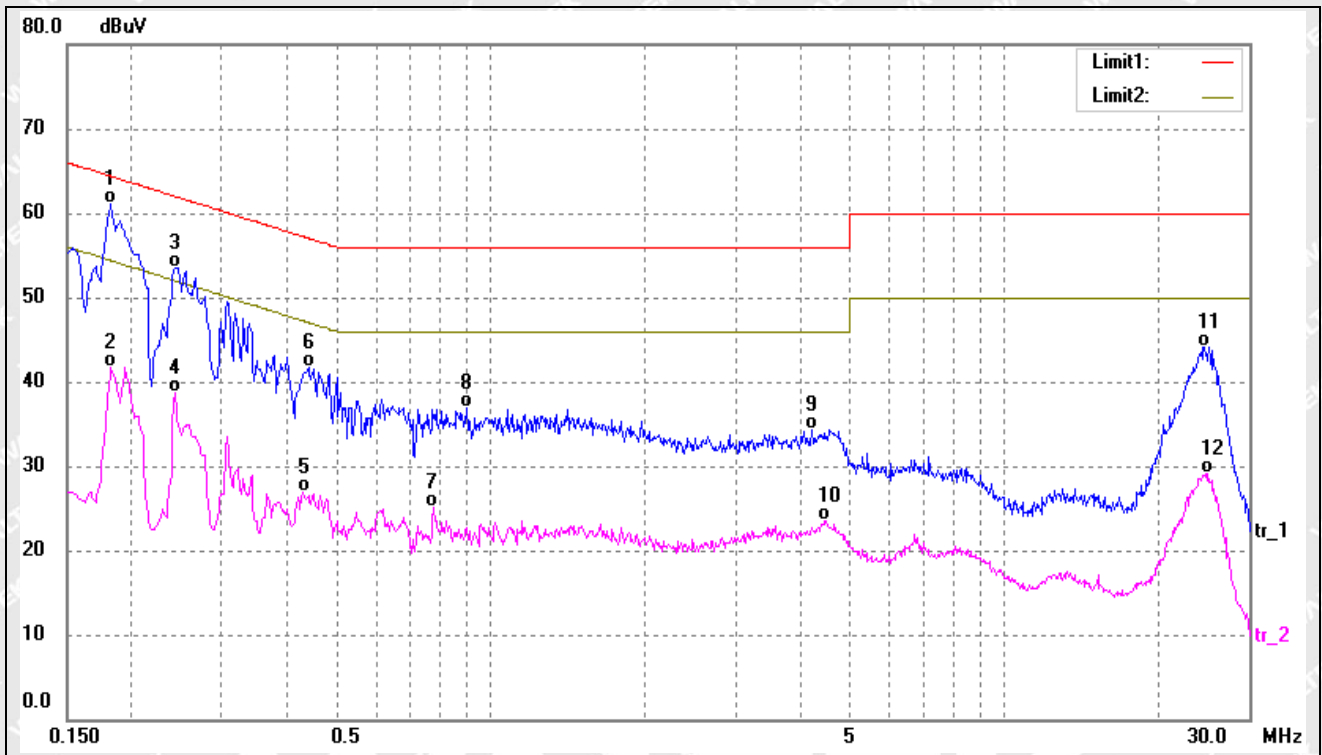
Test mode:	TM5	Polarity:	Neutral
------------	-----	-----------	---------



No.	Frequency (MHz)	Reading (dBuV)	Correct (dB)	Result (dBuV)	Limit (dBuV)	Margin (dB)	Detector
1*	0.1500	49.73	10.40	60.13	65.99	-5.86	QP
2	0.1500	36.80	10.40	47.20	55.99	-8.79	AVG
3	0.2220	38.06	10.37	48.43	62.74	-14.31	QP
4	0.2220	28.79	10.37	39.16	52.74	-13.58	AVG
5	0.2940	35.45	10.30	45.75	60.41	-14.66	QP
6	0.2940	25.15	10.30	35.45	50.41	-14.96	AVG
7	0.6620	26.17	10.20	36.37	56.00	-19.63	QP
8	0.6620	20.66	10.20	30.86	46.00	-15.14	AVG
9	6.4580	32.53	10.38	42.91	50.00	-7.09	AVG
10	7.1140	37.84	10.38	48.22	60.00	-11.78	QP
11	15.4060	29.39	10.23	39.62	50.00	-10.38	AVG
12	15.8460	37.88	10.25	48.13	60.00	-11.87	QP



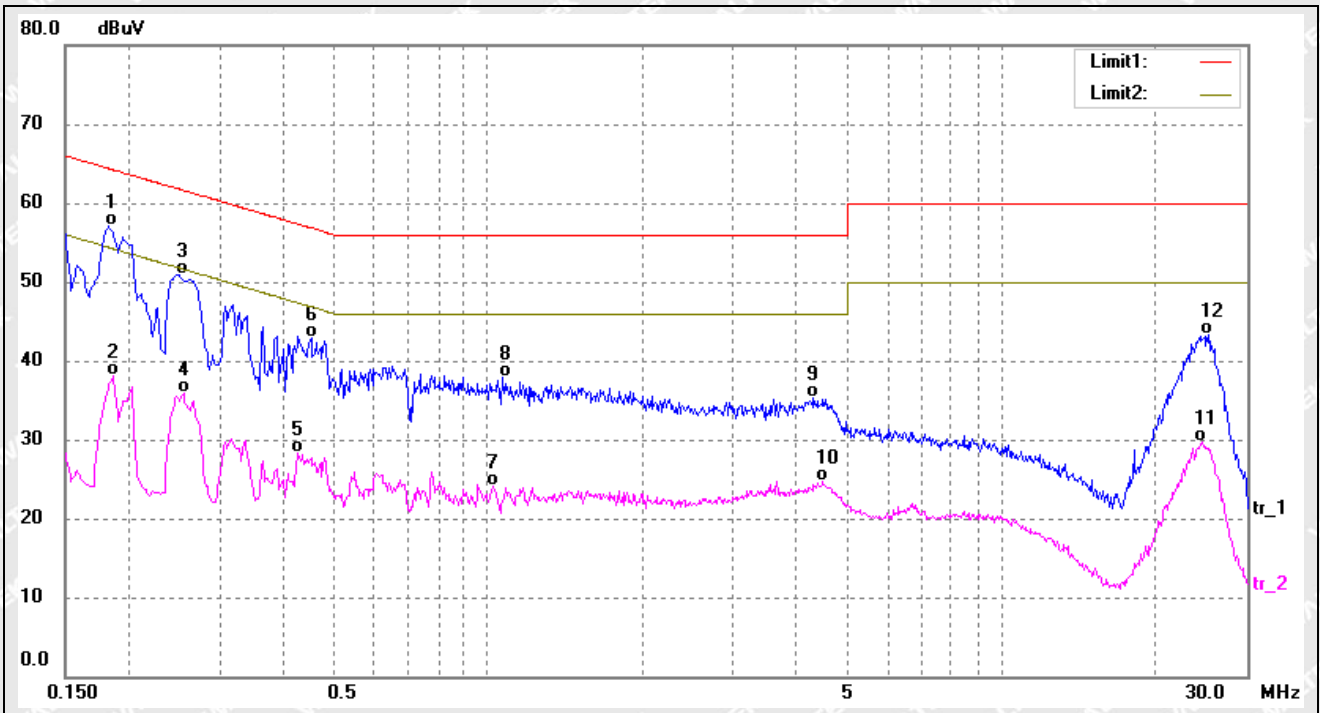
Test mode:	TM6	Polarity:	Line
------------	-----	-----------	------



No.	Frequency (MHz)	Reading (dBuV)	Correct (dB)	Result (dBuV)	Limit (dBuV)	Margin (dB)	Detector
1*	0.1819	50.72	10.39	61.11	64.39	-3.28	QP
2	0.1819	31.40	10.39	41.79	54.39	-12.60	AVG
3	0.2420	43.25	10.35	53.60	62.02	-8.42	QP
4	0.2420	28.34	10.35	38.69	52.02	-13.33	AVG
5	0.4300	16.73	10.25	26.98	47.25	-20.27	AVG
6	0.4420	31.38	10.25	41.63	57.02	-15.39	QP
7	0.7780	14.84	10.18	25.02	46.00	-20.98	AVG
8	0.9020	26.85	10.15	37.00	56.00	-19.00	QP
9	4.2460	23.89	10.37	34.26	56.00	-21.74	QP
10	4.4820	13.20	10.37	23.57	46.00	-22.43	AVG
11	24.4740	33.87	10.30	44.17	60.00	-15.83	QP
12	25.0060	18.88	10.29	29.17	50.00	-20.83	AVG



Test mode:	TM6	Polarity:	Neutral
------------	-----	-----------	---------



No.	Frequency (MHz)	Reading (dBuV)	Correct (dB)	Result (dBuV)	Limit (dBuV)	Margin (dB)	Detector
1*	0.1819	46.68	10.39	57.07	64.39	-7.32	QP
2	0.1860	27.72	10.40	38.12	54.21	-16.09	AVG
3	0.2500	40.52	10.34	50.86	61.75	-10.89	QP
4	0.2540	25.48	10.34	35.82	51.62	-15.80	AVG
5	0.4260	18.15	10.25	28.40	47.33	-18.93	AVG
6	0.4500	32.74	10.25	42.99	56.87	-13.88	QP
7	1.0220	13.89	10.14	24.03	46.00	-21.97	AVG
8	1.0700	27.68	10.16	37.84	56.00	-18.16	QP
9	4.3020	24.92	10.37	35.29	56.00	-20.71	QP
10	4.4780	14.36	10.37	24.73	46.00	-21.27	AVG
11	24.6220	19.37	10.30	29.67	50.00	-20.33	AVG
12	25.2979	33.11	10.29	43.40	60.00	-16.60	QP



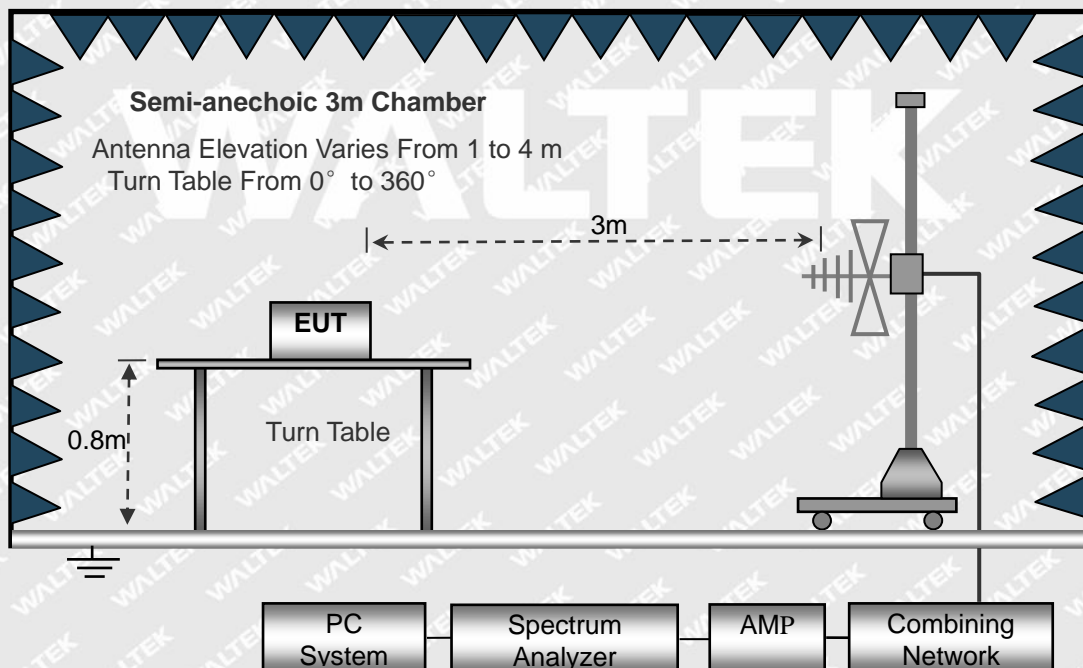
4. Radiated Emission

4.1 Measurement Uncertainty

Base on NIS 81, The Treatment of Uncertainty in EMC Measurements, the best estimate of the uncertainty of any radiation emissions measurement:

Measurement uncertainty		
Parameter	Conditions	Uncertainty
Radiated Emissions	Radiated	30-200MHz $\pm 4.52\text{dB}$
		0.2-1GHz $\pm 5.56\text{dB}$
		1-6GHz $\pm 3.84\text{dB}$
		6-18GHz $\pm 3.92\text{dB}$

4.2 Basic Test Setup Block Diagram





4.3 Corrected Amplitude & Margin Calculation

The Corrected Amplitude is calculated by adding the Antenna Factor and the Cable Factor, and subtracting the Amplifier Gain from the Amplitude reading. The basic equation is as follows:

$$\text{Corr. Ampl.} = \text{Indicated Reading} + \text{Correct Correct} = \text{Ant. Factor} + \text{Cable Loss} - \text{Ampl. Gain}$$

The "**Margin**" column of the following data tables indicates the degree of compliance with the applicable limit. For example, a margin of -6dB μ V means the emission is 6dB μ V below the maximum limit for Class B device. The equation for margin calculation is as follows:

$$\text{Margin} = \text{Corr. Ampl.} - \text{CISPR 11 Class B Limit}$$

4.4 Environmental Conditions

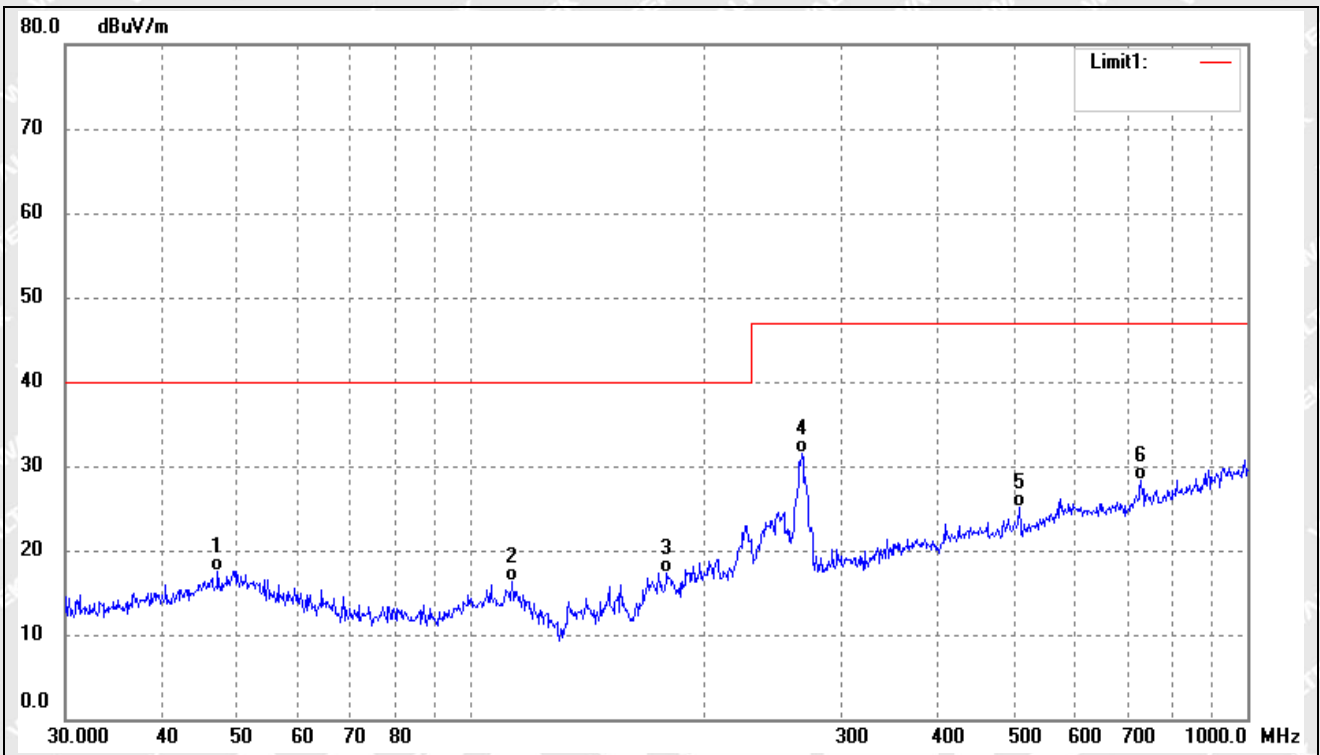
Temperature:	23.5 °C
Relative Humidity:	54 %
ATM Pressure:	997 mbar

4.5 Summary of Test Results

Please find the results below:



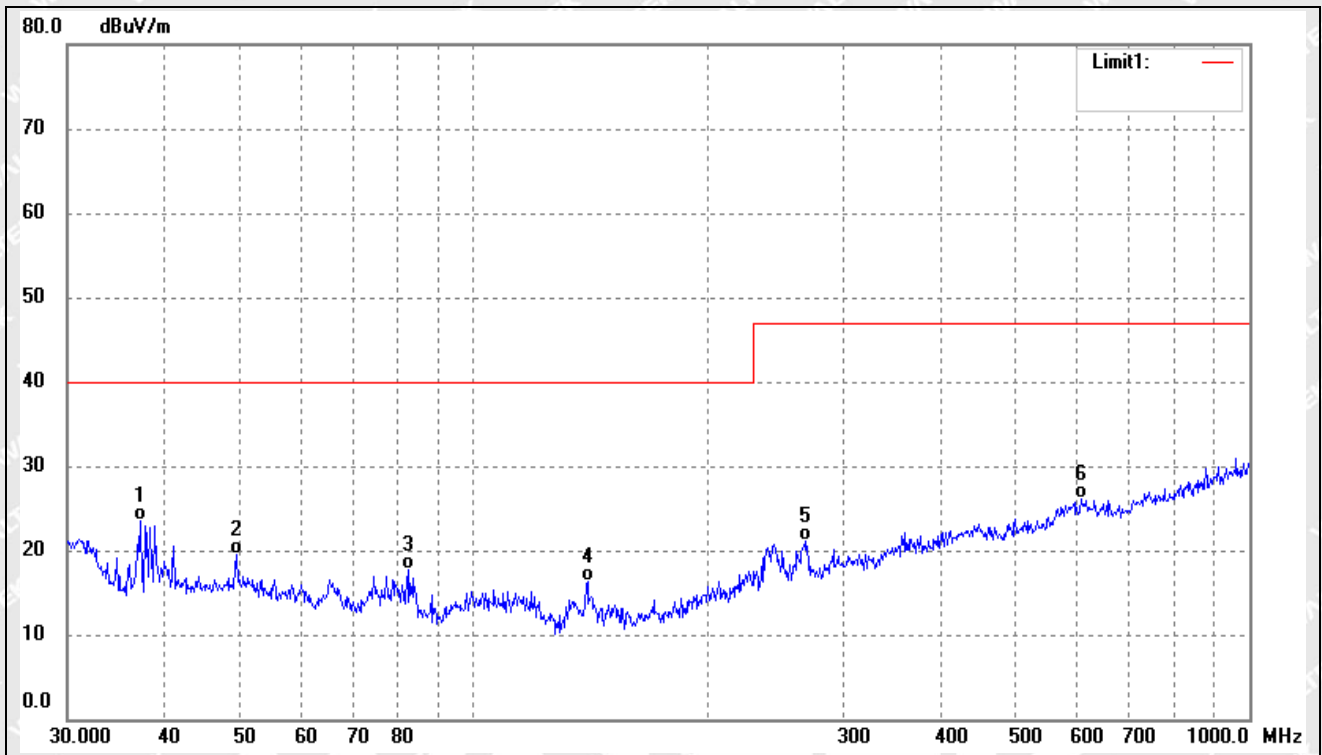
Test mode:	TM1	Polarity:	Horizontal
------------	-----	-----------	------------



No.	Frequency (MHz)	Reading (dBuV/m)	Correct (dB/m)	Result (dBuV/m)	Limit (dBuV/m)	Margin (dB)	Degree ()	Height (cm)	Remark
1	47.1599	27.96	-10.40	17.56	40.00	-22.44	218	100	QP
2	112.9196	28.84	-12.46	16.38	40.00	-23.62	100	100	QP
3	178.7584	30.68	-13.36	17.32	40.00	-22.68	227	100	QP
4	266.6089	40.40	-8.91	31.49	47.00	-15.51	103	100	QP
5	508.2582	29.56	-4.46	25.10	47.00	-21.90	105	100	QP
6	729.3583	29.49	-1.15	28.34	47.00	-18.66	334	100	QP



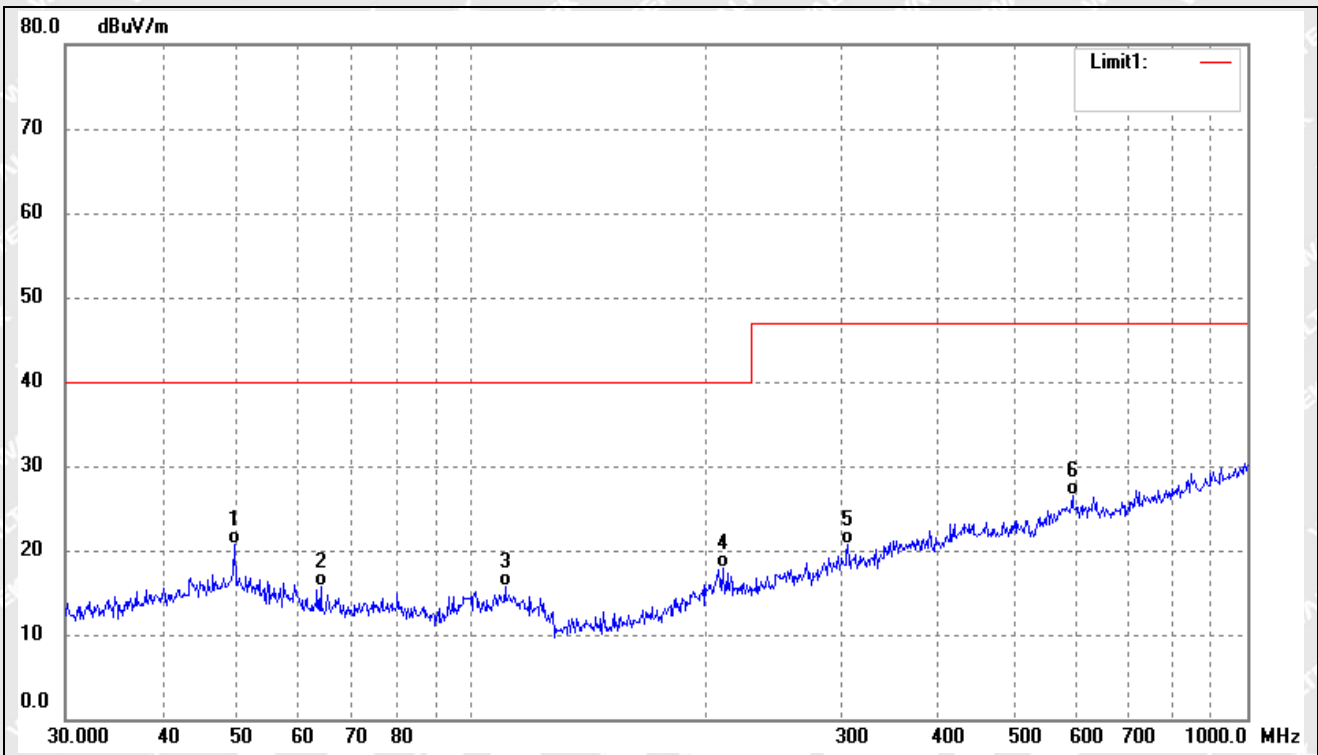
Test mode:	TM1	Polarity:	Vertical
------------	-----	-----------	----------



No.	Frequency (MHz)	Reading (dBuV/m)	Correct (dB/m)	Result (dBuV/m)	Limit (dBuV/m)	Margin (dB)	Degree ()	Height (cm)	Remark
1	37.2855	35.66	-12.22	23.44	40.00	-16.56	213	100	QP
2	49.5328	29.72	-10.23	19.49	40.00	-20.51	100	100	QP
3	82.6482	31.92	-14.29	17.63	40.00	-22.37	199	100	QP
4	140.3421	30.72	-14.50	16.22	40.00	-23.78	97	100	QP
5	267.5455	30.02	-8.88	21.14	47.00	-25.86	135	100	QP
6	607.7867	28.40	-2.31	26.09	47.00	-20.91	204	100	QP



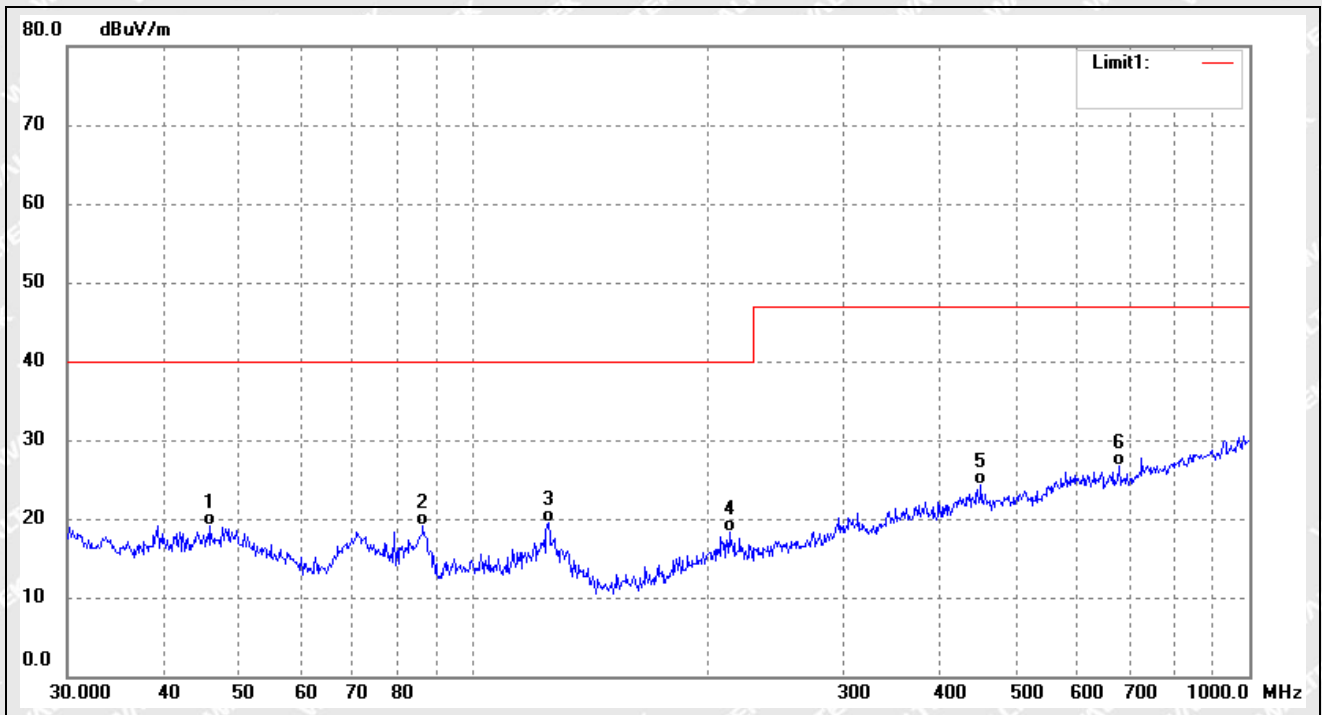
Test mode:	TM2	Polarity:	Horizontal
------------	-----	-----------	------------



No.	Frequency (MHz)	Reading (dBuV/m)	Correct (dB/m)	Result (dBuV/m)	Limit (dBuV/m)	Margin (dB)	Degree ()	Height (cm)	Remark
1	49.5328	30.84	-10.23	20.61	40.00	-19.39	76	100	QP
2	63.9828	28.61	-12.89	15.72	40.00	-24.28	317	100	QP
3	110.5687	28.00	-12.21	15.79	40.00	-24.21	68	100	QP
4	210.7860	28.92	-11.06	17.86	40.00	-22.14	240	100	QP
5	305.6800	27.99	-7.27	20.72	47.00	-26.28	231	100	QP
6	595.1329	28.85	-2.33	26.52	47.00	-20.48	211	100	QP



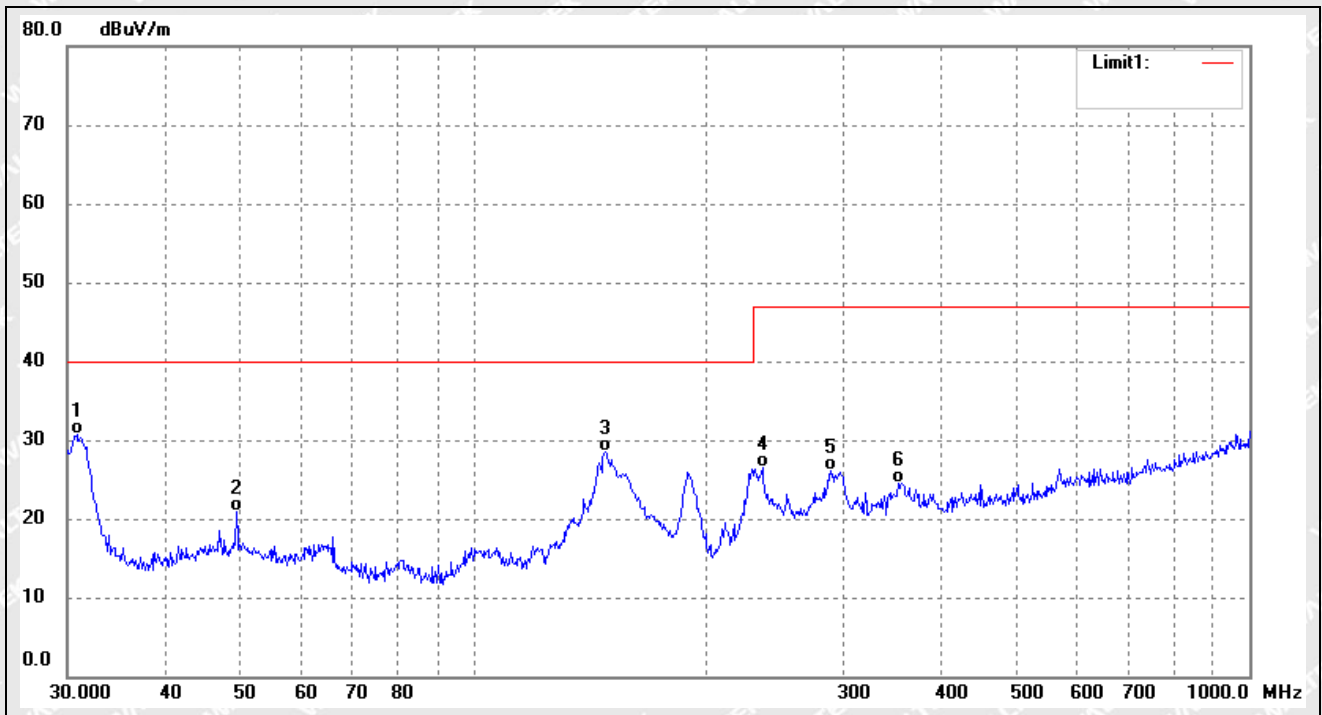
Test mode:	TM2	Polarity:	Vertical
------------	-----	-----------	----------



No.	Frequency (MHz)	Reading (dBuV/m)	Correct (dB/m)	Result (dBuV/m)	Limit (dBuV/m)	Margin (dB)	Degree ()	Height (cm)	Remark
1	45.8553	29.51	-10.50	19.01	40.00	-20.99	346	100	QP
2	86.2001	33.53	-14.44	19.09	40.00	-20.91	340	100	QP
3	125.0066	34.13	-14.54	19.59	40.00	-20.41	88	100	QP
4	213.7634	29.40	-11.01	18.39	40.00	-21.61	329	100	QP
5	451.1350	28.90	-4.62	24.28	47.00	-22.72	158	100	QP
6	679.9600	29.07	-2.43	26.64	47.00	-20.36	105	100	QP



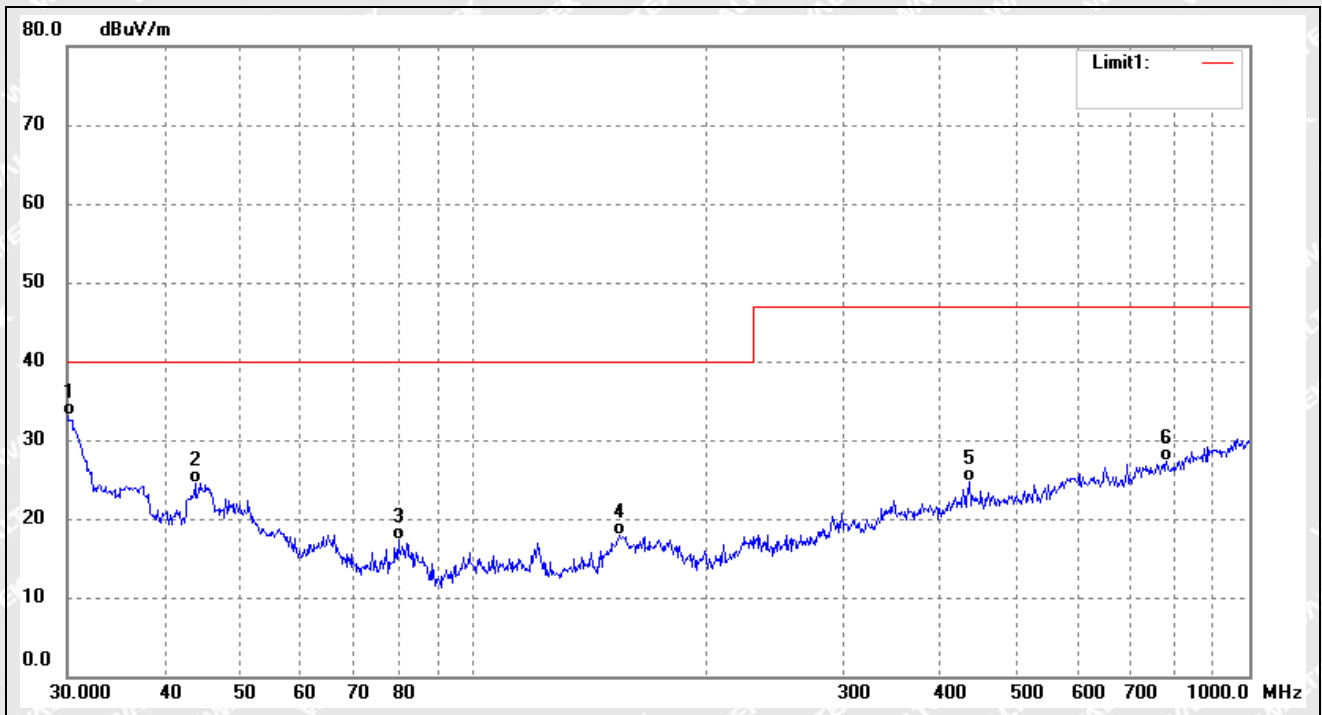
Test mode:	TM3	Polarity:	Horizontal
------------	-----	-----------	------------



No.	Frequency (MHz)	Reading (dBuV/m)	Correct (dB/m)	Result (dBuV/m)	Limit (dBuV/m)	Margin (dB)	Degree ()	Height (cm)	Remark
1	30.8535	44.29	-13.67	30.62	40.00	-9.38	107	100	QP
2	49.5328	31.23	-10.23	21.00	40.00	-19.00	169	100	QP
3	147.9214	43.25	-14.77	28.48	40.00	-11.52	121	100	QP
4	235.8164	36.56	-10.13	26.43	47.00	-20.57	137	100	QP
5	289.0021	33.99	-7.88	26.11	47.00	-20.89	211	100	QP
6	352.9433	30.65	-6.08	24.57	47.00	-22.43	255	100	QP



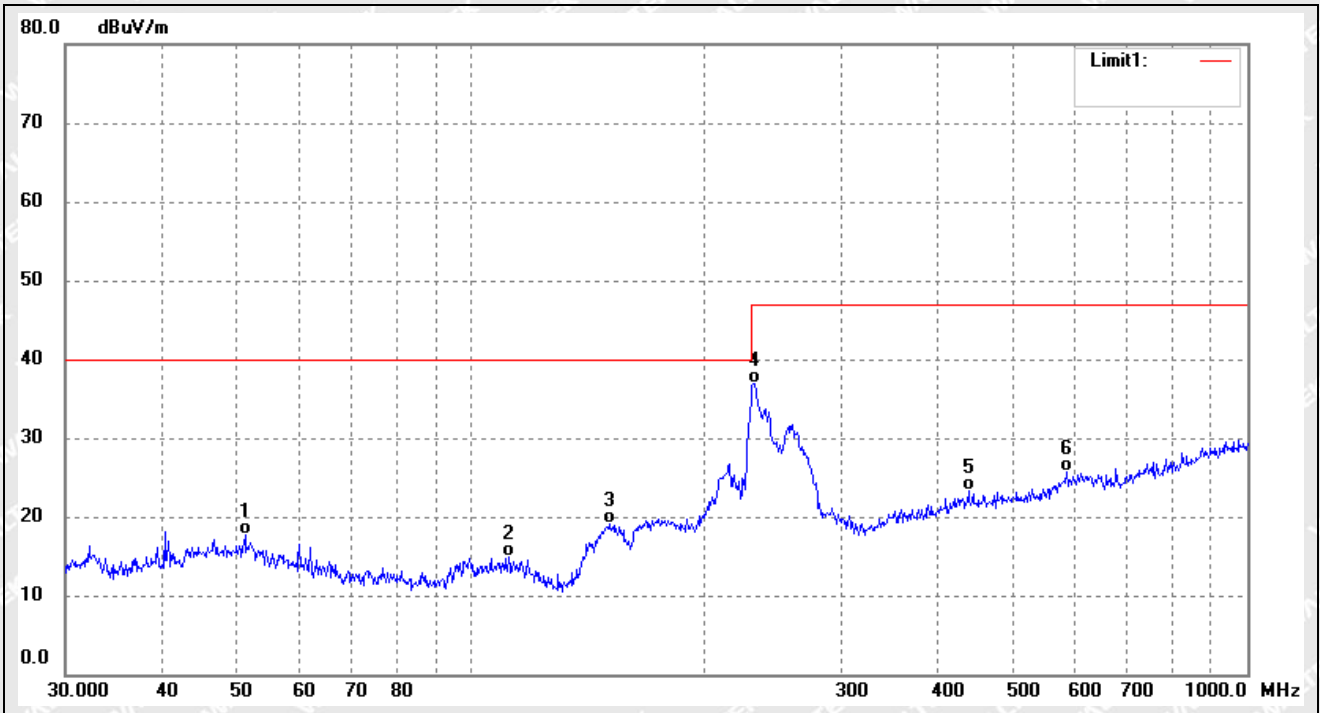
Test mode:	TM3	Polarity:	Vertical
------------	-----	-----------	----------



No.	Frequency (MHz)	Reading (dBuV/m)	Correct (dB/m)	Result (dBuV/m)	Limit (dBuV/m)	Margin (dB)	Degree ()	Height (cm)	Remark
1	30.0000	46.96	-13.88	33.08	40.00	-6.92	78	100	QP
2	43.8119	35.38	-10.84	24.54	40.00	-15.46	120	100	QP
3	80.0806	31.44	-14.17	17.27	40.00	-22.73	77	100	QP
4	154.2786	32.46	-14.62	17.84	40.00	-22.16	116	100	QP
5	435.5898	29.08	-4.40	24.68	47.00	-22.32	92	100	QP
6	782.3453	27.85	-0.55	27.30	47.00	-19.70	189	100	QP



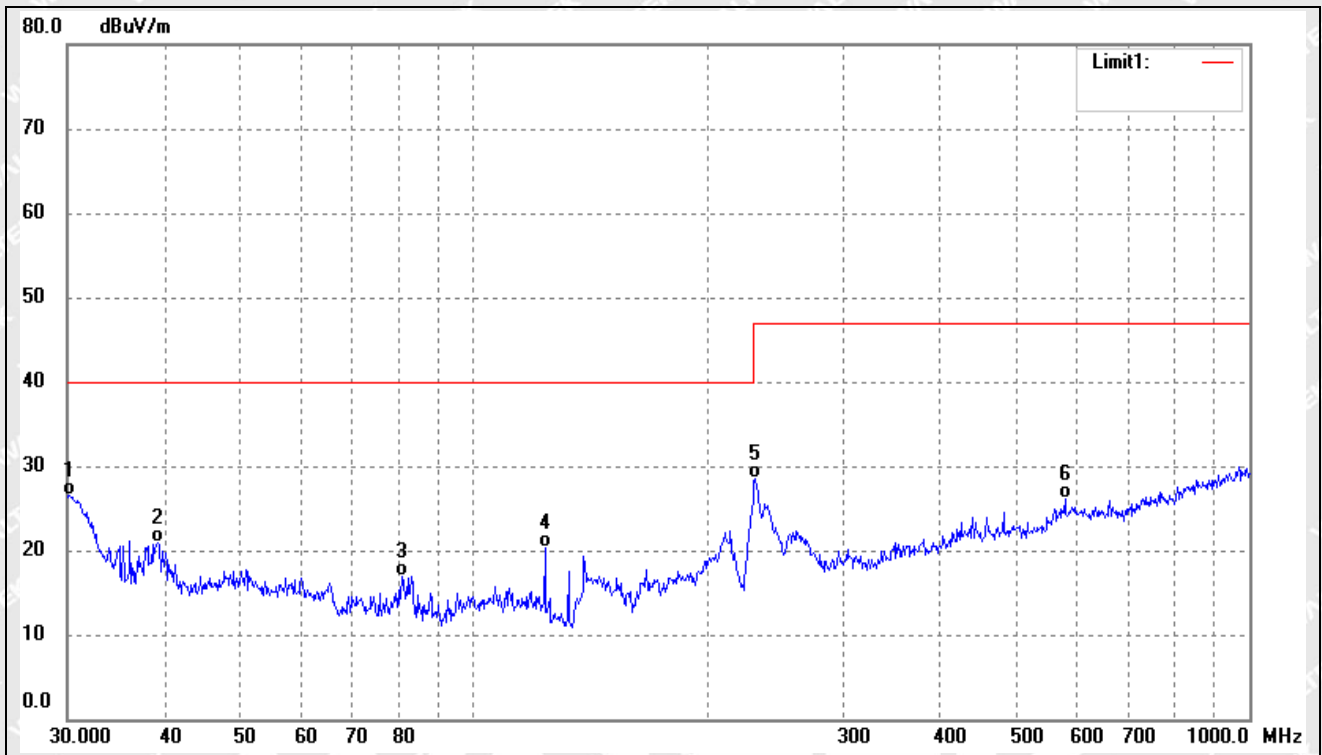
Test mode:	TM4	Polarity:	Horizontal
------------	-----	-----------	------------



No.	Frequency (MHz)	Reading (dBuV/m)	Correct (dB/m)	Result (dBuV/m)	Limit (dBuV/m)	Margin (dB)	Degree ()	Height (cm)	Remark
1	51.1208	28.16	-10.43	17.73	40.00	-22.27	167	100	QP
2	111.7378	27.25	-12.34	14.91	40.00	-25.09	151	100	QP
3	150.5378	33.88	-14.81	19.07	40.00	-20.93	127	100	QP
4	231.7178	47.29	-10.36	36.93	47.00	-10.07	143	100	QP
5	437.1197	27.64	-4.40	23.24	47.00	-23.76	140	100	QP
6	584.7894	28.06	-2.44	25.62	47.00	-21.38	115	100	QP



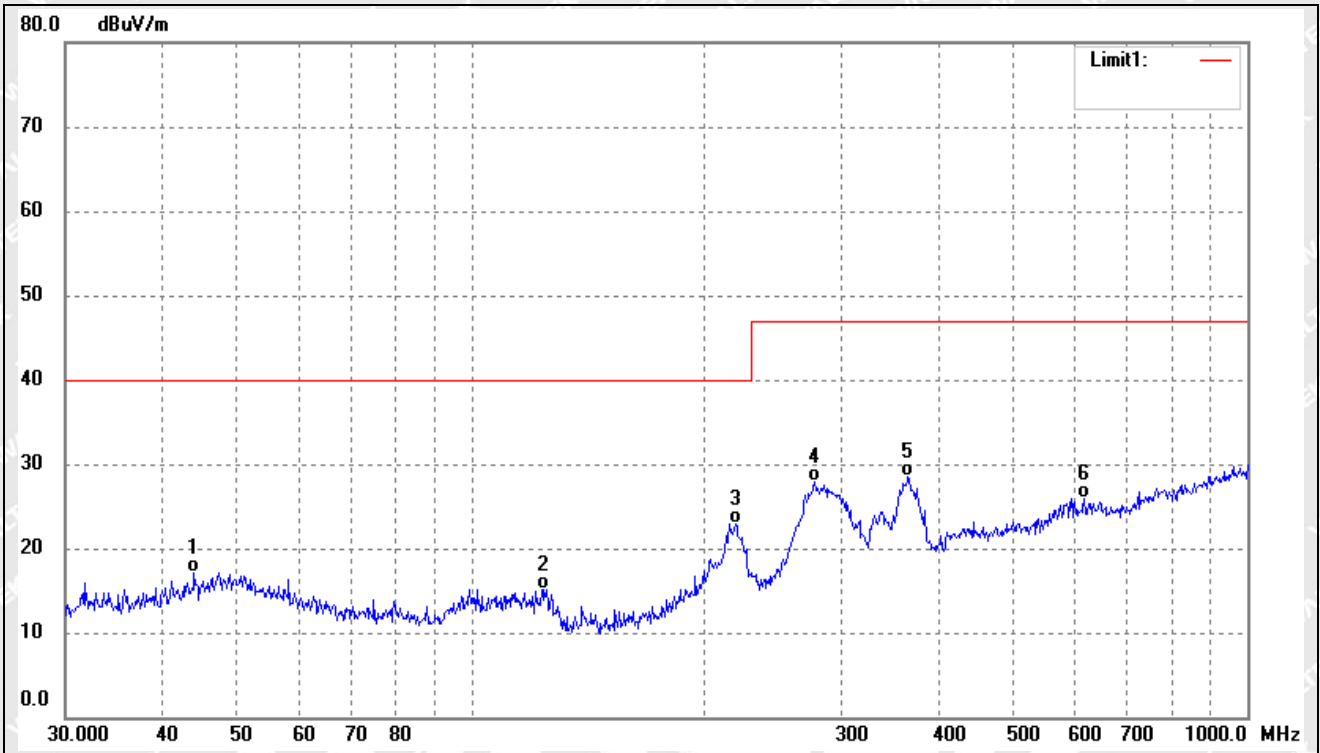
Test mode:	TM4	Polarity:	Vertical
------------	-----	-----------	----------



No.	Frequency (MHz)	Reading (dBuV/m)	Correct (dB/m)	Result (dBuV/m)	Limit (dBuV/m)	Margin (dB)	Degree ()	Height (cm)	Remark
1	30.2109	40.27	-13.83	26.44	40.00	-13.56	96	100	QP
2	39.2991	32.82	-11.88	20.94	40.00	-19.06	178	100	QP
3	80.9274	31.20	-14.22	16.98	40.00	-23.02	87	100	QP
4	123.6984	34.46	-14.21	20.25	40.00	-19.75	116	100	QP
5	230.9068	38.87	-10.42	28.45	47.00	-18.55	320	100	QP
6	578.6698	28.63	-2.50	26.13	47.00	-20.87	146	100	QP



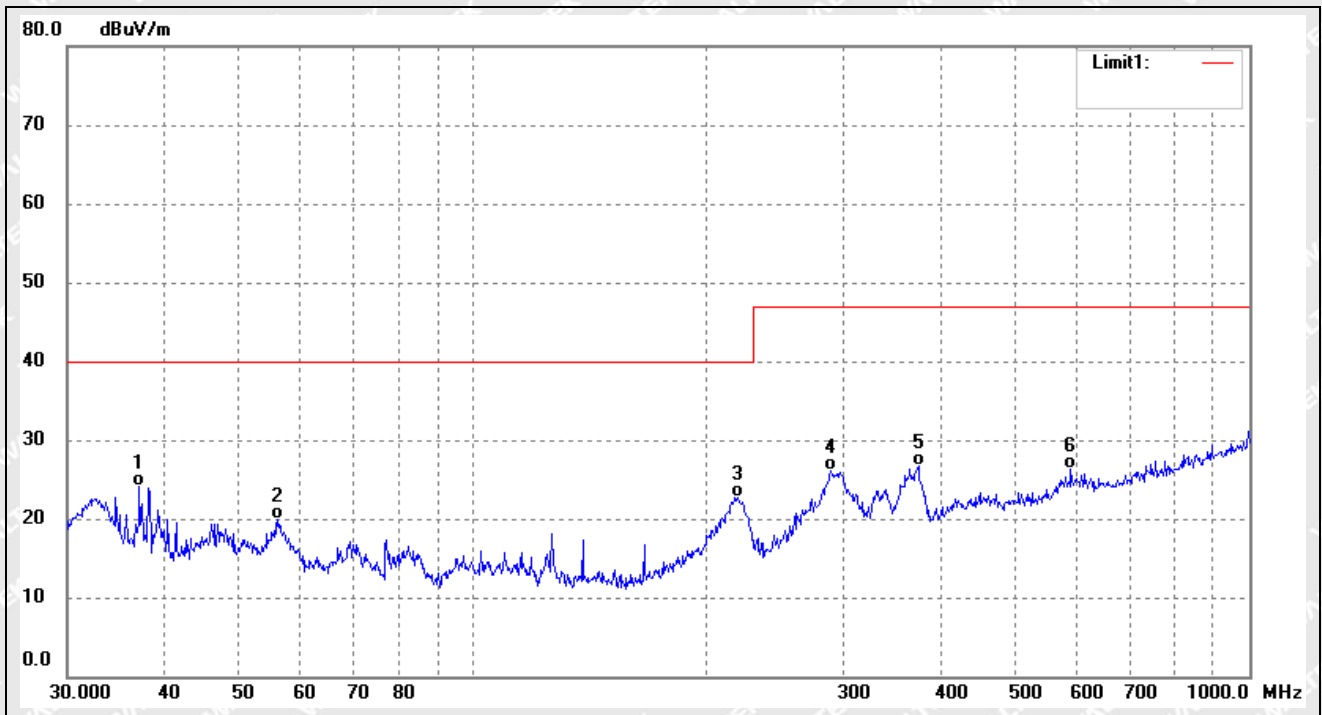
Test mode:	TM5	Polarity:	Horizontal
------------	-----	-----------	------------



No.	Frequency (MHz)	Reading (dBuV/m)	Correct (dB/m)	Result (dBuV/m)	Limit (dBuV/m)	Margin (dB)	Degree ()	Height (cm)	Remark
1	43.9658	27.89	-10.81	17.08	40.00	-22.92	100	100	QP
2	124.1330	29.42	-14.31	15.11	40.00	-24.89	179	100	QP
3	219.0753	33.83	-10.89	22.94	40.00	-17.06	81	100	QP
4	277.0935	36.42	-8.59	27.83	47.00	-19.17	90	100	QP
5	365.5391	34.35	-5.86	28.49	47.00	-18.51	150	100	QP
6	616.3718	28.32	-2.35	25.97	47.00	-21.03	113	100	QP



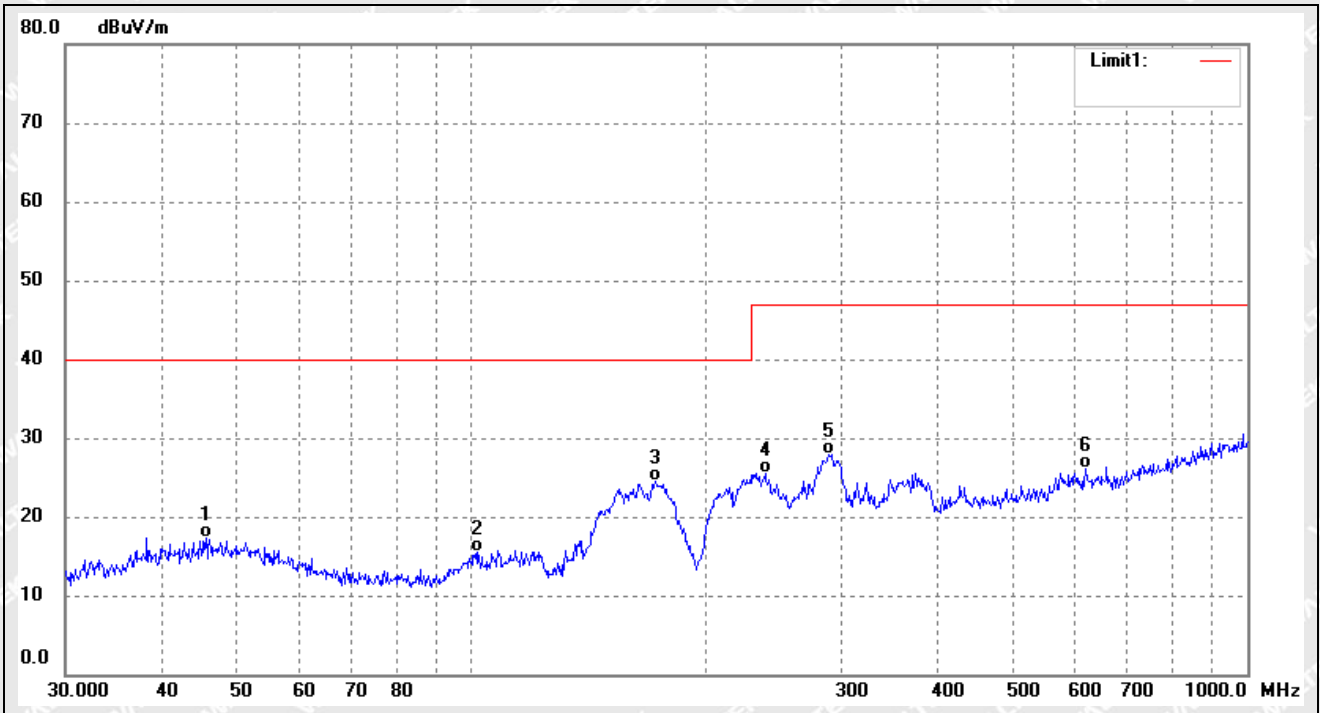
Test mode:	TM5	Polarity:	Vertical
------------	-----	-----------	----------



No.	Frequency (MHz)	Reading (dBuV/m)	Correct (dB/m)	Result (dBuV/m)	Limit (dBuV/m)	Margin (dB)	Degree ()	Height (cm)	Remark
1	37.1550	36.43	-12.25	24.18	40.00	-15.82	69	100	QP
2	56.0007	31.45	-11.49	19.96	40.00	-20.04	142	100	QP
3	219.0753	33.62	-10.89	22.73	40.00	-17.27	50	100	QP
4	289.0021	33.93	-7.88	26.05	47.00	-20.95	104	100	QP
5	374.6225	32.32	-5.69	26.63	47.00	-20.37	103	100	QP
6	588.9051	28.63	-2.40	26.23	47.00	-20.77	328	100	QP



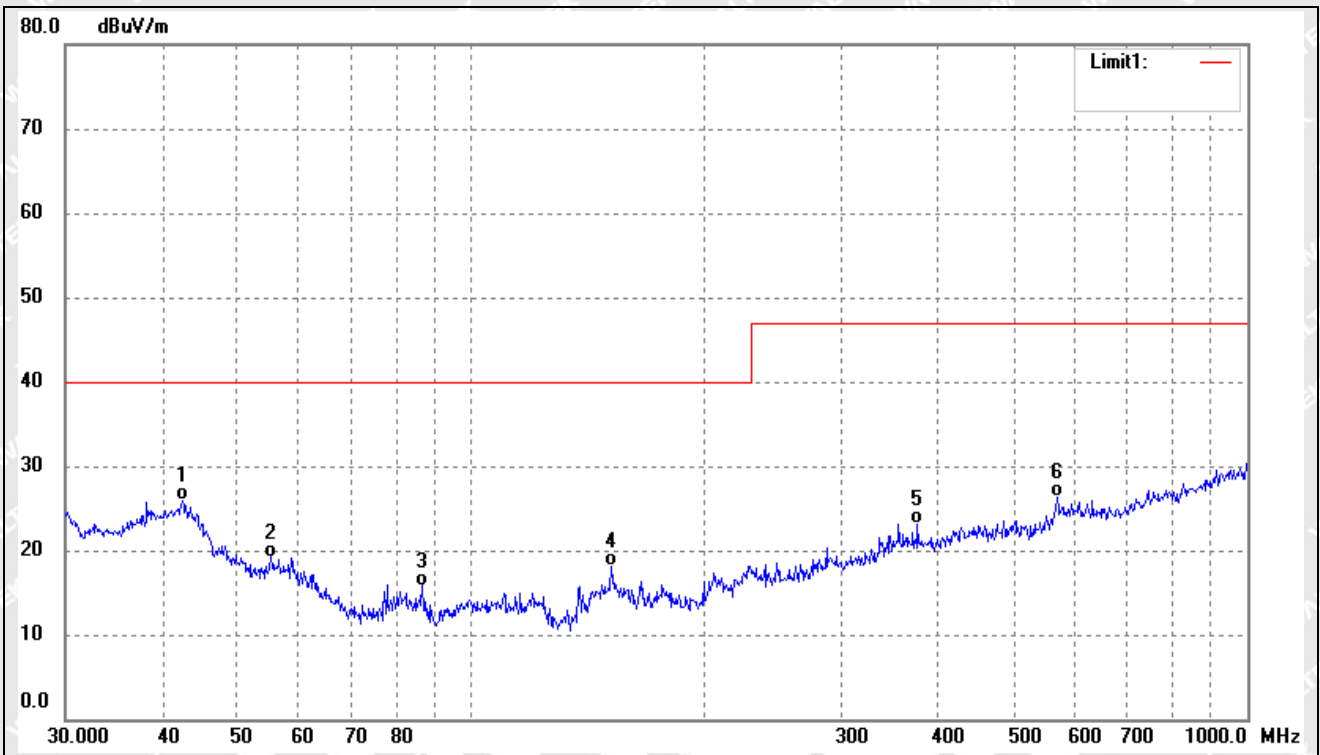
Test mode:	TM6	Polarity:	Horizontal
------------	-----	-----------	------------



No.	Frequency (MHz)	Reading (dBuV/m)	Correct (dB/m)	Result (dBuV/m)	Limit (dBuV/m)	Margin (dB)	Degree ()	Height (cm)	Remark
1	45.5348	27.91	-10.53	17.38	40.00	-22.62	196	100	QP
2	102.0014	27.80	-12.33	15.47	40.00	-24.53	115	100	QP
3	172.5988	38.18	-13.58	24.60	40.00	-15.40	112	100	QP
4	239.1473	35.51	-9.94	25.57	47.00	-21.43	146	100	QP
5	289.0021	35.83	-7.88	27.95	47.00	-19.05	191	100	QP
6	618.5369	28.48	-2.36	26.12	47.00	-20.88	120	100	QP



Test mode:	TM6	Polarity:	Vertical
------------	-----	-----------	----------



No.	Frequency (MHz)	Reading (dBuV/m)	Correct (dB/m)	Result (dBuV/m)	Limit (dBuV/m)	Margin (dB)	Degree ()	Height (cm)	Remark
1	42.4508	37.04	-11.17	25.87	40.00	-14.13	100	100	QP
2	55.2207	30.51	-11.31	19.20	40.00	-20.80	163	100	QP
3	86.5029	30.26	-14.46	15.80	40.00	-24.20	69	100	QP
4	151.5972	32.90	-14.77	18.13	40.00	-21.87	95	100	QP
5	375.9385	28.88	-5.69	23.19	47.00	-23.81	104	100	QP
6	568.6127	29.12	-2.87	26.25	47.00	-20.75	324	100	QP



5. Harmonic Current Emissions

5.1 Test Procedure

Test is conducted under the description of IEC 61000-3-2.

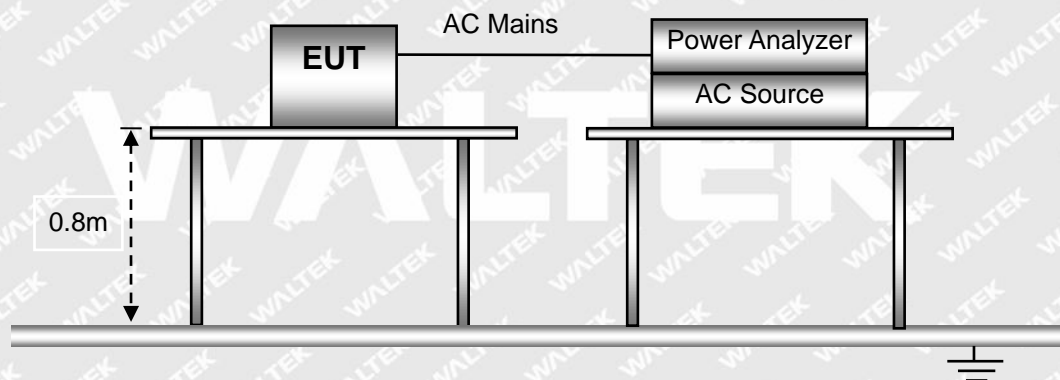
5.2 Test Standards

IEC 61000-3-2, Clause 7.2 Limits for Class A equipment.

5.3 Environmental Conditions

Temperature:	23.5 °C
Relative Humidity:	54 %
ATM Pressure:	997 mbar

5.4 Basic Test Setup Block Diagram



5.5 Harmonic Current Emissions Test Data

According to Clause 7 of IEC 61000-3-2, the rated power of the EUT is less than 75W, belong to 'equipment with a rated power of 75W or less', therefore 'limits are not specified in this edition of the standards'. It is deemed to fully fit the requirements of the standards.

Result: The EUT is compliance with the requirements of this section.



6. Voltage Fluctuation Flicker

6.1 Test Procedure

Test is conducted under the description of IEC 61000-3-3.

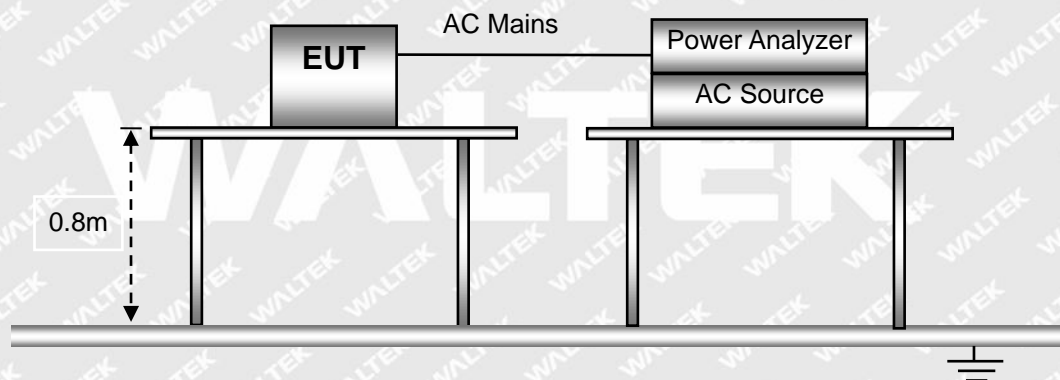
6.2 Test Standards

IEC 61000-3-3, Limit: Clause 5.

6.3 Environmental Conditions

Temperature:	23.5 °C
Relative Humidity:	54 %
ATM Pressure:	997 mbar

6.4 Basic Test Setup Block Diagram



6.5 Voltage Fluctuation and Flicker Test Data



Test mode:	TM1
------------	-----

Flicker Test Summary per IEC61000-3-3:2013+AMD2:2021 (Run time)

Comment: TM1

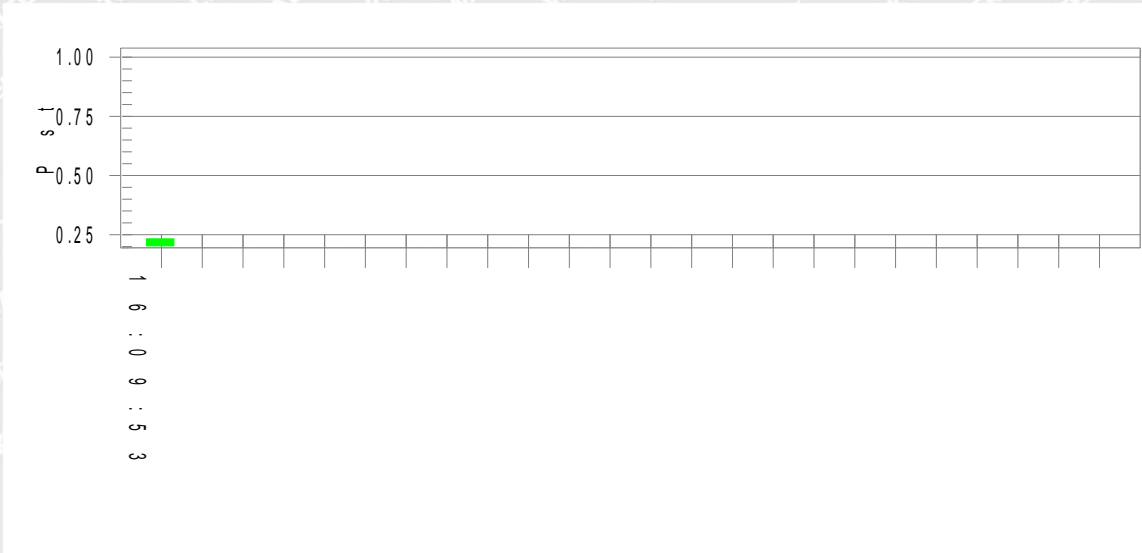
Customer: Customer information

Test Result: Pass

Status: Test Completed

Pst and limit line

European Limits



Plt and limit line



Parameter values recorded during the test:

Vrms at the end of test (Volt): 230.07

Highest dt (%):

Test limit (%):

T-max (mS): 0

Test limit (mS): 500.0 Pass

Highest dc (%): 0.00

Test limit (%): 3.30 Pass

Highest dmax (%): 0.00

Test limit (%): 4.00 Pass

Highest Pst (10 min. period): 0.233

Test limit: 1.000 Pass

Highest Plt (2 hr. period): 0.102

Test limit: 0.650 Pass



Test mode:	TM2
------------	-----

Flicker Test Summary per IEC61000-3-3:2013+AMD2:2021 (Run time)

Comment: TM2

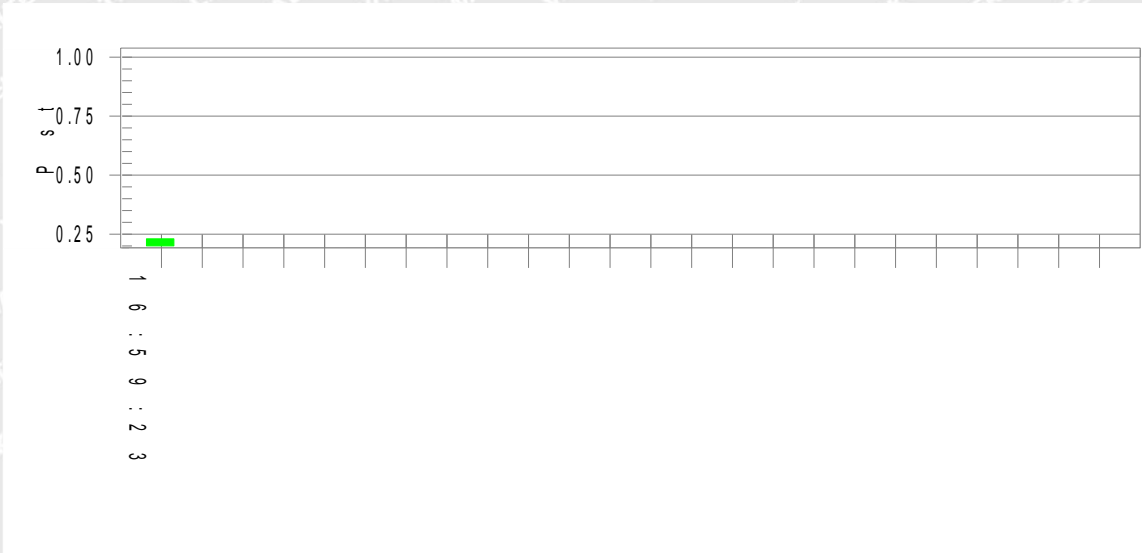
Customer: Customer information

Test Result: Pass

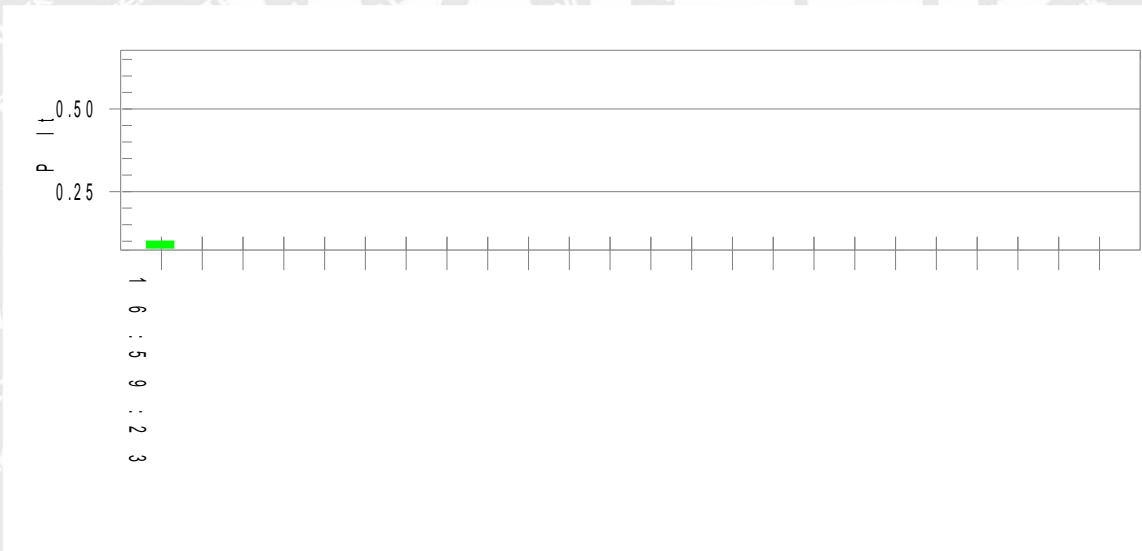
Status: Test Completed

Pst and limit line

European Limits



Plt and limit line



Parameter values recorded during the test:

Vrms at the end of test (Volt): 230.05

Highest dt (%):

Test limit (%):

T-max (mS): 0

Test limit (mS): 500.0 Pass

Highest dc (%): 0.00

Test limit (%): 3.30 Pass

Highest dmax (%): 0.00

Test limit (%): 4.00 Pass

Highest Pst (10 min. period): 0.230

Test limit: 1.000 Pass

Highest Plt (2 hr. period): 0.101

Test limit: 0.650 Pass



Test mode:	TM3
------------	-----

Flicker Test Summary per IEC61000-3-3:2013+AMD2:2021 (Run time)

Comment: TM3

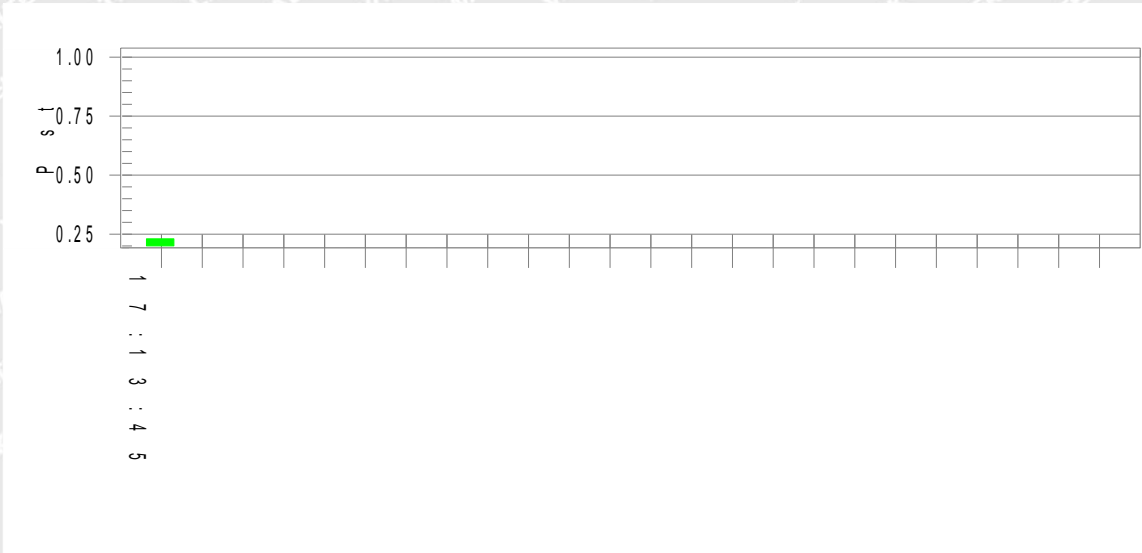
Customer: Customer information

Test Result: Pass

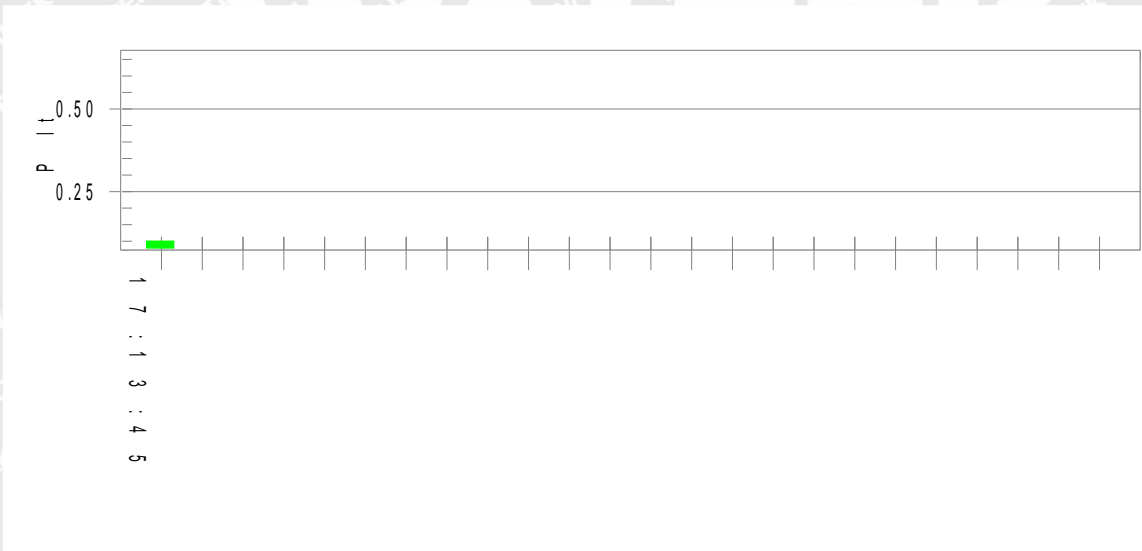
Status: Test Completed

Pst_i and limit line

European Limits



Plt and limit line



Parameter values recorded during the test:

Vrms at the end of test (Volt): 230.03

Highest dt (%):

Test limit (%):

T-max (mS): 0

Test limit (mS): 500.0 Pass

Highest dc (%): 0.00

Test limit (%): 3.30 Pass

Highest dmax (%): 0.00

Test limit (%): 4.00 Pass

Highest Pst (10 min. period): 0.230

Test limit: 1.000 Pass

Highest Plt (2 hr. period): 0.101

Test limit: 0.650 Pass



7. Electrostatic Discharges (ESD)

7.1 Test Procedure

Test is conducted under the description of IEC 61000-4-2.

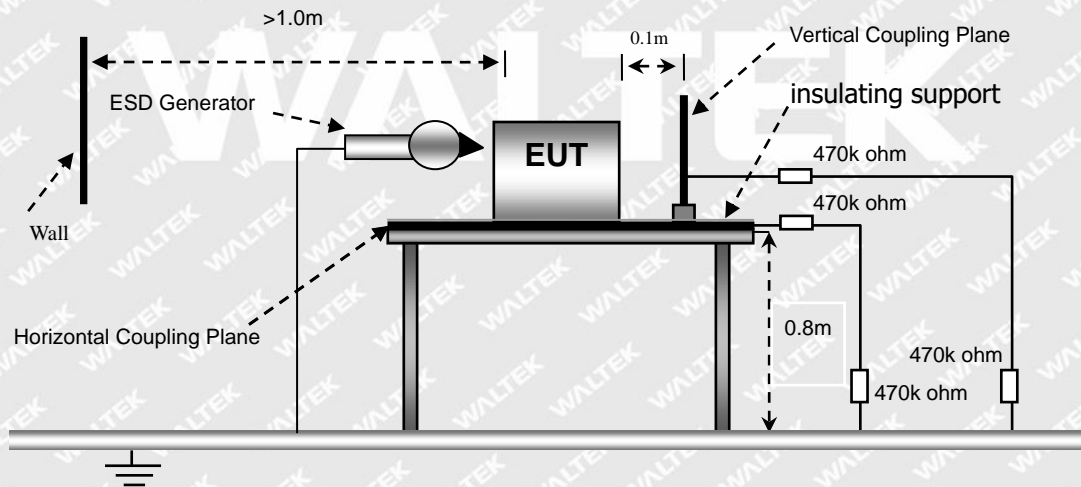
7.2 Test Performance

Performance Criterion: B

7.3 Environmental Conditions

Temperature:	23.5 °C
Relative Humidity:	54 %
ATM Pressure:	997 mbar

7.4 Basic Test Setup Block Diagram





7.5 Electrostatic Discharge Immunity Test Data

Table 1: Electrostatic Discharge Immunity (Air Discharge)

IEC 61000-4-2	Test Voltage (kV)											
Test Points	-2	+2	-4	+4	-6	+6	-8	+8	-15	+15	-20	+20
Shell edge crack	A	A	A	A	A	A	A	A	A	A	A	A

Table 2: Electrostatic Discharge Immunity (Direct Contact)

IEC 61000-4-2	Test Voltage (kV)											
Test Points	-2	+2	-4	+4	-6	+6	-8	+8	-15	+15	-20	+20
/	/	/	/	/	/	/	/	/	/	/	/	/

Table 3: Electrostatic Discharge Immunity (Indirect Contact HCP & VCP)

IEC 61000-4-2	Test Voltage (kV)											
Test Points	-2	+2	-4	+4	-6	+6	-8	+8	-10	+10	-20	+20
HCP (6 Sides)	A	A	A	A	A	A	A	A	A	A	/	/
VCP (4 Sides)	A	A	A	A	A	A	A	A	A	A	/	/

Test Result: Pass

8. Continuous RF Electromagnetic Field Disturbances (RS)

8.1 Test Procedure

Test is conducted under the description of IEC 61000-4-3.

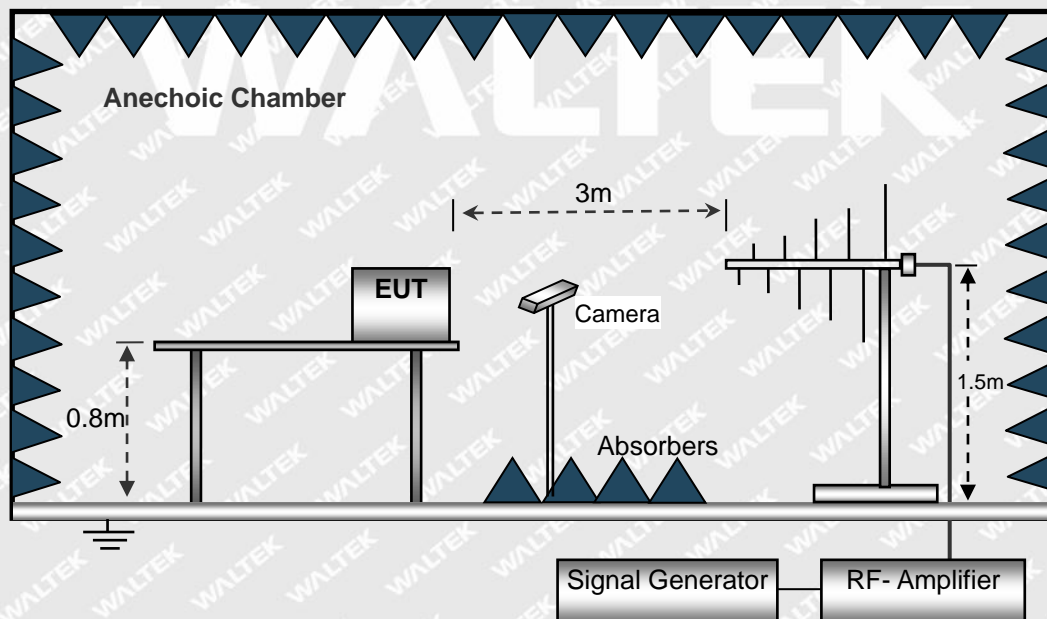
8.2 Test Performance

Performance Criterion: A

8.3 Environmental Conditions

Temperature:	23.5 °C
Relative Humidity:	54 %
ATM Pressure:	997 mbar

8.4 Basic Test Setup Block Diagram





8.5 Continuous Radiated Disturbances Test Data

Frequency step: 1% of fundamental

Dwell time: 1 second

Modulation: AM by 1kHz sine wave with 80% modulation depth

Frequency Range(MHz)	Field (V/m)	Front		Rear		Left Side		Right Side	
		VERT	HORI	VERT	HORI	VERT	HORI	VERT	HORI
80-2700	10	A	A	A	A	A	A	A	A

Test Result: Pass

WALTEK



9. Electrical Fast Transients (EFT)

9.1 Test Procedure

Test is conducted under the description of IEC 61000-4-4.

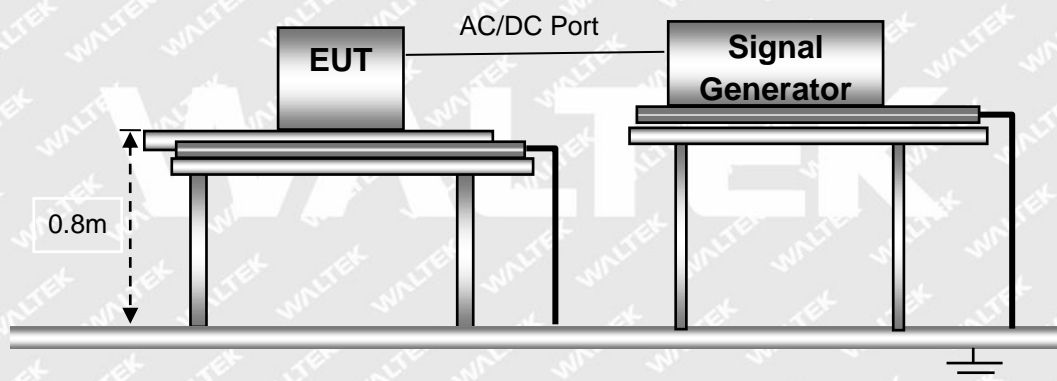
9.2 Test Performance

Performance Criterion: B

9.3 Environmental Conditions

Temperature:	23.5 °C
Relative Humidity:	54 %
ATM Pressure:	997 mbar

9.4 Basic Test Setup Block Diagram





9.5 Electrical Fast Transients Test Data

Repetition frequency 100 kHz

IEC 61000-4-4 Test Points		Test Voltage (kV)							
		+0.5	-0.5	+1.0	-1.0	+2.0	-2.0	+4.0	-4.0
Power Supply Power Port of EUT	L	/	/	/	/	A	A	A	A
	N	/	/	/	/	A	A	A	A
	PE	/	/	/	/	A	A	A	A
	L+N	/	/	/	/	A	A	A	A
	L+PE	/	/	/	/	A	A	A	A
	N+PE	/	/	/	/	A	A	A	A
	L+N+PE	/	/	/	/	A	A	A	A
Signal ports	RJ45	/	/	/	/	/	/	/	/

Test Result: Pass

WALTEK



10. Surges

10.1 Test Procedure

Test is conducted under the description of IEC 61000-4-5.

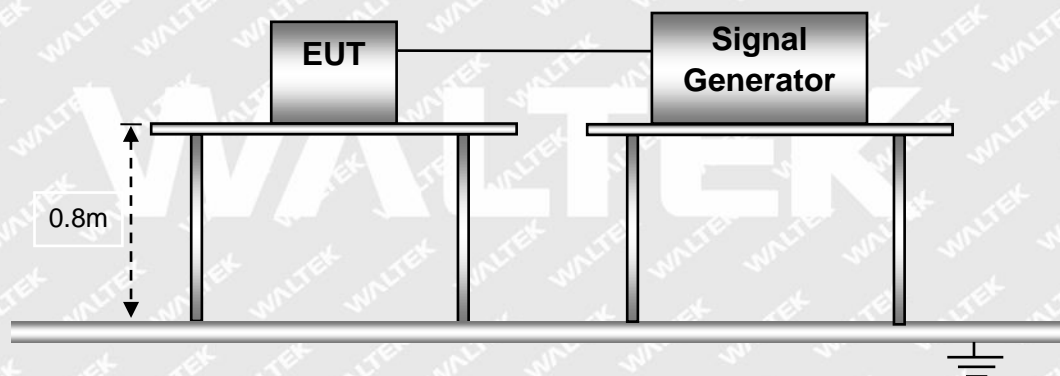
10.2 Test Performance

Performance Criterion: B

10.3 Environmental Conditions

Temperature:	23.5 °C
Relative Humidity:	54 %
ATM Pressure:	997 mbar

10.4 Basic Test Setup Block Diagram



10.5 Surge Test Data

Test Voltage (kV)	Poll	Path	Pass	Fail
0.5kV	±	L-N, L-PE, N-PE	A	/
1kV	±	L-N, L-PE, N-PE	A	/
2kV	±	L-N, L-PE, N-PE	A	/
4kV	±	L-PE, N-PE	A	/

Test Result: Pass



11. Continuous Induced RF Disturbances (C/S)

11.1 Test Procedure

Test is conducted under the description of IEC 61000-4-6.

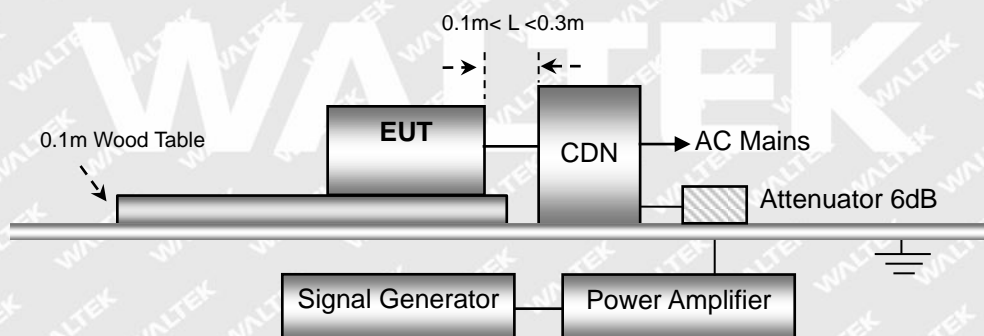
11.2 Test Performance

Performance Criterion: A

11.3 Environmental Conditions

Temperature:	23.5 °C
Relative Humidity:	54 %
ATM Pressure:	997 mbar

11.4 Basic Test Setup Block Diagram





11.5 Continuous Conducted Disturbances Test Data

Sweep frequency range: 0.15 MHz to 80 MHz

Frequency step: 1% of fundamental

Dwell time: 1 second

AC Port

Frequency MHz	Injected Position	Voltage level (e.m.f.)	Observations (Performance Criterion)	Result
0.15-80	AC Mains	1V	/	Pass
0.15-80	AC Mains	3V	A	Pass
0.15-80	AC Mains	10V	/	Pass

Test Result: Pass

WALTEK



12. Power-Frequency Magnetic Fields (PFMF)

12.1 Test Procedure

Test is conducted under the description of IEC 61000-4-8.

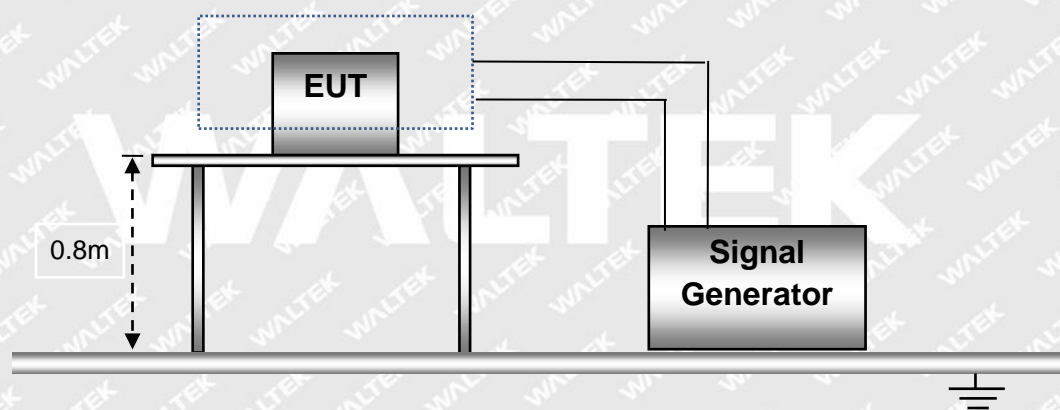
12.2 Test Performance

Performance Criterion: A

12.3 Environmental Conditions

Temperature:	23.5 °C
Relative Humidity:	54 %
ATM Pressure:	997 mbar

12.4 Basic Test Setup Block Diagram



12.5 Power-Frequency Magnetic Field Test Data

Level	Magnetic Field Strength (r.m.s) A/m	Frequency Hz	Induction Coil Position	Pass	Fail
1	1	50/60	X, Y, Z	/	/
2	3	50/60	X, Y, Z	/	/
3	10	50/60	X, Y, Z	/	/
4	30	50/60	X, Y, Z	A	/

Test Result: Pass



13. Voltage Dips and Interruptions

13.1 Test Procedure

Test is conducted under the description of IEC 61000-4-11.

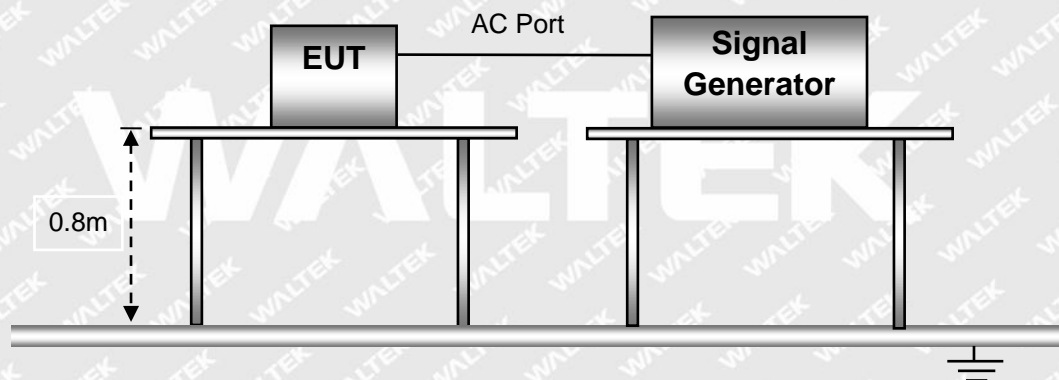
13.2 Test Performance

Performance Criterion: B/C

13.3 Environmental Conditions

Temperature:	23.5 °C
Relative Humidity:	54 %
ATM Pressure:	997 mbar

13.4 Basic Test Setup Block Diagram



13.5 Voltage Dips And Interruptions Test Data

U: Voltage dips in % U_T (U_T is rated voltage for the EUT)

T: Test duration




Level	U	T	Phase Angle	N	Pass	Fail
1	100%	10ms	0°/45°/90°/135°/180°,225°/270°/315°	3	A	/
2	100%	20ms	0°/45°/90°/135°/180°,225°/270°/315°	3	A	/
3	70%	500ms/600ms	0°/45°/90°/135°/180°,225°/270°/315°	3	B	/
4	100%	5000ms/6000ms	0°/45°/90°/135°/180°,225°/270°/315°	3	C	/

Test Result: Pass



EXHIBIT 1 - PRODUCT LABELING

Proposed CE Label Format

Power Supply
Model: GT*96180-*****, GT*96300-*****, and GT*91120-*****
Brand: 
Importer Name: XXX
Importer Address: XXX
1: GlobTek, Inc. 2: GlobTek (Suzhou) Co., Ltd
1: 186 Veterans Dr. Northvale, NJ 07647 USA
2: Building 4, No. 76, Jin Ling East Rd., Suzhou Industrial Park, Suzhou, JiangSu 215021, China
 

Specifications: Text is Black in color and is justified. Labels are printed in indelible ink on permanent adhesive backing or silk-screened onto the EUT or shall be affixed at a conspicuous location on the EUT. The 'CE' marking must be affixed to the EUT or to its data plate. Where this is not possible or not warranted on account of the nature of the apparatus, it must be affixed to the packaging, if any, and to the accompanying documents. The 'CE' marking must have a height of at least 5 mm. If the 'CE' marking is reduced or enlarged the proportions given in the above graduated drawing must be respected. The Importer name, address and Manufacturer name and address should indicate on marking label or packaging or in a document accompanying.

Proposed Label Location on EUT

Label Location





EXHIBIT 2 - EUT PHOTOGRAPHS

GTM96180-1811-2.0-T3

EUT View 1



EUT View 2





EUT View 3



EUT View 4





Reference No.: WTX23X06126280E

EUT View 5



EUT View 6





EUT View 7



GTM91120-3024-T3A
EUT View 8





Reference No.: WTX23X06126280E

EUT View 9



EUT View 10





EUT View 11



EUT View 12





EUT View 13



EUT View 14

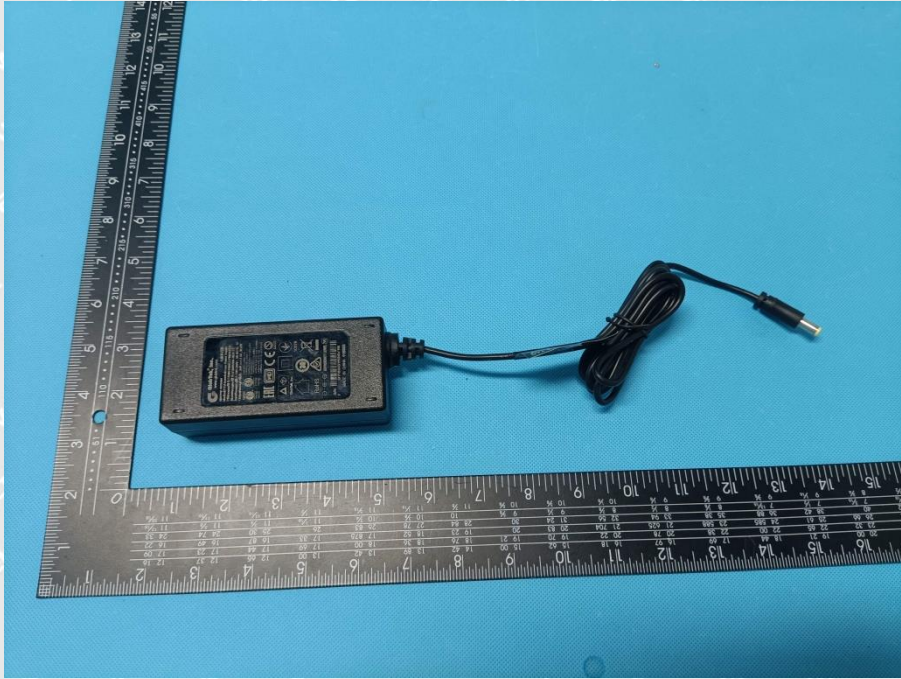




Reference No.: WTX23X06126280E

GTM96300-3624-T2

EUT View 15



EUT View 16





EUT View 17



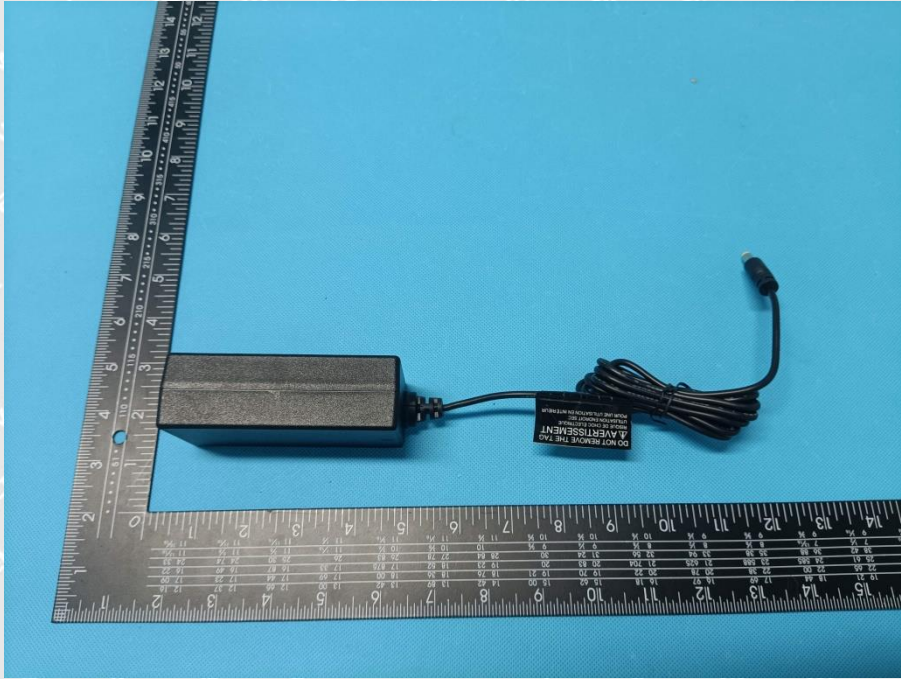
EUT View 18





Reference No.: WTX23X06126280E

EUT View 19



EUT View 20





EUT View 21



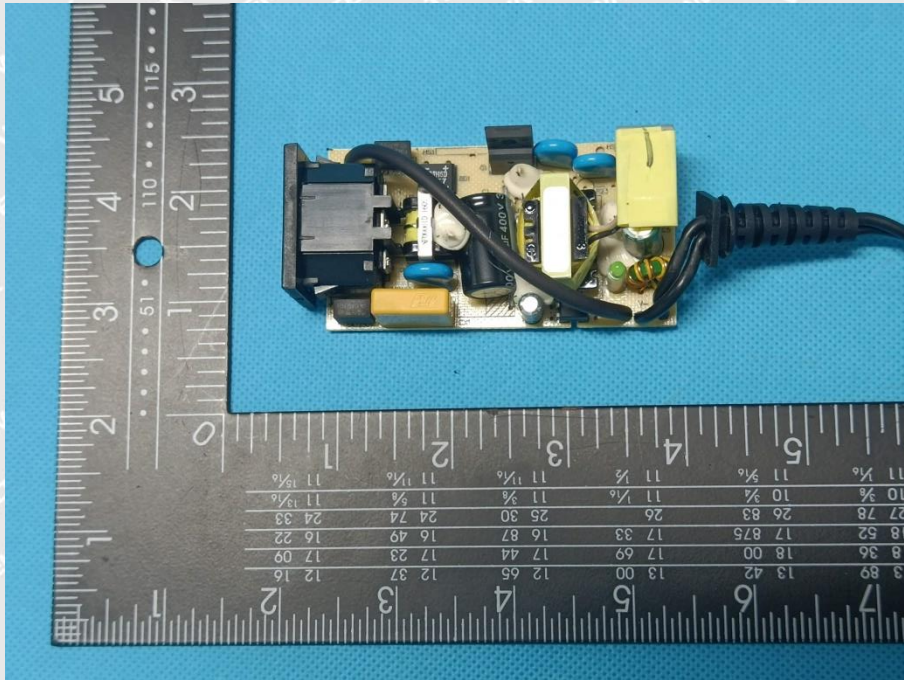
WALTEK



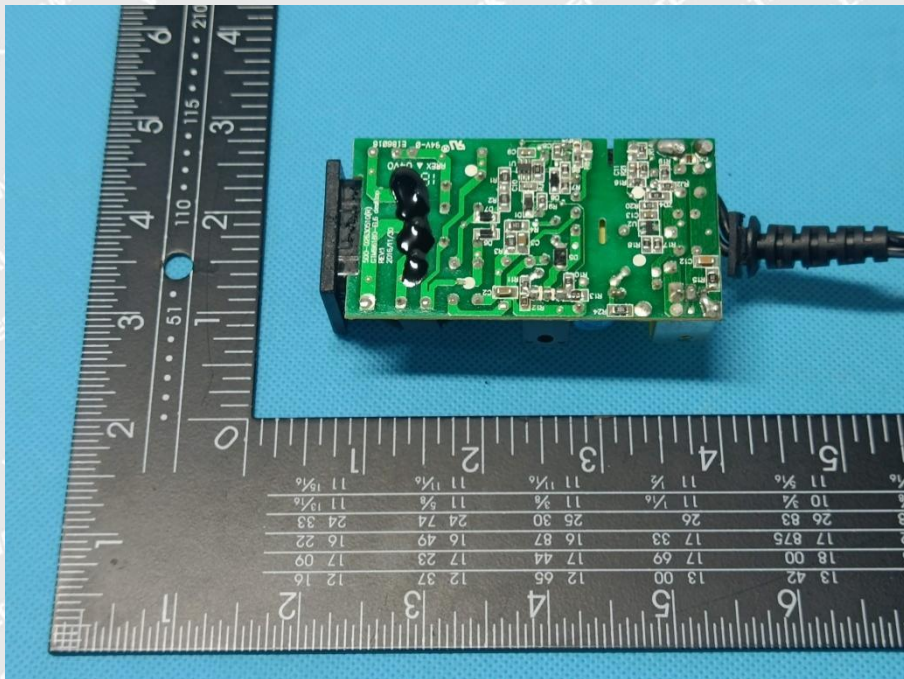
Reference No.: WTX23X06126280E

GTM96180-1811-2.0-T3

Solder Board-Component View 1



Solder Board-Component View 2

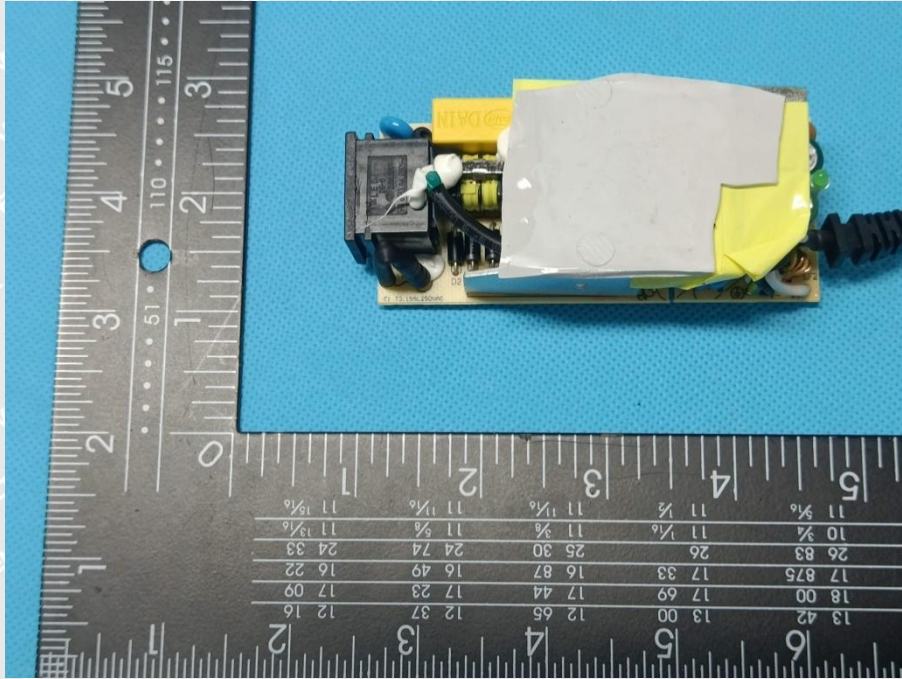




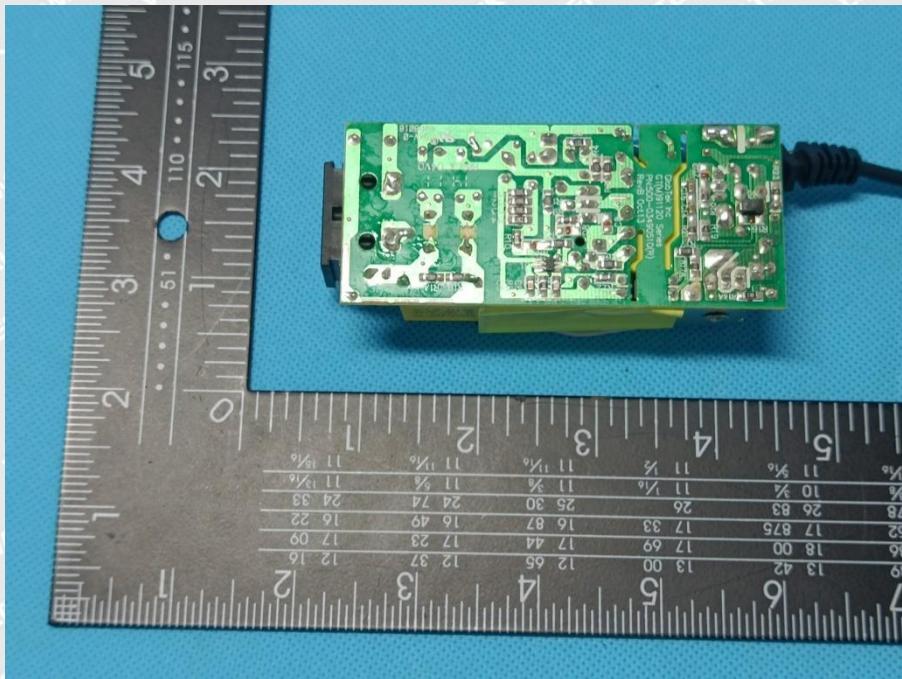
Reference No.: WTX23X06126280E

GTM91120-3024-T3A

Solder Board-Component View 3



Solder Board-Component View 4

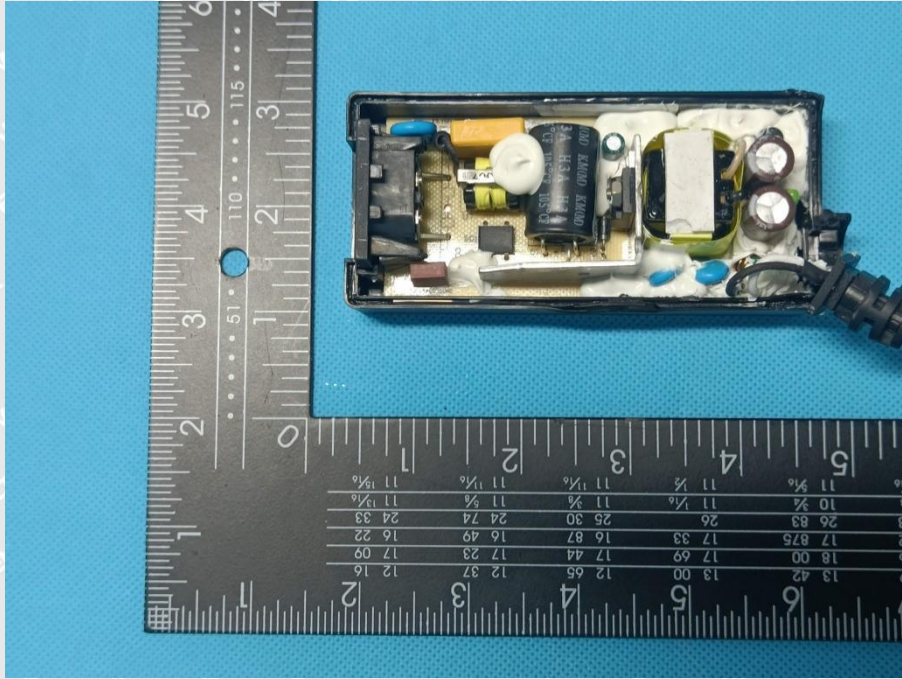


Reference No.: WTX23X06126280E



GTM96300-3624-T2

Solder Board-Component View 5

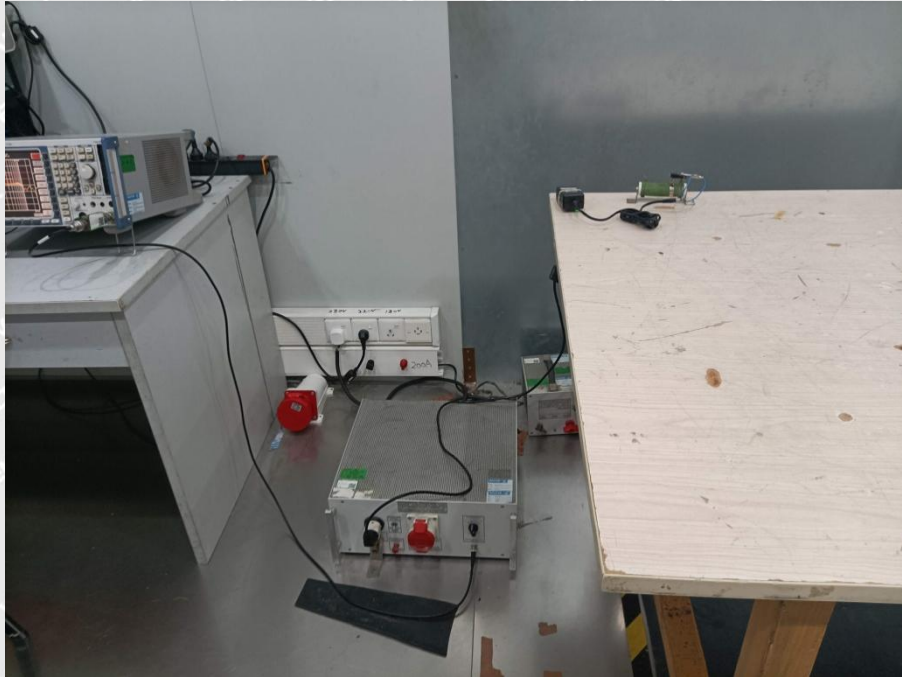


WALTEK

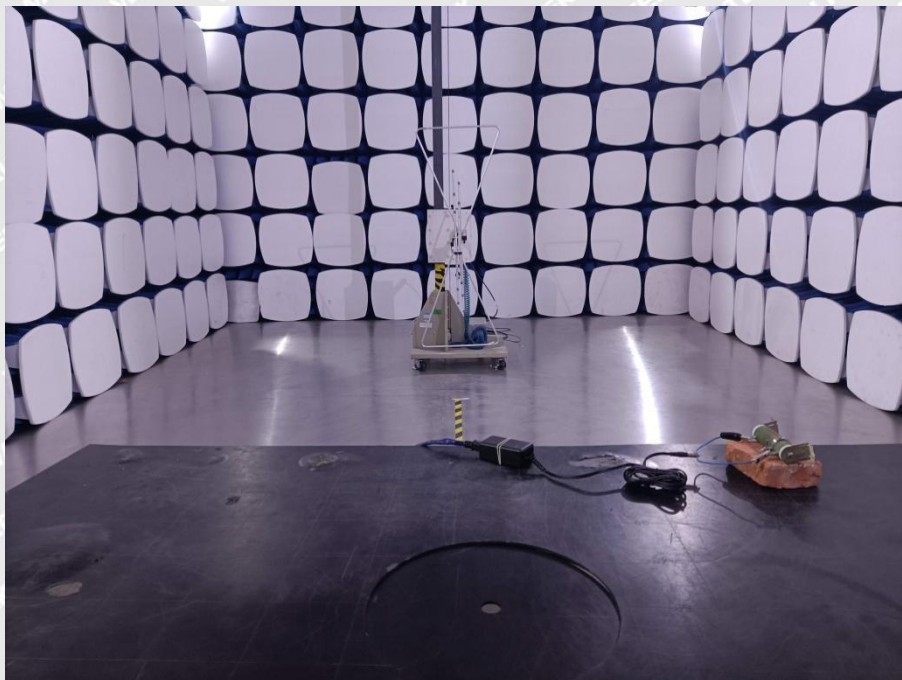


EXHIBIT 3 - TEST SETUP PHOTOGRAPHS

Conduction Emission Test View



Radiation Emission Test View





Harmonic/Flicker Test View



IEC 61000-4-2 Test View





Reference No.: WTX23X06126280E

IEC 61000-4-3 Test View



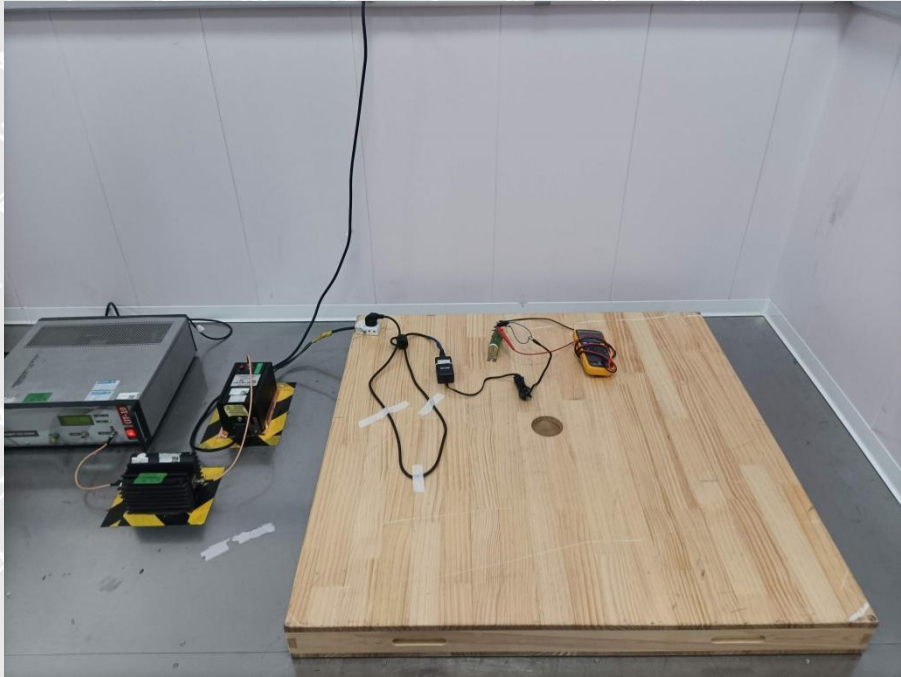
IEC 61000-4-4/5/11 Test View





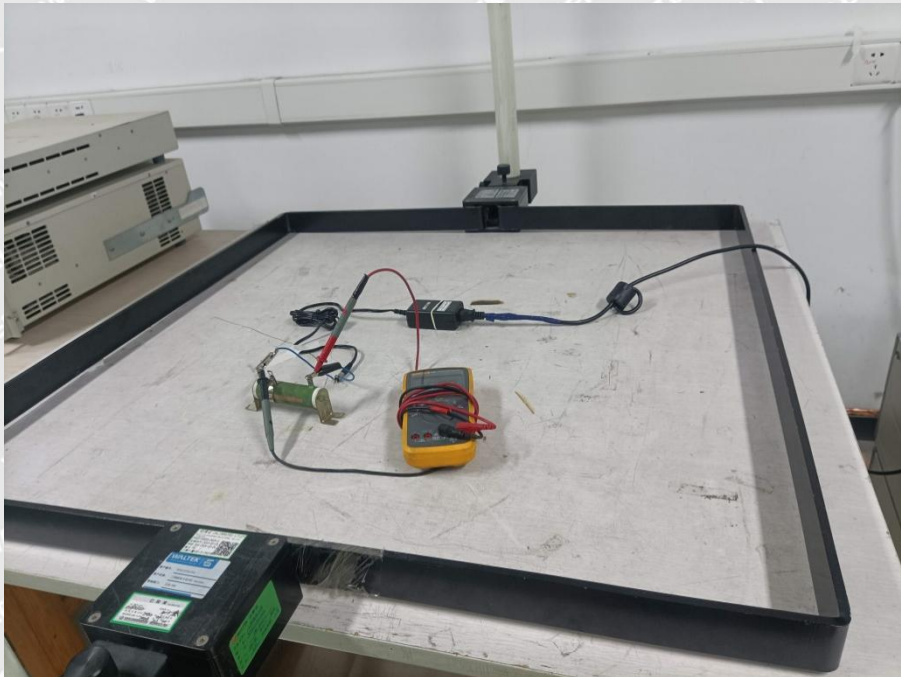
Reference No.: WTX23X06126280E

IEC 61000-4-6 Test View



WALTEK

IEC 61000-4-8 Test View



******* END OF REPORT *******