



Test Report issued under the responsibility of:



**TEST REPORT
IEC 62368-1
Audio/video, information and communication technology equipment
Part 1: Safety requirements**

Report Number..... : 230501695SHA-001
Date of issue : 2023-08-10
Total number of pages : 207 pages

Name of Testing Laboratory preparing the Report : Intertek Testing Services Shanghai

Applicant's name : GlobTek, Inc.
Address : 186 Veterans Drive Northvale NJ 07647, USA

Test specification:
Standard : IEC 62368-1:2018
Test procedure..... : CB Scheme
Non-standard test method..... : N/A

TRF template used : IECEE OD-2020-F1:2021, Ed.1.4
Test Report Form No...... : IEC62368_1E
Test Report Form(s) Originator.... : UL(US)
Master TRF : Dated 2022-04-14

Copyright © 2022 IEC System of Conformity Assessment Schemes for Electrotechnical Equipment and Components (IECEE System). All rights reserved.



This publication may be reproduced in whole or in part for non-commercial purposes as long as the IECEE is acknowledged as copyright owner and source of the material. IECEE takes no responsibility for and will not assume liability for damages resulting from the reader's interpretation of the reproduced material due to its placement and context.

If this Test Report Form is used by non-IECEE members, the IECEE/IEC logo and the reference to the CB Scheme procedure shall be removed.

This report is not valid as a CB Test Report unless signed by an approved CB Testing Laboratory and appended to a CB Test Certificate issued by an NCB in accordance with IECEE 02.

General disclaimer:

The test results presented in this report relate only to the object tested.
This report shall not be reproduced, except in full, without the written approval of the Issuing CB Testing Laboratory. The authenticity of this Test Report and its contents can be verified by contacting the NCB, responsible for this Test Report.

Test item description	ICT/ITE Power Supply	
Trade Mark(s)		
Manufacturer	Same as applicant	
Model/Type reference	GT*96180-*****, GT*96300-*****, GT*91120-*****, GTM91128LI*CEL**_****, GTM91128***_**** (Refer to page 8 for details)	
Ratings	Input: 100-240V~, 50-60Hz or 50/60Hz, 0.6A / 1.0A / 1.5A; Output: 5-56VDC, Max. 4.5A, Max. 36W	
Responsible Testing Laboratory (as applicable), testing procedure and testing location(s):		
<input checked="" type="checkbox"/> CB Testing Laboratory:	Intertek Testing Services Shanghai	
Testing location/ address	Building No. 86, 1198 Qinzhou Road (North) 200233 Shanghai CHINA	
Tested by (name, function, signature)	Ade Yang (Engineer)	
Approved by (name, function, signature) ..	Jacky Shu (Mandated Reviewer)	
<input type="checkbox"/> Testing procedure: CTF Stage 1:		
Testing location/ address		
Tested by (name, function, signature)		
Approved by (name, function, signature) ..		
<input type="checkbox"/> Testing procedure: CTF Stage 2:		
Testing location/ address		
Tested by (name, function, signature)		
Witnessed by (name, function, signature) . :		
Approved by (name, function, signature) .. :		
<input type="checkbox"/> Testing procedure: CTF Stage 3:		
<input type="checkbox"/> Testing procedure: CTF Stage 4:		
Testing location/ address		
Tested by (name, function, signature)		
Witnessed by (name, function, signature) . :		
Approved by (name, function, signature) .. :		
Supervised by (name, function, signature) :		

List of Attachments (including a total number of pages in each attachment):	
Page 85 – 105:	Group and national differences for the CENELEC countries
Page 106 – 112:	National differences for USA and Canada
Page 113 – 119:	National differences for Australia and New Zealand
Page 120 – 122:	National differences for Singapore
Page 123 – 127:	National differences for China
Page 128 – 133:	National differences for Japan
Page 134:	National differences for Saudi Arabia
Page 135 – 136:	Equipment combined with two-pole plug (Class II)
Page 137 – 138:	Dimensions of integral plug
Page 139:	Photo of Plug
Page 140:	Mechanical durability test for non-standard interchangeable plug adapters according to IEC 61984: 2008
Page 141 – 207:	Photos
Summary of testing:	
All tests are performed and the most disadvantageous results are recorded. We conclude that the appliances comply with this standard.	
Tests performed (name of test and test clause):	Testing location:
<p>5.2, Classification of electrical energy sources</p> <p>5.3.2, Accessibility to electrical energy sources and safeguards (Accessibility test)</p> <p>5.4.1.4, 6.3, 6.4, 9.0, B.2.6, B.3, B.4, Annex G.5.3, G.5.4, Heating test and abnormal & fault condition test</p> <p>5.4.1.8, Determination of working voltage</p> <p>5.4.2, 5.4.3, Annex X, Measurement of Clearance and Creepage Distances</p> <p>5.4.8, Humidity test</p> <p>5.4.9, Electric strength test</p> <p>5.5.2.2, Safeguards against capacitance discharge test</p> <p>5.6.6.2, Resistance of the protective bonding system (Ground continuity test)</p> <p>5.7.2.1, Measurement of touch current</p> <p>5.7.4, 5.7.5, Earthed accessible conductive part test</p> <p>6.2.2, Electrical Power Source (PS) measurements for classification</p> <p>6.2.3.1, Determination of Potential Ignition Sources (Arcing PIS)</p> <p>6.2.3.2, Determination of Potential Ignition Sources (Resistive PIS)</p> <p>B.2.5, Input test</p> <p>B.3, B.4, Simulated abnormal operating and single fault Conditions</p> <p>Annex F.3.10, Durability, legibility and permanence of markings</p> <p>Annex Q.1, Limited power sources</p> <p>T.2, T.5, Steady force test, 10N, 250N</p> <p>T.6, Enclosure impact test</p> <p>T.7, Drop test</p> <p>T.8, Stress relief test</p>	<p>Intertek Testing Services Shanghai</p> <p>Building No.86, 1198 Qinzhou Road (North), 200233 Shanghai, China</p>

The equipment under test (EUT) fulfilled the test requirement according to the standard IEC 62368-1:2018 and EN IEC 62368-1:2020 + A11:2020.	
<p>Summary of compliance with National Differences (List of countries addressed):</p> <p>The group and national differences for the CENELEC countries have been checked. The national differences for USA, Canada, Australia, New Zealand, Singapore, China, Japan and Saudi Arabia have been checked according to IEC 62368-1:2018.</p> <p><input checked="" type="checkbox"/> The product fulfils the requirements of IEC 62368-1:2018 and EN IEC 62368-1:2020 + A11:2020.</p>	
<p>Statement concerning the uncertainty of the measurement systems used for the tests (may be required by the product standard or client)</p> <p><input type="checkbox"/> Internal procedure used for type testing through which traceability of the measuring uncertainty has been established:</p> <p>Procedure number, issue date and title:</p> <p>Calculations leading to the reported values are on file with the NCB and testing laboratory that conducted the testing.</p> <p><input checked="" type="checkbox"/> Statement not required by the standard used for type testing</p> <p>(Note: When IEC or ISO standard requires a statement concerning the uncertainty of the measurement systems used for tests, this should be reported above. The informative text in parenthesis should be delete in both cases after selecting the applicable option)</p>	

Copy of marking plate:

The artwork below may be only a draft. The use of certification marks on a product must be authorized by the respective NCBs that own these marks.

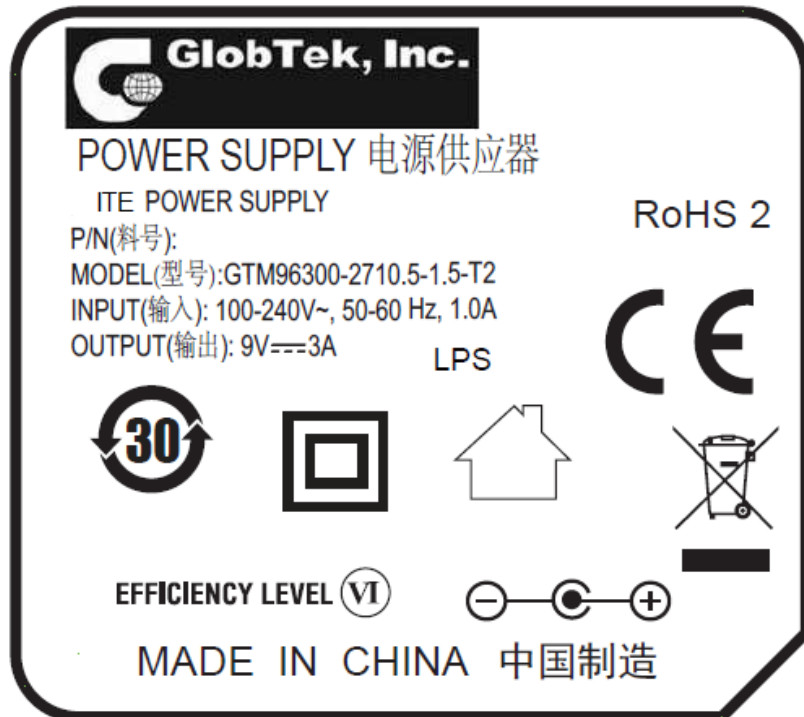

Note: For other models, marking plates are the same except for model name and output ratings.

Test item particulars:	
Product group	<input checked="" type="checkbox"/> end product <input type="checkbox"/> built-in component
Classification of use by	<input checked="" type="checkbox"/> Ordinary person <input checked="" type="checkbox"/> Children likely present <input type="checkbox"/> Instructed person <input type="checkbox"/> Skilled person
Supply connection	<input checked="" type="checkbox"/> AC mains <input type="checkbox"/> DC mains <input type="checkbox"/> not mains connected: <input type="checkbox"/> ES1 <input type="checkbox"/> ES2 <input type="checkbox"/> ES3
Supply tolerance	<input checked="" type="checkbox"/> +10%/-10% <input type="checkbox"/> +20%/-15% <input type="checkbox"/> + %/ - % <input type="checkbox"/> None
Supply connection – type	<input checked="" type="checkbox"/> pluggable equipment type A - <input type="checkbox"/> non-detachable supply cord <input checked="" type="checkbox"/> appliance coupler <input checked="" type="checkbox"/> direct plug-in <input type="checkbox"/> pluggable equipment type B - <input type="checkbox"/> non-detachable supply cord <input type="checkbox"/> appliance coupler <input type="checkbox"/> permanent connection <input type="checkbox"/> mating connector <input type="checkbox"/> other:
Considered current rating of protective device	<input checked="" type="checkbox"/> 16A or 20A; Location: <input checked="" type="checkbox"/> building <input type="checkbox"/> equipment <input type="checkbox"/> N/A
Equipment mobility	<input type="checkbox"/> movable <input type="checkbox"/> hand-held <input checked="" type="checkbox"/> transportable <input checked="" type="checkbox"/> direct plug-in <input type="checkbox"/> stationary <input checked="" type="checkbox"/> for building-in <input type="checkbox"/> wall/ceiling-mounted <input type="checkbox"/> SRME/rack-mounted <input type="checkbox"/> other:
Overvoltage category (OVC)	<input type="checkbox"/> OVC I <input checked="" type="checkbox"/> OVC II <input type="checkbox"/> OVC III <input type="checkbox"/> OVC IV <input type="checkbox"/> other:
Class of equipment	<input checked="" type="checkbox"/> Class I (See 'Model Differences' for details) <input checked="" type="checkbox"/> Class II (See 'Model Differences' for details) <input type="checkbox"/> Class III <input type="checkbox"/> Not classified <input type="checkbox"/>
Special installation location	<input checked="" type="checkbox"/> N/A <input type="checkbox"/> restricted access area <input type="checkbox"/> outdoor location <input type="checkbox"/>
Pollution degree (PD)	<input type="checkbox"/> PD 1 <input checked="" type="checkbox"/> PD 2 <input type="checkbox"/> PD 3
Manufacturer's specified T_{ma}	40 °C <input type="checkbox"/> Outdoor:
IP protection class	<input checked="" type="checkbox"/> IPX0 <input type="checkbox"/> IP__
Power systems	<input checked="" type="checkbox"/> TN <input type="checkbox"/> TT <input checked="" type="checkbox"/> IT – 230 V _{L-L} <input type="checkbox"/> not AC mains
Altitude during operation (m)	<input type="checkbox"/> 2000m or less <input checked="" type="checkbox"/> 5000m
Altitude of test laboratory (m)	<input checked="" type="checkbox"/> 2000m or less <input type="checkbox"/> m
Mass of equipment (kg)	Less than 1kg

Possible test case verdicts:	
- test case does not apply to the test object.....: N/A	
- test object does meet the requirement: P (Pass)	
- test object does not meet the requirement ...: F (Fail)	
Testing:	
Date of receipt of test item: 2021-04-07	
Date (s) of performance of tests.....: 2021-04-07 to 2021-05-11	
General remarks:	
<p>"(See Enclosure #)" refers to additional information appended to the report. "(See appended table)" refers to a table appended to the report. Throughout this report a <input type="checkbox"/> comma / <input checked="" type="checkbox"/> point is used as the decimal separator. Determination of the test conclusion is based on IEC Guide 115 in consideration of measurement uncertainty. This report is for the exclusive use of Intertek's Client and is provided pursuant to the agreement between Intertek and its Client. Intertek's responsibility and liability are limited to the terms and conditions of the agreement. Intertek assumes no liability to any party, other than to the Client in accordance with the agreement, for any loss, expense or damage occasioned by the use of this report. Only the Client is authorized to permit copying or distribution of this report and then only in its entirety. Any use of the Intertek name or one of its marks for the sale or advertisement of the tested material, product or service must first be approved in writing by Intertek. The observations and test results in this report are relevant only to the sample tested. This report by itself does not imply that the material, product, or service is or has ever been under an Intertek certification program. The samples submitted from for evaluation are representative of the products from each factory.</p>	
Manufacturer's Declaration per sub-clause 4.2.5 of IEC 60060-2:	
The application for obtaining a CB Test Certificate includes more than one factory location and a declaration from the Manufacturer stating that the sample(s) submitted for evaluation is (are) representative of the products from each factory has been provided	<input checked="" type="checkbox"/> Yes <input type="checkbox"/> Not applicable
When differences exist; they shall be identified in the General product information section.	
Name and address of factory (ies).....:	1, GlobTek, Inc. 186 Veterans Drive Northvale NJ 07647, USA 2, GlobTek (Suzhou) Co., Ltd Building 4, No. 76 JinLing East Road, Suzhou Industrial Park, Suzhou, JiangSu, 215021, China

General product information and other remarks:

Product covered by this report is ICT/ITE power supply module.

Desktop / direct plug-in power supplies are provided with suitable external enclosure. The top and bottom parts of the enclosure are ultrasonic welded.

The products were tested to be suitable for connection to ≤ 16 A (IEC) and ≤ 20 A (USA) branch circuit in series. The unit is approved for TN mains star connections. The unit provides internally two fuses.

The power supplies are rated class I or class II. Open frame and encapsulated class I power supplies shall be properly bonded to the main protective bonding termination in the end product.

All the types are designed for continuous operation.

The model series GT*96180-***** wall plug in with interchangeable blade and desktop type have same circuit diagram, The model series GT*96300-***** have same enclosure with smooth surface or groove surface and PCB Layout size, The model series GT*91120-***** and GTM91128 series have same enclosure with groove surface and PCB Layout size; The transformer with EE16 core used in GT*96180-***** have the same primary windings but different with secondary windings and constructions. The transformer with EE22 core used in GT*96300-*****, GT*91120-***** and GTM91128 series have the same primary windings but different with secondary windings and constructions.

Model Differences

GT*96180-*****,

The 1st "*" part can be 'M' or '-' or 'H' for market identification and not related to safety.

The 2nd "*" denotes the rated output wattage designation, which can be "01" to "18", with interval of 1.

The 3rd "*" denotes the standard rated output voltage designation, which can be "07", "11", "17.9", "30", "38", "48", "54" or "56";

The 4th "*" is optional deviation, subtracted from standard output voltage, which can be "-0.01" to "-12.0" with interval of 0.01, or blank to indicate no voltage different.

The 3rd "*" and 4th "*" together denote the output voltage, with a range of 5 - 56 volts.

The 5th "*" = blank, it means wall plug in with interchangeable blade

=-T2 means desktop class II with C8 AC inlet

=-T2A means desktop class II with C18 AC inlet

=-T3 means desktop class I or class II with functional earth with C14 AC inlet

=-T3A means desktop class I or class II with functional earth with C6 AC inlet

The 6th "*" = Blank or -AP or -PP or -SP

-AP (with baby board) stands for Active POE (full IEEE compliant)

-PP (no baby board) stands for Passive POE

-SP (no baby board) stands for Simple POE

The last * denote any six character = 0-9 or A-Z or () or - or blank for marketing purposes.

The model GTM96180-1830-12.0 which has an output de-rating load 18VDC, 0.3A complies with de-rating test under 75°C ambient.

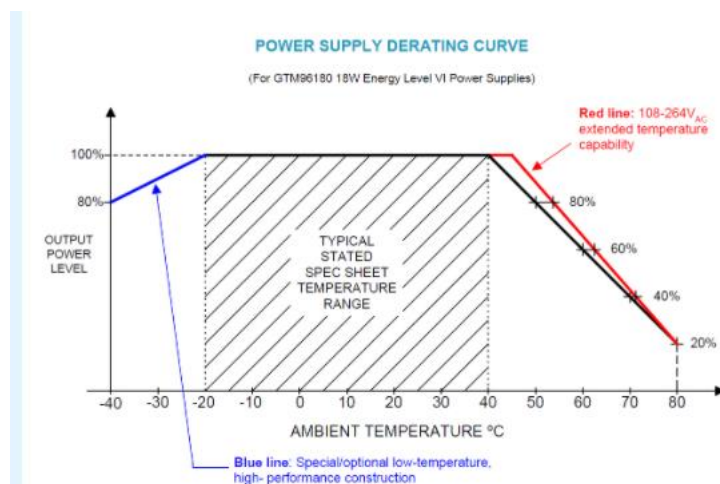

Ratings

When the 6th "*" is blank:

GT*96180-*****, Input: 100-240V~, 50-60Hz or 50/60Hz, 0.6A, Output: 5-48Vdc, Max. 3.6A, Max. 18W

When the 6th "*" = -AP or -PP or -SP:

GT*96180-*****, Input: 100-240V~, 50-60Hz or 50/60Hz, 0.6A, Output: 18-56Vdc, Max. 1.0A, Max. 18W

Model list:

GT*96180-**** Interchangeable plug models

Model	Output Voltage	Max. output current	Max. output power
GT*96180-*07**	5-7V	3.6A	18W
GT*96180-*11**	7.1-11V	2.53A	18W
GT*96180-*17.9**	11.1-17.9V	1.62A	18W
GT*96180-*30**	18-30V	1.0A	18W
GT*96180-*38**	30.1-38V	0.6A	18W
GT*96180-*48**	38.1-48V	0.47A	18W

GT*96180-***-T2/T2A/T3/T3A* Desktop models

Model	Output Voltage	Max. output current	Max. output power
GT*96180-*07*-T2/T2A/T3/T3A*	5-7V	3.6A	18W
GT*96180-*11*-T2/T2A/T3/T3A*	7.1-11V	2.53A	18W
GT*96180-*17.9*-T2/T2A/T3/T3A*	11.1-17.9V	1.62A	18W
GT*96180-*30*-T2/T2A/T3/T3A*	18-30V	1.0A	18W
GT*96180-*38*-T2/T2A/T3/T3A*	30.1-38V	0.6A	18W
GT*96180-*48*-T2/T2A/T3/T3A*	38.1-48V	0.47A	18W

GT*96180-***-T2/T2A/T3/T3A/R2/R3A-AP/PP/SP*

Model	Output Voltage	Max. output current	Max. output power
GT*96180-*30-12.0-T2/T2A/T3/T3A/R2/R3A-AP/PP/SP*	18V	1A	18W
GT*96180-*30-6.0-T2/T2A/T3/T3A/R2/R3A-AP/PP/SP*	24V	0.75A	18W
GT*96180-*38-2.0-T2/T2A/T3/T3A/R2/R3A-AP/PP/SP*	36V	0.5A	18W
GT*96180-*48-T2/T2A/T3/T3A/R2/R3A-AP/PP/SP*	48V	0.375A	18W
GT*96180-*54-T2/T2A/T3/T3A/R2/R3A-AP/PP/SP*	54V	0.33A	18W
GT*96180-*56-T2/T2A/T3/T3A/R2/R3A-AP/PP/SP*	56V	0.32A	18W

GT*96300-***** and GT*91120-*****

The 1st "*" part can be 'M' or '-' or 'H' for market identification and not related to safety.

The 2nd "*" denotes the rated output wattage designation, which can be "01" to "36", with interval of 1.

The 3rd "*" denotes the standard rated output voltage designation, which can be "07.5", "10.5", "14.5", "19.5", "24", "36", "48", "54" or "56";

The 4th "*" is optional deviation, subtracted from standard output voltage, which can be "-0.01" to "-11.9" with interval of 0.01, or blank to indicate no voltage different.

The 3rd "*" and 4th "*" together denote the output voltage, with a range of 5 - 56 volts.

The 5th "*" =-T2 means desktop class II with C8 AC inlet

=-T2A means desktop class II with C18 AC inlet

=-T3 means desktop class I or class II with functional earth with C14 AC inlet

=-T3A means desktop class I or class II with functional earth with C6 AC inlet

=-R2 means hybrid desktop housing class II with C8 AC inlet

=-R3A means hybrid desktop housing class I or class II with functional earth with C6 AC inlet

=-F means Open Frame class I or class II with functional earth

=-FW means Open Frame class II

=-P2 means Encapsulated class II

=-P3 means Encapsulated class I or class II with functional earth

The 6th "*" = Blank or -AP or -PP or -SP

-AP (with baby board) stands for Active POE (full IEEE compliant)

-PP (no baby board) stands for Passive POE

-SP (no baby board) stands for Simple POE

The last * denote any six character = 0-9 or A-Z or () [] or – or blank for marketing purposes.

Ratings

When the 6th "*" is blank:

GT*96300-*****, Input: 100-240V~, 50-60Hz or 50/60Hz, 1.0A, Output: 5-48Vdc, Max. 4.5A, Max. 36W

GT*91120-*****, Input: 100-240V~, 50-60Hz or 50/60Hz, 1.5A, Output: 5-48Vdc, Max. 4A, Max. 30W

When the 6th "*" = -AP or -PP or -SP:

GT*96300-*****, Input: 100-240V~, 50-60Hz or 50/60Hz, 1.0A, Output: 18-56Vdc, Max. 2.0A, Max. 36W

Model list:

GT*96300-***-T2/T2A/T3/T3A/R2/R3A* Desktop models

Model	Output Voltage	Max. output current	Max. output power
GT*96300-*07.5*-T2/T2A/T3/T3A/R2/R3A*	5-7.5V	4.5A	22.5W
GT*96300-*10.5*-T2/T2A/T3/T3A/R2/R3A*	7.6-9V	3.94A	30W
GT*96300-*10.5*-T2/T2A/T3/T3A/R2/R3A*	9.1-10.5V	3.95A	36W
GT*96300-*14.5*-T2/T2A/T3/T3A/R2/R3A*	10.6-14.5V	3.39A	36W
GT*96300-*19.5*-T2/T2A/T3/T3A/R2/R3A*	14.6-19.5V	2.46A	36W
GT*96300-*24*-T2/T2A/T3/T3A/R2/R3A*	19.6-24V	1.83A	36W
GT*96300-*36*-T2/T2A/T3/T3A/R2/R3A*	24.1-36V	1.49A	36W
GT*96300-*48*-T2/T2A/T3/T3A/R2/R3A*	36.1-48V	0.99A	36W

GT*91120-***-T2/T3A/F/FW/P2/P3* External/Hybrid desktop or Open Frame or Encapsulated

Model	Output Voltage	Max. output current	Max. output power
GT*91120-*07.5*-T2/T3A/F/FW/P2/P3*	5-7.5V	4A	30W
GT*91120-*10.5*-T2/T3A/F/FW/P2/P3*	7.6-10.5V	3.94A	30W
GT*91120-*14.5*-T2/T3A/F/FW/P2/P3*	10.6-14.5V	2.83A	30W
GT*91120-*19.5*-T2/T3A/F/FW/P2/P3*	14.6-19.5V	2A	30W
GT*91120-*24*-T2/T3A/F/FW/P2/P3*	19.6-24V	1.6A	30W
GT*91120-*36*-T2/T3A/F/FW/P2/P3*	24.1-36V	1.25A	30W
GT*91120-*48*-T2/T3A/F/FW/P2/P3*	36.1-48V	0.83A	30W

GT*96300-***-T2/T2A/T3/T3A/R2/R3A-AP/PP/SP*

Model	Output Voltage	Max. output current	Max. output power
GT*96300-*19.5-1.5-T2/T2A/T3/T3A/R2/R3A-AP/PP/SP*	18V	2A	36W
GT*96300-*24-T2/T2A/T3/T3A/R2/R3A-AP/PP/SP*	24V	1.5A	36W
GT*96300-*36-T2/T2A/T3/T3A/R2/R3A-AP/PP/SP*	36V	1A	36W
GT*96300-*48-T2/T2A/T3/T3A/R2/R3A-AP/PP/SP*	48V	0.75A	36W
GT*96300-*54-T2/T2A/T3/T3A/R2/R3A-AP/PP/SP*	54V	0.66A	36W
GT*96300-*56-T2/T2A/T3/T3A/R2/R3A-AP/PP/SP*	56V	0.64A	36W

GTM91128LI*CEL**-**** series:

The 1st “*” part denotes the number of charging cells, which can be “1” or “2” or “3”.

The 2nd “*” denotes product type, which can be M or blank. M means dual output and blank means Charger only.

The 3rd “*” = blank or -R2 means hybrid desktop housing class II with C8 AC inlet

= -T2 means desktop class II with C8 AC inlet

= -T2A means desktop class II with C18 AC inlet

The 4th “*” part is a 3-digit number code, which can be “042”, “084” or “126”. It represents the Charger output voltage of 4.2V, 8.4V or 12.6V.

The 5th “*” part is a 2-digit number code, which can be from “01” to “20”. It represents the Charger output current from 0.1A to 2.0A with interval of 0.1A.

The 6th “*” part is a 3-digit number code, which can be from “050” to “140”. It represents the Power Supply output voltage from 5.0Vdc to 14.0Vdc with interval of 0.1V.

The 7th “*” part is a 2-digit number code, which can be from “01” to “36”. It represents the Power Supply output current from 0.1A to 3.6A with interval of 0.1A.

When 2nd “*” is blank, the 6th and the 7th “*” is blank too.

There are two alternative PCB layout for this product, with 1 LED or with 2 LEDs. Only the number of LED indicator are different and other part of PCB are identical.

Ratings:

Input: 100-240V~, 50-60Hz or 50/60Hz, 0.6A / 1.0A / 1.5A

Output:

Model	Charger Output Voltage (Vdc)	Max. Charger Output Current (A)	Max. Charger Output Power (W)	Power Supply Output Voltage (Vdc)	Max. Power Supply Output Current (A)	Max. Power Supply Output Power (W)	Max. Combined Output Power (W)
GTM91128LI*C EL*_*_*	4.2	2	8.4	N/A	N/A	N/A	N/A
	8.4	1.6	13.44	N/A	N/A	N/A	N/A
	12.6	1.4	17.64	N/A	N/A	N/A	N/A
GTM91128LI*C ELM*_*_*_*	4.2	1.8	7.56	5-7.5	3.6	18	20
	8.4	1.4	11.76	9.5-12	2.3	21.85	25
	12.6	1.2	15.12	14	1.9	26.6	30

Model GTM91128LI1CEL Output: 4.2V, 1.0A;

Model GTM91128LI2CEL Output: 8.4V, 1.0A;

Model GTM91128LI3CEL Output: 12.6V, 1.0A;

GTM91128***_*_*_* series:

The 1st “*” denotes any two characters for marketing purposes.

The 2nd “*” denotes product type, which can be CHRGE or DUALC. CHRGE means charger only. DUALC means dual output.

The 3rd “*” = blank or -R2 means hybrid desktop housing class II with C8 AC inlet

= -T2 means desktop class II with C8 AC inlet

= -T2A means desktop class II with C18 AC inlet

The 4th “*” part is a 3-digit number code from “032” to “126”. It represents the Charger output voltage from 3.2V to 12.6V with interval of 0.1V.

The 5th “*” part is a 2-digit number code from “01” to “20”. It represents the Charger output current from 0.1A to 2.0A with interval of 0.1A.

The 6th “*” part is a 3-digit number code, which can be from “050” to “140”. It represents the Power Supply output voltage from 5.0Vdc to 14.0Vdc with interval of 0.1V.

The 7th “*” part is a 2-digit number code, which can be from “01” to “36”. It represents the Power Supply output current from 0.1A to 3.6A with interval of 0.1A.

When 2nd “*” is CHRGE, the 6th and the 7th “*” is blank too.

There are two alternative PCB layout for this product, with 1 LED or with 2 LEDs. Only the number of LED indicator are different and other part of PCB are identical.

Ratings:

Input: 100-240V~, 50-60Hz or 50/60Hz, 0.6A / 1.0A / 1.5A

Output:

Model	Charger Output Voltage (Vdc)	Max. Charger Output Current (A)	Max. Charger Output Power (W)	Power Supply Output Voltage (Vdc)	Max. Power Supply Output Current (A)	Max. Power Supply Output Power (W)	Max. Combined Output Power (W)
GTM91128* CHARGE*_*	3.2-5.9	2	8.4	N/A	N/A	N/A	N/A
	6.0-8.9	1.6	13.44	N/A	N/A	N/A	N/A
	9.0-12.6	1.4	17.64	N/A	N/A	N/A	N/A
GTM91128* DUALC*_*	3.2-5.9	1.8	7.56	5-7.5	3.6	18	20
	6.0-8.9	1.4	12.46	9.5-12	2.3	21.85	25
	9.0-12.6	1.2	15.12	14	1.9	26.6	30

GTM91128LI*CEL**_* series and GTM91128***_* series are same except their model number and charger output voltage.

Additional application considerations – (Considerations used to test a component or sub-assembly)

N/A

OVERVIEW OF ENERGY SOURCES AND SAFEGUARDS				
Clause	Possible Hazard			
5	Electrically-caused injury			
Class and Energy Source (e.g. ES3: Primary circuit)	Body Part (e.g. Ordinary)	Safeguards		
		B	S	R
ES3: Primary circuit before transformer	Ordinary	N/A	N/A	Plastic enclosure
ES1: Secondary circuit after transformer	Ordinary	N/A	N/A	N/A
6	Electrically-caused fire			
Class and Energy Source (e.g. PS2: 100 Watt circuit)	Material part (e.g. Printed board)	Safeguards		
		B	1 st S	2 nd S
PS3: All circuits (except data ports)	All combustible materials on mainboard	Ignition not occur	Fire enclosure	N/A
PS2: data ports	All combustible materials on mainboard	Ignition not occur	N/A	N/A
PS1: data ports	All combustible materials on mainboard	N/A	N/A	N/A
7	Injury caused by hazardous substances			
Class and Energy Source (e.g. Ozone)	Body Part (e.g., Skilled)	Safeguards		
		B	S	R
N/A	N/A	N/A	N/A	N/A
8	Mechanically-caused injury			
Class and Energy Source (e.g. MS3: Plastic fan blades)	Body Part (e.g. Ordinary)	Safeguards		
		B	S	R
MS1: Sharp edges and corners	Ordinary	N/A	N/A	N/A
MS1: Equipment mass	Ordinary	N/A	N/A	N/A
9	Thermal burn			
Class and Energy Source (e.g. TS1: Keyboard caps)	Body Part (e.g., Ordinary)	Safeguards		
		B	S	R
TS1: Accessible parts	Ordinary	N/A	N/A	N/A
10	Radiation			
Class and Energy Source (e.g. RS1: PMP sound output)	Body Part (e.g., Ordinary)	Safeguards		
		B	S	R
RS1: Indicating lights	Ordinary	N/A	N/A	N/A
Supplementary Information: “B” – Basic Safeguard; “S” – Supplementary Safeguard; “R” – Reinforced Safeguard				

ENERGY SOURCE DIAGRAM

Optional. Manufacturers are to provide the energy sources diagram identify declared energy sources and identifying the demarcations are between power sources. Recommend diagram be provided included in power supply and multipart systems.

Insert diagram below. Example diagram designs are; Block diagrams; image(s) with layered data; mechanical drawings

ES **PS** **MS** **TS** **RS**

See "Source of electrical energy" and "Source of power or PIS" on previous page for details.

IEC 62368-1			
Clause	Requirement + Test	Result - Remark	Verdict
4	GENERAL REQUIREMENTS		P
4.1.1	Acceptance of materials, components and subassemblies	See appended table 4.1.2.	P
4.1.2	Use of components	Components which are certified to IEC and/or national standards are used correctly within their ratings. Components not covered by IEC standards are tested under the conditions present in the equipment.	P
4.1.3	Equipment design and construction	No accessible part which could cause injury.	P
4.1.4	Specified ambient temperature for outdoor use (°C) :		N/A
4.1.5	Constructions and components not specifically covered		N/A
4.1.8	Liquids and liquid filled components (LFC)		N/A
4.1.15	Markings and instructions		P
4.4.3	Safeguard robustness		P
4.4.3.1	General		P
4.4.3.2	Steady force tests		P
4.4.3.3	Drop tests	See Annex T.	P
4.4.3.4	Impact tests	See Annex T.	N/A
4.4.3.5	Internal accessible safeguard tests		N/A
4.4.3.6	Glass impact tests		N/A
4.4.3.7	Glass fixation tests		N/A
	Glass impact test (1J)		N/A
	Push/pull test (10 N)		N/A
4.4.3.8	Thermoplastic material tests	See Annex T.	P
4.4.3.9	Air comprising a safeguard		N/A
4.4.3.10	Accessibility, glass, safeguard effectiveness	Compliance checked.	P
4.4.4	Displacement of a safeguard by an insulating liquid		N/A
4.4.5	Safety interlocks		N/A
4.5	Explosion		P
4.5.1	General	No explosion occurs during normal/abnormal operation and single fault conditions.	P

IEC 62368-1			
Clause	Requirement + Test	Result - Remark	Verdict
4.5.2	No explosion during normal/abnormal operating condition		N/A
	No harm by explosion during single fault conditions		N/A
4.6	Fixing of conductors		P
	Fix conductors not to defeat a safeguard		P
	Compliance is checked by test : (See Clause T.2)		P
4.7	Equipment for direct insertion into mains socket-outlets		N/A
4.7.2	Mains plug part complies with relevant standard .. :	Not direct plug-in plug	N/A
4.7.3	Torque (Nm) :		N/A
4.8	Equipment containing coin/button cell batteries		N/A
4.8.1	General		N/A
4.8.2	Instructional safeguard :		N/A
4.8.3	Battery compartment door/cover construction		N/A
	Open torque test		N/A
4.8.4.2	Stress relief test		N/A
4.8.4.3	Battery replacement test		N/A
4.8.4.4	Drop test		N/A
4.8.4.5	Impact test		N/A
4.8.4.6	Crush test		N/A
4.8.5	Compliance		N/A
	30N force test with test probe		N/A
	20N force test with test hook		N/A
4.9	Likelihood of fire or shock due to entry of conductive object		P
4.10	Component requirements		P
4.10.1	Disconnect Device	(See Annex L)	P
4.10.2	Switches and relays	(See Annex G)	N/A

5	ELECTRICALLY-CAUSED INJURY		P
5.2	Classification and limits of electrical energy sources		P
5.2.2	ES1, ES2 and ES3 limits		P
5.2.2.2	Steady-state voltage and current limits : (See appended table 5.2)		P
5.2.2.3	Capacitance limits : (See appended table 5.2)		P
5.2.2.4	Single pulse limits :		N/A

IEC 62368-1			
Clause	Requirement + Test	Result - Remark	Verdict
5.2.2.5	Limits for repetitive pulses		N/A
5.2.2.6	Ringling signals		N/A
5.2.2.7	Audio signals		N/A
5.3	Protection against electrical energy sources		P
5.3.1	General Requirements for accessible parts to ordinary, instructed and skilled persons		P
5.3.1 a)	Accessible ES1/ES2 derived from ES2/ES3 circuits		P
5.3.1 b)	Skilled persons not unintentional contact ES3 bare conductors		P
5.3.2.1	Accessibility to electrical energy sources and safeguards	ES2 or ES3 source cannot accessed by ordinary persons and ES3 source cannot accessed by instructed persons. Double or reinforced safeguard is provided between ES2 or ES3 and ordinary persons	P
	Accessibility to outdoor equipment bare parts		N/A
5.3.2.2	Contact requirements	See below	P
	Test with test probe from Annex V	Test probe V.1, V.2 applied.	—
5.3.2.2 a)	Air gap – electric strength test potential (V)	(See appended table 5.4.9)	P
5.3.2.2 b)	Air gap – distance (mm)	No openings on enclosures as received and after mechanical test	N/A
5.3.2.3	Compliance		N/A
5.3.2.4	Terminals for connecting stripped wire		N/A
5.4	Insulation materials and requirements		P
5.4.1.2	Properties of insulating material	Hygroscopic materials are not used for insulating material.	P
5.4.1.3	Material is non-hygroscopic	(See sub-clause 5.4.8)	P
5.4.1.4	Maximum operating temperature for insulating materials	(See appended table 5.4.1.4)	P
5.4.1.5	Pollution degrees	Pollution degree 2	P
5.4.1.5.2	Test for pollution degree 1 environment and for an insulating compound		N/A
5.4.1.5.3	Thermal cycling test		N/A
5.4.1.6	Insulation in transformers with varying dimensions		N/A

IEC 62368-1			
Clause	Requirement + Test	Result - Remark	Verdict
5.4.1.7	Insulation in circuits generating starting pulses		N/A
5.4.1.8	Determination of working voltage	(See appended table 5.4.1.8)	P
5.4.1.9	Insulating surfaces		P
5.4.1.10	Thermoplastic parts on which conductive metallic parts are directly mounted	Bobbin materials of all transformers are Phenolic that is accepted without further tests.	P
5.4.1.10.2	Vicat test.....		N/A
5.4.1.10.3	Ball pressure test	(See appended table 5.4.1.10.3)	P
5.4.2	Clearances		P
5.4.2.1	General requirements		P
	Clearances in circuits connected to AC Mains, Alternative method	(See Annex X)	P
5.4.2.2	Procedure 1 for determining clearance	(See appended table 5.4.2.2, 5.4.2.4 and 5.4.3)	P
	Temporary overvoltage	2000V	—
5.4.2.3	Procedure 2 for determining clearance	(See appended table 5.4.2.3)	P
5.4.2.3.2.2	a.c. mains transient voltage	2500V peak	—
5.4.2.3.2.3	d.c. mains transient voltage		—
5.4.2.3.2.4	External circuit transient voltage.....		—
5.4.2.3.2.5	Transient voltage determined by measurement		—
5.4.2.4	Determining the adequacy of a clearance using an electric strength test	(See appended table 5.4.2)	P
5.4.2.5	Multiplication factors for clearances and test voltages	Multiplication factor is 1.48 for altitude up to 5000m.	P
5.4.2.6	Clearance measurement	(See appended table 5.4.2)	P
5.4.3	Creepage distances		P
5.4.3.1	General		P
5.4.3.3	Material group	Material group IIIb assumed.	—
5.4.3.4	Creepage distances measurement	(See appended table 5.4.3)	P
5.4.4	Solid insulation		P
5.4.4.1	General requirements		P
5.4.4.2	Minimum distance through insulation	(See appended table 5.4.4.2)	P
5.4.4.3	Insulating compound forming solid insulation		N/A
5.4.4.4	Solid insulation in semiconductor devices		N/A

IEC 62368-1			
Clause	Requirement + Test	Result - Remark	Verdict
5.4.4.5	Insulating compound forming cemented joints		N/A
5.4.4.6	Thin sheet material		P
5.4.4.6.1	General requirements		P
5.4.4.6.2	Separable thin sheet material	Reinforced insulation.	P
	Number of layers (pcs)	2	P
5.4.4.6.3	Non-separable thin sheet material		N/A
	Number of layers (pcs)		N/A
5.4.4.6.4	Standard test procedure for non-separable thin sheet material		N/A
5.4.4.6.5	Mandrel test		N/A
5.4.4.7	Solid insulation in wound components		N/A
5.4.4.9	Solid insulation at frequencies >30 kHz, E_P , K_R , d , V_{PW} (V)	(See appended Table 5.4.4.9)	N/A
	Alternative by electric strength test, tested voltage (V), K_R		N/A
5.4.5	Antenna terminal insulation		N/A
5.4.5.1	General		N/A
5.4.5.2	Voltage surge test		N/A
5.4.5.3	Insulation resistance (M Ω)		N/A
	Electric strength test		N/A
5.4.6	Insulation of internal wire as part of supplementary safeguard		N/A
5.4.7	Tests for semiconductor components and for cemented joints		N/A
5.4.8	Humidity conditioning		P
	Relative humidity (%), temperature ($^{\circ}$ C), duration (h)	Performed at 40 $^{\circ}$ C, 95% R.H. for 120h.	—
5.4.9	Electric strength test		P
5.4.9.1	Test procedure for type test of solid insulation	(See appended table 5.4.9)	P
5.4.9.2	Test procedure for routine test		N/A
5.4.10	Safeguards against transient voltages from external circuits		N/A
5.4.10.1	Parts and circuits separated from external circuits		N/A
5.4.10.2	Test methods		N/A
5.4.10.2.1	General		N/A

IEC 62368-1			
Clause	Requirement + Test	Result - Remark	Verdict
5.4.10.2.2	Impulse test		N/A
5.4.10.2.3	Steady-state test.....		N/A
5.4.10.3	Verification for insulation breakdown for impulse test		N/A
5.4.11	Separation between external circuits and earth		N/A
5.4.11.1	Exceptions to separation between external circuits and earth		N/A
5.4.11.2	Requirements		N/A
	SPDs bridge separation between external circuit and earth		N/A
	Rated operating voltage U_{op} (V).....		—
	Nominal voltage U_{peak} (V).....		—
	Max increase due to variation ΔU_{sp}		—
	Max increase due to ageing ΔU_{sa}		—
5.4.11.3	Test method and compliance		N/A
5.4.12	Insulating liquid		N/A
5.4.12.1	General requirements		N/A
5.4.12.2	Electric strength of an insulating liquid		N/A
5.4.12.3	Compatibility of an insulating liquid		N/A
5.4.12.4	Container for insulating liquid		N/A
5.5	Components as safeguards		P
5.5.1	General		P
5.5.2	Capacitors and RC units		P
5.5.2.1	General requirement		P
5.5.2.2	Safeguards against capacitor discharge after disconnection of a connector	(See appended table 5.5.2.2)	P
5.5.3	Transformers	(See Annex G.5.3)	P
5.5.4	Optocouplers	(See sub-clause 5.4 or Clause G.12)	P
5.5.5	Relays		N/A
5.5.6	Resistors		N/A
5.5.7	SPDs		P
5.5.8	Insulation between the mains and an external circuit consisting of a coaxial cable		N/A
5.5.9	Safeguards for socket-outlets in outdoor equipment		N/A

IEC 62368-1			
Clause	Requirement + Test	Result - Remark	Verdict
	RCD rated residual operating current (mA) :		—
5.6	Protective conductor		P
5.6.2	Requirement for protective conductors		P
5.6.2.1	General requirements	Class I AC inlet used for models GT**_***-T3/T3A/R3A/F/P3*	P
5.6.2.2	Colour of insulation	Green-and-yellow wire used. For class I equipment	P
5.6.3	Requirement for protective earthing conductors		P
	Protective earthing conductor size (mm ²) :	Approved inlet used	—
	Protective earthing conductor serving as a reinforced safeguard		N/A
	Protective earthing conductor serving as a double safeguard		N/A
5.6.4	Requirements for protective bonding conductors		N/A
5.6.4.1	Protective bonding conductors		N/A
	Protective bonding conductor size (mm ²). :		—
5.6.4.2	Protective current rating (A)..... :		N/A
5.6.5	Terminals for protective conductors	AC inlet direct connect to protective bonding wire	P
5.6.5.1	Terminal size for connecting protective earthing conductors (mm)..... :	Approved inlet used	P
	Terminal size for connecting protective bonding conductors (mm) :		N/A
5.6.5.2	Corrosion	Complied.	P
5.6.6	Resistance of the protective bonding system	See below.	N/A
5.6.6.1	Requirements	See below.	N/A
5.6.6.2	Test Method..... :	(See appended table 5.6.6)	N/A
5.6.6.3	Resistance (Ω) or voltage drop..... :	(See appended table 5.6.6)	N/A
5.6.7	Reliable connection of a protective earthing conductor		N/A
5.6.8	Functional earthing		N/A
	Conductor size (mm ²)..... :		N/A
	Class II with functional earthing marking :		N/A
	Appliance inlet cl & cr (mm) :		N/A
5.7	Prospective touch voltage, touch current and protective conductor current		P

IEC 62368-1			
Clause	Requirement + Test	Result - Remark	Verdict
5.7.2	Measuring devices and networks		P
5.7.2.1	Measurement of touch current		P
5.7.2.2	Measurement of voltage		P
5.7.3	Equipment set-up, supply connections and earth connections		P
5.7.4	Unearthed accessible parts	(See appended table 5.7.4)	P
5.7.5	Earthed accessible conductive parts	(See appended table 5.7.5)	P
5.7.6	Requirements when touch current exceeds ES2 limits		N/A
	Protective conductor current (mA)		N/A
	Instructional Safeguard		N/A
5.7.7	Prospective touch voltage and touch current associated with external circuits		N/A
5.7.7.1	Touch current from coaxial cables		N/A
5.7.7.2	Prospective touch voltage and touch current associated with paired conductor cables		N/A
5.7.8	Summation of touch currents from external circuits		N/A
	a) Equipment connected to earthed external circuits, current (mA)		N/A
	b) Equipment connected to unearthed external circuits, current (mA)		N/A
5.8	Backfeed safeguard in battery backed up supplies		N/A
	Mains terminal ES	(See appended table 5.8)	N/A
	Air gap (mm)		N/A

6	ELECTRICALLY- CAUSED FIRE		P
6.2	Classification of PS and PIS		P
6.2.2	Power source circuit classifications	(See appended table 6.2.2)	P
6.2.3	Classification of potential ignition sources		P
6.2.3.1	Arcing PIS	(See appended table 6.2.3.1)	P
6.2.3.2	Resistive PIS	(See appended table 6.2.3.2)	P
6.3	Safeguards against fire under normal operating and abnormal operating conditions		P
6.3.1	No ignition and attainable temperature value less than 90 % defined by ISO 871 or less than 300 °C for unknown materials	(See appended table B.1.5 and B.3)	P

IEC 62368-1			
Clause	Requirement + Test	Result - Remark	Verdict
	Combustible materials outside fire enclosure :		N/A
6.4	Safeguards against fire under single fault conditions		P
6.4.1	Safeguard method		P
6.4.2	Reduction of the likelihood of ignition under single fault conditions in PS1 circuits		N/A
6.4.3	Reduction of the likelihood of ignition under single fault conditions in PS2 and PS3 circuits		N/A
6.4.3.1	Supplementary safeguards		N/A
6.4.3.2	Single Fault Conditions :	(See appended table B.4)	N/A
	Special conditions for temperature limited by fuse		N/A
6.4.4	Control of fire spread in PS1 circuits		P
6.4.5	Control of fire spread in PS2 circuits		P
6.4.5.2	Supplementary safeguards		P
6.4.6	Control of fire spread in PS3 circuits	Providing fire enclosure for PS3 circuit.	P
6.4.7	Separation of combustible materials from a PIS	Providing fire enclosure for PS3 circuit.	P
6.4.7.2	Separation by distance	See above.	P
6.4.7.3	Separation by a fire barrier		N/A
6.4.8	Fire enclosures and fire barriers		P
6.4.8.2	Fire enclosure and fire barrier material properties		P
6.4.8.2.1	Requirements for a fire barrier	Plastic enclosure served as fire enclosure.	P
6.4.8.2.2	Requirements for a fire enclosure	See above	P
6.4.8.3	Constructional requirements for a fire enclosure and a fire barrier		P
6.4.8.3.1	Fire enclosure and fire barrier openings		P
6.4.8.3.2	Fire barrier dimensions		N/A
6.4.8.3.3	Top openings and properties		P
	Openings dimensions (mm)..... :	No opening	P
6.4.8.3.4	Bottom openings and properties		P
	Openings dimensions (mm)..... :	No opening	P
	Flammability tests for the bottom of a fire enclosure	(See Clause S.3)	N/A
	Instructional Safeguard..... :		N/A
6.4.8.3.5	Side openings and properties		P
	Openings dimensions (mm)..... :	No opening	P

IEC 62368-1			
Clause	Requirement + Test	Result - Remark	Verdict
6.4.8.3.6	Integrity of a fire enclosure, condition met: a), b) or c)		N/A
6.4.8.4	Separation of a PIS from a fire enclosure and a fire barrier distance (mm) or flammability rating	plastic enclosure: V-0.	P
6.4.9	Flammability of insulating liquid.....		N/A
6.5	Internal and external wiring		P
6.5.1	General requirements	Less than 0.5 mm ² UL Approved output cord used.	P
6.5.2	Requirements for interconnection to building wiring		N/A
6.5.3	Internal wiring size (mm ²) for socket-outlets.....		N/A
6.6	Safeguards against fire due to the connection to additional equipment		P

7	INJURY CAUSED BY HAZARDOUS SUBSTANCES		N/A
7.2	Reduction of exposure to hazardous substances		N/A
7.3	Ozone exposure		N/A
7.4	Use of personal safeguards or personal protective equipment (PPE)		N/A
	Personal safeguards and instructions		—
7.5	Use of instructional safeguards and instructions		N/A
	Instructional safeguard (ISO 7010).....		—
7.6	Batteries and their protection circuits		N/A

8	MECHANICALLY-CAUSED INJURY		P
8.2	Mechanical energy source classifications		P
8.3	Safeguards against mechanical energy sources		P
8.4	Safeguards against parts with sharp edges and corners		P
8.4.1	Safeguards		P
	Instructional Safeguard.....		N/A
8.4.2	Sharp edges or corners		P
8.5	Safeguards against moving parts		N/A
8.5.1	Fingers, jewellery, clothing, hair, etc., contact with MS2 or MS3 parts		N/A
	MS2 or MS3 part required to be accessible for the function of the equipment		N/A

IEC 62368-1			
Clause	Requirement + Test	Result - Remark	Verdict
	Moving MS3 parts only accessible to skilled person		N/A
8.5.2	Instructional safeguard.....:		N/A
8.5.4	Special categories of equipment containing moving parts		N/A
8.5.4.1	General		N/A
8.5.4.2	Equipment containing work cells with MS3 parts		N/A
8.5.4.2.1	Protection of persons in the work cell		N/A
8.5.4.2.2	Access protection override		N/A
8.5.4.2.2.1	Override system		N/A
8.5.4.2.2.2	Visual indicator		N/A
8.5.4.2.3	Emergency stop system		N/A
	Maximum stopping distance from the point of activation (m).....:		N/A
	Space between end point and nearest fixed mechanical part (mm)		N/A
8.5.4.2.4	Endurance requirements		N/A
	Mechanical system subjected to 100 000 cycles of operation		N/A
	- Mechanical function check and visual inspection		N/A
	- Cable assembly		N/A
8.5.4.3	Equipment having electromechanical device for destruction of media		N/A
8.5.4.3.1	Equipment safeguards		N/A
8.5.4.3.2	Instructional safeguards against moving parts		N/A
8.5.4.3.3	Disconnection from the supply		N/A
8.5.4.3.4	Cut type and test force (N).....:		N/A
8.5.4.3.5	Compliance		N/A
8.5.5	High pressure lamps		N/A
	Explosion test.....:		N/A
8.5.5.3	Glass particles dimensions (mm)		N/A
8.6	Stability of equipment		N/A
8.6.1	General		N/A
	Instructional safeguard.....:		N/A
8.6.2	Static stability		N/A

IEC 62368-1			
Clause	Requirement + Test	Result - Remark	Verdict
8.6.2.2	Static stability test		N/A
8.6.2.3	Downward force test		N/A
8.6.3	Relocation stability		N/A
	Wheels diameter (mm)		—
	Tilt test		N/A
8.6.4	Glass slide test		N/A
8.6.5	Horizontal force test		N/A
8.7	Equipment mounted to wall, ceiling or other structure		N/A
8.7.1	Mount means type	See below.	N/A
8.7.2	Test methods		N/A
	Test 1, additional downwards force (N).....		N/A
	Test 2, number of attachment points and test force (N).....		N/A
	Test 3 Nominal diameter (mm) and applied torque (Nm).....		N/A
8.8	Handles strength		N/A
8.8.1	General		N/A
8.8.2	Handle strength test		N/A
	Number of handles.....		—
	Force applied (N)		—
8.9	Wheels or casters attachment requirements		N/A
8.9.2	Pull test		N/A
8.10	Carts, stands and similar carriers		N/A
8.10.1	General		N/A
8.10.2	Marking and instructions		N/A
8.10.3	Cart, stand or carrier loading test		N/A
	Loading force applied (N)		N/A
8.10.4	Cart, stand or carrier impact test		N/A
8.10.5	Mechanical stability		N/A
	Force applied (N)		—
8.10.6	Thermoplastic temperature stability		N/A
8.11	Mounting means for slide-rail mounted equipment (SRME)		N/A
8.11.1	General		N/A

IEC 62368-1			
Clause	Requirement + Test	Result - Remark	Verdict
8.11.2	Requirements for slide rails		N/A
	Instructional Safeguard.....:		N/A
8.11.3	Mechanical strength test		N/A
8.11.3.1	Downward force test, force (N) applied.....:		N/A
8.11.3.2	Lateral push force test		N/A
8.11.3.3	Integrity of slide rail end stops		N/A
8.11.4	Compliance		N/A
8.12	Telescoping or rod antennas		N/A
	Button/ball diameter (mm)		—

9	THERMAL BURN INJURY		P
9.2	Thermal energy source classifications		P
9.3	Touch temperature limits		P
9.3.1	Touch temperatures of accessible parts	(See appended table 5.4.1.4, 9.3, B.1.5, B.2.6)	P
9.3.2	Test method and compliance	(See appended table 5.4.1.4, 9.3, B.1.5, B.2.6)	P
9.4	Safeguards against thermal energy sources		N/A
9.5	Requirements for safeguards		N/A
9.5.1	Equipment safeguard		N/A
9.5.2	Instructional safeguard.....:		N/A
9.6	Requirements for wireless power transmitters		N/A
9.6.1	General		N/A
9.6.2	Specification of the foreign objects		N/A
9.6.3	Test method and compliance	(See appended table 9.6)	N/A

10	RADIATION		P
10.2	Radiation energy source classification		P
10.2.1	General classification		P
	Lasers	No Lasers	—
	Lamps and lamp systems	RS1, Indicating lights only	—
	Image projectors	No Image projectors	—
	X-Ray	No X-Ray	—

IEC 62368-1			
Clause	Requirement + Test	Result - Remark	Verdict
	Personal music player	No Personal music player	—
10.3	Safeguards against laser radiation		N/A
	The standard(s) equipment containing laser(s) comply		N/A
10.4	Safeguards against optical radiation from lamps and lamp systems (including LED types)		N/A
10.4.1	General requirements		N/A
	Instructional safeguard provided for accessible radiation level needs to exceed		N/A
	Risk group marking and location		N/A
	Information for safe operation and installation		N/A
10.4.2	Requirements for enclosures		N/A
	UV radiation exposure		N/A
10.4.3	Instructional safeguard		N/A
10.5	Safeguards against X-radiation		N/A
10.5.1	Requirements		N/A
	Instructional safeguard for skilled persons		—
10.5.3	Maximum radiation (pA/kg).....	(See appended tables B.3 & B.4)	—
10.6	Safeguards against acoustic energy sources		N/A
10.6.1	General		N/A
10.6.2	Classification		N/A
	Acoustic output $L_{Aeq,T}$, dB(A).....		N/A
	Unweighted RMS output voltage (mV).....		N/A
	Digital output signal (dBFS)		N/A
10.6.3	Requirements for dose-based systems		N/A
10.6.3.1	General requirements		N/A
10.6.3.2	Dose-based warning and automatic decrease		N/A
10.6.3.3	Exposure-based warning and requirements		N/A
	30 s integrated exposure level (MEL30)		N/A
	Warning for MEL \geq 100 dB(A)		N/A
10.6.4	Measurement methods		N/A
10.6.5	Protection of persons		N/A
	Instructional safeguards		N/A

IEC 62368-1			
Clause	Requirement + Test	Result - Remark	Verdict
10.6.6	Requirements for listening devices (headphones, earphones, etc.)		N/A
10.6.6.1	Corded listening devices with analogue input		N/A
	Listening device input voltage (mV)..... :		N/A
10.6.6.2	Corded listening devices with digital input		N/A
	Max. acoustic output $L_{Aeq,T}$, dB(A)		N/A
10.6.6.3	Cordless listening devices		N/A
	Max. acoustic output $L_{Aeq,T}$, dB(A)		N/A

B	NORMAL OPERATING CONDITION TESTS, ABNORMAL OPERATING CONDITION TESTS AND SINGLE FAULT CONDITION TESTS		P
B.1	General		P
B.1.5	Temperature measurement conditions	(See appended table B.1.5)	P
B.2	Normal operating conditions		P
B.2.1	General requirements..... :	(See Test Item Particulars and appended test tables)	P
	Audio Amplifiers and equipment with audio amplifiers		N/A
B.2.3	Supply voltage and tolerances	$\pm 10\%$	P
B.2.5	Input test..... :	(See appended table B.2.5)	P
B.3	Simulated abnormal operating conditions		P
B.3.1	General	(See appended table B.3)	P
B.3.2	Covering of ventilation openings		N/A
	Instructional safeguard		N/A
B.3.3	DC mains polarity test		N/A
B.3.4	Setting of voltage selector		N/A
B.3.5	Maximum load at output terminals	(See appended table B.3)	P
B.3.6	Reverse battery polarity		N/A
B.3.7	Audio amplifier abnormal operating conditions		N/A
B.3.8	Safeguards functional during and after abnormal operating conditions	(See appended table B.3)	P
B.4	Simulated single fault conditions		P
B.4.1	General		P
B.4.2	Temperature controlling device		N/A

IEC 62368-1			
Clause	Requirement + Test	Result - Remark	Verdict
B.4.3	Blocked motor test		N/A
B.4.4	Functional insulation		P
B.4.4.1	Short circuit of clearances for functional insulation		P
B.4.4.2	Short circuit of creepage distances for functional insulation		P
B.4.4.3	Short circuit of functional insulation on coated printed boards		N/A
B.4.5	Short-circuit and interruption of electrodes in tubes and semiconductors		P
B.4.6	Short circuit or disconnection of passive components		P
B.4.7	Continuous operation of components		N/A
B.4.8	Compliance during and after single fault conditions :	(See appended table B.4)	P
B.4.9	Battery charging and discharging under single fault conditions	(See Annex M)	N/A
C	UV RADIATION		N/A
C.1	Protection of materials in equipment from UV radiation		N/A
C.1.2	Requirements		N/A
C.1.3	Test method		N/A
C.2	UV light conditioning test		N/A
C.2.1	Test apparatus..... :		N/A
C.2.2	Mounting of test samples		N/A
C.2.3	Carbon-arc light-exposure test		N/A
C.2.4	Xenon-arc light-exposure test		N/A
D	TEST GENERATORS		N/A
D.1	Impulse test generators		N/A
D.2	Antenna interface test generator		N/A
D.3	Electronic pulse generator		N/A
E	TEST CONDITIONS FOR EQUIPMENT CONTAINING AUDIO AMPLIFIERS		N/A
E.1	Electrical energy source classification for audio signals		N/A
	Maximum non-clipped output power (W)..... :		—
	Rated load impedance (Ω) :		—
	Open-circuit output voltage (V)..... :		—
	Instructional safeguard :	See Clause F.5	—

IEC 62368-1			
Clause	Requirement + Test	Result - Remark	Verdict
E.2	Audio amplifier normal operating conditions		N/A
	Audio signal source type		—
	Audio output power (W)		—
	Audio output voltage (V)		—
	Rated load impedance (Ω)		—
	Requirements for temperature measurement	(See Table B.1.5)	N/A
E.3	Audio amplifier abnormal operating conditions	(See Table B.3, B.4)	N/A
F	EQUIPMENT MARKINGS, INSTRUCTIONS, AND INSTRUCTIONAL SAFEGUARDS		P
F.1	General		P
	Language	English.	—
F.2	Letter symbols and graphical symbols		P
F.2.1	Letter symbols according to IEC60027-1		P
F.2.2	Graphic symbols according to IEC, ISO or manufacturer specific		P
F.3	Equipment markings		P
F.3.1	Equipment marking locations		P
F.3.2	Equipment identification markings		P
F.3.2.1	Manufacturer identification	See copy of marking plate.	P
F.3.2.2	Model identification	See copy of marking plate.	P
F.3.3	Equipment rating markings		P
F.3.3.1	Equipment with direct connection to mains		P
F.3.3.2	Equipment without direct connection to mains		N/A
F.3.3.3	Nature of the supply voltage	See copy of marking plate	P
F.3.3.4	Rated voltage	See copy of marking plate	P
F.3.3.5	Rated frequency	See copy of marking plate	P
F.3.3.6	Rated current or rated power	See copy of marking plate	P
F.3.3.7	Equipment with multiple supply connections		N/A
F.3.4	Voltage setting device		N/A
F.3.5	Terminals and operating devices		P
F.3.5.1	Mains appliance outlet and socket-outlet markings		N/A
F.3.5.2	Switch position identification marking		N/A

IEC 62368-1			
Clause	Requirement + Test	Result - Remark	Verdict
F.3.5.3	Replacement fuse identification and rating markings	The fuse is located within the equipment and not replaceable by an ordinary person or an instructed person. The fuse is marked with F1, F2: T3.15A 250V	P
	Instructional safeguards for neutral fuse		N/A
F.3.5.4	Replacement battery identification marking		N/A
F.3.5.5	Neutral conductor terminal		P
F.3.5.6	Terminal marking location		P
F.3.6	Equipment markings related to equipment classification		P
F.3.6.1	Class I equipment	For class I equipment	P
F.3.6.1.1	Protective earthing conductor terminal	For models GT**-*** T3/T3A/R3A/F/P3**	P
F.3.6.1.2	Protective bonding conductor terminals		N/A
F.3.6.2	Equipment class marking	For models GT**-***- T2/T2A/R2/FW/P2** GTM91128LI*CEL**_**** and GTM91128***_**** and GTM91128LI1CEL, GTM91128LI2CEL, GTM91128LI3CEL The symbol  on the label.	P
F.3.6.3	Functional earthing terminal marking		N/A
F.3.7	Equipment IP rating marking		N/A
F.3.8	External power supply output marking	See copy of marking plate	P
F.3.9	Durability, legibility and permanence of marking	See below	P
F.3.10	Test for permanence of markings	Marking is durable and legible. The marking plate has no curling and is not able to be removed easily.	P
F.4	Instructions		P
	a) Information prior to installation and initial use		P
	b) Equipment for use in locations where children not likely to be present	Provided in user manual.	P
	c) Instructions for installation and interconnection		N/A
	d) Equipment intended for use only in restricted access area		N/A
	e) Equipment intended to be fastened in place		N/A

IEC 62368-1			
Clause	Requirement + Test	Result - Remark	Verdict
	f) Instructions for audio equipment terminals		N/A
	g) Protective earthing used as a safeguard		P
	h) Protective conductor current exceeding ES2 limits		N/A
	i) Graphic symbols used on equipment		P
	j) Permanently connected equipment not provided with all-pole mains switch		N/A
	k) Replaceable components or modules providing safeguard function		N/A
	l) Equipment containing insulating liquid		N/A
	m) Installation instructions for outdoor equipment		N/A
F.5	Instructional safeguards		N/A
G	COMPONENTS		P
G.1	Switches		N/A
G.1.1	General		N/A
G.1.2	Ratings, endurance, spacing, maximum load		N/A
G.1.3	Test method and compliance		N/A
G.2	Relays		N/A
G.2.1	Requirements		N/A
G.2.2	Overload test		N/A
G.2.3	Relay controlling connectors supplying power to other equipment		N/A
G.2.4	Test method and compliance		N/A
G.3	Protective devices		P
G.3.1	Thermal cut-offs		N/A
	Thermal cut-outs separately approved according to IEC 60730 with conditions indicated in a) & b)		N/A
	Thermal cut-outs tested as part of the equipment as indicated in c)		N/A
G.3.1.2	Test method and compliance		N/A
G.3.2	Thermal links		N/A
G.3.2.1	a) Thermal links tested separately according to IEC 60691 with specifics		N/A
	b) Thermal links tested as part of the equipment		N/A
G.3.2.2	Test method and compliance		N/A

IEC 62368-1			
Clause	Requirement + Test	Result - Remark	Verdict
G.3.3	PTC thermistors		N/A
G.3.4	Overcurrent protection devices		P
G.3.5	Safeguards components not mentioned in G.3.1 to G.3.4		N/A
G.3.5.1	Non-resettable devices suitably rated and marking provided		N/A
G.3.5.2	Single faults conditions..... :	(See appended table B.4)	N/A
G.4	Connectors		P
G.4.1	Spacings	The appliance inlet complied with IEC 60320-1.	P
G.4.2	Mains connector configuration :	The appliance inlet complied with IEC 60320-1.	P
G.4.3	Plug is shaped that insertion into mains socket-outlets or appliance coupler is unlikely		P
G.5	Wound components		P
G.5.1	Wire insulation in wound components	Approved TIW used for primary and secondary winding of transformer.	P
G.5.1.2	Protection against mechanical stress		P
G.5.2	Endurance test		N/A
G.5.2.1	General test requirements		N/A
G.5.2.2	Heat run test		N/A
	Test time (days per cycle) :		—
	Test temperature (°C)..... :		—
G.5.2.3	Wound components supplied from the mains		N/A
G.5.2.4	No insulation breakdown		N/A
G.5.3	Transformers		P
G.5.3.1	Compliance method..... :	Meet the requirements in G.5.3.2 and G.5.3.3.	P
	Position :	T1	P
	Method of protection..... :	TIW used.	P
G.5.3.2	Insulation		P
	Protection from displacement of windings..... :	Primary windings and secondary windings are separated by Reinforced insulation (The core is considered as primary part as it is not isolated from Primary)	P

IEC 62368-1			
Clause	Requirement + Test	Result - Remark	Verdict
G.5.3.3	Transformer overload tests	(See appended table B.3 & B.4)	P
G.5.3.3.1	Test conditions	Tested in the complete equipment.	P
G.5.3.3.2	Winding temperatures	(See appended table B.3 & B.4)	P
G.5.3.3.3	Winding temperatures - alternative test method		N/A
G.5.3.4	Transformers using FIW		N/A
G.5.3.4.1	General		N/A
	FIW wire nominal diameter..... :		N/A
G.5.3.4.2	Transformers with basic insulation only		N/A
G.5.3.4.3	Transformers with double insulation or reinforced insulation..... :	Meet the requirements	P
G.5.3.4.4	Transformers with FIW wound on metal or ferrite core		N/A
G.5.3.4.5	Thermal cycling test and compliance		N/A
G.5.3.4.6	Partial discharge test		N/A
G.5.3.4.7	Routine test		N/A
G.5.4	Motors		N/A
G.5.4.1	General requirements		N/A
G.5.4.2	Motor overload test conditions		N/A
G.5.4.3	Running overload test		N/A
G.5.4.4.2	Locked-rotor overload test		N/A
	Test duration (days) :		—
G.5.4.5	Running overload test for DC motors		N/A
G.5.4.5.2	Tested in the unit		N/A
G.5.4.5.3	Alternative method		N/A
G.5.4.6	Locked-rotor overload test for DC motors		N/A
G.5.4.6.2	Tested in the unit		N/A
	Maximum Temperature :		N/A
G.5.4.6.3	Alternative method		N/A
G.5.4.7	Motors with capacitors		N/A
G.5.4.8	Three-phase motors		N/A
G.5.4.9	Series motors		N/A
	Operating voltage :		—
G.6	Wire Insulation		P

IEC 62368-1			
Clause	Requirement + Test	Result - Remark	Verdict
G.6.1	General	Triple insulated winding in T1 secondary windings used as reinforced safeguard in the isolating transformer that has separately complied with Annex J. See Appended table 4.1.2. No other wires used in the EUT.	P
G.6.2	Enamelled winding wire insulation		N/A
G.7	Mains supply cords		N/A
G.7.1	General requirements		N/A
	Type..... :		—
G.7.2	Cross sectional area (mm ² or AWG) :		N/A
G.7.3	Cord anchorages and strain relief for non-detachable power supply cords		N/A
G.7.3.2	Cord strain relief		N/A
G.7.3.2.1	Requirements		N/A
	Strain relief test force (N)..... :		N/A
G.7.3.2.2	Strain relief mechanism failure		N/A
G.7.3.2.3	Cord sheath or jacket position, distance (mm) :		N/A
G.7.3.2.4	Strain relief and cord anchorage material		N/A
G.7.4	Cord Entry		N/A
G.7.5	Non-detachable cord bend protection		N/A
G.7.5.1	Requirements		N/A
G.7.5.2	Test method and compliance		N/A
	Overall diameter or minor overall dimension, <i>D</i> (mm) :		—
	Radius of curvature after test (mm) :		—
G.7.6	Supply wiring space		N/A
G.7.6.1	General requirements		N/A
G.7.6.2	Stranded wire		N/A
G.7.6.2.1	Requirements		N/A
G.7.6.2.2	Test with 8 mm strand		N/A
G.8	Varistors		P
G.8.1	General requirements	Approve components, see table 4.1.2 for the details.	P
G.8.2	Safeguards against fire		N/A

IEC 62368-1			
Clause	Requirement + Test	Result - Remark	Verdict
G.8.2.1	General		N/A
G.8.2.2	Varistor overload test		N/A
G.8.2.3	Temporary overvoltage test		N/A
G.9	Integrated circuit (IC) current limiters		N/A
G.9.1	Requirements		N/A
	IC limiter output current (max. 5A)		—
	Manufacturers' defined drift		—
G.9.2	Test Program		N/A
G.9.3	Compliance		N/A
G.10	Resistors		N/A
G.10.1	General		N/A
G.10.2	Conditioning		N/A
G.10.3	Resistor test		N/A
G.10.4	Voltage surge test		N/A
G.10.5	Impulse test		N/A
G.10.6	Overload test		N/A
G.11	Capacitors and RC units		P
G.11.1	General requirements	X-Capacitors and Y-Capacitors used as safeguard and complied with IEC/EN 60384-14. (See appended table 4.1.2)	P
G.11.2	Conditioning of capacitors and RC units		P
G.11.3	Rules for selecting capacitors		P
G.12	Optocouplers		P
	Optocouplers comply with IEC 60747-5-5 with specifics	The optocouplers used in the equipment are complied with IEC/EN 60747-5-5. (See appended table 4.1.2)	P
	Type test voltage $V_{ini,a}$	See above.	—
	Routine test voltage, $V_{ini,b}$	See above.	—
G.13	Printed boards		P
G.13.1	General requirements	See below.	P
G.13.2	Uncoated printed boards	See appended table 5.4.2.2, 5.4.2.4 and 5.4.3	P
G.13.3	Coated printed boards		N/A

IEC 62368-1			
Clause	Requirement + Test	Result - Remark	Verdict
G.13.4	Insulation between conductors on the same inner surface		N/A
G.13.5	Insulation between conductors on different surfaces		N/A
	Distance through insulation :		N/A
	Number of insulation layers (pcs) :		—
G.13.6	Tests on coated printed boards		N/A
G.13.6.1	Sample preparation and preliminary inspection		N/A
G.13.6.2	Test method and compliance		N/A
G.14	Coating on components terminals		N/A
G.14.1	Requirements :	(See Clause G.13)	N/A
G.15	Pressurized liquid filled components		N/A
G.15.1	Requirements		N/A
G.15.2	Test methods and compliance		N/A
G.15.2.1	Hydrostatic pressure test		N/A
G.15.2.2	Creep resistance test		N/A
G.15.2.3	Tubing and fittings compatibility test		N/A
G.15.2.4	Vibration test		N/A
G.15.2.5	Thermal cycling test		N/A
G.15.2.6	Force test		N/A
G.15.3	Compliance		N/A
G.16	IC including capacitor discharge function (ICX)		N/A
G.16.1	Condition for fault tested is not required		N/A
	ICX with associated circuitry tested in equipment		N/A
	ICX tested separately		N/A
G.16.2	Tests		N/A
	Smallest capacitance and smallest resistance specified by ICX manufacturer for impulse test..... :		—
	Mains voltage that impulses to be superimposed on :		—
	Largest capacitance and smallest resistance for ICX tested by itself for 10000 cycles test :		—
G.16.3	Capacitor discharge test..... :		N/A
H	CRITERIA FOR TELEPHONE RINGING SIGNALS		N/A
H.1	General		N/A

IEC 62368-1			
Clause	Requirement + Test	Result - Remark	Verdict
H.2	Method A		N/A
H.3	Method B		N/A
H.3.1	Ringling signal		N/A
H.3.1.1	Frequency (Hz)		—
H.3.1.2	Voltage (V)		—
H.3.1.3	Cadence; time (s) and voltage (V)		—
H.3.1.4	Single fault current (mA):.....		—
H.3.2	Tripping device and monitoring voltage		N/A
H.3.2.1	Conditions for use of a tripping device or a monitoring voltage		N/A
H.3.2.2	Tripping device		N/A
H.3.2.3	Monitoring voltage (V)		N/A
J	INSULATED WINDING WIRES FOR USE WITHOUT INTERLEAVED INSULATION		P
J.1	General		P
	Winding wire insulation.....	Approved TRIPLE INSULATION WIRE	—
	Solid round winding wire, diameter (mm)		N/A
	Solid square and rectangular (flatwise bending) winding wire, cross-sectional area (mm ²).....		N/A
J.2/J.3	Tests and Manufacturing		—
K	SAFETY INTERLOCKS		N/A
K.1	General requirements		N/A
	Instructional safeguard		N/A
K.2	Components of safety interlock safeguard mechanism		N/A
K.3	Inadvertent change of operating mode		N/A
K.4	Interlock safeguard override		N/A
K.5	Fail-safe		N/A
K.5.1	Under single fault condition		N/A
K.6	Mechanically operated safety interlocks		N/A
K.6.1	Endurance requirement		N/A
K.6.2	Test method and compliance		N/A
K.7	Interlock circuit isolation		N/A
K.7.1	Separation distance for contact gaps & interlock circuit elements		N/A

IEC 62368-1			
Clause	Requirement + Test	Result - Remark	Verdict
	In circuit connected to mains, separation distance for contact gaps (mm)..... :		N/A
	In circuit isolated from mains, separation distance for contact gaps (mm)..... :		N/A
	Electric strength test before and after the test of K.7.2		N/A
K.7.2	Overload test, Current (A)		N/A
K.7.3	Endurance test		N/A
K.7.4	Electric strength test		N/A
L	DISCONNECT DEVICES		P
L.1	General requirements	Appliance Inlet as disconnect device.	P
L.2	Permanently connected equipment		N/A
L.3	Parts that remain energized	When the power cord is removed from the inlet no remaining parts with hazardous voltage in the equipment.	P
L.4	Single-phase equipment	The disconnect device disconnects both poles simultaneously.	P
L.5	Three-phase equipment		N/A
L.6	Switches as disconnect devices		N/A
L.7	Plugs as disconnect devices		N/A
L.8	Multiple power sources		N/A
	Instructional safeguard		N/A
M	EQUIPMENT CONTAINING BATTERIES AND THEIR PROTECTION CIRCUITS		N/A
M.1	General requirements		N/A
M.2	Safety of batteries and their cells		N/A
M.2.1	Batteries and their cells comply with relevant IEC standards		N/A
M.3	Protection circuits for batteries provided within the equipment		N/A
M.3.1	Requirements		N/A
M.3.2	Test method		N/A
	Overcharging of a rechargeable battery		N/A
	Excessive discharging		N/A
	Unintentional charging of a non-rechargeable battery		N/A

IEC 62368-1			
Clause	Requirement + Test	Result - Remark	Verdict
	Reverse charging of a rechargeable battery		N/A
M.3.3	Compliance	(See appended table M.3)	N/A
M.4	Additional safeguards for equipment containing a portable secondary lithium battery		N/A
M.4.1	General		N/A
M.4.2	Charging safeguards		N/A
M.4.2.1	Requirements		N/A
M.4.2.2	Compliance..... :	(See appended table M.4.2)	N/A
M.4.3	Fire enclosure..... :		N/A
M.4.4	Drop test of equipment containing a secondary lithium battery		N/A
M.4.4.2	Preparation and procedure for the drop test		N/A
M.4.4.3	Drop, Voltage on reference and dropped batteries (V); voltage difference during 24 h period (%): :		N/A
M.4.4.4	Check of the charge/discharge function		N/A
M.4.4.5	Charge / discharge cycle test		N/A
M.4.4.6	Compliance		N/A
M.5	Risk of burn due to short-circuit during carrying		N/A
M.5.1	Requirement		N/A
M.5.2	Test method and compliance		N/A
M.6	Safeguards against short-circuits		N/A
M.6.1	External and internal faults		N/A
M.6.2	Compliance		N/A
M.7	Risk of explosion from lead acid and NiCd batteries		N/A
M.7.1	Ventilation preventing explosive gas concentration		N/A
	Calculated hydrogen generation rate :		N/A
M.7.2	Test method and compliance		N/A
	Minimum air flow rate, Q (m ³ /h)..... :		N/A
M.7.3	Ventilation tests		N/A
M.7.3.1	General		N/A
M.7.3.2	Ventilation test – alternative 1		N/A
	Hydrogen gas concentration (%) :		N/A
M.7.3.3	Ventilation test – alternative 2		N/A
	Obtained hydrogen generation rate..... :		N/A

IEC 62368-1			
Clause	Requirement + Test	Result - Remark	Verdict
M.7.3.4	Ventilation test – alternative 3		N/A
	Hydrogen gas concentration (%)		N/A
M.7.4	Marking		N/A
M.8	Protection against internal ignition from external spark sources of batteries with aqueous electrolyte		N/A
M.8.1	General		N/A
M.8.2	Test method		N/A
M.8.2.1	General		N/A
M.8.2.2	Estimation of hypothetical volume V_z (m ³ /s)		—
M.8.2.3	Correction factors		—
M.8.2.4	Calculation of distance d (mm)		—
M.9	Preventing electrolyte spillage		N/A
M.9.1	Protection from electrolyte spillage		N/A
M.9.2	Tray for preventing electrolyte spillage		N/A
M.10	Instructions to prevent reasonably foreseeable misuse		N/A
	Instructional safeguard		N/A
N	ELECTROCHEMICAL POTENTIALS		P
	Material(s) used	Considered	—
O	MEASUREMENT OF CREEPAGE DISTANCES AND CLEARANCES		P
	Value of X (mm)	Considered	—
P	SAFEGUARDS AGAINST CONDUCTIVE OBJECTS		P
P.1	General		P
P.2	Safeguards against entry or consequences of entry of a foreign object		P
P.2.1	General	No opening.	P
P.2.2	Safeguards against entry of a foreign object		N/A
	Location and Dimensions (mm)		—
P.2.3	Safeguards against the consequences of entry of a foreign object		N/A
P.2.3.1	Safeguard requirements		N/A
	The ES3 and PS3 keep-out volume in Figure P.3 not applicable to transportable equipment		N/A
	Transportable equipment with metalized plastic parts		N/A

IEC 62368-1			
Clause	Requirement + Test	Result - Remark	Verdict
P.2.3.2	Consequence of entry test..... :		N/A
P.3	Safeguards against spillage of internal liquids		N/A
P.3.1	General		N/A
P.3.2	Determination of spillage consequences		N/A
P.3.3	Spillage safeguards		N/A
P.3.4	Compliance		N/A
P.4	Metallized coatings and adhesives securing parts		N/A
P.4.1	General		N/A
P.4.2	Tests		N/A
	Conditioning, T _c (°C)		—
	Duration (weeks)		—
Q	CIRCUITS INTENDED FOR INTERCONNECTION WITH BUILDING WIRING		P
Q.1	Limited power sources		P
Q.1.1	Requirements		P
	a) Inherently limited output		N/A
	b) Impedance limited output	(See appended table Annex Q.1)	P
	c) Regulating network limited output		N/A
	d) Overcurrent protective device limited output		N/A
	e) IC current limiter complying with G.9		N/A
Q.1.2	Test method and compliance	(See appended table Q.1)	P
	Current rating of overcurrent protective device (A)		N/A
Q.2	Test for external circuits – paired conductor cable		N/A
	Maximum output current (A)		N/A
	Current limiting method		—
R	LIMITED SHORT CIRCUIT TEST		N/A
R.1	General		N/A
R.2	Test setup		N/A
	Overcurrent protective device for test		—
R.3	Test method		N/A
	Cord/cable used for test		—
R.4	Compliance		N/A

IEC 62368-1			
Clause	Requirement + Test	Result - Remark	Verdict
S	TESTS FOR RESISTANCE TO HEAT AND FIRE		N/A
S.1	Flammability test for fire enclosures and fire barrier materials of equipment where the steady state power does not exceed 4 000 W		N/A
	Samples, material..... :		—
	Wall thickness (mm)		—
	Conditioning (°C)		—
	Test flame according to IEC 60695-11-5 with conditions as set out		N/A
	- Material not consumed completely		N/A
	- Material extinguishes within 30s		N/A
	- No burning of layer or wrapping tissue		N/A
S.2	Flammability test for fire enclosure and fire barrier integrity		N/A
	Samples, material..... :		—
	Wall thickness (mm)		—
	Conditioning (°C)		—
S.3	Flammability test for the bottom of a fire enclosure		N/A
S.3.1	Mounting of samples		N/A
S.3.2	Test method and compliance		N/A
	Mounting of samples		—
	Wall thickness (mm)		—
S.4	Flammability classification of materials		N/A
S.5	Flammability test for fire enclosure materials of equipment with a steady state power exceeding 4 000 W		N/A
	Samples, material..... :		—
	Wall thickness (mm)		—
	Conditioning (°C)		—
T	MECHANICAL STRENGTH TESTS		P
T.1	General		P
T.2	Steady force test, 10 N	(See appended table T.2)	P
T.3	Steady force test, 30 N	(See appended table T.3)	N/A
T.4	Steady force test, 100 N	(See appended table T.4)	N/A
T.5	Steady force test, 250 N	(See appended table T.5)	P
T.6	Enclosure impact test	(See appended table T.6)	P

IEC 62368-1			
Clause	Requirement + Test	Result - Remark	Verdict
	Fall test		N/A
	Swing test		N/A
T.7	Drop test	(See appended table T.7)	P
T.8	Stress relief test	(See appended table T.8)	P
T.9	Glass Impact Test	(See appended table T.9)	N/A
T.10	Glass fragmentation test		N/A
	Number of particles counted.....		N/A
T.11	Test for telescoping or rod antennas		N/A
	Torque value (Nm)		N/A
U	MECHANICAL STRENGTH OF CATHODE RAY TUBES (CRT) AND PROTECTION AGAINST THE EFFECTS OF IMPLOSION		N/A
U.1	General		N/A
	Instructional safeguard :		N/A
U.2	Test method and compliance for non-intrinsically protected CRTs		N/A
U.3	Protective screen		N/A
V	DETERMINATION OF ACCESSIBLE PARTS		P
V.1	Accessible parts of equipment		P
V.1.1	General		P
V.1.2	Surfaces and openings tested with jointed test probes		P
V.1.3	Openings tested with straight unjointed test probes		N/A
V.1.4	Plugs, jacks, connectors tested with blunt probe		N/A
V.1.5	Slot openings tested with wedge probe		N/A
V.1.6	Terminals tested with rigid test wire		N/A
V.2	Accessible part criterion		N/A
X	ALTERNATIVE METHOD FOR DETERMINING CLEARANCES FOR INSULATION IN CIRCUITS CONNECTED TO AN AC MAINS NOT EXCEEDING 420 V PEAK (300 V RMS)		N/A
	Clearance	(See appended table X)	N/A
Y	CONSTRUCTION REQUIREMENTS FOR OUTDOOR ENCLOSURES		N/A
Y.1	General		N/A
Y.2	Resistance to UV radiation		N/A
Y.3	Resistance to corrosion		N/A
Y.3	Resistance to corrosion		N/A

IEC 62368-1			
Clause	Requirement + Test	Result - Remark	Verdict
Y.3.1	Metallic parts of outdoor enclosures are resistant to effects of water-borne contaminants by :		N/A
Y.3.2	Test apparatus		N/A
Y.3.3	Water – saturated sulphur dioxide atmosphere		N/A
Y.3.4	Test procedure :		N/A
Y.3.5	Compliance		N/A
Y.4	Gaskets		N/A
Y.4.1	General		N/A
Y.4.2	Gasket tests		N/A
Y.4.3	Tensile strength and elongation tests		N/A
	Alternative test methods :		N/A
Y.4.4	Compression test		N/A
Y.4.5	Oil resistance		N/A
Y.4.6	Securing means	(See Annex P.4)	N/A
Y.5	Protection of equipment within an outdoor enclosure		N/A
Y.5.1	General		N/A
Y.5.2	Protection from moisture		N/A
	Relevant tests of IEC 60529 or Y.5.3 :		N/A
Y.5.3	Water spray test		N/A
Y.5.4	Protection from plants and vermin		N/A
Y.5.5	Protection from excessive dust		N/A
Y.5.5.1	General		N/A
Y.5.5.2	IP5X equipment		N/A
Y.5.5.3	IP6X equipment		N/A
Y.6	Mechanical strength of enclosures		N/A
Y.6.1	General		N/A
Y.6.2	Impact test :	(See Table T.6)	N/A

IEC 62368-1			
Clause	Requirement + Test	Result - Remark	Verdict

5.2	TABLE: Classification of electrical energy sources					P	
Supply Voltage	Location (e.g. circuit designation)	Test conditions	Parameters				ES Class
			U (V)	I (mA)	Type ¹⁾	Additional Info ²⁾	
264V,60Hz	Primary circuit (for all models)	Normal	264	--	--	--	ES3
		Abnormal	264	--	--	--	
		Single fault – SC/OC	264	--	--	--	
264V,60Hz	Sec. output + to -	Normal	48.1 Vdc	--	SS	--	ES1
		Abnormal	48.1 Vdc	--	SS	--	
		Single fault – T1 sec. (SC)	0	--	SS	--	

5.2.2.3 - Capacitance Limits

Supply Voltage	Location (e.g. circuit designation)	Test conditions	Parameters		ES Class
			Capacitance, nF	Upk (V)	
264V,60Hz	C4	Normal	2200uF	48.1Vdc	ES1
		Abnormal – output (OL)	2200uF	47.8Vdc	
		Single fault - SC	2200uF	0.2Vdc	

Supplementary information:

1) Type: Steady state (SS), Capacitance (CP), Single pulse (SP), Repetitive pulses (RP), etc.
 2) Additional Info: Frequency, Pulse duration, Pulse off time, Capacitance value, etc.
 Note: Max. values are recorded in this report.

5.4.1.8	TABLE: Working voltage measurement				P
Location	RMS voltage (V)	Peak voltage (V)	Frequency (Hz)	Comments	
--	--	--	--	--	

Supplementary information:

Note: Max. values are recorded in this report.

5.4.1.10.2	TABLE: Vicat softening temperature of thermoplastics			N/A
Method.....:	--			—
Object/ Part No./Material	Manufacturer/trademark	Thickness (mm)	T softening (°C)	
--	--	--	--	

IEC 62368-1			
Clause	Requirement + Test	Result - Remark	Verdict

Supplementary information:

5.4.1.10.3 TABLE: Ball pressure test of thermoplastics					P
Allowed impression diameter (mm): ≤ 2 mm					—
Object/Part No./Material	Manufacturer/trademark	Thickness (mm)	Test temperature (°C)	Impression diameter (mm)	
Enclosure (SE1, SE1X)	SABIC INNOVATIVE PLASTICS B V; SABIC JAPAN L L C	3.0	125	1.5	
Enclosure (SE100)	SABIC INNOVATIVE PLASTICS B V; SABIC JAPAN L L C	3.0	125	1.6	
Enclosure (C2950)	SABIC INNOVATIVE PLASTICS B V; SABIC JAPAN L L C	3.0	125	1.7	
Enclosure (CX7211, EXCY0098)	SABIC INNOVATIVE PLASTICS B V; SABIC JAPAN L L C	3.0	125	1.8	
Enclosure (945)	SABIC INNOVATIVE PLASTICS B V; SABIC JAPAN L L C; SABIC INNOVATIVE PLASTICS US L L C	3.0	125	1.4	
Enclosure (HF500R)	SABIC INNOVATIVE PLASTICS B V; SABIC JAPAN L L C	3.0	125	1.4	
Enclosure (LN-1250P, LN-1250G)	TEIJIN CHEMICALS LTD	3.0	125	1.5	
Supplementary information:					
The bobbin material of transformer (T1) are phenolic, no test is needed.					

5.4.2, 5.4.3 TABLE: Minimum Clearances/Creepage distance								P
Clearance (cl) and creepage distance (cr) at/of/between:	U _p (V)	U _{rms} (V)	Freq ¹⁾ (Hz)	Required cl (mm)	cl (mm)	E.S. ²⁾ (V)	Required cr (mm)	cr (mm)
GTM96180 series								
L to N before fuse(FI)	2000	240	--	2.3	3.75	--	2.5	3.75
Two poles of fuse(FI)	2000	240	--	2.3	2.70	--	2.5	2.70

IEC 62368-1								
Clause	Requirement + Test				Result - Remark			Verdict
Primary to protective earth (Class I)(RI)	2000	240	--	4.5	6.10	--	5.0	6.10
Live parts to accessible parts(RI)	2000	240	--	4.5	8.20	--	5.0	8.20
Primary circuits to secondary circuits(RI)	2000	240	--	4.5	6.53	--	5.0	6.53
Primary winding to secondary winding(RI)	2000	240	--	4.5	6.50	--	5.0	6.50
Secondary winding to core(RI)	2000	240	--	4.5	7.20	--	5.0	7.20
Core to secondary parts(RI)	2000	240	--	4.5	7.10	--	5.0	7.10
GTM96300 series								
L to N before fuse(FI)	2000	240	--	2.3	7.12	--	2.5	7.12
Two poles of fuse(FI)	2000	240	--	2.3	2.60	--	2.5	2.60
Primary to protective earth (Class I)(RI)	2000	240	--	4.5	6.10	--	5.0	6.10
Live parts to accessible parts(RI)	2000	240	--	4.5	8.20	--	5.0	8.20
Primary circuits to secondary circuits(RI)	2000	240	--	4.5	6.66	--	5.0	6.66
Primary winding to secondary winding(RI)	2000	240	--	4.5	7.20	--	5.0	7.20
Secondary winding to core(RI)	2000	240	--	4.5	6.85	--	5.0	6.85
Core to secondary parts(RI)	2000	240	--	4.5	7.10	--	5.0	7.10
GTM91120series								
L to N before fuse(FI)	2000	240	--	2.3	4.60	--	2.5	4.60
Two poles of fuse(FI)	2000	240	--	2.3	2.62	--	2.5	2.62
Primary to protective earth (Class I)(RI)	2000	240	--	4.5	6.10	--	5.0	6.10
Live parts to accessible parts(RI)	2000	240	--	4.5	8.20	--	5.0	8.20
Primary circuits to secondary circuits(RI)	2000	240	--	4.5	7.70	--	5.0	7.70
Primary winding to secondary winding(RI)	2000	240	--	4.5	8.40	--	5.0	8.40

IEC 62368-1								
Clause	Requirement + Test				Result - Remark			Verdict
Secondary winding to core(RI)	2000	240	--	4.5	6.85	--	5.0	6.85
Core to secondary parts(RI)	2000	240	--	4.5	7.10	--	5.0	7.10
GTM91128 series								
L to N before fuse(FI)	2000	240	--	2.3	4.20	--	2.5	4.20
Two poles of fuse(FI)	2000	240	--	2.3	4.30	--	2.5	4.30
Live parts to accessible parts(RI)	2000	240	--	4.5	7.25	--	5.0	7.25
Primary circuits to secondary circuits(RI)	2000	240	--	4.5	7.25	--	5.0	7.25
Primary winding to secondary winding(RI)	2000	240	--	4.5	13.00	--	5.0	13.00
Secondary winding to core(RI)	2000	240	--	4.5	12.50	--	5.0	12.50
Core to secondary parts(RI)	2000	240	--	4.5	9.28	--	5.0	9.28
Supplementary information:								
Note 1: Only for frequency above 30 kHz Note 2: See table 5.4.2.4 if this is based on electric strength test Note 3: Provide Material Group FI: Function insulation; BI: Basic insulation; RI: Reinforced insulation With the equipment to be operated at 5000m above sea level max. the minimum clearances is multiplied by the factor 1.48.								

5.4.4.2	TABLE: Minimum distance through insulation				P
Distance through insulation (DTI) at/of	Peak voltage (V)	Insulation	Required DTI (mm)	Measured DTI (mm)	
Enclosure	2000	Reinforced	0.4	Min. 2.0	
Bobbin of T1	2000	Reinforced	0.4	Min. 0.45	
Insulation tape on T1 and secondary heat-sink	2000	Reinforced	0.4	See appended table 4.1.2	
Insulation sheet	2000	Reinforced	0.4	See appended table 4.1.2	
Supplementary information:					

IEC 62368-1			
Clause	Requirement + Test	Result - Remark	Verdict

5.4.4.9	TABLE: Solid insulation at frequencies >30 kHz					N/A
Insulation material	E_P	Frequency (kHz)	K_R	Thickness d (mm)	Insulation	V_{PW} (Vpk)
--	--	--	--	--	--	--
Supplementary information:						

5.4.9	TABLE: Electric strength tests			P
Test voltage applied between:	Voltage shape (Surge, Impulse, AC, DC, etc.)	Test voltage (V)	Breakdown Yes / No	
Basic/supplementary:				
Line to Neutral (with fuse disconnect)	DC	2500V	No	
Reinforced:				
Primary circuit to body (RI)	DC	4000V	No	
Primary circuit to protective earth(RI)	DC	4000V	No	
Primary circuit to secondary circuit (RI)	DC	4000V	No	
Primary winding to secondary winding of T1 (RI)	DC	4000V	No	
Primary winding to core (RI)	DC	4000V	No	
Insulation tape around transformer per layer (RI)	DC	4000V	No	
Insulation sheet (RI)	DC	4000V	No	
Supplementary information:				
Note: The tests mentioned above were performed after humidity test.				

5.5.2.2	TABLE: Stored discharge on capacitors				P
Location	Supply voltage (V)	Operating and fault condition ¹⁾	Switch position	Measured voltage (Vpk)	ES Class
Line-Neutral	264V	N	--	24V	ES1
Line-Neutral	264V	S(R1 open)	--	120V	ES2
Supplementary information:					
X-capacitors installed for testing: CX1: 0.47uF					
[X] bleeding resistor rating: R1, R2: each 1MΩ					
[] ICX:					
1) Normal operating condition (e.g., normal operation, or open fuse), SC= short circuit, OC= open circuit					
All models have been considered and the maximum value has been recorded.					

IEC 62368-1			
Clause	Requirement + Test	Result - Remark	Verdict

5.6.6	TABLE: Resistance of protective conductors and terminations				P
Location	Test current (A)	Duration (min)	Voltage drop (V)	Resistance (Ω)	
AC inlet inside to outside	40	2	0.45	0.010	
Supplementary information:					
Tested with model GTM96300-3648-T3A					

5.7.4	TABLE: Unearthed accessible parts					P
Location	Operating and fault conditions	Supply Voltage (V)	Parameters			ES class
			Voltage (V _{rms} or V _{pk})	Current (A _{rms} or A _{pk})	Freq. (Hz)	
All unearthed accessible conductive parts (plastic enclosure /output port)	(See table B.2, B.3, B.4 for details, maximum result recorded)	264V,60Hz	--	0.176mApk		ES1
			--	0.176mApk		
			--	0.176mApk		
Supplementary information:						
Abbreviation: SC= short circuit; OC= open circuit						

5.7.5	TABLE: Earthed accessible conductive part			P
Supply voltage (V)	264V ac			—
Phase(s)	[X] Single Phase; [] Three Phase: [] Delta [] Wye			
Power Distribution System	[X] TN [] TT [] IT			
Location	Fault Condition No in IEC 60990 clause 6.2.2	Touch current (mA)	Comment	
Between PE terminal of AC inlet to protective earthing conductor (earthing wire)	1 (earth open)	0.143	ES1	
	2 (neutral open)	0.122	ES1	
Supplementary Information:				
Tested with normal, abnormal and single-fault condition, and maximum value was recorded.				

5.8	TABLE: Backfeed safeguard in battery backed up supplies					N/A
Location	Supply voltage (V)	Operating and fault condition	Time (s)	Open-circuit voltage (V)	Touch current (A)	ES Class
--	--	--	--	--	--	--
Supplementary information:						

IEC 62368-1			
Clause	Requirement + Test	Result - Remark	Verdict

6.2.2	TABLE: Power source circuit classifications						P
Location	Operating and fault condition	Voltage (V)	Current (A)	Max. Power ¹⁾ (W)	Time (S)	PS class	
Primary circuit	--	--	--	--	--	PS3(declared)	
Model: GTM96300-2307.5-2.5-R2							
DC output	max. test values are recorded. recorded)	4.8	5.4	33.9	5	PS2	
Model: GTM96300-3648-R2							
DC output	max. test values are recorded. recorded)	47.74	0.77	42.7	5	PS2	
Model: GTM96180-1807-2.0-T2							
DC output	max. test values are recorded. recorded)	4.77	3.90	24.6	5	PS2	
Model: GTM96180-1848-T2							
DC output	max. test values are recorded. recorded)	48.25	0.46	26.6	5	PS2	
Model: GTM91120-2007.5-2.5-T2							
DC output	max. test values are recorded. recorded)	4.8	4.5	21.6	5	PS2	
Model: GTM91120-3048-T2							
DC output	max. test values are recorded. recorded)	48	0.85	38.4	5	PS2	
Model: GTM91128LI3CEL							
DC output	max. test values are recorded. recorded)	12	2.0	31.2	5	PS2	
Model: GTM91128LI3CEL-12614							
DC output	max. test values are recorded. recorded)	12.8	1.41	21.9	5	PS2	
Model: GTM91128LI1CEL-T2-04220							
DC output	max. test values are recorded. recorded)	4.3	2.1	12.7	3	PS1	
Model: GTM91128LI3CELM-1261214010, GTM91128LI3CELM-1260214019							
DC output	max. test values are recorded. recorded)	14.2	2.0	32.2	5	PS2	
Model: GTM91128LI3CELM-1261214010, GTM91128LI3CELM-1260214019							
DC output	max. test values are recorded. recorded)	12.7	1.3	18.9	5	PS2	

IEC 62368-1			
Clause	Requirement + Test	Result - Remark	Verdict

Model: GTM91128LI1CELM-0421805024, GTM91128LI1CELM-0420405036						
DC output	max. test values are recorded. recorded)	5.12	3.7	24.3	5	PS2
Model: GTM91128LI1CELM-0421805024, GTM91128LI1CELM-0420405036						
DC output	max. test values are recorded. recorded)	4.3	1.9	11.9	5	PS1
Supplementary information:						
Abbreviation: SC= short circuit; OC= open circuit 1) Measured after 3 s for PS1 and measured after 5 s for PS2 and PS3. Note: The maximum power is measured under abnormal condition.						

6.2.3.1	TABLE: Determination of Arcing PIS				P
Location	Open circuit voltage after 3 s (Vpk)	Measured r.m.s current (A)	Calculated value	Arcing PIS? Yes / No	
*	*	*	*	Yes	
Supplementary information:					
An Arcing PIS requires a minimum of 50 V (peak) a.c. or d.c. An Arcing PIS is established when the product of the open circuit voltage (V_p) and normal operating condition rms current (I_{rms}) is greater than 15. (*) All components located within the power board are considered as arcing PIS.					

6.2.3.2	TABLE: Determination of resistive PIS			P
Location	Operating and fault condition	Dissipate power (W)	Arcing PIS? Yes / No	
*	*	*	Yes	
Supplementary information:				
Abbreviation: SC= short circuit; OC= open circuit A combination of voltmeter, VA and ammeter IA may be used instead of a wattmeter. If a separate voltmeter and ammeter are used, the product of (VA x IA) is used to determine Resistive PIS classification. A Resistive PIS: (a) dissipates more than 15 W, measured after 30 s of normal operation, <u>or</u> (b) under single fault conditions has either a power exceeding 100 W measured immediately after the introduction of the fault if electronic circuits, regulators or PTC devices are used, or has an available power exceeding 15 W measured 30 s after introduction of the fault. (*) All circuits are regarded as Resistive PIS.				

IEC 62368-1			
Clause	Requirement + Test	Result - Remark	Verdict

8.5.5	TABLE: High pressure lamp				N/A
Lamp manufacturer	Lamp type	Explosion method	Longest axis of glass particle (mm)	Particle found beyond 1 m Yes / No	
--	--	--	--	--	
Supplementary information:					

9.6	TABLE: Temperature measurements for wireless power transmitters								N/A
Supply voltage (V)..... :		--						—	
Max. transmit power of transmitter (W)..... :		--						—	
Foreign objects	w/o receiver and direct contact		with receiver and direct contact		with receiver and at distance of 2 mm		with receiver and at distance of 5 mm		
	Object (°C)	Ambient (°C)	Object (°C)	Ambient (°C)	Object (°C)	Ambient (°C)	Object (°C)	Ambient (°C)	
--	--	--	--	--	--	--	--	--	
Supplementary information:									

5.4.1.4, 9.3, B.1.5, B.2.6	TABLE: Temperature measurements					P
Supply voltage (V)..... :	90V, 60Hz	90V, 60Hz	264V, 60Hz	264V, 60Hz	—	
Ambient temperature during test T_{amb} (°C) :	40.0	24.8	40.0	24.9	—	
Maximum measured temperature T of part/at:	T (°C)				Allowed T_{max} (°C)	
Model: GTM96180-1807-2.0-T2						
T1 winding	105	--	99	--	110	
T1 core	102	--	94	--	Ref.	
Electrolytic capacitor C1	101	--	91	--	105	
Optocoupler U3	93	--	84	--	100	
Varistor MOV1	82	--	60	--	85	
Y-capacitor CY1	101	--	95	--	125	
X-capacitor CX1	85	--	63	--	100	
PCB near T1	111	--	105	--	130	

IEC 62368-1					
Clause	Requirement + Test	Result - Remark			Verdict
Plastic enclosure inside near transformer	90	--	88	--	95
Below temperatures are adjusted to ambient of 25 °C.					
Plastic enclosure outside near transformer	--	74	--	73	77
Model: GTM96180-1817.9-5.9-T2					
T1 winding	95	--	92	--	110
T1 core	93	--	92	--	Ref.
Electrolytic capacitor C1	99	--	79	--	105
Optocoupler U3	76	--	75	--	100
Varistor MOV1	77	--	59	--	85
Y-capacitor CY1	86	--	83	--	125
X-capacitor CX1	77	--	60	--	100
PCB near T1	94	--	80	--	130
Plastic enclosure inside near transformer	76	--	77	--	95
Below temperatures are adjusted to ambient of 25 °C.					
Plastic enclosure outside near transformer	--	52	--	53	77
Model: GTM96180-1838-2.0-T3A					
T1 winding	97	--	88	--	110
T1 core	95	--	88	--	Ref.
Electrolytic capacitor C1	96	--	73	--	105
Optocoupler U3	76	--	70	--	100
Varistor MOV1	74	--	55	--	85
Y-capacitor CY1	81	--	75	--	125
X-capacitor CX1	71	--	55	--	100
PCB near T1	93	--	74	--	130
Plastic enclosure inside near transformer	71	--	66	--	95
Below temperatures are adjusted to ambient of 25 °C.					
Plastic enclosure outside near transformer	--	53	--	47	77
Model: GTM96180-1848-T3					
T1 winding	92	--	86	--	110
T1 core	94	--	89	--	Ref.
Electrolytic capacitor C1	98	--	78	--	105
Optocoupler U3	73	--	69	--	100
Varistor MOV1	77	--	57	--	85

IEC 62368-1					
Clause	Requirement + Test	Result - Remark			Verdict
Y-capacitor CY1	90	--	84	--	125
X-capacitor CX1	77	--	58	--	100
PCB near T1	95	--	75	--	130
Plastic enclosure inside near transformer	75	--	71	--	95
Below temperatures are adjusted to ambient of 25 °C.					
Plastic enclosure outside near transformer	--	51	--	57	77
Model: GTM96300-2307.5-2.5-R2					
T1 winding	106	--	102	--	110
T1 core	98	--	93	--	Ref.
Electrolytic capacitor C1	95	--	84	--	105
Optocoupler U3	96	--	90	--	100
Varistor MOV1	66	--	55	--	85
Y-capacitor CY1	90	--	86	--	125
X-capacitor CX1	75	--	63	--	100
PCB near T1	88	--	84	--	130
Plastic enclosure inside near transformer	81	--	77	--	95
Below temperatures are adjusted to ambient of 25 °C.					
Plastic enclosure outside near transformer	--	58	--	55	77
Model: GTM96300-3617.9-5.9-R3A					
T1 winding	105	--	98	--	110
T1 core	105	--	98	--	Ref.
Electrolytic capacitor C1	102	--	81	--	105
Optocoupler U3	97	--	92	--	100
Varistor MOV1	72	--	56	--	85
Y-capacitor CY1	107	--	99	--	125
X-capacitor CX1	85	--	64	--	100
PCB near T1	96	--	88	--	130
Plastic enclosure inside near transformer	83	--	76	--	95
Below temperatures are adjusted to ambient of 25 °C.					
Plastic enclosure outside near transformer	--	58	--	53	77
Model: GTM96300-3624-R2					
T1 winding	105	--	88	--	110
T1 core	105	--	91	--	Ref.

IEC 62368-1					
Clause	Requirement + Test	Result - Remark			Verdict
Electrolytic capacitor C1	103	--	76	--	105
Optocoupler U3	92	--	87	--	100
Varistor MOV1	72	--	54	--	85
Y-capacitor CY1	98	--	87	--	125
X-capacitor CX1	89	--	62	--	100
PCB near T1	95	--	81	--	130
Plastic enclosure inside near transformer	84	--	74	--	95
Below temperatures are adjusted to ambient of 25 °C.					
Plastic enclosure outside near transformer	--	59	--	55	77
Model: GTM96300-3648-R3A					
T1 winding	103	--	90	--	110
T1 core	101	--	90	--	Ref.
Electrolytic capacitor C1	100	--	76	--	105
Optocoupler U3	98	--	90	--	100
Varistor MOV1	67	--	52	--	85
Y-capacitor CY1	95	--	86	--	125
X-capacitor CX1	79	--	58	--	100
PCB near T1	104	--	86	--	130
Plastic enclosure inside near transformer	88	--	81	--	95
Below temperatures are adjusted to ambient of 25 °C.					
Plastic enclosure outside near transformer	--	58	--	55	77
Model: GTM91128LI3CEL-12614					
T1 winding	105	--	107	--	110
T1 core	106	--	111	--	Ref.
Electrolytic capacitor C2	99	--	95	--	105
Optocoupler U3	101	--	102	--	110
Varistor MOV1	72	--	70	--	85
Y-capacitor CY1	84	--	86	--	125
X-capacitor CX1	80	--	78	--	100
PCB near T1	99	--	95	--	130
Output cord	70	--	65	--	80
Plastic enclosure inside near transformer	82	--	83	--	95
Below temperatures are adjusted to ambient of 25 °C.					

IEC 62368-1					
Clause	Requirement + Test	Result - Remark			Verdict
Plastic enclosure outside near transformer	--	51	--	52	77
Model: GTM91128LI1CEL-T2-04220					
T1 winding	104	--	109	--	110
T1 core	102	--	107	--	Ref
Electrolytic capacitor C2	84	--	86	--	105
Optocoupler U3	95	--	98	--	110
Varistor MOV1	66	--	67	--	85
Y-capacitor CY1	93	--	96	--	125
X-capacitor CX1	71	--	71	--	100
PCB near T1	87	--	88	--	130
Output cord	64	--	63	--	80
Plastic enclosure inside near transformer	82	--	83	--	95
Below temperatures are adjusted to ambient of 25 °C.					
Plastic enclosure outside near transformer	--	50	--	53	77
Model: GTM91128LI3CELM-1260214019					
T1 winding	109	--	104	--	110
T1 core	108	--	103	--	Ref
Electrolytic capacitor C2	104	--	96	--	105
Optocoupler U3	109	--	107	--	110
Varistor MOV1	74	--	62	--	85
Y-capacitor CY1	96	--	91	--	125
X-capacitor CX1	82	--	68	--	100
PCB near T1	121	--	107	--	130
Output cord	51	--	51	--	80
Plastic enclosure inside near transformer	84	--	88	--	95
Below temperatures are adjusted to ambient of 25 °C.					
Plastic enclosure outside near transformer	--	59	--	57	77
Model: GTM91128LI3CELM-1261214010					
T1 winding	106	--	105	--	110
T1 core	105	--	104	--	Ref
Electrolytic capacitor C2	101	--	96	--	105
Optocoupler U3	109	--	108	--	110
Varistor MOV1	72	--	63	--	85

IEC 62368-1					
Clause	Requirement + Test	Result - Remark			Verdict
Y-capacitor CY1	92	--	90	--	125
X-capacitor CX1	80	--	69	--	100
PCB near T1	116	--	107	--	130
Output cord	50	--	51	--	80
Plastic enclosure inside near transformer	81	--	80	--	95
Below temperatures are adjusted to ambient of 25 °C.					
Plastic enclosure outside near transformer	--	54	--	58	77
Model: GTM91128LI1CELM-0420405036					
T1 winding	87	--	87	--	110
T1 core	84	--	85	--	Ref
Electrolytic capacitor C2	84	--	78	--	105
Optocoupler U3	85	--	84	--	110
Varistor MOV1	59	--	56	--	85
Y-capacitor CY1	75	--	75	--	125
X-capacitor CX1	59	--	60	--	100
PCB near T1	84	--	72	--	130
Output cord	46	--	48	--	80
Plastic enclosure inside near transformer	74	--	73	--	95
Below temperatures are adjusted to ambient of 25 °C.					
Plastic enclosure outside near transformer	--	53	--	53	77
Model: GTM91128LI1CELM-0421805024					
T1 winding	98	--	99	--	110
T1 core	96	--	96	--	Ref
Electrolytic capacitor C2	91	--	84	--	105
Optocoupler U3	94	--	93	--	110
Varistor MOV1	62	--	59	--	85
Y-capacitor CY1	87	--	87	--	125
X-capacitor CX1	67	--	64	--	100
PCB near T1	91	--	77	--	130
Output cord	49	--	51	--	80
Plastic enclosure inside near transformer	82	--	81	--	95
Below temperatures are adjusted to ambient of 25 °C.					
Plastic enclosure outside near transformer	--	59	--	58	77

IEC 62368-1			
Clause	Requirement + Test	Result - Remark	Verdict

Ambient temperature during test T_{amb} (°C) :	75.0*	24.8	75.0*	24.9	—		
Maximum measured temperature T of part/at:	T (°C)				Allowed T_{max} (°C)		
Model: GTM96180-1830-12.0							
T1 winding	86	--	87	--	110		
T1 core	85	--	85	--	Ref		
Electrolytic capacitor C1	85	--	84	--	105		
Optocoupler U3	82	--	82	--	100		
Varistor MOV1	80	--	78	--	85		
Y-capacitor CY1	84	--	85	--	125		
X-capacitor CX1	82	--	81	--	100		
PCB near T1	87	--	87	--	130		
Plastic enclosure inside near transformer	80	--	81	--	95		
Below temperatures are adjusted to ambient of 25 °C.							
Plastic enclosure outside near transformer	--	26	--	27	77		
Temperature T of winding:	t_1 (°C)	R_1 (Ω)	t_2 (°C)	R_2 (Ω)	T (°C)	Allowed T_{max} (°C)	Insulation class
--	--	--	--	--	--	--	--
Supplementary information:							
* indicated thermocouple method was used to measure the winding, so the limit value reduced 10K. Note 1: Tma should be considered as directed by applicable requirement Note 2: Tma is not included in assessment of Touch Temperatures (Clause 9) Note 3: Test was repeated for three times as the temperature of T1 winding was close to limited value. *Derating load (output load 18Vdc, 0.3A) is considered because of derating under 75°C.							

B.2.5		TABLE: Input test							P
U (V)	Hz	I (A)	I rated (A)	P (W)	P rated (W)	Fuse No	I fuse (A)	Condition/status	
Model: GTM96180-1807-2.0-T2 & GTM96180-1807-2.0									
90	50/60	0.4062	--	22.64	--	F1/F2	0.4062	Max. normal load	
100	50/60	0.3675	0.6	22.27	--	F1/F2	0.3675		
240	50/60	0.1901	0.6	21.95	--	F1/F2	0.1901		
264	50/60	0.1758	--	22.18	--	F1/F2	0.1758		
Model: GTM96180-1817.9-5.9-T2 & GTM96180-1817.9-5.9									
90	50/60	0.3974	--	22.13	--	F1/F2	0.3974	Max. normal load	
100	50/60	0.3647	0.6	21.86	--	F1/F2	0.3647		

IEC 62368-1								
Clause	Requirement + Test					Result - Remark		Verdict
240	50/60	0.1859	0.6	21.35	--	F1/F2	0.1859	
264	50/60	0.1731	--	21.52	--	F1/F2	0.1731	
Model: GTM96180-1838-2.0-T2 & GTM96180-1838-2.0								
90	50/60	0.3851	--	21.35	--	F1/F2	0.3851	Max. normal load
100	50/60	0.3530	0.6	21.11	--	F1/F2	0.3530	
240	50/60	0.1806	0.6	20.55	--	F1/F2	0.1806	
264	50/60	0.1653	--	20.61	--	F1/F2	0.1653	
Model: GTM96180-1848-T2 & GTM96180-1848								
90	50/60	0.3794	--	20.94	--	F1/F2	0.3794	Max. normal load
100	50/60	0.3481	0.6	20.69	--	F1/F2	0.3481	
240	50/60	0.1774	0.6	20.26	--	F1/F2	0.1774	
264	50/60	0.1648	--	20.41	--	F1/F2	0.1648	
Model: GTM96300-2307.5-2.5-R3A								
90	50/60	0.5931	--	31.03	--	F1/F2	0.5931	Max. normal load
100	50/60	0.5285	1.0	30.53	--	F1/F2	0.5285	
240	50/60	0.2643	1.0	30.59	--	F1/F2	0.2643	
264	50/60	0.2332	--	30.71	--	F1/F2	0.2332	
Model: GTM96300-3614.5-2.5-R3A								
90	50/60	0.8171	--	43.36	--	F1/F2	0.8171	Max. normal load
100	50/60	0.7227	1.0	42.68	--	F1/F2	0.7227	
240	50/60	0.3547	1.0	42.07	--	F1/F2	0.3547	
264	50/60	0.3133	--	41.93	--	F1/F2	0.3133	
Model: GTM96300-3624-R3A								
90	50/60	0.8007	--	42.30	--	F1/F2	0.8007	Max. normal load
100	50/60	0.7162	1.0	41.84	--	F1/F2	0.7162	
240	50/60	0.3407	1.0	40.80	--	F1/F2	0.3407	
264	50/60	0.3109	--	40.86	--	F1/F2	0.3109	
Model: GTM96300-3648-R3A								
90	50/60	0.7682	--	41.46	--	F1/F2	0.7682	Max. normal load
100	50/60	0.6849	1.0	41.03	--	F1/F2	0.6849	
240	50/60	0.3343	1.0	39.91	--	F1/F2	0.3343	
264	50/60	0.3019	--	39.86	--	F1/F2	0.3019	
Model: GTM96300-3656-T3-APOE								

IEC 62368-1								
Clause	Requirement + Test				Result - Remark			Verdict
90	50/60	0.7245	--	40.92	--	F1/F2	0.7245	Max. normal load
100	50/60	0.6158	1.0	40.23	--	F1/F2	0.6158	
240	50/60	0.3205	1.0	39.37	--	F1/F2	0.3205	
264	50/60	0.2987	--	38.89	--	F1/F2	0.2987	
Model: GTM91120-2007.5-2.5-T2								
90	50/60	0.52	--	27.0	--	F1/F2	0.52	Max. normal load
100	50/60	0.47	1.0	26.2	--	F1/F2	0.47	
240	50/60	0.24	1.0	26.1	--	F1/F2	0.24	
264	50/60	0.22	--	26.1	--	F1/F2	0.22	
Model: GTM91120-3014.5-2.5-T2								
90	50/60	0.70	--	36.1	--	F1/F2	0.70	Max. normal load
100	50/60	0.64	1.0	35.7	--	F1/F2	0.64	
240	50/60	0.32	1.0	35.0	--	F1/F2	0.32	
264	50/60	0.29	--	35.1	--	F1/F2	0.29	
Model: GTM91120-3024-T3A								
90	50/60	0.65	--	35.0	--	F1/F2	0.65	Max. normal load
100	50/60	0.59	1.0	34.6	--	F1/F2	0.59	
240	50/60	0.30	1.0	33.8	--	F1/F2	0.30	
264	50/60	0.28	--	33.6	--	F1/F2	0.28	
Model: GTM91120-3048-T2								
90	50/60	0.66	--	35.2	--	F1/F2	0.66	Max. normal load
100	50/60	0.61	1.0	34.9	--	F1/F2	0.61	
240	50/60	0.30	1.0	33.6	--	F1/F2	0.30	
264	50/60	0.28	--	34.2	--	F1/F2	0.28	
Model: GTM91128LI3CEL-12614								
90	50/60	0.454	--	21.82	--	F1/F2	0.454	Max. normal load
100	50/60	0.422	1.0	21.71	--	F1/F2	0.422	
240	50/60	0.225	1.0	21.91	--	F1/F2	0.225	
264	50/60	0.209	--	21.89	--	F1/F2	0.209	
Model: GTM91128LI1CEL-T2-04220								
90	50/60	0.286	--	12.43	--	F1/F2	0.286	Max. normal load
100	50/60	0.264	1.0	12.45	--	F1/F2	0.264	
240	50/60	0.140	1.0	12.67	--	F1/F2	0.140	

IEC 62368-1								
Clause	Requirement + Test					Result - Remark		Verdict
264	50/60	0.131	--	12.76	--	F1/F2	0.131	
Model: GTM91128LI3CELM-1261214010(full load on Charger output)								
90	50/60	0.395	--	18.58	--	F1/F2	0.395	Max. normal load
100	50/60	0.366	1.0	18.50	--	F1/F2	0.366	
240	50/60	0.192	1.0	18.52	--	F1/F2	0.192	
264	50/60	0.181	--	18.75	--	F1/F2	0.181	
Model: GTM91128LI3CELM-1260214019(full load on power supply output)								
90	50/60	0.596	--	30.51	--	F1/F2	0.596	Max. normal load
100	50/60	0.553	1.0	30.27	--	F1/F2	0.553	
240	50/60	0.294	1.0	30.05	--	F1/F2	0.294	
264	50/60	0.274	--	30.12	--	F1/F2	0.274	
Model: GTM91128LI1CELM-0421805024(full load on Charger output)								
90	50/60	0.258	--	11.04	--	F1/F2	0.258	Max. normal load
100	50/60	0.237	1.0	11.01	--	F1/F2	0.237	
240	50/60	0.128	1.0	11.39	--	F1/F2	0.128	
264	50/60	0.122	--	11.54	--	F1/F2	0.122	
Model: GTM91128LI1CELM-0420405036(full load on power supply module output)								
90	50/60	0.474	--	22.61	--	F1/F2	0.474	Max. normal load
100	50/60	0.442	1.0	22.50	--	F1/F2	0.442	
240	50/60	0.230	1.0	22.41	--	F1/F2	0.230	
264	50/60	0.216	--	22.66	--	F1/F2	0.216	
Supplementary information:								
The maximum measured current under rated voltage did not exceed 110% of the rated current.								

B.3, B.4	TABLE: Abnormal operating and fault condition tests						P
Ambient temperature T_{amb} (°C).....	25.0, if not stated below.						—
Power source for EUT: Manufacturer, model/type, outputrating ..	Chroma, 61512, 18kVA						—
Component No.	Condition	Supply voltage (V)	Test time	Fuse no.	Fuse current (A)	Observation	
Output (5V series)	OL	264	1h	F1/F2	0.858A	Load to 5.44A, EUT protected immediately, no hazards. Temperature recorded: T1 winding = 94°C Enclosure: 58°C	

IEC 62368-1						
Clause	Requirement + Test			Result - Remark		Verdict
Output (48V series)	OL	264	1h	F1/F2	0.803A	Load to 0.768A, EUT protected immediately, no hazards. Temperature recorded: T1 winding = 109°C Enclosure: 66°C
Output	SC	90/264	10mins	F1/F2	0	EUT protected immediately, no hazards
C4	SC	90/264	10mins	F1/F2	0	EUT protected immediately, no hazards
Q1 pinD-S	SC	90/264	<1s	F1/F2	10*	EUT shut down immediately, fuse opened, repeat 10 times, no hazards
Q1 pinG-S	SC	90/264	10mins	F1/F2	0	EUT protected immediately, no hazards
D2	SC	90/264	10mins	F1/F2	0	EUT protected immediately, no hazards
T1 pin1-2	SC	90/264	<2mins	F1/F2	10*	EUT shut down, fuse opened, repeat 10 times, no hazards
T1 pinTA-TB	SC	90/264	10mins	F1/F2	0	EUT protected immediately, no hazards
C1	SC	90/264	<1s	F1/F2	10*	EUT shut down immediately, fuse opened, repeat 10 times, no hazards
BD1	SC	90/264	<1s	F1/F2	10*	EUT shut down immediately, fuse opened, repeat 10 times, no hazards
For model GTM91128LI3CELM-1261214010, GTM91128LI3CELM-1260214019						
Charger output	OL	264	1h	F1/F2	0.187	Load to 1.21A, EUT protected immediately, no hazards. Temperature recorded: T1 winding=105°C Enclosure=73°C
Charger output	OL	90	1h	F1/F2	0.405	Load to 1.21A, EUT protected immediately, no hazards. Temperature recorded: T1 winding=106°C Enclosure=69°C
Power supply output	OL	264	1h	F1/F2	0.281	Load to 2.01A, EUT protected immediately, no hazards. Temperature recorded: T1 winding=104°C Enclosure=72°C
Power supply output	OL	90	1h	F1/F2	0.605	Load to 2.01A, EUT protected immediately, no hazards. Temperature recorded: T1 winding=109°C Enclosure=76°C
Charger output	SC	90/264	10mins	F1/F2	0	EUT protected immediately, no hazards

IEC 62368-1						
Clause	Requirement + Test				Result - Remark	Verdict
Power supply output	SC	90/264	10mins	F1/F2	0	EUT protected immediately, no hazards
Q1 pin D-S	SC	90/264	40min	F1/F2	>10A	EUT shut down immediately, fuse opened, no hazards
Q1 pin G-S	SC	90/264	40min	F1/F2	>10A	EUT shut down immediately, fuse opened, no hazards
D4	SC	90/264	40min	F1/F2	>10A	EUT shut down immediately, fuse opened, no hazards
C2	SC	90/264	40min	F1/F2	>10A	EUT shut down immediately, fuse opened, no hazards
U2 pin 1-2	SC	90/264	45min	F1/F2	0	EUT protected immediately, no hazards
U2 pin 3-2	SC	90/264	45min	F1/F2	0	EUT protected immediately, no hazards
C12	SC	90/264	45min	F1/F2	0	EUT protected immediately, no hazards
D7	SC	90/264	45min	FS1/ FS2	>10	EUT shut down immediately, fuse opened, repeat 10 times, no hazards
For model GTM91128LI1CELM-0421805024, GTM91128LI1CELM-0420405036						
Charger output	OL	264	1h	F1/F2	0.142	Load to 1.81A, EUT protected immediately, no hazards. Temperature recorded: T1 winding=99°C Enclosure=77°C
Charger output	OL	90	1h	F1/F2	0.269	Load to 1.81A, EUT protected immediately, no hazards. Temperature recorded: T1 winding= 98°C Enclosure= 77°C
Power supply output	OL	264	1h	F1/F2	0.225	Load to 1.21A, EUT protected immediately, no hazards. Temperature recorded: T1 winding= 87°C Enclosure= 69°C
Power supply output	OL	90	1h	F1/F2	0.486	Load to 1.21A, EUT protected immediately, no hazards. Temperature recorded: T1 winding= 87°C Enclosure= 69°C
Charger output	SC	90/264	10mins	F1/F2	0	EUT protected immediately, no hazards
Power supply output	SC	90/264	10mins	F1/F2	0	EUT protected immediately, no hazards
Q1 pin D-S	SC	90/264	40min	F1/F2	>10A	EUT shut down immediately, fuse opened, no hazards
Q1 pin G-S	SC	90/264	40min	F1/F2	>10A	EUT shut down immediately, fuse opened, no hazards
D2	SC	90/264	40min	F1/F2	>10A	EUT shut down immediately, fuse opened, no hazards
C2	SC	90/264	40min	F1/F2	>10A	EUT shut down immediately,

IEC 62368-1						
Clause	Requirement + Test				Result - Remark	Verdict
						fuse opened, no hazards
U2 pin 1-2	SC	90/264	45min	F1/F2	0	EUT protected immediately, no hazards
U2 pin 3-2	SC	90/264	45min	F1/F2	0	EUT protected immediately, no hazards
C11	SC	90/264	45min	F1/F2	0	EUT protected immediately, no hazards
D7	SC	90/264	45min	F1/F2	0	EUT protected immediately, no hazards
For model GTM91128LI3CEL-12614						
Output	OL	264	1h	F1/F2	0.229	Load to 1.41 A, EUT protected immediately, no hazards. Temperature recorded: T1 winding= 109°C Enclosure= 82°C
Output	OL	90	1h	F1/F2	0.478	Load to 1.41 A, EUT protected immediately, no hazards. Temperature recorded: T1 winding= 105°C Enclosure= 81°C
Output	SC	90/264	10mins	F1/F2	0	EUT protected immediately, no hazards
Q1 pin D-S	SC	90/264	40min	F1/F2	>10A	EUT shut down immediately, fuse opened, no hazards
Q1 pin G-S	SC	90/264	40min	F1/F2	>10A	EUT shut down immediately, fuse opened, no hazards
D2	SC	90/264	40min	F1/F2	>10A	EUT shut down immediately, fuse opened, no hazards
C2	SC	90/264	40min	F1/F2	>10A	EUT shut down immediately, fuse opened, no hazards
U2 pin 1-2	SC	90/264	45min	F1/F2	0	EUT protected immediately, no hazards
U2 pin 3-2	SC	90/264	45min	F1/F2	0	EUT protected immediately, no hazards
C11	SC	90/264	45min	F1/F2	0	EUT protected immediately, no hazards
D7	SC	90/264	45min	F1/F2	0	EUT protected immediately, no hazards
For model GTM91128LI1CEL-T2-04220						
Output	OL	264	1h	F1/F2	0.147	Load to 2.10A, EUT protected immediately, no hazards. Temperature recorded: T1 winding= 109°C Enclosure= 83°C
Output	OL	90	1h	F1/F2	0.295	Load to 2.10A, EUT protected immediately, no hazards. Temperature recorded: T1 winding= 106°C Enclosure= 80°C
Output	SC	90/264	10mins	F1/F2	0	EUT protected immediately,

IEC 62368-1			
Clause	Requirement + Test	Result - Remark	Verdict

						no hazards
Q1 pin D-S	SC	90/264	40min	F1/F2	>10A	EUT shut down immediately, fuse opened, no hazards
Q1 pin G-S	SC	90/264	40min	F1/F2	>10A	EUT shut down immediately, fuse opened, no hazards
D2	SC	90/264	40min	F1/F2	>10A	EUT shut down immediately, fuse opened, no hazards
C2	SC	90/264	40min	F1/F2	>10A	EUT shut down immediately, fuse opened, no hazards
U2 pin 1-2	SC	90/264	45min	F1/F2	0	EUT protected immediately, no hazards
U2 pin 3-2	SC	90/264	45min	F1/F2	0	EUT protected immediately, no hazards
C11	SC	90/264	45min	F1/F2	0	EUT protected immediately, no hazards
D7	SC	90/264	45min	F1/F2	0	EUT protected immediately, no hazards

Supplementary information:

Abbreviation: S-C= short circuit; O/L = overload NL= no chemical leakage; NS= no spillage of liquid; NE= no explosion; NF= no emission of flame or expulsion of molten metal.

Test table is provided to record abnormal and fault conditions for all applicable energy sources including Thermal burn injury. Column "Abnormal/Fault." Specify if test condition by indicating "Abnormal" then the condition for a Clause B.3 test or "Single Fault" then the condition for Clause B.4.

1) The test result shown all safeguards remained effective and didn't lead to a single fault condition during abnormal operating condition; In addition all safeguards complied with applicable requirements in this standard after restoration of normal operating conditions.

2) The test result showed no Class 1 or 2 energy source become Class 3 level during and after single fault condition.

3) The overloaded condition is applied according to annex G.5.3.3. Winding Limit for T1: 175-10=165°C

M.3	TABLE: Protection circuits for batteries provided within the equipment					N/A
Is it possible to install the battery in a reverse polarity position?		--			—	
Equipment Specification	Charging					
	Voltage (V)			Current (A)		
	--			--		
Manufacturer/type	Battery specification					
	Non-rechargeable batteries		Rechargeable batteries			
	Discharging current (A)	Unintentional charging current (A)	Charging		Discharging current (A)	Reverse charging current (A)
			Voltage (V)	Current (A)		
	--	--	--	--	--	--

Note: The tests of M.3.2 are applicable only when above appropriate data is not available.

IEC 62368-1			
Clause	Requirement + Test	Result - Remark	Verdict

Specified battery temperature (°C)						--		
Component No.	Fault condition	Charge/discharge mode	Test time	Temp. (°C)	Current (A)	Voltage (V)	Observation	
--	--	--	--	--	--	--	--	
Supplementary information:								
Abbreviation: SC= short circuit; OC= open circuit NL= no chemical leakage; NS= no spillage of liquid; NE= no explosion; NF= no emission of flame or expulsion of molten metal.								

M.4.2	TABLE: Charging safeguards for equipment containing a secondary lithium battery						N/A
Maximum specified charging voltage (V)						--	---
Maximum specified charging current (A)						--	---
Highest specified charging temperature (°C)						--	
Lowest specified charging temperature (°C)						--	
Battery manufacturer/type	Operating and fault condition	Measurement			Observation		
		Charging voltage (V)	Charging current (A)	Temp. (°C)			
--	--	--	--	--	--		
Supplementary information:							
Abbreviation: SC= short circuit; OC= open circuit; MSCV= maximum specified charging voltage; MSCC= maximum specified charging current; HSCT= highest specified charging temperature; LSCT= lowest specified charging temperature							

Q.1	TABLE: Circuits intended for interconnection with building wiring (LPS)						P
Output Circuit	Condition	U _{oc} (V)	Time (s)	I _{sc} (A)		S (VA)	
				Meas.	Limit	Meas.	Limit
Model: GTM96300-2307.5-2.5-R2							
Output	Output OC	5.14	5	0	8	0	100
	Output O/L	5.14	5	5.44	8	33.9	100
	Single fault: Primary current limitation disabled. (R13 short)	5.14	5	0	8	0	100
Model: GTM96300-3648-R2							
Output	Output OC	48.09	5	0	8	0	100
	Output O/L	48.09	5	0.768	8	42.7	100
	Single fault: Primary current limitation disabled. (R13 short)	48.09	5	0	8	--	100

IEC 62368-1							
Clause	Requirement + Test	Result - Remark					Verdict
Model: GTM96180-1807-2.0-T2							
Output	Output OC	5.112	5	0	8	0	100
	Output O/L	5.112	5	3.9	8	24.6	100
	Single fault: Primary current limitation disabled. (R13 short)	5.112	5	0	8	0	100
Model: GTM96180-1848-T2							
Output	Output OC	48.44	5	0	8	0	100
	Output O/L	48.44	5	0.465	8	26.6	100
	Single fault: Primary current limitation disabled. (R13 short)	48.44	5	0	8	0	100
Model: GTM91120-2007.5-2.5-T2							
Output	Output OC	5.13	5	0	8	0	100
	Output O/L	5.13	5	4.5	8	21.6	100
	Single fault: Primary current limitation disabled. (R11 short)	5.13	5	0	8	0	100
Model: GTM91120-3048-T2							
Output	Output OC	48.03	5	0	8	0	100
	Output O/L	48.03	5	0.85	8	38.4	100
	Single fault: Primary current limitation disabled. (R11 short)	48.03	5	0	8	0	100
Model: GTM91128LI3CEL-12614							
Output	Output OC	12.36	5	0	8	0	100
	Output O/L	12.36	5	1.41	8	21.91	100
	Single fault: Primary current limitation disabled. (R13 short)	12.36	5	0	8	0	100
Model: GTM91128LI1CEL-T2-04220							
Output	Output OC	3.80	5	0	8	0	100
	Output O/L	3.80	5	2.10	8	12.76	100
	Single fault: Primary current limitation disabled. (R13 short)	3.80	5	0	8	0	100
Model: GTM91128LI3CELM-1261214010, GTM91128LI3CELM-1260214019							
Power supply output	Output OC	13.2	5	0	8	0	100
	Output O/L	13.2	5	2.01	8	31.54	100
	Single fault: Primary current limitation disabled. (R13 short)	13.2	5	0	8	0	100

IEC 62368-1							
Clause	Requirement + Test	Result - Remark					Verdict
Charger output	Output OC	12.3	5	0	8	0	100
	Output O/L	12.3	5	1.21	8	18.92	100
	Single fault: Primary current limitation disabled. (R13 short)	12.3	5	0	8	0	100
Model: GTM91128LI1CELM-0421805024, GTM91128LI1CELM-0420405036							
Power supply output	Output OC	4.57	5	0	8	0	100
	Output O/L	4.57	5	3.60	8	23.80	100
	Single fault: Primary current limitation disabled. (R13 short)	4.57	5	0	8	0	100
Charger output	Output OC	3.80	5	0	8	0	100
	Output O/L	3.80	5	1.81	8	11.97	100
	Single fault: Primary current limitation disabled. (R13 short)	3.80	5	0	8	0	100
Supplementary Information:							
Abbreviation: SC= short circuit; O/L = overload; OC=Open circuit							

T.2, T.3, T.4, T.5		TABLE: Steady force test					P
Location/Part	Material	Thickness (mm)	Probe	Force (N)	Test Duration (s)	Observation	
Internal components	--	--	Figure V.1	10	5	The clearance and creepage distances do not be reduced below the required values.	
External plastic enclosure	Plastic	2.0	Figure V.1	100	5	Enclosure remained intact, no crack/ opening developed. Internal ES3, TS3 were not accessible after test. No insulation breakdown.	
Supplementary information:							

T.6, T.9		TABLE: Impact test				N/A
Location/Part	Material	Thickness (mm)	Height (mm)	Observation		
--	--	--	--	--		
Supplementary information:						

IEC 62368-1			
Clause	Requirement + Test	Result - Remark	Verdict

T.7	TABLE: Drop test				P
Location/Part	Material	Thickness (mm)	Height (mm)	Observation	
External plastic enclosure	Plastic	2.0	1000	All safeguards remained effective.	
Supplementary information:					

T.8	TABLE: Stress relief test					P
Location/Part	Material	Thickness (mm)	Oven Temperature (°C)	Duration (h)	Observation	
External plastic enclosure	Plastic	2.0	70	7	All safeguards remained effective.	
Supplementary information:						

X	TABLE: Alternative method for determining minimum clearances distances				N/A
Clearance distanced between:	Peak of working voltage (V)	Required cl (mm)	Measured cl (mm)		
Supplementary information:					

IEC 62368-1			
Clause	Requirement + Test	Result - Remark	Verdict

4.1.2	TABLE: Critical components information					P
Object / part No.	Manufacturer/ trademark	Type / model	Technical data	Standard	Mark(s) of conformity ¹	
PCB	WALEX ELECTRONIC (WUXI) CO LTD	T2, T2A, T2B T4	V-0, 130°C, Min. thickness: 1.6mm	UL 796 IEC/EN 62368-1	UL E154355 and tested with appliance	
Alt.	DAFENG AREX ELECTRONICS TECHNOLOGY CO LTD	02V0, 03V0, 04V0	V-0, 130°C, Min. thickness: 1.6mm	UL 796 IEC/EN 62368-1	UL E186016 and tested with appliance	
Alt.	IANGXI ZHONG XIN HUA ELECTRONICS INDUSTRY CO LTD	ZXH-2	V-0, 130°C, Min. thickness: 1.6mm	UL 796 IEC/EN 62368-1	UL E331298 and tested with appliance	
Fuse (F1, F2) (F2 is optional)	Conquer Electronics Co., Ltd.	MST series	T1.6A, 250V, T3.15A, 250V	IEC/EN 60127-1, IEC/EN 60127-3, UL 248-1, UL 248-14	VDE 40017118 UL E82636	
Alt.	Suzhou Walter Electronic Co. Ltd.	2010	T1.6A, 250V, T3.15A, 250V	IEC/EN 60127-1, IEC/EN 60127-3, UL 248-1, UL 248-14	VDE 40018781 UL E56092	
Alt.	Suzhou Walter Electronic Co. Ltd.	ICP	T1.6A, 250V, T3.15A, 250V	IEC/EN 60127-1, IEC/EN 60127-3, UL 248-1, UL 248-14	VDE 40012824 UL E56092	
Alt.	Bel Fuse Ltd.	RST-Serie(s)	T1.6A, 250V, T3.15A, 250V	IEC/EN 60127-1, IEC/EN 60127-3, UL 248-1, UL 248-14	VDE 40011144 UL E20624	
Alt.	Cooper Bussmann LLC	SS-5	T1.6A, 250V, T3.15A, 250V	IEC/EN 60127-1, IEC/EN 60127-3, UL 248-1, UL 248-14	VDE 40015513 UL E19180	
Alt.	Shenzhen Lanson Electronics Co. Ltd.	SMT	T1.6A, 250V, T3.15A, 250V	IEC/EN 60127-1, IEC/EN 60127-3, UL 248-1, UL 248-14	VDE 40012592 UL E221465	
Alt.	Das & Sons International Ltd.	385T series	T1.6A, 250V, T3.15A, 250V	IEC/EN 60127-1, IEC/EN 60127-3, UL 248-1, UL 248-14	VDE 40008524 UL E205718	
Alt.	Dongguan Better Electronics Technology Co., Ltd.	932	T1.6A, 250V, T3.15A, 250V	IEC/EN 60127-1, IEC/EN 60127-3, UL 248-1, UL 248-14	VDE 40033369 UL E300003	
Alt.	Hollyland Company Limited	5ET	T1.6A, 250V, T3.15A, 250V	IEC/EN 60127-1, IEC/EN 60127-3, UL 248-1, UL 248-14	VDE 40015669 UL E156471	
Alt.	Conquer Electronics Co., Ltd.	MET series	T1.6A, 250V, T3.15A, 250V	IEC/EN 60127-1, IEC/EN 60127-3, UL 248-1, UL 248-14	VDE 40017157 UL E82636	

IEC 62368-1					
Clause	Requirement + Test			Result - Remark	Verdict
Alt.	Zhongshan Lanbao Electrical Appliances Co., Ltd.	RTI-10 Serie(s)	T1.6A, 250V, T3.15A, 250V	IEC/EN 60127-1, IEC/EN 60127-3, UL 248-1, UL 248-14	VDE 40017009 UL E213695
Bridging resistor (Optional) For model series GT*96180-***** use only	TY-Ohm Suzhou Electronic Works Co. Ltd	RT	10MΩ, 1W	IEC/EN 62368-1	UL E321764 and tested with appliance
Alt.	Yageo Components (Suzhou) Co. Ltd	HHV	10MΩ, 1W	IEC/EN 62368-1	VDE 40031974 UL E333286
Alt.	Yageo Corporation	RV series	10MΩ Max., 1W	IEC/EN 62368-1	UL CB Certif. No. DK-108482-UL and tested with appliance
Alt.	Ralec Electronic Corp	RTV series	10MΩ Max., 1W	IEC/EN 62368-1	UL CB Certif. No. DK-66106-M1-UL and tested with appliance
Alt.	Guangdong Fenghua Advanced Technology Holding Co.,Ltd.	RVS series	10MΩ Max., 1W	IEC/EN 62368-1	Nemko CB Certif. No. NO109708 and tested with appliance
Alt.	Viking Tech Corporation Kaoshiung Branch	HVRC series	10MΩ Max., 1W	IEC/EN 62368-1	UL CB (Cert. No.: DK-121748-UL)
Alt.	TZAI YUAN ENTERPRISE CO LTD	HSMD OR SMD	10MΩ Max., 1W	IEC/EN 62368-1	UL CB (Cert. No.: DK-29431-M1-UL)
Alt.	WALSIN TECHNOLOGY CORP	WF12N, WF20N, WF25N, WF08N, WF06N	10MΩ Max., 1W	IEC/EN 62368-1	UL CB Certif. No. DK-119162-UL and tested with appliance
Alt.	Yageo Corporation	AH series	10MΩ Max., 1W	IEC/EN 62368-1	UL CB Certif. No. DK-110207-UL and tested with appliance
Alt.	PDC	FVS03,FVS05 ,FVS06,FVS20,TF25V,TF06V,TF08V,TF12V,TF20V,FVS25	10MΩ Max., 1W	IEC/EN 62368-1	UL CB Certif. No. DK-101615-UL and tested with appliance
Y capacitor (CY1, CY2) (Optional)	TDK-EPC Corporation, Capacitors Group Circuit Devices Business Group	CD	Y1, AC250V, max 4700pF, 55/125/21/B	IEC/EN 60384-14 UL 60384-14 UL 1414	VDE 40029780 UL E37861

IEC 62368-1					
Clause	Requirement + Test			Result - Remark	Verdict
Alt.	Success Electronics Co., Ltd.	SE	Y1, AC250V, or AC500V, max 4700pF, 40/125/56/C	IEC/EN 60384-14 UL 60384-14 UL 1414	VDE 40037211 VDE 40020002 UL E114280
Alt.	Success Electronics Co., Ltd.	SB	Y1, AC250V, max 4700pF, 40/125/56/C	IEC/EN 60384-14 UL 60384-14 UL 1414	VDE 40037221 VDE 40020001 UL E114280
Alt.	Murata Mfg. Co., Ltd.	KX	Y1, AC250V, max 4700pF, 25/125/21/B	IEC/EN 60384-14 UL 60384-14 UL 1414	VDE 40002831 UL E37921
Alt.	Walsin Technology Corp.	AH	Y1, AC250V, max 4700pF, 25/125/21/C	IEC/EN 60384-14 UL 60384-14 UL 1414	VDE 40001804 UL E146544
Alt.	JYA-NAY Co., Ltd.	JN	Y1, AC250V, max 4700pF, 25/125/21/C	IEC/EN 60384-14 UL 60384-14 UL 1414	VDE 40001831 UL E201384
Alt.	Haohua Electronic Co.	CT 7	Y1, AC250V, max 4700pF, 30/125/56/C	IEC/EN 60384-14 UL 60384-14 UL 1414	VDE 40003902 UL E233106
Alt.	Jyh Chung Electronic Co., Ltd.	JD	Y1, AC250V, max 4700pF, 40/125/21/C	IEC/EN 60384-14 UL 60384-14 UL 1414	VDE 137027 UL E187963
Alt.	Jerro Electronics Corp.	JX-series	Y1, AC250V, max 4700pF, 55/125/21/C	IEC/EN 60384-14 UL 60384-14 UL 1414	VDE 40032158 UL E333001
X capacitor (CX1) (Optional)	Tenta Electric Industrial Co. Ltd.	MEX	Min. 250VAC, Max. 0.47µF, 40/100/21/B, X1 or X2	IEC/EN 60384-14 UL 60384-14 UL 1414	VDE 119119 UL E222911
Alt.	Joey Electronics (Dong Guan) Co., Ltd.	MPX	Min. 250VAC, Max. 0.47µF, 40/105/21/B, X1 or X2	IEC/EN 60384-14 UL 60384-14 UL 1414	VDE 40032481 UL E216807
Alt.	Cheng Tung Industrial Co., Ltd.	CTX	Min. 300VAC, Max. 0.47µF, 110 oC, X1 or X2	UL 60384-14 UL 1414	ENEC-02671-M1 UL E193049 and tested with appliance
Alt.	Joey Electronics (Dong Guan) Co., Ltd.	MPX	Min. 250VAC, Max. 0.47µF, 40/105/21/B, X1 or X2	IEC/EN 60384-14 UL 60384-14 UL 1414	VDE 40032481 UL E216807
Alt.	Ultra Tech Xiphi Enterprise Co. Ltd.	HQX	Min. 250VAC, Max. 0.47µF, 40/100/21/C, X1 or X2	IEC/EN 60384-14 UL 60384-14 UL 1414	VDE 40015608 UL E183780
Alt.	Yuon Yu Electronics Co. Ltd.	MPX	Min. 250VAC, Max. 0.47µF, 40/100/21/C, X1 or X2	IEC/EN 60384-14 UL 60384-14 UL 1414	VDE 40032392 UL E200119
Alt.	Sinhua Electronics (Huzhou) Co., Ltd.	MPX	Min. 250VAC, Max. 0.47µF, 40/100/21/C, X1 or X2	IEC/EN 60384-14 UL 60384-14 UL 1414	VDE 40014686 UL E237560

IEC 62368-1					
Clause	Requirement + Test			Result - Remark	Verdict
Alt.	Jiangsu Xinghua Huayu Electronics Co., Ltd.	MPX - Series	Min. 250VAC, Max. 0.47 μ F, 40/100/21/C, X1 or X2	IEC/EN 60384-14 UL 60384-14 UL 1414	VDE 40022417 UL E311166
Alt.	Dain Electronics Co., Ltd.	MEX, MPX, NPX	Min. 250VAC, Max. 0.47 μ F, 40/100/21/C, X1 or X2	IEC/EN 60384-14 UL 60384-14 UL 1414	VDE 40018798 UL E147776
Alt.	Shenzhen Jinghao Capacitor Co., Ltd.	CBB62B	Min. 250VAC, Max. 0.47 μ F, 40/110/56/B, X1 or X2	IEC/EN 60384-14 UL 60384-14 UL 1414	VDE 40018690 UL E252286
Photo coupler (U2/U3) (U2 for GTM91120, GTM91128LI* CEL**-**** and GTM91128***-**** series)	Everlight Electronics Co., Ltd.	EL817	Dti=0.5mm Int. , dcr=6.0mm EXT.dcr=7.7mm, thermal cycling test, 110°C	IEC/EN 60747-5-5	VDE 132249
Alt.	COSMO Electronics Corporation	K1010, KP1010	Dti=0.6mm Int. , dcr=4.0mm EXT.dcr=5.0mm, thermal cycling test, 115°C	IEC/EN 60747-5-5	VDE 132473
Alt.	Lite-On Technology Corporation	LTV-817	Dti=0.8mm Int. , EXT.dcr=7.8mm, thermal cycling test, 100°C	IEC/EN 60747-5-5	VDE 40015248
Alt.	Fairchild Semiconductor Pte Ltd.	H11A817B, FOD817B	Insulation voltage: 850V; Transient overvoltage: 6000V; CTI175; Int. Cr/ Ext. Cr: \geq 7,0/ 7,0 mm; 30/110/21	IEC/EN 60747-5-5	VDE 40026857
Alt.	Sharp Corporation Electronic Components and Devices Group	PC817	Insulation voltage: 890V; Transient overvoltage: 9000V Int. Cr/ Ext. Cr: 7.62/ 7.62 mm; 30/100/21	IEC/EN 60747-5-5	VDE 40008087
Alt.	Bright Led Electronics Corp.	BPC-817(A;B; C;D;L), BPC-817 M, BPC-817 S	Dti=0.4mm EXT.dcr=7.0mm, thermal cycling test, 100°C	IEC/EN 60747-5-5	VDE 40007240
Alt.	Toshiba Corporation Semiconductor & Storage Products Company	TLP817F	Dti > 0.4mm, Ext cr > 8.0mm, Isolation 3000Vac min., 110°C min., Thermal cycling test	IEC/EN 60747-5-5	VDE 40021173

IEC 62368-1					
Clause	Requirement + Test			Result - Remark	Verdict
Varistor (MOV/MOV 1, MOV for GTM91120, GTM91128LI* CEL **_**** and GTM91128*** -**** series) (Optional)	Thinking Electronic Industrial Co., Ltd.	TVR10471K, TVR14471K	300Vac, coating, Min. V-0, min. 85 °C, 6KV/3KA, pulse test passed	IEC 61051-1, IEC 61051-2, IEC 61051-2-2	VDE 005944
Alt.	Centra Science Corp.	10D471K, 14D471K	300Vac, coating, Min. V-0, min. 85 °C, 6KV/3KA, pulse test passed	IEC 61051-1, IEC 61051-2, IEC 61051-2-2	VDE 4008220
Alt.	Success Electronics Co., Ltd.	SVR10D471K SVR14D471K	300Vac, coating, Min. V-0, min. 85 °C, 6KV/3KA, pulse test passed	IEC 61051-1, IEC 61051-2, IEC 61051-2-2	VDE 40030401
Alt.	Walsin Technology Co., Ltd.	14D471K 10D471K	300Vac, coating, Min. V-0, min. 85 °C, 6KV/3KA, pulse test passed	IEC 61051-1, IEC 61051-2, IEC 61051-2-2	VDE 40010090
Alt.	Lien Shun Electronics Co., Ltd.	14D471K 10D471K	300Vac, coating, Min. V-0, min. 85 °C, 6KV/3KA, pulse test passed	IEC 61051-1, IEC 61051-2, IEC 61051-2-2	VDE 40005858
Alt.	Ceramate Techn. Co., Ltd.	GNR10D471K GNR14D471K	300Vac, coating, Min. V-0, min. 85 °C, 6KV/3KA, pulse test passed	IEC 61051-1, IEC 61051-2, IEC 61051-2-2	VDE 40031745
Alt.	Brightking (Shenzhen) Co., Ltd.	14D471K 10D471K	300Vac, coating, Min. V-0, min. 85 °C, 6KV/3KA, pulse test passed	IEC 61051-1, IEC 61051-2, IEC 61051-2-2	VDE 40027827
Alt.	Joyin Co., Ltd.	JVR10N471K JVR14N471K	300Vac, coating, Min. V-0, min. 85 °C, 6KV/3KA, pulse test passed	IEC 61051-1, IEC 61051-2, IEC 61051-2-2	VDE 005937
Alt.	Thinking Electronic Industrial Co., Ltd.	TVR10621	385Vac, coating, Min. V-0, min. 105 °C, 6KV/3KA, pulse test passed	IEC 61051-1, IEC 61051-2, IEC 61051-2-2	VDE 005944
Alt.	Shantou High-New Technology Dev. Zone Songtian Enterprise Co., Ltd.	10D621K	385Vac, coating, Min. V-0, min. 125 °C, 6KV/3KA, pulse test passed	IEC 61051-1, IEC 61051-2, IEC 61051-2-2	VDE 40023049
Alt.	Xiamen Set Electronics Co., Ltd.	TFV8S471K	300Vac, coating, Min. V-0, min. 105 °C, 6KV/3KA, pulse test passed	IEC 61051-1, IEC 61051-2, IEC 61051-2-2	TUV RH J50554061
Alt.	Xiamen Set Electronics Co., Ltd.	TFV10S471K	300Vac, coating, Min. V-0, min. 105 °C, 6KV/3KA, pulse test passed	IEC 61051-1, IEC 61051-2, IEC 61051-2-2	TUV RH J50554091

IEC 62368-1					
Clause	Requirement + Test			Result - Remark	Verdict
Appliance inlet CON1 Class I units (C6 type)	LECI Electronics Co., Ltd	DB-6	2.5A, 250Vac	IEC/EN 60320-1	VDE 40032465
Alt.	Rich Bay Co., Ltd.	R-30790	2.5A, 250Vac	IEC/EN 60320-1	VDE 40030381
Alt.	Sun Fair Electric Wire & Cable (HK) Co. Ltd.	S-02	2.5A, 250Vac	IEC/EN 60320-1	VDE 40034448
Alt.	Rong Feng Industrial Co., Ltd.	RF-190	2.5A, 250Vac	IEC/EN 60320-1	VDE 40030379
Alt.	Inalways Corporation	0724	2.5A, 250Vac	IEC/EN 60320-1	ENEC 2010080
Alt.	Zhe Jiang Bei Er jia	ST-A04-002	2.5A, 250Vac	IEC/EN 60320-1	VDE 40016045
Appliance inlet CON1 Class I units (C14 type)	LECI Electronics Co., Ltd	DB-14	10A, 250Vac	IEC/EN 60320-1	VDE 40032137
Alt.	Rich Bay Co., Ltd.	R-301SN	10A, 250Vac	IEC/EN 60320-1	VDE 40030228
Alt.	Sun Fair Electric Wire & Cable (HK)Co. Ltd.	S-03	10A, 250Vac	IEC/EN 60320-1	VDE 40034447
Alt.	TECX-UNIONS Technology Corporation	TU-301-S, TU-301-SP	10A, 250Vac	IEC/EN 60320-1	ENEC-01898-M1 UL E220004
Alt.	Rong Feng Industrial Co., Ltd.	SS-120	10A, 250Vac	IEC/EN 60320-1	VDE 40028101
Alt.	Zhe Jiang Bei Er jia	ST-A01-003J	10A, 250Vac	IEC/EN 60320-1	VDE 40013388
Alt.	Inalways Corporation	0711	10A, 250Vac	IEC/EN 60320-1	ENEC 2010084
Appliance inlet CON1 Class II units (C8 type)	LECI Electronics Co., Ltd	DB-8	2.5A, 250Vac	IEC/EN 60320-1	VDE 40032028
Alt.	Rich Bay Co., Ltd.	R-201SN90	2.5A, 250Vac	IEC/EN 60320-1	VDE 40030384
Alt.	Sun Fair Electric Wire & Cable (HK)Co. Ltd.	S-01	2.5A, 250Vac	IEC/EN 60320-1	VDE 40034449
Alt.	Rong Feng Industrial Co., Ltd.	RF-180	2.5A, 250Vac	IEC/EN 60320-1	VDE 40030168
Alt.	Inalways Corporation	0721	2.5A, 250Vac	IEC/EN 60320-1	ENEC 2010087
Alt.	Zhe Jiang Bei Er jia	ST-A03-005	2.5A, 250Vac	IEC/EN 60320-1	VDE 40014833
Alt.	Kunshan DLK Electronics Technology Co., Ltd	CDJ-8	2.5A, 250Vac	IEC/EN 60320-1	VDE 40025531

IEC 62368-1					
Clause	Requirement + Test			Result - Remark	Verdict
Appliance inlet CN1 Class II units (C18 type)	HCR ELECTRONICS CO., LTD	SK05	10A, 250Vac	IEC/EN 60320-1	ENEC NO4018
Alt.	Rong Feng Industrial Co., Ltd.	SS-120	10A, 250Vac	IEC/EN 60320-1	VDE 40028101
Earthing wire for Class I model	ZHUANG SHAN CHUAN ELECTRICAL PRODUCTS (KUNSHAN) CO LTD	1015,1007, 1185	Min. 20 AWG, Min. 300V, Min. 80°C	UL 758 IEC/EN 62368-1	UL E333601 and tested with appliance
Alt.	DONGGUAN CHUANTAI WIRE PRODUCTS CO LTD	1015,1007, 1185	Min. 20 AWG, Min. 300V, Min. 80°C	UL 758 IEC/EN 62368-1	UL E315628 and tested with appliance
Alt.	YONG HAO ELECTRICAL INDUSTRY CO LTD	1015,1007, 1185	Min. 20 AWG, Min. 300V, Min. 80°C	UL 758 IEC/EN 62368-1	UL E240426 and tested with appliance
Alt.	Dongguan Cooperation Wire&Cable Co Ltd	1015,1007, 1185	Min. 20 AWG, Min. 300V, Min. 80°C	UL 758 IEC/EN 62368-1	UL E204204 and tested with appliance
Alt.	KUNSHAN XINGHONGMEN G ELECTRONIC CO LTD	1015,1007, 1185	Min. 20 AWG, Min. 300V, Min. 80°C	UL 758 IEC/EN 62368-1	UL E315421 and tested with appliance
Alt.	Suzhou Jiahuishu Electronic Co Ltd	1015, 1007, 1185	Min. 20 AWG, Min. 300V, Min. 80°C	UL 758 IEC/EN 62368-1	UL E353532 and tested with appliance
Output cord	KUNSHAN NEW ZHICHENG ELECTRONICS TECHNOLOGIES CO LTD	1185, 2464, 2468, 1015	Min. 20AWG, min. 300Vac, min. 80°C	UL 758 IEC/EN 62368-1	UL E237831 and tested with appliance
Alt.	Interchangeable	Interchangeable	Min. 20AWG, min. 300Vac, min. 80°C	UL 758 IEC/EN 62368-1	S, ETL, UL or other EU certification marks
Heat-shrinkable tubing (Optional)	SHENZHEN WOER HEAT-SHRINKABLE MATERIAL CO LTD	RSFR, RSFR-H, RSFR-HPF	600V, 125°C	UL 510A IEC/EN 62368-1	UL E203950 and tested with appliance
Alt.	QIFURUI ELECTRONICS CO	QFR-h	600V, 125°C	UL 510A IEC/EN 62368-1	UL E225897 and tested with appliance
Alt.	DONGGUAN SALIPT CO LTD	SALIPT S-901-300, SALIPT S-901-600	Min. 300V, 125°C	UL 510A IEC/EN 62368-1	UL E209436 and tested with appliance
Alt.	GUANGZHOU KAIHENG ENTERPRISE GROUP	K-2 (+) K-2 (CB)	Min. 300V, 125°C	UL 510A IEC/EN 62368-1	UL E214175 and tested with appliance

IEC 62368-1					
Clause	Requirement + Test			Result - Remark	Verdict
Alt.	CHANGYUAN ELECTRONICS (SHENZHEN) CO LTD	CB-HFT	Min. 300V, 125°C	UL 510A IEC/EN 62368-1	UL E180908 and tested with appliance
Thermal conductive pad	Suzhou Springgrass Electronic Technology Co., LTD	H RTP-M16	V-0, 130°C, Min. thickness: 5.8mm	UL 94 IEC/EN 62368-1	UL E528141 and tested with appliance
Alt.	SUZHOU HUI MEI PACKAGING PRODUCTS CO LTD	HM-300	V-0, 130°C, Min. thickness: 5.8mm	UL 94 IEC/EN 62368-1	UL E516470 and tested with appliance
Line filter LF1 (for GT*96300 >*91120 & GTM91128 series)	GlobTek/HAOPU WEI/HEJIA/BOAM /ENG	LF007	17mH	IEC/EN 62368-1	Tested with appliance
Line filter LF1 (for GT*96180 series)	GlobTek/HAOPU WEI/HEJIA/BOAM /ENG	NF00001D	32mH	IEC/EN 62368-1	Tested with appliance
Transformer (T1)	GlobTek / BOAM / HAOPUWEI	See attachment for details	Class B	IEC/EN 62368-1	Tested with appliance
-Magnet wire (primary)	PACIFIC ELECTRIC WIRE & CABLE (SHENZHEN) CO LTD	UEWN/U	MW28-C, 130°C	UL 1446 IEC/EN 62368-1	UL E201757 and tested with appliance
Alt.	PACIFIC ELECTRIC WIRE & CABLE (SHENZHEN) CO LTD	UEWS/U	MW75-C, 130°C	UL 1446 IEC/EN 62368-1	UL E201757 and tested with appliance
Alt.	JUNG SHING WIRE CO LTD	UEW-4	MW75C, 130°C	UL 1446 IEC/EN 62368-1	UL E174837 and tested with appliance
Alt.	JUNG SHING WIRE CO LTD	UEY-2	MW28-C, 130°C	UL 1446 IEC/EN 62368-1	UL E174837 and tested with appliance
Alt.	JIANGSU HONGLIU MAGNET WIRE TECHNOLOGY CO LTD	2UEW/130	MW75-C, 130°C	UL 1446 IEC/EN 62368-1	UL E335065 and tested with appliance
Alt.	WUXI JUFENG COMPOUND LINE CO LTD	2UEWB	MW75#, 130°C	UL 1446 IEC/EN 62368-1	UL E206882 and tested with appliance
Alt.	JIANGSU DARTONG M & E CO LTD	UEW	MW 75-C, 130°C	UL 1446 IEC/EN 62368-1	UL E237377 and tested with appliance
Alt.	SHANDONG SAINT ELECTRIC CO LTD	UEW/130	MW75#, 130°C	UL 1446 IEC/EN 62368-1	UL E194410 and tested with appliance

IEC 62368-1					
Clause	Requirement + Test			Result - Remark	Verdict
Alt.	ZHEJIANG LANGLI ELECTRIC EQUIPMENTS CO LTD	UEW	MW 79#, 130oC	UL 1446 IEC/EN 62368-1	UL E222214 and tested with appliance
Alt.	NINGBO JINTIAN NEW MATERIAL CO LTD	2UEW/130	MW 75-C, 130oC	UL 1446 IEC/EN 62368-1	UL E227047 and tested with appliance
-Triple- insulated wire (Secondary)	Great Leoflon Industrial Co., Ltd.	TRW (B) Serie(s)	Class B, 130°C, reinforced insulation	UL 2353 IEC/EN 62368-1	VDE 136581 UL E211989
Alt.	KBI COSMOLINK CO.,LTD.	TIW-M Serie(s)	Class B, 130°C, reinforced insulation	UL 2353 IEC/EN 62368-1	VDE 138053 UL E213764
Alt.	Furukawa Electric Co., Ltd.	TEX-E	Class B, 130°C, reinforced insulation	UL 2353 IEC/EN 62368-1	VDE 006735 UL E206440
Alt.	TOTOKU ELECTRIC CO LTD	TIW-2	Class B, 130°C, reinforced insulation	UL 2353 IEC/EN 62368-1	VDE 40044910 UL E249037
Alt.	E&B TECHNOLOGY CO LTD	E&B-XXXB, E&B-XXXB-1	Class B, 130°C, reinforced insulation	UL 2353 IEC/EN 62368-1	VDE 40023473 UL E315265
Alt.	SHENZHEN JIUDING NEW MATERIAL CO LTD	DTIW-B	Class B, 130oC, reinforced insulation	UL 2353 IEC/EN 62368-1	VDE 40037495 UL E357999
-Bobbin	CHANG CHUN PLASTICS CO LTD	T375J, T375HF	V-0, 150°C, thickness 0.45 mm min.	UL 94 IEC/EN 62368-1	UL E59481 and tested with appliance
Alt.	CHANG CHUN PLASTICS CO LTD	4130	V-0, 140°C, thickness 0.74 mm min.	UL 94 IEC/EN 62368-1	UL E59481 and tested with appliance
Alt.	SUMITOMO BAKELITE CO LTD	PM-9820, PM- 9630, PM- 9823	V-0, 150°C, thickness 0.45 mm min.	UL 94 IEC/EN 62368-1	UL E41429 and tested with appliance
Alt.	Resonac Techno Service Corporation	CP-J-8800	V-0, 150°C, thickness 0.45 mm min.	UL 94 IEC/EN 62368-1	UL E514814 and tested with appliance
-Insulating tape	3M COMPANY ELECTRICAL MARKETS DIV (EMD)	1350F-1, 1350T-1, 44	Min.130°C	UL 510A IEC/EN 62368-1	UL E17385 and tested with appliance
Alt.	BONDTEC PACIFIC CO LTD	370S	Min.130°C	UL 510A IEC/EN 62368-1	UL E175868 and tested with appliance
Alt.	JINGJIANG YAHUA PRESSURE SENSITIVE GLUE CO LTD	PZ, CT, WF	Min.130°C	UL 510A IEC/EN 62368-1	UL E165111 and tested with appliance
Alt.	HUIZHOU YAHUA ELECTRONIC TECHNOLOGY CO LTD	CT	Min.130°C	UL 510A IEC/EN 62368-1	UL E495875 and tested with appliance

IEC 62368-1					
Clause	Requirement + Test			Result - Remark	Verdict
Alt.	JINGJIANG JINGYI ADHESIVE PRODUCT CO LTD	JY25-A	Min.130°C	UL 510A IEC/EN 62368-1	UL E246950 and tested with appliance
Alt.	CHANG SHU LIANG YI TAPE INDUSTRY CO LTD	LY-XX	Min.130°C	UL 510A IEC/EN 62368-1	UL E246820 and tested with appliance
-PTFE tubing	Great Holding Industrial Co Ltd	TFT, TFS	Min. 300V, 200°C	UL 224 IEC/EN 62368-1	UL E156256 and tested with appliance
Alt.	Shenzhen Woer Heat-Shrinkable Material Co Ltd	WF	600V, 200°C	UL 224 IEC/EN 62368-1	UL E203950 and tested with appliance
Alt.	Changyuan Electronics (Shenzhen) Co Ltd	CB-TT-T, CB- TT-S	Min. 300V, 200°C	UL 224 IEC/EN 62368-1	UL E180908 and tested with appliance
Enclosure (all parts)	SABIC INNOVATIVE PLASTICS B V	HF500R	V-0, 125°C, Min. thickness: 2.0mm	UL 94 IEC/EN 62368 1	UL E45329 and tested with appliance
Alt.	SABIC INNOVATIVE PLASTICS B V	CX7211	V-0, 90°C, Min. thickness: 2.0mm	UL 94 IEC/EN 62368 1	UL E45329 and tested with appliance
Alt.	SABIC INNOVATIVE PLASTICS B V	945	V-0, 120°C, Min. thickness: 2.0mm	UL 94 IEC/EN 62368 1	UL E45329 and tested with appliance
Alt.	SABIC JAPAN L L C	C2950	V-0, 105°C, Min. thickness: 2.0mm	UL 94 IEC/EN 62368 1	UL E207780 and tested with appliance
Alt.	SABIC JAPAN L L C	CX7211	V-0, 90°C, Min. thickness: 2.0mm	UL 94 IEC/EN 62368 1	UL E207780 and tested with appliance
Alt.	SABIC JAPAN L L C	945	V-0, 120°C, Min. thickness: 2.0mm	UL 94 IEC/EN 62368 1	UL E207780 and tested with appliance
Alt.	TEIJIN CHEMICALS LTD	LN-1250G	V-0, 115°C, Min. thickness: 2.0mm	UL 94 IEC/EN 62368 1	UL E50075 and tested with appliance
Alt.	SABIC INNOVATIVE PLASTICS B V	SE1X, SE1	V-0, 105°C, Min. thickness: 2.0mm	UL 94 IEC/EN 62368 1	UL E45329 and tested with appliance
Alt.	SABIC INNOVATIVE PLASTICS B V	SE100	V-0, 95°C, Min. thickness: 2.0mm	UL 94 IEC/EN 62368 1	UL E45329 and tested with appliance
Alt.	SABIC JAPAN L L C	SE1X, SE1	V-0, 105°C, Min. thickness: 2.0mm	UL 94 IEC/EN 62368 1	UL E207780 and tested with appliance
Alt.	SABIC JAPAN L L C	SE100	V-0, 95°C, Min. thickness: 2.0mm	UL 94 IEC/EN 62368 1	UL E207780 and tested with appliance
Alt.	SABIC JAPAN L L C	HF500R	V-0, 125°C, Min. thickness: 2.0mm	UL 94 IEC/EN 62368 1	UL E207780 and tested with appliance
Alt.	SABIC INNOVATIVE PLASTICS US L L C	945	V-0, 120°C, Min. thickness: 2.0mm	UL 94 IEC/EN 62368 1	UL E121562 and tested with appliance

IEC 62368-1					
Clause	Requirement + Test			Result - Remark	Verdict
Mylar sheet (Optional)	SUMITOMO BAKELITE CO LTD	AV-Lite DP 901	Diallyl Phthalate (DAP), V-0, thickness min.: 0.4mm. min.105°C,	UL 94 IEC/EN 62368 1	UL E41429 and tested with appliance
Alt.	SABIC INNOVATIVE PLASTICS US L L C	FR700	PC, V-0, thickness: min. 0.4mm; min.105°C	UL 94 IEC/EN 62368 1	UL E121562 and tested with appliance
Alt.	DUPONT HONGJI FILMS FOSHAN CO LTD	EM, MO31	PET, VTM-2, thickness: min. 0.4mm; min.105°C	UL 94 IEC/EN 62368 1	UL E241830 and tested with appliance
Alt.	Kanglongxin	PC-811A, PC-813A	PC, VTM-2, thickness: min. 0.4mm; min.80°C	UL 94 IEC/EN 62368 1	UL E315185 and tested with appliance
Alt.	MIANYANG LONGHUA FILM CO LTD	PC-770, PC-770A, PC-870A, PC-1870A, PP-BK18	PC, VTM-0, thickness: min. 0.4mm; min.80°C	UL 94 IEC/EN 62368 1	UL E254551 and tested with appliance
Alt.	TORAY INDUSTRIES INC	Lumirror H10	PC, VTM-2, thickness: min. 0.4mm; min.105°C	UL 94 IEC/EN 62368 1	UL E86511 and tested with appliance
Alt.	SKC CO LTD	SH71S	PC, VTM-2, thickness: min. 0.4mm; min.105°C	UL 94 IEC/EN 62368 1	UL E74359 and tested with appliance
Alt.	FORMEX, DIV OF IL TOOL WORKS INC, FRMRLY FASTEX, DIV OF ILTOOL WORKS INC	FORMEX GK series	PC, V-0, thickness: min. 0.4mm; min.105°C	UL 94 IEC/EN 62368 1	UL E121855 and tested with appliance
Alt.	SABIC INNOVATIVE PLASTICS US LLC	FR60 series, FR63 series, FR65 series, FR7 series, FR700 series	PC, V-0, thickness: min. 0.4mm; min.130°C	UL 94 IEC/EN 62368 1	UL E121562 and tested with appliance
Alt.	MIANYANG LONGHUA FILM CO LTD	PP-BK-20, PP-BK-17, PP-BK-18	PC, VTM-0, thickness: min. 0.4mm; min.80°C	UL 94 IEC/EN 62368 1	UL E254551 and tested with appliance
Alt.	CHENGDU KANGLONGXIN PLASTICS CO LTD	KLX PP, WT-10 series	PC, VTM-0, thickness: min. 0.4mm; min.110°C	UL 94 IEC/EN 62368 1	UL E315185 and tested with appliance
Alt.	CHENGDU KANGLONGXIN PLASTICS CO LTD	KLX FRPC-1860B	PC, VTM-0, thickness: min. 0.4mm; min.80°C	UL 94 IEC/EN 62368 1	UL E315185 and tested with appliance
Alt.	JiangSu YuXing	CY28	PET, VTM-2, thickness: min. 0.4mm; min.105°C	UL 94 IEC/EN 62368 1	UL E212271 and tested with appliance
Supplementary information: 1) Provided evidence ensures the agreed level of compliance. See OD-CB2039.					

IEC 62368-1			
Clause	Requirement + Test	Result - Remark	Verdict

Attachment for transformer as below:

Product Model	Voltage Range	Transformer model	Product Model	Voltage Range	Transformer model
GTM96180	5V-8V	TF042	GTM96300	5-8.9V	TF038
	8.1V-14.9V	TF043		9-11.9V	TF057
	15V-18.9V	TF044		12-14.9V	TF039
	19V-30V	TF045		15-24V	TF040
	30.1V-48V	TF046		24.1-48V	TF041
GTM96180 POE	18V	TF064	GTM96300 POE	18V	TF068
	24V	TF065		24V	TF069
	36V	TF066		36V	TF070
	48V	TF067		48V	TF051
	54V, 56V	TF063		54V, 56V	TF051
GTM91120 series	5-7.5V	GT-3005001	GTM91128LI*CEL** ****, GTM91128***-**** series;	5.0-7.5V for power supply output, 3.2V- 5.9V for charger output	GT-3005001
		GT-3009001		7.6-12V for power supply output, 6.0V- 8.9V for charger output	GT-3012001
	10.6V-14.5V	GT-3012001	GTM91128LI1CEL GTM91128LI2CEL GTM91128LI3CEL	12.1-14V for power supply output, 9.0V- 12.6V for charger output	GT-3015001
	14.6V-19.5V	GT-3015001			
	19.6V-24V	GT-3024001			
	24.1V-48V	GT-3048001			

IEC 62368-1			
Clause	Requirement + Test	Result - Remark	Verdict

ATTACHMENT TO TEST REPORT IEC 62368-1 EUROPEAN GROUP DIFFERENCES AND NATIONAL DIFFERENCES (AUDIO/VIDEO, INFORMATION AND COMMUNICATION TECHNOLOGY EQUIPMENT - PART 1: SAFETY REQUIREMENTS)			
Differences according to: EN IEC 62368-1:2020+A11:2020			
Attachment Form No.: EU_GD_IEC62368_1E			
Attachment Originator: UL(Demko)			
Master Attachment: 2021-02-04			
Copyright © 2021 IEC System for Conformity Testing and Certification of Electrical Equipment (IECEE), Geneva, Switzerland. All rights reserved.			
CENELEC COMMON MODIFICATIONS (EN)			
	Clause numbers in the cells that are shaded light grey are clause references in EN IEC 62368-1:2020+A11:2020. All other clause numbers in that column, except for those in the paragraph below, refers to IEC 62368-1:2018. Clauses, subclauses, notes, tables, figures and annexes which are additional to those in IEC 62368-1:2018 are prefixed "Z".		P
	Add the following annexes: Annex ZA (normative) Normative references to international publications with their corresponding European publications Annex ZB (normative) Special national conditions Annex ZC (informative) A-deviations Annex ZD (informative) IEC and CENELEC code designations for flexible cords		P
1	Modification to Clause 3 .		
3.3.19	Sound exposure <i>Replace 3.3.19 of IEC 62368-1 with the following definitions:</i>		N/A

IEC 62368-1			
Clause	Requirement + Test	Result - Remark	Verdict
3.3.19.1	<p>momentary exposure level, MEL</p> <p>metric for estimating 1 s sound exposure level from the HD 483-1 S2 test signal applied to both channels, based on EN 50332-1:2013, 4.2.</p> <p>Note 1 to entry: MEL is measured as A-weighted levels in dB.</p> <p>Note 2 to entry: See B.3 of EN 50332-3:2017 for additional information.</p>	Considered.	N/A
3.3.19.3	<p>sound exposure, E</p> <p>A-weighted sound pressure (p) squared and integrated over a stated period of time, T</p> <p>Note 1 to entry: The SI unit is Pa² s.</p> $E = \int_0^T p(t)^2 dt$		N/A
3.3.19.4	<p>sound exposure level, SEL</p> <p>logarithmic measure of sound exposure relative to a reference value, E_0, typically the 1 kHz threshold of hearing in humans.</p> <p>Note 1 to entry: SEL is measured as A-weighted levels in dB.</p> $SEL = 10 \lg \left(\frac{E}{E_0} \right) \text{ dB}$ <p>Note 2 to entry: See B.4 of EN 50332-3:2017 for additional information.</p>		N/A
3.3.19.5	<p>digital signal level relative to full scale, dBFS</p> <p>levels reported in dBFS are always r.m.s. Full scale level, 0 dBFS, is the level of a dc-free 997-Hz sine wave whose undithered positive peak value is positive digital full scale, leaving the code corresponding to negative digital full scale unused</p> <p>Note 1 to entry: It is invalid to use dBFS for non-r.m.s. levels. Because the definition of full scale is based on a sine wave, the level of signals with a crest factor lower than that of a sine wave may exceed 0 dBFS. In particular, square wave signals may reach +3,01 dBFS.</p>		N/A
2	Modification to Clause 10		
10.6	Safeguards against acoustic energy sources		N/A
	Replace 10.6 of IEC 62368-1 with the following:		
10.6.1.1	Introduction		N/A

IEC 62368-1			
Clause	Requirement + Test	Result - Remark	Verdict
	<p>Safeguard requirements for protection against long-term exposure to excessive sound pressure levels from personal music players closely coupled to the ear are specified below. Requirements for earphones and headphones intended for use with personal music players are also covered. A personal music player is a portable equipment intended for use by an ordinary person, that:</p> <ul style="list-style-type: none"> – is designed to allow the user to listen to audio or audiovisual content / material; and – uses a listening device, such as headphones or earphones that can be worn in or on or around the ears; and – has a player that can be body worn (of a size suitable to be carried in a clothing pocket) and is intended for the user to walk around with while in continuous use (for example, on a street, in a subway, at an airport, etc.). <p>EXAMPLES Portable CD players, MP3 audio players, mobile phones with MP3 type features, PDAs or similar equipment.</p> <p>Personal music players shall comply with the requirements of either 10.6.2 or 10.6.3.</p> <p>NOTE 1 Protection against acoustic energy sources from telecom applications is referenced to ITU-T P.360.</p> <p>NOTE 2 It is the intention of the Committee to allow the alternative methods for now, but to only use the dose measurement method as given in 10.6.5 in future. Therefore, manufacturers are encouraged to implement 10.6.5 as soon as possible.</p> <p>Listening devices sold separately shall comply with the requirements of 10.6.6. These requirements are valid for music or video mode only. The requirements do not apply to:</p> <ul style="list-style-type: none"> – professional equipment; <p>NOTE 3 Professional equipment is equipment sold through special sales channels. All products sold through normal electronics stores are considered not to be professional equipment.</p> <ul style="list-style-type: none"> – hearing aid equipment and other devices for assistive listening; – the following type of analogue personal music players: <ul style="list-style-type: none"> • long distance radio receiver (for example, a multiband radio receiver or world band radio receiver, an AM radio receiver), and • cassette player/recorder; 		

IEC 62368-1			
Clause	Requirement + Test	Result - Remark	Verdict
	<p>NOTE 4 This exemption has been allowed because this technology is falling out of use and it is expected that within a few years it will no longer exist. This exemption will not be extended to other technologies.</p> <p>– a player while connected to an external amplifier that does not allow the user to walk around while in use.</p> <p>For equipment that is clearly designed or intended primarily for use by children, the limits of the relevant toy standards may apply.</p> <p>The relevant requirements are given in EN 71-1:2011, 4.20 and the related tests methods and measurement distances apply.</p>		
10.6.1.2	<p>Non-ionizing radiation from radio frequencies in the range 0 to 300 GHz</p> <p>The amount of non-ionizing radiation is regulated by European Council Recommendation 1999/519/EC of 12 July 1999 on the limitation of exposure of the general public to electromagnetic fields (0 Hz to 300 GHz). For intentional radiators, ICNIRP guidelines should be taken into account for Limiting Exposure to Time-Varying Electric, Magnetic, and Electromagnetic Fields (up to 300 GHz). For hand-held and body mounted devices, attention is drawn to EN 50360 and EN 50566.</p>		N/A
10.6.2	Classification of devices without the capacity to estimate sound dose		N/A
10.6.2.1	<p>General</p> <p>This standard is transitioning from short-term based (30 s) requirements to long-term based (40 hour) requirements. These clauses remain in effect only for devices that do not comply with sound dose estimation as stipulated in EN 50332-3.</p> <p>For classifying the acoustic output $LA_{eq,T}$, measurements are based on the A-weighted equivalent sound pressure level over a 30 s period.</p> <p>For music where the average sound pressure (long term $LA_{eq,T}$) measured over the duration of the song is lower than the average produced by the programme simulation noise, measurements may be done over the duration of the complete song. In this case, T becomes the duration of the song.</p> <p>NOTE Classical music, acoustic music and broadcast typically has an average sound pressure (long term $LA_{eq,T}$) which is much lower than the average programme simulation noise. Therefore, if</p>		N/A

IEC 62368-1			
Clause	Requirement + Test	Result - Remark	Verdict
	<p>the player is capable to analyse the content and compare it with the programme simulation noise, the warning does not need to be given as long as the average sound pressure of the song does not exceed the required limit.</p> <p>For example, if the player is set with the programme simulation noise to 85 dB, but the average music level of the song is only 65 dB, there is no need to give a warning or ask an acknowledgement as long as the average sound level of the song is not above the basic limit of 85 dB.</p>		
10.6.2.2	<p>RS1 limits (to be superseded, see 10.6.3.2)</p> <p>RS1 is a class 1 acoustic energy source that does not exceed the following:</p> <ul style="list-style-type: none"> – for equipment provided as a package (player with its listening device), and with a proprietary connector between the player and its listening device, or where the combination of player and listening device is known by other means such as setting or automatic detection, the $L_{Aeq,T}$ acoustic output shall be ≤ 85 dB when playing the fixed “programme simulation noise” described in EN 50332-1. – for equipment provided with a standardized connector (for example, a 3,5 phone jack) that allows connection to a listening device for general use, the unweighted r.m.s. output voltage shall be ≤ 27 mV (analogue interface) or -25 dBFS (digital interface) when playing the fixed “programme simulation noise” described in EN 50332-1. – The RS1 limits will be updated for all devices as per 10.6.3.2. 		N/A
10.6.2.3	<p>RS2 limits (to be superseded, see 10.6.3.3)</p> <p>RS2 is a class 2 acoustic energy source that does not exceed the following:</p> <ul style="list-style-type: none"> – for equipment provided as a package (player with its listening device), and with a proprietary connector between the player and its listening device, or when the combination of player and listening device is known by other means such as setting or automatic 130 detection, the $L_{Aeq,T}$ acoustic output shall be ≤ 100 dB(A) when playing the fixed “programme simulation noise” as described in EN 50332-1. – for equipment provided with a standardized connector (for example, a 3,5 phone jack) that allows connection to a listening device for general use, the unweighted r.m.s. output voltage shall be ≤ 150 mV (analogue interface) or -10 dBFS (digital interface) when playing the fixed “programme simulation noise” as described in EN 50332-1. 		N/A
10.6.2.4	<p>RS3 limits</p> <p>RS3 is a class 3 acoustic energy source that</p>		N/A

IEC 62368-1			
Clause	Requirement + Test	Result - Remark	Verdict
	exceeds RS2 limits.		
10.6.3	Classification of devices (new)		N/A
10.6.3.1	<p>General</p> <p>Previous limits (10.6.2) created abundant false negative and false positive PMP sound level warnings. New limits, compliant with The Commission Decision of 23 June 2009, are given below.</p>		N/A
10.6.3.2	<p>RS1 limits (new)</p> <p>RS1 is a class 1 acoustic energy source that does not exceed the following:</p> <ul style="list-style-type: none"> – for equipment provided as a package (player with its listening device), and with a proprietary connector between the player and its listening device, or where the combination of player and listening device is known by other means such as setting or automatic detection, the $L_{Aeq,T}$ acoustic output shall be ≤ 80 dB when playing the fixed “programme simulation noise” described in EN 50332-1. – for equipment provided with a standardized connector (for example, a 3,5 phone jack) that allows connection to a listening device for general use, the unweighted r.m.s. output voltage shall be ≤ 15 mV (analogue interface) or -30 dBFS (digital interface) when playing the fixed “programme simulation noise” described in EN 50332-1. 		N/A
10.6.3.3	<p>RS2 limits (new)</p> <p>RS2 is a class 2 acoustic energy source that does not exceed the following:</p> <ul style="list-style-type: none"> – for equipment provided as a package (player with its listening device), and with a proprietary connector between the player and its listening device, or where the combination of player and listening device is known by other means such as setting or automatic detection, the weekly sound exposure level, as described in EN 50332-3, shall be ≤ 80 dB when playing the fixed “programme simulation noise” described in EN 50332-1. – for equipment provided with a standardized connector (for example, a 3,5 phone jack) that allows connection to a listening device for general use, the unweighted r.m.s. output level, integrated over one week, as described in EN50332-3, shall be ≤ 15 mV (analogue interface) or -30 dBFS (digital interface) when playing the fixed “programme simulation noise” described in EN 50332-1. 		N/A
10.6.4	Requirements for maximum sound exposure		N/A
10.6.4.1	<p>Measurement methods</p> <p>All volume controls shall be turned to maximum during tests.</p>		N/A

IEC 62368-1			
Clause	Requirement + Test	Result - Remark	Verdict
	Measurements shall be made in accordance with EN 50332-1 or EN 50332-2 as applicable.		
10.6.4.2	<p>Protection of persons</p> <p>Except as given below, protection requirements for parts accessible to ordinary persons, instructed persons and skilled persons are given in 4.3.</p> <p>NOTE 1 Volume control is not considered a safeguard.</p> <p>Between RS2 and an ordinary person, the basic safeguard may be replaced by an instructional safeguard in accordance with Clause F.5, except that the instructional safeguard shall be placed on the equipment, or on the packaging, or in the instruction manual.</p> <p>Alternatively, the instructional safeguard may be given through the equipment display during use.</p> <p>The elements of the instructional safeguard shall be as follows:</p> <ul style="list-style-type: none"> – element 1a: the symbol , IEC 60417-6044 (2011-01) – element 2: “High sound pressure” or equivalent wording – element 3: “Hearing damage risk” or equivalent wording – element 4: “Do not listen at high volume levels for long periods.” or equivalent wording <p>An equipment safeguard shall prevent exposure of an ordinary person to an RS2 source without intentional physical action from the ordinary person and shall automatically return to an output level not exceeding what is specified for an RS1 source when the power is switched off.</p> <p>The equipment shall provide a means to actively inform the user of the increased sound level when the equipment is operated with an output exceeding RS1. Any means used shall be acknowledged by the user before activating a mode of operation which allows for an output exceeding RS1. The acknowledgement does not need to be repeated more than once every 20 h of cumulative listening time.</p> <p>NOTE 2 Examples of means include visual or audible signals. Action from the user is always needed.</p> <p>NOTE 3 The 20 h listening time is the accumulative listening time, independent of how often and how long the personal music player has been switched off.</p>		N/A

IEC 62368-1			
Clause	Requirement + Test	Result - Remark	Verdict
	A skilled person shall not be unintentionally exposed to RS3.		
10.6.5	Requirements for dose-based systems		N/A
10.6.5.1	<p>General requirements</p> <p>Personal music players shall give the warnings as provided below when tested according to EN 50332-3, using the limits from this clause.</p> <p>The manufacturer may offer optional settings to allow the users to modify when and how they wish to receive the notifications and warnings to promote a better user experience without defeating the safeguards. This allows the users to be informed in a method that best meets their physical capabilities and device usage needs. If such optional settings are offered, an administrator (for example, parental restrictions, business/educational administrators, etc.) shall be able to lock any optional settings into a specific configuration.</p> <p>The personal music player shall be supplied with easy to understand explanation to the user of the dose management system, the risks involved, and how to use the system safely. The user shall be made aware that other sources may significantly contribute to their sound exposure, for example work, transportation, concerts, clubs, cinema, car races, etc.</p>		N/A
10.6.5.2	<p>Dose-based warning and requirements</p> <p>When a dose of 100 % <i>CSD</i> is reached, and at least at every 100 % further increase of <i>CSD</i>, the device shall warn the user and require an acknowledgement. In case the user does not acknowledge, the output level shall automatically decrease to compliance with class RS1.</p> <p>The warning shall at least clearly indicate that listening above 100 % <i>CSD</i> leads to the risk of hearing damage or loss.</p>		N/A
10.6.5.3	<p>Exposure-based requirements</p> <p>With only dose-based requirements, cause and effect could be far separated in time, defying the purpose of educating users about safe listening practice. In addition to dose-based requirements, a PMP shall therefore also put a limit to the short-term sound level a user can listen at.</p> <p>The exposure-based limiter (EL) shall automatically reduce the sound level not to exceed 100 dB(A) or 150 mV integrated over the past 180 s, based on methodology defined in EN 50332-3.</p> <p>The EL settling time (time from starting level reduction to reaching target output) shall be 10 s or</p>		N/A

IEC 62368-1			
Clause	Requirement + Test	Result - Remark	Verdict
	<p>faster.</p> <p>Test of EL functionality is conducted according to EN 50332-3, using the limits from this clause. For equipment provided as a package (player with its listening device), the level integrated over 180 s shall be 100 dB or lower. For equipment provided with a standardized connector, the unweighted level integrated over 180 s shall be no more than 150 mV for an analogue interface and no more than -10 dBFS for a digital interface.</p> <p>NOTE In case the source is known not to be music (or test signal), the EL may be disabled.</p>		
10.6.6	Requirements for listening devices (headphones, earphones, etc.)		N/A
10.6.6.1	<p>Corded listening devices with analogue input</p> <p>With 94 dB LAeq acoustic pressure output of the listening device, and with the volume and sound settings in the listening device (for example, built-in volume level control, additional sound features like equalization, etc.) set to the combination of positions that maximize the measured acoustic output, the input voltage of the listening device when playing the fixed “programme simulation noise” as described in EN 50332-1 shall be ≥ 75 mV.</p> <p>NOTE The values of 94 dB and 75 mV correspond with 85 dB and 27 mV or 100 dB and 150 mV.</p>		N/A
10.6.6.2	<p>Corded listening devices with digital input</p> <p>With any playing device playing the fixed “programme simulation noise” described in EN 50332-1, and with the volume and sound settings in the listening device (for example, built-in volume level control, additional sound features like equalization, etc.) set to the combination of positions that maximize the measured acoustic output, the LAeq, T acoustic output of the listening device shall be ≤ 100 dB with an input signal of -10 dBFS.</p>		N/A
10.6.6.3	<p>Cordless listening devices</p> <p>In cordless mode,</p> <ul style="list-style-type: none"> – with any playing and transmitting device playing the fixed programme simulation noise described in EN 50332-1; and – respecting the cordless transmission standards, where an air interface standard exists that specifies the equivalent acoustic level; and – with volume and sound settings in the receiving device (for example, built-in volume level control, additional sound features like equalization, etc.) set to the combination of positions that maximize the measured acoustic output for the above mentioned programme simulation noise, the LAeq, T acoustic 		N/A

IEC 62368-1							
Clause	Requirement + Test				Result - Remark		Verdict
	output of the listening device shall be ≤ 100 dB with an input signal of -10 dBFS.						
10.6.6.4	Measurement method <i>Measurements shall be made in accordance with EN 50332-2 as applicable.</i>						N/A
3	Modification to the whole document						
	Delete all the "country" notes in the reference document according to the following list:						P
	0.2.1	Note 1 and 2	1	Note 4 and 5	3.3.8.1	Note 2	
	3.3.8.3	Note 1	4.1.15	Note	4.7.3	Note 1 and 2	
	5.2.2.2	Note	5.4.2.3.2.2 Table 12	Note c	5.4.2.3.2.4	Note 1 and 3	
	5.4.2.3.2.4 Table 13	Note 2	5.4.2.5	Note 2	5.4.5.1	Note	
	5.4.10.2.1	Note	5.4.10.2.2	Note	5.4.10.2.3	Note	
	5.5.2.1	Note	5.5.6	Note	5.6.4.2.1	Note 2 and 3 and 4	
	5.6.8	Note 2	5.7.6	Note	5.7.7.1	Note 1 and Note 2	
	8.5.4.2.3	Note	10.2.1 Table 39	Note 3 and 4 and 5	10.5.3	Note 2	
	10.6.1	Note 3	F.3.3.6	Note 3	Y.4.1	Note	
	Y.4.5	Note					
4	Modification to Clause 1						
1	Add the following note: <i>NOTE Z1 The use of certain substances in electrical and electronic equipment is restricted within the EU: see Directive 2011/65/EU.</i>						P
5	Modification to 4.Z1						

IEC 62368-1			
Clause	Requirement + Test	Result - Remark	Verdict
4.Z1	<p>Add the following new subclause after 4.9:</p> <p>To protect against excessive current, short-circuits and earth faults in circuits connected to an a.c. mains, protective devices shall be included either as integral parts of the equipment or as parts of the building installation, subject to the following, a), b) and c):</p> <p>a) except as detailed in b) and c), protective devices necessary to comply with the requirements of B.3.1 and B.4 shall be included as parts of the equipment;</p> <p>b) for components in series with the mains input to the equipment such as the supply cord, appliance coupler, r.f.i. filter and switch, short-circuit and earth fault protection may be provided by protective devices in the building installation;</p> <p>c) it is permitted for pluggable equipment type B or permanently connected equipment, to rely on dedicated overcurrent and short-circuit protection in the building installation, provided that the means of protection, e.g. fuses or circuit breakers, is fully specified in the installation instructions.</p> <p>If reliance is placed on protection in the building installation, the installation instructions shall so state, except that for pluggable equipment type A the building installation shall be regarded as providing protection in accordance with the rating of the wall socket outlet.</p>	Replaced.	P
6	Modification to 5.4.2.3.2.4		
5.4.2.3.2.4	<p>Add the following to the end of this subclause:</p> <p>The requirement for interconnection with external circuit is in addition given in EN 50491-3:2009.</p>	Added.	N/A
7	Modification to 10.2.1		
10.2.1	<p>Add the following to ^{c)} and ^{d)} in table 39:</p> <p>For additional requirements, see 10.5.1.</p>	No such radiation from the equipment.	N/A

IEC 62368-1			
Clause	Requirement + Test	Result - Remark	Verdict
8	Modification to 10.5.1		
10.5.1	<p>Add the following after the first paragraph:</p> <p>For RS 1 compliance is checked by measurement under the following conditions:</p> <p>In addition to the normal operating conditions, all controls adjustable from the outside by hand, by any object such as a tool or a coin, and those internal adjustments or pre-sets which are not locked in a reliable manner, are adjusted so as to give maximum radiation whilst maintaining an intelligible picture for 1 h, at the end of which the measurement is made.</p> <p>NOTE Z1 Soldered joints and paint lockings are examples of adequate locking.</p> <p>The dose-rate is determined by means of a radiation monitor with an effective area of 10 cm², at any point 10 cm from the outer surface of the apparatus.</p> <p>Moreover, the measurement shall be made under fault conditions causing an increase of the high voltage, provided an intelligible picture is maintained for 1 h, at the end of which the measurement is made.</p> <p>For RS1, the dose-rate shall not exceed 1 µSv/h taking account of the background level.</p> <p>NOTE Z2 These values appear in Directive 96/29/Euratom of 13 May 1996.</p>	LED indicator used.	N/A
9	Modification to G.7.1		
G.7.1	<p>Add the following note:</p> <p>NOTE Z1 The harmonized code designations corresponding to the IEC cord types are given in Annex ZD.</p>		P

IEC 62368-1			
Clause	Requirement + Test	Result - Remark	Verdict
10	Modification to Bibliography		
	<p>Add the following notes for the standards indicated:</p> <p>IEC 60130-9 NOTE Harmonized as EN 60130-9. IEC 60269-2 NOTE Harmonized as HD 60269-2. IEC 60309-1 NOTE Harmonized as EN 60309-1. IEC 60364 NOTE some parts harmonized in HD 384/HD 60364 series. IEC 60601-2-4 NOTE Harmonized as EN 60601-2-4. IEC 60664-5 NOTE Harmonized as EN 60664-5. IEC 61032:1997 NOTE Harmonized as EN 61032:1998 (not modified). IEC 61508-1 NOTE Harmonized as EN 61508-1. IEC 61558-2-1 NOTE Harmonized as EN 61558-2-1. IEC 61558-2-4 NOTE Harmonized as EN 61558-2-4. IEC 61558-2-6 NOTE Harmonized as EN 61558-2-6. IEC 61643-1 NOTE Harmonized as EN 61643-1. IEC 61643-21 NOTE Harmonized as EN 61643-21. IEC 61643-311 NOTE Harmonized as EN 61643-311. IEC 61643-321 NOTE Harmonized as EN 61643-321. IEC 61643-331 NOTE Harmonized as EN 61643-331.</p>		P
11	ADDITION OF ANNEXES		
ZB	ANNEX ZB, SPECIAL NATIONAL CONDITIONS (EN)		
4.1.15	<p>Denmark, Finland, Norway and Sweden</p> <p>To the end of the subclause the following is added: Class I pluggable equipment type A intended for connection to other equipment or a network shall, if safety relies on connection to reliable earthing or if surge suppressors are connected between the network terminals and accessible parts, have a marking stating that the equipment shall be connected to an earthed mains socket-outlet.</p> <p>The marking text in the applicable countries shall be as follows:</p> <p>In Denmark: "Apparatets stikprop skal tilsluttes en stikkontakt med jord som giver forbindelse til stikproppens jord." In Finland: "Laite on liitettävä suojakoskettimilla varustettuun pistorasiaan" In Norway: "Apparatet må tilkoples jordet stikkontakt" In Sweden: "Apparaten skall anslutas till jordat uttag"</p>	<p>The equipment is Class I equipment. The marking text must be provided when marketed in applicable countries.</p>	N/A

IEC 62368-1			
Clause	Requirement + Test	Result - Remark	Verdict
4.7.3	<p>United Kingdom</p> <p>To the end of the subclause the following is added:</p> <p>The torque test is performed using a socket-outlet complying with BS 1363, and the plug part shall be assessed to the relevant clauses of BS 1363. Also see Annex G.4.2 of this annex</p>	The equipment is not direct plug-in equipment.	N/A
5.2.2.2	<p>Denmark</p> <p>After the 2nd paragraph add the following:</p> <p>A warning (marking safeguard) for high touch current is required if the touch current exceeds the limits of 3,5 mA a.c. or 10 mA d.c.</p>	No high touch current.	N/A
5.4.11.1 and Annex G	<p>Finland and Sweden</p> <p>To the end of the subclause the following is added:</p> <p>For separation of the telecommunication network from earth the following is applicable:</p> <p>If this insulation is solid, including insulation forming part of a component, it shall at least consist of either</p> <ul style="list-style-type: none"> • two layers of thin sheet material, each of which shall pass the electric strength test below, or • one layer having a distance through insulation of at least 0,4 mm, which shall pass the electric strength test below. <p>If this insulation forms part of a semiconductor component (e.g. an optocoupler), there is no distance through insulation requirement for the insulation consisting of an insulating compound completely filling the casing, so that clearances and creepage distances do not exist, if the component passes the electric strength test in accordance with the compliance clause below and in addition</p> <ul style="list-style-type: none"> • passes the tests and inspection criteria of 5.4.8 with an electric strength test of 1,5 kV multiplied by 1,6 (the electric strength test of 5.4.9 shall be performed using 1,5 kV), <p>and</p> <ul style="list-style-type: none"> • is subject to routine testing for electric strength during manufacturing, using a test voltage of 1,5 kV. <p>It is permitted to bridge this insulation with a capacitor complying with EN 60384-14:2005, subclass Y2.</p> <p>A capacitor classified Y3 according to EN 60384-14:2005, may bridge this insulation under the following conditions:</p>	No TNV circuits.	N/A

IEC 62368-1			
Clause	Requirement + Test	Result - Remark	Verdict
	<ul style="list-style-type: none"> the insulation requirements are satisfied by having a capacitor classified Y3 as defined by EN 60384-14, which in addition to the Y3 testing, is tested with an impulse test of 2,5 kV defined in 5.4.11; the additional testing shall be performed on all the test specimens as described in EN 60384-14; <p>the impulse test of 2,5 kV is to be performed before the endurance test in EN 60384-14, in the sequence of tests as described in EN 60384-14.</p>		
5.5.2.1	<p>Norway</p> <p>After the 3rd paragraph the following is added:</p> <p>Due to the IT power system used, capacitors are required to be rated for the applicable line-to-line voltage (230 V).</p>	Considered.	P
5.5.6	<p>Finland, Norway and Sweden</p> <p>To the end of the subclause the following is added:</p> <p>Resistors used as basic safeguard or bridging basic insulation in class I pluggable equipment type A shall comply with G.10.1 and the test of G.10.2.</p>	No such resistors.	N/A
5.6.1	<p>Denmark</p> <p>Add to the end of the subclause</p> <p>Due to many existing installations where the socket-outlets can be protected with fuses with higher rating than the rating of the socket-outlets the protection for pluggable equipment type A shall be an integral part of the equipment.</p> <p><i>Justification:</i></p> <p>In Denmark an existing 13 A socket outlet can be protected by a 20 A fuse.</p>	Considered.	P
5.6.4.2.1	<p>Ireland and United Kingdom</p> <p>After the indent for pluggable equipment type A, the following is added:</p> <p>– the protective current rating is taken to be 13 A, this being the largest rating of fuse used in the mains plug.</p>	Considered.	P
5.6.4.2.1	<p>France</p> <p>After the indent for pluggable equipment type A, the following is added:</p> <p>– in certain cases, the protective current rating of the circuit supplied from the mains is taken as 20 A instead of 16 A.</p>	Considered.	P

IEC 62368-1			
Clause	Requirement + Test	Result - Remark	Verdict
5.6.5.1	To the second paragraph the following is added: The range of conductor sizes of flexible cords to be accepted by terminals for equipment with a rated current over 10 A and up to and including 13 A is: 1,25 mm ² to 1,5 mm ² in cross-sectional area.	See above.	N/A
5.6.8	Norway To the end of the subclause the following is added: Equipment connected with an earthed mains plug is classified as class I equipment . See the Norway marking requirement in 4.1.15. The symbol IEC 60417-6092, as specified in F.3.6.2, is accepted.	Considered.	P
5.7.6	Denmark To the end of the subclause the following is added: The installation instruction shall be affixed to the equipment if the protective conductor current exceeds the limits of 3,5 mA a.c. or 10 mA d.c.	No high protective conductor current.	N/A

IEC 62368-1			
Clause	Requirement + Test	Result - Remark	Verdict
5.7.6.2	<p>Denmark</p> <p>To the end of the subclause the following is added: The warning (marking safeguard) for high touch current is required if the touch current or the protective current exceed the limits of 3,5 mA .</p>	No external circuits.	N/A
5.7.7.1	<p>Norway and Sweden</p> <p>To the end of the subclause the following is added: The screen of the television distribution system is normally not earthed at the entrance of the building and there is normally no equipotential bonding system within the building. Therefore the protective earthing of the building installation needs to be isolated from the screen of a cable distribution system.</p> <p>It is however accepted to provide the insulation external to the equipment by an adapter or an interconnection cable with galvanic isolator, which may be provided by a retailer, for example.</p> <p>The user manual shall then have the following or similar information in Norwegian and Swedish language respectively, depending on in what country the equipment is intended to be used in:</p> <p>“Apparatus connected to the protective earthing of the building installation through the mains connection or through other apparatus with a connection to protective earthing – and to a television distribution system using coaxial cable, may in some circumstances create a fire hazard. Connection to a television distribution system therefore has to be provided through a device providing electrical isolation below a certain frequency range (galvanic isolator, see EN 60728-11)”</p> <p>NOTE In Norway, due to regulation for CATV-installations, and in Sweden, a galvanic isolator shall provide electrical insulation below 5 MHz. The insulation shall withstand a dielectric strength of 1,5 kV r.m.s., 50 Hz or 60 Hz, for 1 min.</p> <p>Translation to Norwegian (the Swedish text will also be accepted in Norway):</p> <p>“Apparater som er koplet til beskyttelsesjord via nettplugg og/eller via annet jordtilkoplede utstyr – og er tilkoplede et koaksialbasert kabel-TV nett, kan forårsake brannfare. For å unngå dette skal det ved tilkopling av apparater til kabel-TV nett installeres en galvanisk isolator mellom apparatet og kabel-TV nettet.”</p> <p>Translation to Swedish:</p>	Not such system.	N/A

IEC 62368-1			
Clause	Requirement + Test	Result - Remark	Verdict
	"Apparater som är kopplad till skyddsjord via jordat vägguttag och/eller via annan utrustning och samtidigt är kopplad till kabel-TV nät kan i vissa fall medföra risk för brand. För att undvika detta skall vid anslutning av apparaten till kabel-TV nät galvanisk isolator finnas mellan apparaten och kabel-TV nätet."		
8.5.4.2.3	United Kingdom Add the following after the 2 nd dash bullet in 3 rd paragraph: An emergency stop system complying with the requirements of IEC 60204-1 and ISO 13850 is required where there is a risk of personal injury.		N/A
B.3.1 and B.4	Ireland and United Kingdom The following is applicable: To protect against excessive currents and short-circuits in the primary circuit of direct plug-in equipment , tests according to Annexes B.3.1 and B.4 shall be conducted using an external miniature circuit breaker complying with EN 60898-1, Type B, rated 32A. If the equipment does not pass these tests, suitable protective devices shall be included as an integral part of the direct plug-in equipment , until the requirements of Annexes B.3.1 and B.4 are met	The equipment is not direct plug-in equipment.	N/A
G.4.2	Denmark To the end of the subclause the following is added: Supply cords of single phase appliances having a rated current not exceeding 13 A shall be provided with a plug according to DS 60884-2-D1:2011. CLASS I EQUIPMENT provided with socket-outlets with earth contacts or which are intended to be used in locations where protection against indirect contact is required according to the wiring rules shall be provided with a plug in accordance with standard sheet DK 2-1a or DK 2-5a. If a single-phase equipment having a RATED CURRENT exceeding 13 A or if a polyphase equipment is provided with a supply cord with a plug, this plug shall be in accordance with the standard sheets DK 6-1a in DS 60884-2-D1 or EN 60309-2. Mains socket outlets intended for providing power to Class II apparatus with a rated current of 2,5 A shall be in accordance DS 60884-2-D1:2011 standard sheet DKA 1-4a. Other current rating socket outlets shall be in		N/A

IEC 62368-1			
Clause	Requirement + Test	Result - Remark	Verdict
	<p>compliance with Standard Sheet DKA 1-3a or DKA 1-1c.</p> <p>Mains socket-outlets with earth shall be in compliance with DS 60884-2-D1:2011 Standard Sheet DK 1-3a, DK 1-1c, DK1-1d, DK 1-5a or DK 1-7a</p> <p><i>Justification:</i> Heavy Current Regulations, Section 6c</p>		
G.4.2	<p>United Kingdom</p> <p>To the end of the subclause the following is added:</p> <p>The plug part of direct plug-in equipment shall be assessed to BS 1363: Part 1, 12.1, 12.2, 12.3, 12.9, 12.11, 12.12, 12.13, 12.16, and 12.17, except that the test of 12.17 is performed at not less than 125 °C. Where the metal earth pin is replaced by an Insulated Shutter Opening Device (ISOD), the requirements of clauses 22.2 and 23 also apply.</p>	The equipment is not direct plug-in equipment.	N/A
G.7.1	<p>United Kingdom</p> <p>To the first paragraph the following is added:</p> <p>Equipment which is fitted with a flexible cable or cord and is designed to be connected to a mains socket conforming to BS 1363 by means of that flexible cable or cord shall be fitted with a 'standard plug' in accordance with the Plugs and Sockets etc. (Safety) Regulations 1994, Statutory Instrument 1994 No. 1768, unless exempted by those regulations.</p> <p>NOTE "Standard plug" is defined in SI 1768:1994 and essentially means an approved plug conforming to BS 1363 or an approved conversion plug.</p>		N/A
G.7.1	<p>Ireland</p> <p>To the first paragraph the following is added: Apparatus which is fitted with a flexible cable or cord shall be provided with a plug in accordance with Statutory Instrument 525: 1997, "13 A Plugs and Conversion Adapters for Domestic Use Regulations: 1997. S.I. 525 provides for the recognition of a standard of another Member State which is equivalent to the relevant Irish Standard</p>		N/A
G.7.2	<p>Ireland and United Kingdom</p> <p>To the first paragraph the following is added: A power supply cord with a conductor of 1,25 mm² is allowed for equipment which is rated over 10 A and up to and including 13 A.</p>		N/A
ZC	ANNEX ZC, NATIONAL DEVIATIONS (EN)		

IEC 62368-1			
Clause	Requirement + Test	Result - Remark	Verdict
10.5.2	<p>Germany</p> <p>The following requirement applies:</p> <p>For the operation of any cathode ray tube intended for the display of visual images operating at an acceleration voltage exceeding 40 kV, authorization is required, or application of type approval (Bauartzulassung) and marking.</p> <p><i>Justification:</i> German ministerial decree against ionizing radiation (Röntgenverordnung), in force since 2002-07-01, implementing the European Directive 96/29/EURATOM.</p> <p>NOTE Contact address: Physikalisch-Technische Bundesanstalt, Bundesallee 100, D-38116 Braunschweig, Tel.: Int+49-531-592-6320, Internet: http://www.ptb.de</p>	No CRT within the equipment.	N/A

IEC 62368-1			
Clause	Requirement + Test	Result - Remark	Verdict

ZD	IEC and CENELEC CODE DESIGNATIONS FOR FLEXIBLE CORDS (EN)		
	Type of flexible cord	Code designations	
		IEC	CENELEC
	PVC insulated cords		
	Flat twin tinsel cord	60227 IEC 41	H03VH-Y
	Light polyvinyl chloride sheathed flexible cord	60227 IEC 52	H03VV-F H03VVH2-F
	Ordinary polyvinyl chloride sheathed flexible cord	60227 IEC 53	H05VV-F H05VVH2-F
	Rubber insulated cords		
	Braided cord	60245 IEC 51	H03RT-F
	Ordinary tough rubber sheathed flexible cord	60245 IEC 53	H05RR-F
	Ordinary polychloroprene sheathed flexible cord	60245 IEC 57	H05RN-F
	Heavy polychloroprene sheathed flexible cord	60245 IEC 66	H07RN-F
	Cords having high flexibility		
	Rubber insulated and sheathed cord	60245 IEC 86	H03RR-H
	Rubber insulated, crosslinked PVC sheathed cord	60245 IEC 87	H03RV4-H
	Crosslinked PVC insulated and sheathed cord	60245 IEC 88	H03V4V4-H
	Cords insulated and sheathed with halogen-free thermoplastic compounds		
	Light halogen-free thermoplastic insulated and sheathed flexible cords		H03Z1Z1-F H03Z1Z1H2-F
	Ordinary halogen-free thermoplastic insulated and sheathed flexible cords		H05Z1Z1-F H05Z1Z1H2-F

N/A

IEC 62368-1			
Clause	Requirement + Test	Result - Remark	Verdict

ATTACHMENT TO TEST REPORT			
IEC 62368-1 U.S.A. AND CANADA NATIONAL DIFFERENCES (AUDIO/VIDEO, INFORMATION AND COMMUNICATION TECHNOLOGY EQUIPMENT – PART 1: SAFETY REQUIREMENTS)			
Differences according to : CSA/UL 62368-1:2019			
TRF template used: : IECEE OD-2020-F3, Ed. 1.1			
Attachment Form No. : US_CA_ND_IEC62368_1E			
Attachment Originator : UL(US)			
Master Attachment : Dated 2021-02-04			
Copyright © 2021 IEC System for Conformity Testing and Certification of Electrical Equipment (IECEE), Geneva, Switzerland. All rights reserved.			
IEC 62368-1 - US and Canadian National Differences Special National Conditions based on Regulations and Other National Differences			
1 (1DV.1) (1.3)	All equipment is to be designed to allow installation in accordance with the National Electrical Code (NEC), ANSI/NFPA 70, the Canadian Electrical Code (CEC), Part 1, CAN/CSA C22.1, and when applicable, the National Electrical Safety Code, IEEE C2. Also, for such equipment marked or otherwise identified, installation is allowed per the Standard for the Protection of Information Technology Equipment, ANSI/NFPA 75.	In accordance with the National Electrical Code (NEC) and the Canadian Electrical Code (CEC) part 1 CAN/CSA C22.1, ANSI/NFPA 70, and unless marked or otherwise identified, the Standard for Electronic Computer/Data-Processing Equipment, ANSI/NFPA 75.	P
1 (1DV.2.1)	This standard includes additional requirements for equipment used for entertainment purposes intended for installation in general patient care areas of health care facilities. See Annex DVB.	Not such application.	N/A
1 (1DV.2.2)	This standard includes additional requirements for equipment intended for mounting under cabinets. See Annex DVC.	Not such application.	N/A
1 (1DV.2.3)	IEC 62368-3 clause 5 for DC power transfer at ES1 or ES2 voltage levels is considered informative. IEC 62368-3 clause 6 for remote power feeding telecommunication (RFT) circuits is considered normative (see ITU K.50). Alternatively, equipment with RFT circuits are given in either UL 2391 or CSA/UL 60950-21. RFT-C circuits are not permitted unless the RFT-C circuit complies with RFT-V limits ($\leq 200V$ per conductor to earth).	Not such application.	N/A
1 (1DV.3)	For protection against direct lightning strikes, reference is made to NFPA 780 and CAN/CSA-B72 for additional requirements.	Not such application.	N/A

IEC 62368-1			
Clause	Requirement + Test	Result - Remark	Verdict
1 (DV.5)	Additional requirements apply to some forms of power distribution equipment, including sub-assemblies.	Considered.	P
4.1 (4.1.17)	<i>For lengths exceeding 3.05 m, external interconnecting cable assemblies are required to be a suitable cable type (e.g., DP, CL2) specified in the NEC.</i>	Not exceeding 3.05 m.	N/A
	<i>For lengths 3.05 m or less, external interconnecting cable assemblies that are not types specified in the NEC generally are required to have special construction features and identification markings.</i>	Overall acceptance has to be evaluated during the national approval process.	N/A
4.6 (4.6.2)	Wire-wrap terminals have special construction and performance requirements.	No such parts.	N/A
4.8 (4.8.3, 4.8.4.5, 4.8.5)	Coin / button cell batteries have modified special construction and performance requirements.	No such parts.	N/A
5.4.2.3.2 (5.4.2.3.2.1)	<i>Surge Arrestors and Transient Voltage Surge Suppressors installed external to the equipment are required to comply with the appropriate NEC and CEC requirements.</i>	No such parts.	N/A
5.5.9	Receptacles, rated 125-V, single phase, 15- or 20-A accessible to either ordinary, instructed, or skilled persons are required to be provided with GFCI Protection for Personnel if the equipment containing the receptacles is installed outdoors. The protection devices are required to comply with UL 943, and CAN/CSA C22.2 No.144.	No outdoor equipment.	N/A
5.6.3	Protective earthing conductors comply with the minimum conductor sizes in Table G.7, except as required by Table G.7ADV.1 for cord connected equipment, or Annex DVH for permanently connected equipment.	An appliance inlet provided that is connected by an approved appliance coupler serves as main protective earthing terminal. No power supply cord is provided.	N/A

IEC 62368-1			
Clause	Requirement + Test	Result - Remark	Verdict
5.7.8 (5.7.8.1)	Equipment intended to receive telecommunication ringing signals is required to comply with a special touch current measurement tests.	No TNV circuits within the equipment.	N/A
6.5.1	PS3 wiring outside a fire enclosure is required to comply with single fault testing in B.4, or be current limited per one of the permitted methods.	No such parts.	N/A
Annex F (F.3.3.9)	Output terminals provided for supply of other equipment, except mains supply, are required to be marked with a maximum rating or reference to equipment permitted to be connected.	No DC output connector is provided.	N/A
Annex F (F.3.7)	Outdoor Enclosures are required to be classified and marked in accordance with UL 50 or 50E, or CAN/CSA C22.2 No. 94.1 or 94.2.	No outdoor equipment.	N/A
Annex G (G.7)	Permanent connection of equipment to the mains supply by a power supply cord is not permitted, except for certain equipment, such as ATMs.	The equipment is not permanent connection equipment.	N/A
	Power supply cords are required to have attachment plugs rated not less than 125 percent of the rated current of the equipment.	No power supply cord is provided.	N/A
	Flexible power supply cords are required to be compatible with Article 400 of the NEC, and Tables 11 and 12 of the CEC.	See above.	N/A
	Minimum cord length is required to be 1.5 m, with certain constructions such as external power supplies allowed to consider both input and output cord lengths into the requirement. Power supply cords are required to be no longer than 4.5 m in length if used in ITE Rooms.	See above.	N/A
	Power supply cords for outdoor equipment are required to be suitable outdoor use type as required by Section 400.4 of the NEC and Rule 4-012 of the CEC, i.e., marked "W."	No outdoor equipment.	N/A
Annex H.2	Continuous ringing signals under normal operating conditions up to 16 mA only are permitted if the equipment is subjected to special installation and performance restrictions.	No TNV circuits within the equipment.	N/A
Annex H.4	For circuits with other than ringing signals and with voltages exceeding 42.4 V _{peak} or 60 V _{d.c.} , the maximum acceptable current through a 2000 ohm resistor (or greater) connected across the voltage source with other loads disconnected is 7.1 mA peak or 30 mA d.c. under normal operating conditions.	No TNV circuits within the equipment.	N/A
Annex Q (Q.3)	Equipment with paired conductor and/or coax communications cables/wiring connected to building wiring are required to have special voltage, current, power and marking requirements.	The equipment not intended to be used within such environments.	N/A

IEC 62368-1			
Clause	Requirement + Test	Result - Remark	Verdict
Annex DVA (1)	Equipment that is designed such that it may be powered from a separate electrical service, is required to meet applicable requirements for service equipment for control and protection of services and their installation and complies with Article 230 of the National Electrical Code (NEC), NFPA 70 and Section 6 of the Canadian Electrical Code, Part I, CSA C22.1.	The equipment not intended to be used within such environments.	N/A
	Equipment intended for use in spaces used for environmental air (plenums) are subjected to special flammability requirements for heat and visible smoke release.	The equipment not intended to be used within such environments.	N/A
	For ITE room applications, automated information storage systems with combustible media greater than 0.76 m ³ (27 cu ft) are required to have a provision for connection of either automatic sprinklers or a gaseous agent extinguishing system with an extended discharge.	Not such equipment.	N/A
	Consumer products designed or intended primarily for children 12 years of age or younger are subject to additional requirements in accordance with U.S. and Canadian Regulations.	The equipment is not for children used.	N/A
	Baby monitors are required to additionally comply with ASTM F2951, Consumer Safety Specification for Baby Monitors.	Not a baby monitors.	N/A
	Storage batteries and battery management equipment, other than associated with lead-acid batteries, and including battery backup systems that are not an integral part of stationary AV and ICT equipment, such as provided in separate cabinets, are required to be certified (listed) to the appropriate standard(s) for such storage batteries and equipment.	Not such equipment.	N/A
Annex DVA (5.6)	For Pluggable Equipment Type A, the protection in the installation is assumed to be 20A.	Considered.	P
Annex DVA (6.3)	The maximum quantity of flammable liquid stored in equipment is required to comply with NFPA 30.	No flammable liquids within the equipment.	N/A
Annex DVA (6.4.8)	For ITE room applications, enclosures with combustible material measuring greater than 0.9 m ² (10 sq ft) or a single dimension greater than 1.8 m (6 ft) are required to have a flame spread rating of 50 or less. For equipment with the same dimensions for other applications, an external surface that is not a fire enclosure requires a minimum flammability classification of V-1.	No such application.	N/A
Annex DVA (10.3)	Equipment with lasers is required to meet the U.S. Code of Federal Regulations 21 CFR 1040 (and the Canadian Radiation Emitting Devices Act, REDR C1370).	No such parts.	N/A

IEC 62368-1			
Clause	Requirement + Test	Result - Remark	Verdict
Annex DVA (10.5)	Equipment that produces ionizing radiation is required to comply with the U.S. Code of Federal Regulations, 21 CFR 1020 (and the Canadian Radiation Emitting Devices Act, REDR C1370).	No such parts.	N/A
Annex DVA (F.3.3.4)	Equipment for use on a.c. mains supply systems with a neutral and more than one phase conductor (e.g. 120/240 V, 3-wire) require a special marking format for electrical ratings. Additional considerations apply for voltage ratings that exceed the attachment cap rating or that are lower than the "Normal Operating Condition" in Table 2 of CAN/CSA C22.2 No. 235."	Single phase only.	N/A
Annex DVA (F.3.3.6)	Equipment identified for ITE (computer) room installation is required to be marked with the rated current.	Not such application.	N/A
Annex DVA (G.1)	Vertically-mounted disconnect switches and circuit breakers are required to have the "on" position indicated by the handle in the up position.	No such parts.	N/A
Annex DVA (G.3.4)	Suitable NEC/CEC branch circuit protection rated at the maximum circuit rating is required for all standard supply outlets and receptacles (such as supplied in power distribution units) if the supply branch circuit protection is not suitable.	No standard supply outlets, receptacles, medium-base or smaller lampholders are provided.	N/A
	Where a fuse is used to provide Class 2 or Class 3 current limiting, it is not operator-accessible unless it is non- interchangeable.	No such parts.	N/A
Annex DVA (G.4.2)	Equipment with isolated ground (earthing) receptacles is required to comply with NEC 250.146(D) and CEC 10-400 and 10-612.	No such parts.	N/A
Annex DVA (G.4.3)	Interconnection of units by conductors supplied by a limited power source, or a Class 2 circuit defined in the NEC/CEC may have field wiring connections other than specified in DVH.3, such as wire-wrap and crimp-on types, if the limited power source and Class 2 circuits are separated from all other circuits by barriers, routing or fixing.	No such parts.	N/A
Annex DVA (G.5.3)	Power distribution transformers distributing power at 100 volts or more, and rated 10 kVA or more, require special transformer overcurrent protection.	No such parts.	N/A
Annex DVA (G.5.4)	Motor control devices are required for cord-connected equipment with a mains-connected motor if the equipment is rated more than 12 A, or if the equipment has a nominal voltage rating greater than 120 V, or if the motor is rated more than 1/3 hp (locked rotor current over 43 A).	No such parts.	N/A
Annex DVA (G.7)	Flexible cords used outdoors are required to have the suffix "W" marked on the flexible cord.	No such parts.	N/A

IEC 62368-1			
Clause	Requirement + Test	Result - Remark	Verdict
Annex DVA (M)	For ITE room applications, equipment with battery systems capable of supplying 750 VA for five minutes are required to have a battery disconnect means that may be connected to the ITE room remote power-off circuit.	Not such application.	N/A
Annex DVA (Q)	If applicable per NEC 725.121(C), some limited power sources supplied from AV/ICT equipment are required to have a label indicating the maximum voltage and maximum current, or maximum voltage and nominal current output for each connection point. Where multiple connection points have the same rating, a single label is permitted to be used.	Not applicable for the equipment.	N/A
	Wiring terminals intended to supply Class 2 outputs in accordance with the NEC or CEC Part 1 are required to be marked with the voltage rating and "Class 2" or equivalent. The marking is located adjacent to the terminals and visible during wiring.	Not applicable for the equipment.	N/A
	Applicable parts of Chapter 8 of the NEC, and Rules 54 and 60 of the CEC, may be applicable to ITE installed outdoors with connections to communication systems.	No outdoor equipment.	N/A
Annex DVB (1)	Additional requirements apply for equipment used for entertainment purposes intended for installation in general patient care areas of health care facilities.	Not such application.	N/A
Annex DVC (1)	Additional requirements apply for equipment intended for mounting under kitchen cabinets.	Not such application.	N/A
Annex DVE (4.1.1)	Some equipment, components, sub-assemblies and materials associated with the risk of fire, electric shock, or personal injury are required to have component or material ratings in accordance with the applicable national (U.S. and Canadian) component or material requirements. These equipment and components include: appliance couplers, attachment plugs, battery backup systems, circuit breakers, communication circuit accessories, connectors (used for current interruption of non-LPS circuits), direct plug-in equipment, electrochemical capacitor modules (energy storage modules with ultracapacitors), enclosures (outdoor), flexible cords and cables, fuses (branch circuit), ground-fault current interrupters, interconnecting cables, modular data centers, power supply cords, some power distribution equipment, printed wiring, protectors for communications circuits, receptacles, surge protective devices, vehicle battery adapters, wire connectors, and wire and cables.	UL approved components are used. Refer to table 4.1.2 of IEC 62368-1 test report for details.	P

IEC 62368-1			
Clause	Requirement + Test	Result - Remark	Verdict
Annex DVH	Equipment for permanent connection to the mains supply is subjected to additional requirements.	The equipment is not permanently connected equipment.	N/A
Annex DVH (DVH.1)	Wiring methods (terminals, leads, etc.) used for the connection of the equipment to the mains are required to be in accordance with the NEC/CEC.	The equipment is pluggable equipment type A.	N/A
Annex DVH (DVH.3.2)	Terminals for permanent wiring, including protective earthing terminals, are required to be suitable for U.S./Canadian wire gauge sizes, rated 125 percent of the equipment rating, and be specially marked when specified.	No terminals for permanent wiring.	N/A
	Wire binding screws are not permitted to attach conductors larger than 10 AWG (5.3 mm ²).	No wire binding screws.	N/A
Annex DVH (DVH.4)	Permanently connected equipment is required to have a suitable wiring compartment and wire bending space.	The equipment is not permanently connected equipment.	N/A
Annex DVH (DVH 5.5)	Equipment connected to a centralized d.c. power system, and having one pole of the DC mains input terminal connected to the main protective earthing terminal in the equipment, is required to comply with special earthing, wiring, marking and installation instruction requirements.	The equipment not connected to a centralized d.c. power system.	N/A
Annex DVI (6.7)	Equipment intended for connection to telecommunication network outside plant cable is required to be protected against overvoltage from power line crosses.	No TNV circuits within the equipment.	N/A
Annex DVJ (10.6.1)	Equipment connected to a telecommunication and cable distribution networks and supplied with an earphone intended to be held against, or in the ear is required to comply with special acoustic pressure requirements.	No TNV circuits within the equipment.	N/A

IEC 62368-1			
Clause	Requirement + Test	Result - Remark	Verdict

ATTACHMENT TO TEST REPORT IEC 62368-1 (AUSTRALIA / NEW ZEALAND) NATIONAL DIFFERENCES (Audio/video, information and communication technology equipment)			
Differences according to : AS/NZS 62368.1:2022			
TRF template used: : IECEE OD-2020-F3, Ed. 1.1			
Attachment Form No. : AU_NZ_ND_IEC62368_1E			
Attachment Originator : JAS-ANZ			
Master Attachment : 2022-07-01			
Copyright © 2020 IEC System for Conformity Testing and Certification of Electrical Equipment (IECEE), Geneva, Switzerland. All rights reserved.			
	National Differences		
Appendix ZZ	Variations to IEC 62368-1:2018 (ED. 3.0) for Australia and New Zealand		P
ZZ1 Scope	This Appendix lists the normative variations to IEC 62368-1:2018 (ED. 3.0)		P
ZZ2 Variations	The following modifications are required for Australian/New Zealand conditions:		-
2	<p>After the first paragraph, <i>add</i> the following: The Australian or Australian/New Zealand Standards listed below are modified adoptions of, or not equivalent to, the IEC normative references and are required for the application of this Standard. All references in the source text to those IEC normative references shall be replaced by references to the corresponding Australian or Australian/New Zealand Standards. Australian or Australian/New Zealand Standards that are identical adoptions of international normative references may be used interchangeably</p> <ul style="list-style-type: none"> -AS/NZS 3112, <i>Approval and test specification—Plugs and socket-outlets</i> -AS/NZS 3123, <i>Approval and test specification—Plugs, socket-outlets and couplers for general industrial application</i> -AS/NZS 3191, <i>Electric flexible cords</i> -AS/NZS 60884.1, <i>Plugs and socket-outlets for household and similar purposes, Part 1: General requirements</i> -IEC 60086-2 <i>Primary batteries — Part 2: Physical and electrical specifications</i> -AS/NZS 60065, <i>Audio, video and similar electronic apparatus—Safety requirements (IEC 60065:2015 (ED.8.0) MOD)</i> -AS/NZS 60320.1, <i>Appliance couplers for household and similar general purposes,</i> 		-

IEC 62368-1			
Clause	Requirement + Test	Result - Remark	Verdict
	<p><i>Part 1: General requirements (IEC 60320-1, Ed.2.1 (2007) MOD)</i></p> <p><i>-AS/NZS 60320.2.2, Appliance couplers for household and similar general purposes</i></p> <p><i>Part 2.2: Interconnection couplers for household and similar equipment (IEC 60320-2-2, Ed.2.0 (1998) MOD)</i></p> <p><i>-AS/NZS 60695.2.11, Fire hazard testing, Part 2.11: Glowing/hot wire based test methods—Glow-wire flammability test method for end-products</i></p> <p><i>-AS/NZS 60695.11.5, Fire hazard testing, Part 11.5: Test flames—Needle-flame test method—Apparatus, confirmatory test arrangement and guidance</i></p> <p><i>-AS/NZS 60695.11.10, Fire hazard testing, Part 11.10: Test flames—50 W horizontal and vertical flame test methods</i></p> <p><i>-AS/NZS 60884.1, Plugs and socket-outlets for household and similar purposes, Part 1: General requirements</i></p> <p><i>-AS/NZS 60950.1, Information technology equipment—Safety, Part 1: General requirements (IEC 60950-1, Ed.2.2 (2013), MOD)</i></p> <p><i>IEC 61032:1997, Protection of persons and equipment by enclosures—Probes for verification</i></p> <p><i>-AS/NZS 61558.1, Safety of Power Transformers, Power Supplies, Reactors and Similar Products, Part 1: General requirements and tests (IEC 61558-1 Ed 3, MOD)</i></p> <p><i>-AS/NZS 61558.2.16, Safety of transformers, reactors, power supply units and similar products for voltages up to 1 100 V, Part 2.16: Particular requirements and tests for switch mode power supply units and transformers for switch mode power supply units.</i></p>		
4.7.2	<p>Requirements</p> <p><i>Delete the text of the second paragraph and replace with the following:</i></p> <p><i>Equipment with a plug portion, suitable for insertion into a 10 A 3-pin flat-pin socket-outlet conforming to AS/NZS 3112, shall conform to the requirements in AS/NZS 3112 for equipment with integral pins for insertion into socket-outlets. Conformity is checked by inspection and, if necessary, by the tests in AS/NZS 3112.</i></p> <p><i>NOTE: Equipment with plug portions for use in countries other than Australia and New Zealand will need to conform to other countries' requirements</i></p> <p><i>Note Additional AS/NZS 3112 Appendix J,TRF is appended to end of this TRF.</i></p>		N/A

IEC 62368-1				
Clause	Requirement + Test	Result - Remark		Verdict
4.7.3	Compliance Criteria <i>Delete</i> this clause			N/A
4.8.1	General After second list, <i>add</i> the following: NOTE: Refer to the Consumer Goods (Products Containing Button/Coin Batteries) Safety Standard 2020 and Consumer Goods (Products Containing Button/Coin Batteries) Information Standard 2020 for more information on button cell batteries in Australia..			N/A
5.4.10.2.1	General <i>Delete</i> the first paragraph and <i>replace</i> with the following: In Australia, the separation is checked by the test given in both Clause 5.4.10.2.2 and Clause 5.4.10.2.3. In New Zealand, the separation is checked by the test given in either 5.4.10.2.2 or 5.4.10.2.3..			N/A
Table 28	<i>Delete</i> Table 28 and <i>replace</i> with the following:			N/A
Parts	Impulse test		Steady state test	
	New Zealand	Australia	New Zealand	Australia
Parts indicated in Clause 5.4.10.1 a) ^a	2.5 kV	7.0 kV for hand-held telephones and headsets, 2.5 kV for other equipment.	1.5 kV	3 kV
Parts indicated in Clause 5.4.10.1 b) and c) ^b	1.5 kV ^c		1.0 kV	1.5 kV
^a Surge suppressors shall not be removed. ^b Surge suppressors may be removed, provided that such devices pass the impulse test of Clause 5.4.10.2.2 when tested as components outside the equipment. ^c During this test, it is allowed for a surge suppressor to operate and for a sparkover to occur in a GDT.				
5.4.10.2.2	<i>Delete</i> "NOTE" and <i>replace</i> with "NOTE 1". After NOTE 1, <i>add</i> the following: NOTE 2: For Australia, the 7 kV impulse simulates lightning surges on typical rural and semi-rural network lines. NOTE 3: For Australia, the value of 2.5 kV for Clause 5.4.10.1 a) was chosen to ensure the adequacy of the insulation concerned and does not necessarily simulate likely overvoltages.			N/A
5.4.10.2.3	<i>Delete</i> "NOTE" and <i>replace</i> with "NOTE 1". After NOTE 1, <i>add</i> the following: NOTE 2: For Australia, where there are capacitors across the insulation under test, it is recommended that d.c. test voltages are used. NOTE 3: The 3 kV and 1.5 kV values for Australia have been determined considering the low frequency induced voltages from the power supply distribution system.			N/A

IEC 62368-1			
Clause	Requirement + Test	Result - Remark	Verdict
6	Electrically-caused fire		P
6.6	After Clause 6.6, <i>add</i> the new Clauses 6.201 as follows: 6.201 External power supplies, docking stations and other similar devices (see special national conditions)		N/A
8.6	Stability of equipment		N/A
Table 36	Footnote ^a , after first sentence, <i>add</i> the following: Equipment having displays with moving images shall include "television sets and display devices".		
8.6.1	After Clause 8.6.1 <i>add</i> the following new clauses: 8.6.201 Restraining Device fixing point (see special national conditions) 8.6.202 Restraining device (see special national conditions)		N/A
Annex F Paragraph F.3.3.4	Rated Voltage <i>Delete</i> "NOTE" and <i>replace</i> with NOTE1" After NOTE 1, <i>add</i> the following Equipment that is intended for connection to the supply mains in Australia and New Zealand shall be marked with: (a) A rated voltage of: <ul style="list-style-type: none"> • 230 V for single phase equipment • 400 V for poly phase equipment Or (b) A rated voltage range that includes: <ul style="list-style-type: none"> • 230 V for single phase equipment • 400 V for poly phase equipment NOTE 2: equipment that is not rated as above is not suitable for direct connection to the supply mains in Australia or new Zealand.		N/A
Annex F.3.3.5	After the list, <i>add</i> the following Equipment that is intended for connection to supply mains in Australia or New Zealand shall be marked with a rated frequency of 50 Hz or a rated frequency range or nominal value which includes 50Hz		N/A
Annex F.3.8	After "The DC output of an external power supply", insert "or docking stations and other similar external devices"		N/A

IEC 62368-1			
Clause	Requirement + Test	Result - Remark	Verdict
Annex G Paragraph G.4.2	Mains connectors 1 After "IEC 60320", insert "or AS/NZS 60320 series". 2 After "IEC 60906-1", insert "or AS/NZS 3123" 3 <i>After</i> first paragraph <i>add</i> the following: 10 A or 15 A 250 V flat pin plugs for the connection of equipment to mains-powered socket-outlets for household or similar general use shall comply with AS/NZS 3112 or AS/NZS 60884.1.		N/A
Paragraph G.5.3.1	Transformers, General 1 Third dashed point <i>replace</i> 'IEC 61558-1 and the relevant parts of IEC 61558-2' with 'AS/NZS 61558-1 and the relevant parts of AS/NZS 61558.2' 2 Fourth dashed point <i>replace</i> 'IEC 61558-2-16' with 'AS/NZS 61558.2.16'.		N/A
Annex G.7.1	Mains supply cords, General Fourth dashed paragraph, <i>replace</i> 'IEC 60320-1' with 'AS/NZS 60320.1'		N/A
Table G.7	Sizes of conductors 1 First column, second row, <i>delete</i> "6" and <i>replace</i> with "7.5" 2 Second column, second row, <i>delete</i> '0,75' and <i>replace</i> with '0.75 ^b 3 <i>Delete</i> NOTE 1. 4 <i>Replace</i> 'NOTE 2' with 'NOTE:'. 5 <i>Delete</i> 'Footnote b' and <i>replace</i> with the following: ^b This nominal cross-sectional area is only allowed for Class II appliances if the length of the power supply cord, measured between the point where the cord, or cord guard, enters the appliance, and the entry to the plug does not exceed 2 m (0.5 mm ² three-core supply flexible cords are not permitted; see AS/NZS 3191). 6 Footnote c <i>replace</i> 'IEC 60320-1' with 'AS/NZS 60320.1' 7 Footnote d <i>replace</i> 'IEC 60320-1' with 'AS/NZS 60320.1'		N/A
Annex M M 2.1	<i>Add</i> "IEC 60086-2" to the list		N/A

IEC 62368-1			
Clause	Requirement + Test	Result - Remark	Verdict
Annex M Paragraph M.3.2	Test method Delete "NOTE" and replace with "NOTE 1" After NOTE 1 <i>add</i> the following: NOTE 2: In cases where the voltage source is provided by power from an unassociated power source, consideration should be given to the effects of possible single fault conditions in the unassociated equipment. If the power source is unknown then it should be assumed that the maximum limit of ES1 may be applied to the source input under assumed single fault conditions in the source when assessing the charging circuit in the equipment under test.		N/A
6.201	External power supplies, docking stations and other similar devices For external power supplies, docking stations and other similar devices, during and after abnormal operating conditions and during single fault conditions the output voltage— (a) at all ES1 outlets or connectors shall not increase by more than 10 % of the output rated voltage under normal operating conditions, measured after 3 s of introducing a single fault condition and after 3 s of introducing abnormal operating conditions; and (b) of a USB outlet or connector shall not increase by more than 3 V or 10 % of the output rated voltage under normal operating conditions, whichever is higher, measured after 3 seconds of introducing a single fault condition and after 3 s of introducing abnormal operating conditions For equipment with multiple rated voltages at the output, the requirements apply with the equipment configured for each output rated voltage in turn NOTE: This is intended to reduce the possibility of battery fire or explosion in attached equipment or accessories when charging secondary lithium batteries. The 3 s measurement delay is based on IEC document 108/742/INF, <i>TC 108, Standards Interpretation Panel Question 15 — Output voltage</i> , in relation to similar requirements in IEC 62368-3:2017. Conformity shall be checked by measurement, taking into account the abnormal operating conditions of Annex B.3 and the simulated single fault conditions of Annex B.4.		P

IEC 62368-1			
Clause	Requirement + Test	Result - Remark	Verdict
8.6.201	<p>Restraining device fixing point Freestanding-capable MS2 and MS3 television sets and display devices shall be provided with a fixing point to facilitate the anchoring of the equipment from toppling</p> <p>The fixing point shall conform to Clause 8.7 where the fixing point uses a wall, ceiling or other structure mount. Alternatively, the fixing point shall be capable of withstanding a pull equal to the mass of the equipment in all directions without damage</p> <p>Instructions for installation or instructions for use shall be provided to specify correct use of the fixing point</p>		N/A
8.6.202	<p>Restraining device MS2 and MS3 television sets and display devices shall be provided with a restraining device and associated hardware to attach to the television set or display device.</p> <p>The restraining device shall be capable of withstanding a pull equal to the mass of the equipment in all directions.</p> <p>Instructions for installation or instructions for use shall be provided to specify correct use of the fixing point</p>		N/A

IEC 62368-1			
Clause	Requirement + Test	Result - Remark	Verdict

ATTACHMENT TO TEST REPORT IEC 62368-1 SINGAPORE NATIONAL DIFFERENCES AUDIO/VIDEO, INFORMATION AND COMMUNICATION TECHNOLOGY EQUIPMENT - PART 1: SAFETY REQUIREMENTS			
Differences according to : Special National Conditions			
TRF template used: : IECEE OD-2020-F3, Ed. 1.1			
Attachment Form No. : SG_ND_IEC62368_1E			
Attachment Originator : Intertek Testing Services (Singapore) Pte Ltd			
Master Attachment : 2021-05-03			
Copyright © 2021 IEC System for Conformity Testing and Certification of Electrical Equipment (IECEE), Geneva, Switzerland. All rights reserved.			
	National Differences		P
	Not Applicable		-
Chapter 7	Special national conditions (if any) Controlled goods under Consumer Protection (Safety Requirements) Registration Scheme (CPS) are required to be tested to additional requirements stipulated by Enterprise Singapore in Chapter 7 of the CPS information booklet. The CPS information booklet is updated on an ongoing basis. At the point of testing, refer to the latest copy of the CPS information booklet for the minimum edition of standard to apply for testing of products under the CPS scheme and any new requirements. Link to CPS information booklet: https://www.enterprisesg.gov.sg/-/media/esg/files/quality-and-standards/consumer-protection/for-suppliers/cpsr/cps_infobooklet.pdf?la=en		N/A
3	All appliances must be tested to 230 VAC, 50 Hz.		P
4	Appliance fitted with voltage selector shall be tested as follows: Connect appliance to 230 VAC mains with voltage selector switch to settings not suitable for operation at 230 VAC.		P

IEC 62368-1			
Clause	Requirement + Test	Result - Remark	Verdict
5	All appliances (with tropical test requirements in applicable Standards) shall comply with the tropical condition test as stated in the relevant IEC Standards.		P
6	All Class I appliances (3-pin mains plug) must be fitted with 3-pin mains plugs complying with SS 145/SS 472 that are registered with the Authority.		N/A
7	a) All Class II appliances must be fitted with 2-pin mains plug complying with EN 50075. b) Class II appliances that are fitted with 3-pin mains plugs must use plugs that comply with SS 145 and registered with the Authority.		N/A
9	Detachable power cord set must be listed in the test report critical component list.		N/A
18	AC Adaptor incorporated with 13A socket-outlet to be tested to additional tests clauses 13, 17 and 18 of SS 246 (till 25/10/2021), or clauses 12.1 & 12.3 of SS 145 Part 3: 2020.		N/A
19	Supplier who is supplying AC adaptors with detachable interchangeable plug pins must include with its products, written instructions to inform customer on the type of detachable interchangeable plug pins that are approved and suitable to use in Singapore. These instructions are to be submitted to the Conformity Assessment Body for verification when applying for Certificate of Conformity.		N/A
20	For AC Adaptors supplied together with Personal Mobility Devices: <ol style="list-style-type: none"> 1. Registered Supplier to declare the model of the AC adaptor that is to be used with/ bundled together with the PMDs; 2. Registered Supplier to provide valid IEC 60950-1 or IEC 62368-1 test reports for certification and registration of the declared AC adaptor under the CPS scheme; and Registered Supplier to provide the UL 2272 test report as supporting document, showing that the listed AC adaptor in the UL 2272 test report is the model declared to be used with/ bundled together with the PMDs.		N/A



IEC 62368-1			
Clause	Requirement + Test	Result - Remark	Verdict
21	CD/ DVD ROMs (used in personal computers) to have test certificate showing that CD/DVD ROM has complied with IEC 60825- 1.		N/A
22	Modem card incorporated in the personal computer must be tested at set level (sub-clauses 5.1 & 6 of IEC 60950) or at component level.		N/A
23	Powerline Ethernet Adaptor incorporated with 13A socket-outlet, to be tested to additional test clauses 13, 17 & 18 of SS 246 (till 25/10/2021), or clauses 13, 17 & 18 of SS 145 Part 3: 2020.		N/A
	Other additional requirements which may be included in Chapter 7 of the information booklet in ongoing basis at the time of testing.		N/A

IEC 62368-1			
Clause	Requirement + Test	Result - Remark	Verdict

ATTACHMENT TO TEST REPORT IEC 62368-1 CHINA NATIONAL DIFFERENCES (AUDIO/VIDEO, INFORMATION AND COMMUNICATION TECHNOLOGY EQUIPMENT -PART 1: SAFETY REQUIREMENTS)			
Differences according to : GB 4943.1-2022			
TRF template used: : IECEE OD-2020-F3, Ed. 1.1			
Attachment Form No. : CN_ND_IEC62368_1E			
Attachment Originator : CQC			
Master Attachment : Dated 2022-12-01			
Copyright © 2020 IEC System for Conformity Testing and Certification of Electrical Equipment (IECEE), Geneva, Switzerland. All rights reserved.			
	National Differences		P
4.1.2	Use of components Add a paragraph: A component used shall comply with related requirements corresponding altitude of the equipment.		P
4.11	Add clause 4.11,as follows: Protection in PRIMARY CIRCUITS against overcurrent short-circuits and earth faults shall be provided as an integral part of the equipment except the device shall meet the all requirement of Fault conditions. If pluggable equipment type B or permanently connected equipment depends on protective devices outside the equipment for protection, this shall be stated in the installation instructions of the equipment, with requirements for short-circuit protection, over-current protection ,or both if necessary.		N/A
5.3.2.2	Contact requirements Amend the 2 nd paragraph of table 8 to be: For equipment intended to be used at altitude of 2000m to 5000m, the values in this table are multiplied by the multiplication factor corresponding altitude of 5000m.		P

IEC 62368-1			
Clause	Requirement + Test	Result - Remark	Verdict
5.4.2.5	<p>Multiplication factors for altitudes higher than 2 000 m above sea level</p> <p>Amend the 1st paragraph to be:</p> <p>For equipment to be operated at more than 2000 m above sea level and up to 5000m above sea level, the minimum CLEARANCE in tables 10,11 and 14,and resistance test voltages required in table 15, shall meet the requirements of 5000 m above sea level, This is multiplied by the multiplication factor corresponding altitude of 5000m in table 16.</p> <p>For equipment to be used at equal or less than 2000 m above sea level, the minimum CLEARANCE in tables 10, 11 and 14, and resistance test voltages required in table 15, shall meet the requirements of 2000 m above sea level. This is multiplied by the multiplication factor corresponding altitude of 2000m in table 16.</p> <p>Delete note 2 of Clause 5.4.2.5.</p>		P
5.4.5.1	<p>General</p> <p>Delete the 2nd paragraph of Clause 5.4.5.1: This test does not apply to equipment where one antenna terminal on the equipment is connected to earth in accordance with 5.6.7.</p> <p>Add the following:</p> <p>The Insulation resistance between CATV antenna coaxial sockets and protective earth of apparatus shall comply with BASIC INSULATION. If it's possible that CLASS II apparatus with CATV antenna coaxial sockets connect with protective earth of another CLASS I apparatus by other terminals, the insulation resistance between them shall comply with BASIC INSULATION as well.</p> <p>If antenna cable separated from the protective earth before connection to the apparatus, there is no requirements of Insulation resistance between them but F.4 requirements shall be meet.</p> <p>Delete "NOTE" of Clause 5.4.5.1</p>		N/A

IEC 62368-1			
Clause	Requirement + Test	Result - Remark	Verdict
5.4.8	<p>Humidity conditioning</p> <p>Amend clause 5.4.8 as follows :</p> <p>The humidity conditioning is conducted for 120 h in a cabinet or room containing air with ambient temperature (40±2) °C and a relative humidity of (93±3)%. During this conditioning, the component or subassembly is not energized.</p> <p>For equipment not to be operated at tropical climatic conditions, humidity conditioning is conducted for 48 h in a cabinet or room containing air with a relative humidity of (93±3) %. The temperature of the air, at all places where samples can be located, is maintained within 2 °C of any convenient value between 20 °C and 30 °C such that condensation does not occur.</p> <p>Add note: For equipment to be operated at 2000 m - 5000m above sea level, assessment and requirement of humidity conditioning for Insulation material properties are considered.</p> <p>Pre-processing conditions and requirements below 2000m can be used until additional data is available.</p>		P
6.4.9 Y.4.3	Delete references to ASTM and NEMA.		N/A
6.5.1	<p>General requirements</p> <p>Delete the text of the Note "Wire complying with UL 2556 VW-1 is considered to comply with these requirements".</p>		N/A
F.1	Amend the second paragraph of annex F.1 to be: Unless symbols are used or otherwise specified, safety related equipment markings, instructions, and instructional safeguards shall be in normative Chinese.		N/A

IEC 62368-1			
Clause	Requirement + Test	Result - Remark	Verdict
F.2.2	<p>After the first paragraph of annex F.2.2 ,add the following:</p> <p>For apparatus intended to be used at altitude not exceeding 2000m, a warning label containing the following or a similar appropriate wording or a symbol shown below shall fixed to the equipment at readily visible place. "Only used at altitude not exceeding 2000m." </p> <p>For apparatus intended to be used in not-tropical climate regions, a warning label containing the following or a similar appropriate wording or a symbol shown below shall fixed to the equipment at readily visible place. "Only used in not-tropical climate regions." </p> <p>If only symbol used, the explanation of the symbol shall be contained in the instruction manual.</p> <p>The statements above shall be given in a language acceptable to the regions where the apparatus is intended to be used.</p>		N/A
F.3.3.4	<p>After the last paragraph, Added:</p> <p>...for single rated voltage, "220 V" or three-phase "380V" shall be marked only. For a rating voltage range, 220 V or three-phase 380V shall be covered. For multiple rated voltages, one of them shall be 220 V or three-phase 380V and which default setting from manufacture shall be 220 V or three-phase 380V as well.</p>		N/A
F.3.3.5	<p>After the last paragraph, Added:</p> <p>Rated frequency shall be 50Hz or frequency range shall cover 50Hz.</p>		P
F.4	<p>Instructions</p> <p>Added:</p> <ul style="list-style-type: none"> - For apparatus incorporating antenna coaxial sockets which is non-separated with CATV network, a warning wording or a similar shall be given in the instruction manual: "A CATV cable intended to be connected to apparatus shall be separated with the protective earth of the apparatus, otherwise fire hazard might be caused." 		N/A
F.5	<p>Instructional safeguards</p> <p>In table F.2 , change 230V to 220V, change 400Y/230V 3Ø to 380 Y/220 V 3Ø</p>		P

IEC 62368-1			
Clause	Requirement + Test	Result - Remark	Verdict
G.4.2	Amend clause G.4.2 as follows : Plugs connected to the MAINS in apparatus shall comply with GB/T 1002,GB/T 1003,GB/T 2099.1 or GB/T11918 (All parts) series. Appliance coupler shall comply with GB/T 17465 (All parts) series or GB/T 11918 (All parts) series.		P
	Special national conditions (if any)		N/A
0.12	Add clause 0.12 Description of relevant information.		N/A
1	GB 4943.1-2022 applies to equipment used at altitudes not exceeding 5000m above sea level, For apparatus intended to be used at altitude not exceeding 2000m, The requirements can be appropriately reduced, but warning instructions shall be provided.. Revise the sixth paragraph of 1 as: In addition to specified by the manufacturer, this document assumes a maximum altitude of 5000m		P
B.2.6.1	Amend T_{ma} as follows: T_{ma} is the maximum ambient temperature permitted by the manufacturer's specification, or 35 °C, whichever is greater. Add note 1: For equipment not to be operated at tropical climatic conditions, T_{ma} is the maximum ambient temperature permitted by the manufacturer's specification, or 25 °C, whichever is greater. Add note 2: For equipment to be operated at 2000m-5000m above sea leave, its temperature test conditions and temperature limits are under consideration. temperature test conditions and temperature limits below 2000m can be used until additional data is available.		P
Annex Z (normative)	Added annex Z: Instructions of the new safety warning labels.		N/A
Annex AA (informative)	Added annex AA: Illustration relative to safety explanation in normative Chinese, Tibetan, Mongolian, Zhuang Language and Uighur.		N/A

IEC 62368-1			
Clause	Requirement + Test	Result - Remark	Verdict

<p style="text-align: center;">ATTACHMENT TO TEST REPORT</p> <p style="text-align: center;">IEC 62368-1:2018</p> <p style="text-align: center;">JAPAN NATIONAL DIFFERENCES</p> <p style="text-align: center;">AUDIO/VIDEO, INFORMATION AND COMMUNICATION TECHNOLOGY EQUIPMENT – PART 1: SAFETY REQUIREMENTS</p>			
Differences according to : J62368-1(2023)			
TRF template used: : IECEE OD-2020-F3:2022, Ed. 1.2			
Attachment Form No. : JP_ND_IEC62368_1E			
Attachment Originator : UL Solutions (JP)			
Master Attachment : Dated 2023-05-12			
Copyright © 2023 IEC System for Conformity Testing and Certification of Electrical Equipment (IECEE), Geneva, Switzerland. All rights reserved.			
	National Differences		--
4.1.2	Where the component, or a characteristic of a component, is a safeguard or a part of a safeguard, components shall comply with the requirements of this document or, where specified in a requirements clause, with the safety aspects of the relevant JIS component standards or IEC component standards, or components shall have properties equivalent to or better than these.	The component fulfils the relevant IEC standard.	P
5.6.1	Mains socket-outlet and interconnection coupler shall comply with Clause G.4.2A if they are incorporated as part of the equipment.	No socket-outlets provided.	N/A

IEC 62368-1			
Clause	Requirement + Test	Result - Remark	Verdict
5.6.2.1	<p>Connection for protective conductor of class 0I equipment provided with instructional safeguard in accordance with Clause F.3.6.1A is considered to make earlier and break later than supply connection.</p> <p>Mains plug having a lead wire for protective earthing connection of class 0I equipment shall comply with all of the following:</p> <ul style="list-style-type: none"> – Not to be used for equipment having a rated voltage of 150 V or more – Clip is not used for the earthing connection of the lead wire. – The lead wire for earthing is at least 10 cm long <p>If class 0I equipment provides an independent main protective earthing terminal and is intended to be installed by ordinary person, earthing wire shall be provided in the package of the equipment.</p>		N/A
5.6.2.2	Internal earthing conductor of the cord set that is covered by the sheath of mains cord and is formed together with mains plug and appliance connector need not be green-and-yellow.		N/A
5.6.3	<p>In case of class 0I equipment using power supply cord having two conductors (no earthing conductor), the conductor of protective earthing lead wire shall comply with either of the following:</p> <ul style="list-style-type: none"> – use of annealed copper wire with 1.6 mm diameter or corrosion-inhibiting metal wire having size and strength that are equivalent to or more than the above copper wire – single core cord or single core cable with 1.25 mm² or more cross-sectional area 		N/A
5.7.3	For class 0I equipment that is provided with mains socket-outlet in the configuration as specified in JIS C 8282 series, JIS C 8300 or JIS C 8303, or that is provided with mains appliance outlet as specified in JIS C 8283 series for the purpose of interconnection, the measurement is conducted on the system of the interconnected equipment having a single connection to the mains.		N/A
5.7.5	In case of class 0I equipment, touch current shall not exceed 1.41 mA peak or for sinusoidal wave, 1.0 mA r.m.s. when measured using the network specified in Figure 4 of IEC 60990:2016.		N/A

IEC 62368-1			
Clause	Requirement + Test	Result - Remark	Verdict
6.4.3.2	<p>A fuse complying with JIS C 6575 series or a fuse having equivalent characteristics shall open within 1 s.</p> <p>A fuse having time/current characteristics other than those specified in IEC 60127 shall be tested with the characteristics taken into account. In case of Class A fuse of JIS C 6575, replace "2.1 times" by "1.35 times" and in case of Class B fuse of JIS C 6575, replace "2.1 times" by "1.6 times".</p>		N/A
8.5.4.3.1	Only three-phase stationary equipment rated more than AC 200 V can be considered as being for use in locations where children are not likely to be present, when complying with Clause F.4.		N/A
8.5.4.3.2	For equipment installed where children may be present, an instructional safeguard shall be provided by easily understandable wording in accordance with Clause F.5, except that element 3 is optional.		P
8.5.4.3.4	The media destruction device is tested according to Clause V.1.2 with applicable jointed test probes to the opening. And then the wedge probe per Figure V.4 shall not contact any moving part.		N/A
8.5.4.3.5	<p>The wedge probe of Figure V.4 and applicable jointed test probes specified in Clause V.1.2 shall not contact any moving part.</p> <p>Instructional safeguard shall not be used instead of equipment safeguard for preventing access to hazardous moving parts.</p>		N/A
F.3.5.1	<p>When the mains socket-outlet is configured in accordance with JIS C 8282 series, JIS C 8300 or JIS C 8303, the assigned current or power shall be marked. If the voltage of the socket-outlet is the same as the mains voltage, the voltage need not be marked.</p> <p>Instructional safeguard of Class 0I equipment shall be provided with an instructional safeguard in accordance with Clause F.5 when a mains socket-outlet as specified in JIS C 8282 series, JIS C 8300 or JIS C 8303 to which class I equipment can be connected is provided in accordance with Clause G.4.2A except for the cases where the socket-outlet is accessible only to skilled persons.</p>		N/A
F.3.5.3	If the fuse is necessary for the safeguard function, the symbols indicating pre-arcing time-current characteristic shall be included.		P

IEC 62368-1			
Clause	Requirement + Test	Result - Remark	Verdict
F.3.6.1A	<p>Marking for class 0I equipment</p> <p>The requirements of Clauses F.3.6.1.1 and F.3.6.1.2 shall be applied to class 0I equipment.</p> <p>For class 0I equipment, a marking of instructions shall be provided regarding the earthing connection.</p> <p>In addition to the above, for class 0I equipment, an instruction to connect earthing before and disconnect earthing after the connection of supply conductors shall be marked on the visible place of the main body or shall be in the text of an accompanying document.</p>		N/A
F.3.6.2	Symbols, IEC 60417-5172 (2003-02) or IEC 60417-6092 (2011-10), shall not be used for class I equipment or class 0I equipment.		N/A
F.3.8A	<p>Attention marking for aging deterioration of CRT television</p> <p>Year of manufacture, standard usage period by design according to JIS C 9921-5 and cautionary statement for possible risks of aging deterioration when used beyond the specified period shall be marked on CRT television except for industrial use CRT television.</p>		N/A
F.4	<p>For audio equipment with terminals classified as ES3 in accordance with Table E.1, and for other equipment with terminals marked in accordance with F.3.6.1 and F.3.6.1A, the instructions shall require that the external wiring connected to these terminals shall be installed by a skilled person, or shall be connected by means of ready-made leads or cords that are constructed in a way that would prevent contact with any ES3 circuit.</p> <p>For class 0I equipment provided with independent main protective earthing terminal, where the cord for the protective earthing connection is not provided in the package of the equipment, if the protective earthing connection is made by instructed person or skilled person, the suitable installation instruction for the protective earthing connection shall be provided.</p>		N/A
G.3.2.1	The thermal link when tested as a separate component, shall comply with the requirements of JIS C 6691 or have properties equivalent to or better than that.		N/A

IEC 62368-1			
Clause	Requirement + Test	Result - Remark	Verdict
G.3.4	<p>Except for devices covered by Clause G.3.5, overcurrent protective devices used as a safeguard shall comply with the applicable JIS or IEC standard in accordance with 4.1.2 or shall have equivalent or better properties.</p> <p>Such a protective device shall have adequate breaking (rupturing) capacity to interrupt the maximum fault current (including short-circuit current) that can flow.</p>		N/A
G.4.1	This requirement does not apply to connectors covered in Clauses G.4.2 and G.4.2A.		N/A
G.4.2	<p>Mains connectors, mains plugs and socket-outlets shall comply with JIS C 8283 series, JIS C 8285, IEC 60309 series, JIS C 8282 series, JIS C 8300, JIS C 8303, or have equivalent or better properties.</p> <p>A power supply cord set provided with appliance connector that can fit appliance inlet complying with JIS C 8283-1 shall comply with JIS C 8286.</p> <p>Construction shall prevent mechanical stress not to transmit to the soldering part of appliance inlet terminal.</p> <p>When an equipment is rated not more than 125 V and all of the following are met, Type C14 and C18 appliance inlet complying with JIS C 8283-3 can be considered as rated 15 A.</p> <ul style="list-style-type: none"> – The temperature of appliance inlet does not exceed the value specified in JIS C 8283-1 under the most unfavourable normal operating condition as specified in Clause B.2.1. – "Use only designated cord set attached in this equipment" or equivalent text is described in the operating instruction. If the cord set is not provided in the package of the equipment, suitable information regarding to the cord set is described in the operating instruction. 		N/A
G.4.2A	Mains socket-outlet and interconnection coupler provided with the class II, class I and class 0I equipment respectively		N/A
G.7.1	A mains supply cord need not include the protective earthing conductor for class 0I equipment provided with independent protective earthing conductor.		N/A

IEC 62368-1			
Clause	Requirement + Test	Result - Remark	Verdict
G.7.2 Table G.7	Cross-sectional area of equipment rated up to and including 3 A shall be 0.75 mm ² .		N/A
G.7.6.1 Table G.9	The cross-sectional area of mains cords according to JIS C 3010 may comply with relevant Japanese wiring regulation. For cables other than those complying with JIS C 3662 series or JIS C 3663 series, the terminals shall be suitable for the size of the intended cables.		N/A

IEC 62368-1			
Clause	Requirement + Test	Result - Remark	Verdict

ATTACHMENT TO TEST REPORT IEC 62368-1:2018 SAUDI ARABIA NATIONAL DIFFERENCES (AUDIO/VIDEO, INFORMATION AND COMMUNICATION TECHNOLOGY EQUIPMENT PART 1: SAFETY REQUIREMENTS)			
Differences according to : National standard SASO-IEC 62368-1:2020			
TRF template used: : IECEE OD-2020-F3, Ed. 1.1			
Attachment Form No. : SA_ND_IEC62368_1E			
Attachment Originator : SASO			
Master Attachment : 2022-12-22			
Copyright © 2022 IEC System for Conformity Testing and Certification of Electrical Equipment (IECEE), Geneva, Switzerland. All rights reserved.			
	National Differences		N/A
	Plugs used for pluggable equipment comply with standard SASO-2203.	Must be checked when market into the country.	N/A
--	Frequency (Hz)		P
	60 Hz		P
--	Rated voltage (V)		P
	Single phase 230 V Three phase 400 V	Single phase	P

IEC 62368-1			
Clause	Requirement + Test	Result - Remark	Verdict

Equipment combined with two-pole plug (Class II)

Supplementary tests on plug portion according to EN 50075:1990

1. Dimensions (Clause 7 of EN 50075)

Plugs shall comply with standard size. (Standard sheet 1) P

2. Protection Against Electric Shock (Clause 8 of EN 50075)

2.1 Live parts of plugs with the exception of the bare metal parts of the pins, shall not be accessible. (Clause 8.1 of EN 50075) P

2.2 It shall not be possible to make connection between a pin of a plug and a live socket contact of a socket-outlet while the other pin is an accessible. (Clause 8.2 of EN 50075) P

2.3 External parts of plugs, with the exception of pins, shall be of insulating material. (Clause 8.3 of EN 50075) P

3. Construction (Clause 9 of EN 50075)

3.1 The plug cannot be opened by hand or by using a general purpose tool. (Clause 9.1 of EN 50075) P

3.2 Pins of plugs shall be solid and shall have adequate mechanical strength. (Clause 9.3 of EN 50075) P

3.3 Pins of plugs shall be locked against rotation and adequately fixed into the body of the plug. (Clause 9.4 of EN 50075) P

3.4 Plugs shall be provided with soldered, crimped or equally effective permanent connection. (Clause 9.5 of EN 50075) P

3.5 Plug shall be shaped in such a way and made of such a material that they can easily be withdrawn by hand from a socket-outlet. (by gripping the power supply's enclosure, Clause 9.6 of EN 50075) P

4. Resistance to Humidity (Clause 10 of EN 50075) N/A

The integrated pins were tested together with the power supply. (See test report for power supply)

5. Insulation Resistance and Electric Strength (Clause 11 of EN 50075) N/A

(See test report for power supply)

6. Mechanical Strength (Clause 13 of EN 50075)

Plug shall have adequate mechanical strength to withstand the stresses imposed during use. P

6.1 The plugs are pressed between two flat surfaces with a force of 150N for 5min. 15min after removal of the force, the plug shall not show such deformation as would result in undue alteration of the dimensions which ensure safety. P

IEC 62368-1			
Clause	Requirement + Test	Result - Remark	Verdict

(Clause 13.1 of EN 50075)

6.2	<p>The plug is tested in a tumbling barrel. (Clause 13.2 of EN 50075, fall number is shown in test report for power supply) After the test, the plug shall show no damage within the meaning of this standard, in particular: --- no part shall become detached or loosened. --- the pin shall not turn when a torque of 0.4Nm is applied. Note: A section of the pin is square constructed for preventing the rotation.</p>		N/A
6.3	<p>The pins is held in a suitable clamp in such a position that the straight part of a steel wire (D=1+-0.02mm, U-shaped) rests on the plug pin. The plug is caused to move backwards and forwards, so that the wire rubs along the pin. The number of the movements is 20 000, and the rate of the operation is 25 movements per min. (Clause 13.3 of EN 50075)</p> <p>After the test, the pin show no damage which may effect safety or impair the further use of the plug, in particular, the insulating sleeve shall not have punctured or rucked up.</p>		P
6.4	<p>A pull force of 40N is applied for 60s on each pin in turn in the direction of the longitudinal axis of the pin. The pull is applied 60min after the plug has been placed in a heating cabinet of 70°C. After the plug cooling down to ambient temperature, any pin shall not have displaced in the body of the plug more than 1mm. (Clause 13.4 of EN 50075)</p>		P
7.	Resistance to Heat and to Ageing (Clause 14 of EN 50075)		P
8.	Current-carrying Parts and Connections (Clause 15 of EN 50075)		
8.1	<p>Connection, electrical and mechanical, shall withstand the mechanical stresses occurring in normal use, and electrical connections shall be designed that contact pressure is not transmitted through insulating material. (Clause 15.1 & 15.2 of EN 50075)</p>		P
8.2	<p>Current-carrying parts shall be of copper or an alloy containing at least 58% of copper. (Clause 15.3 of EN 50075)</p>		P
9.	Creepage Distance, Clearances, and Distances Through Insulation (Clause 16 of EN 50075)		P
10.	Resistance of Insulating Material to Abnormal Heat and to fire (Clause 17 of EN 50075)		P

IEC 62368-1			
Clause	Requirement + Test	Result - Remark	Verdict

Dimension Checking for Two-pin plug according to EN50075

DIMENSIONS		
	Checked by means of measurement according to EN50075 Standard sheet 1 (see appendix no.5)	P

Position	Requirement (mm)	Measured (mm)	Verdict
1	25.6 – 26.6	25.84	P
2	13 – 14.4	13.98	P
3	45°	45°	P
4	R5 – 6	R5.4	P
5	34.6 – 36	35.09	P
6	18-19.2 in the plane of the engagement face	18.15	P
	17-18 at the ends of the pins	17.55	P
7	4min	-	N/A
8	φ3.8max	φ3.42	P
9	10-11	10.05	P
10	18.5 – 19.5	19.12	P
11	φ3.94 - φ4.06	φ3.98	P
	Dimensions of position 1, 2 and 3 shall not be exceeded within a distance of 18mm from the engagement face of the plug	19.15	P
	The edges of the metal parts shall be either chamfered or rounded off	Rounded off	P

IEC 62368-1

Clause	Requirement + Test	Result - Remark	Verdict
--------	--------------------	-----------------	---------

EN50075: 1990 Standard sheet 1

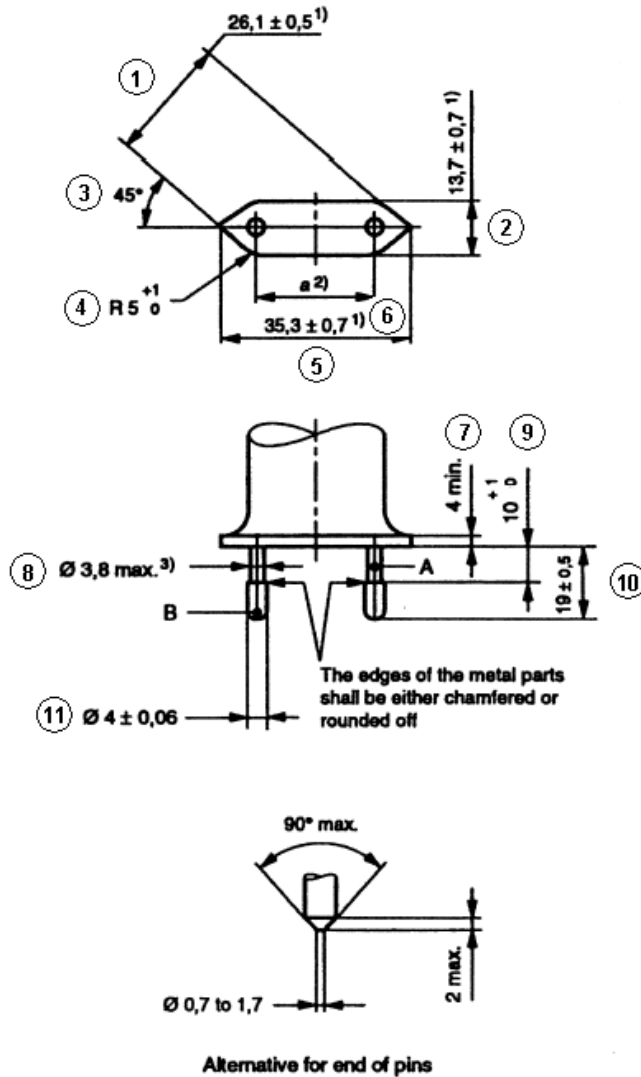
*Dimensions in millimetres*

¹⁾ These dimensions shall not be exceeded within a distance of 18 mm from the engagement face of the plug.

²⁾ Dimension *a* is:

18 mm to 19,2 mm in the plane of the engagement face;

17 mm to 18 mm at the ends of the pins.

³⁾ This dimension may be increased to 4 mm within a distance of 4 mm from the engagement face of the plug.

Pin ends shall be rounded, or conical as shown in detail sketch.

The sketches are not intended to govern design except as regards the dimensions shown.

IEC 62368-1			
Clause	Requirement + Test	Result - Remark	Verdict

Photo for plug portion according to EN 50075:1990



IEC 62368-1			
Clause	Requirement + Test	Result - Remark	Verdict

APPENDIX NO.10: MECHANICAL DURABILITY TEST FOR NON-STANDARD INTERCHANGEABLE PLUG ADAPTERS ACCORDING IEC 61984: 2008

IEC 61984: 2008										
6.14.1	MECHANICAL ENDURANCE (COC AND CBC)		P							
	A connector, either COC or CBC, shall meet the mechanical operations without load as specified in the DS or in the manufacturer's specification (preferred numbers of operating cycles are given in Table 4a).	100 cycles	P							
7.3.9	MECHANICAL OPERATION		P							
	The object of this test is to assess the mechanical operational endurance of a connector either CBC or COC in the normal operational mode without electrical load.		P							
	The test shall be carried out according to test 9a of IEC 60512, under the following conditions, unless otherwise specified.		P							
	Test conditions:		P							
	The specimens shall be engaged and disengaged by means of a device simulating normal operating conditions.		P							
	The preparation and mounting of the specimen shall be as in normal use.		P							
	The type and cross sectional area of the cable/wire bundle to be used shall be specified by the manufacturer or by the DS.		P							
	The number of operating cycles shall be specified by the manufacturer or by the DS.		P							
	Preferred values are indicated in Table 4a.	100 cycles	P							
	The speed of insertion and withdrawal shall be approximately 0,01 m/s with a rest in the unmated position of approximately 30 s.		P							
Table 4	Mechanical and electrical durability		P							
	Table 4a – Operating cycles – Preferred values		P							
	<table border="1"> <thead> <tr> <th>Operating cycles - Preferred values</th> </tr> </thead> <tbody> <tr><td>10</td></tr> <tr><td>50</td></tr> <tr><td>100</td></tr> <tr><td>500</td></tr> <tr><td>1 000</td></tr> <tr><td>5 000</td></tr> </tbody> </table>	Operating cycles - Preferred values	10	50	100	500	1 000	5 000	100 cycles	P
Operating cycles - Preferred values										
10										
50										
100										
500										
1 000										
5 000										

Photograph of the Equipment under test (EUT)

External view for GTM96300 series



External view for GTM96300 series



Internal view for GTM96300 series (Class I)

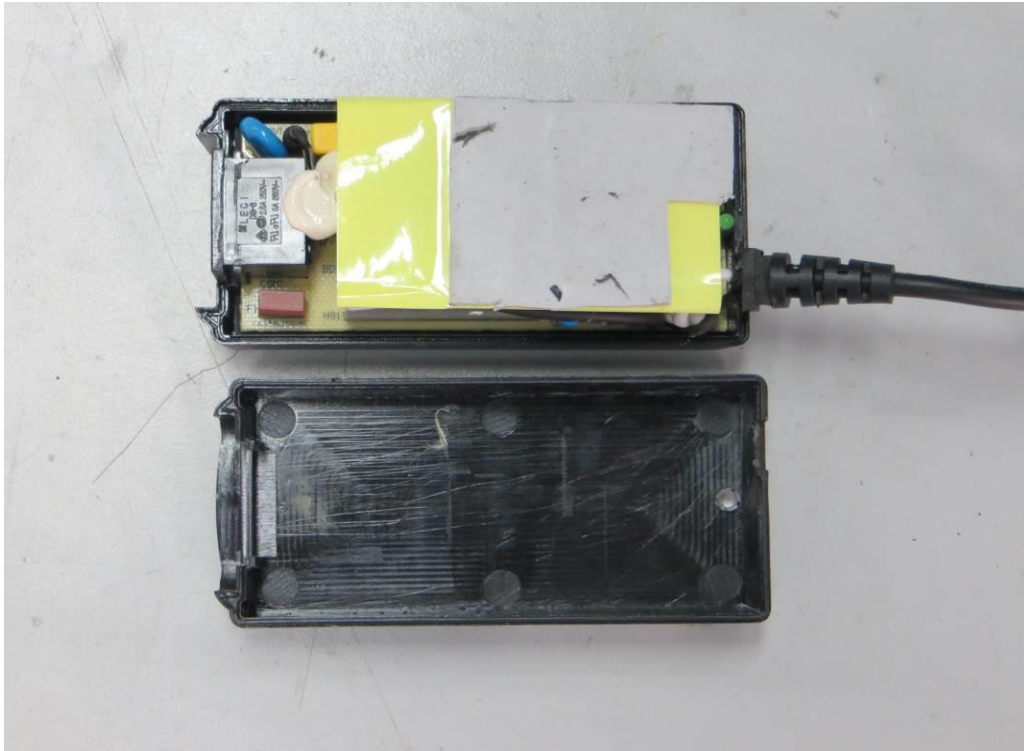

Internal view for GTM96300 series (Class I)

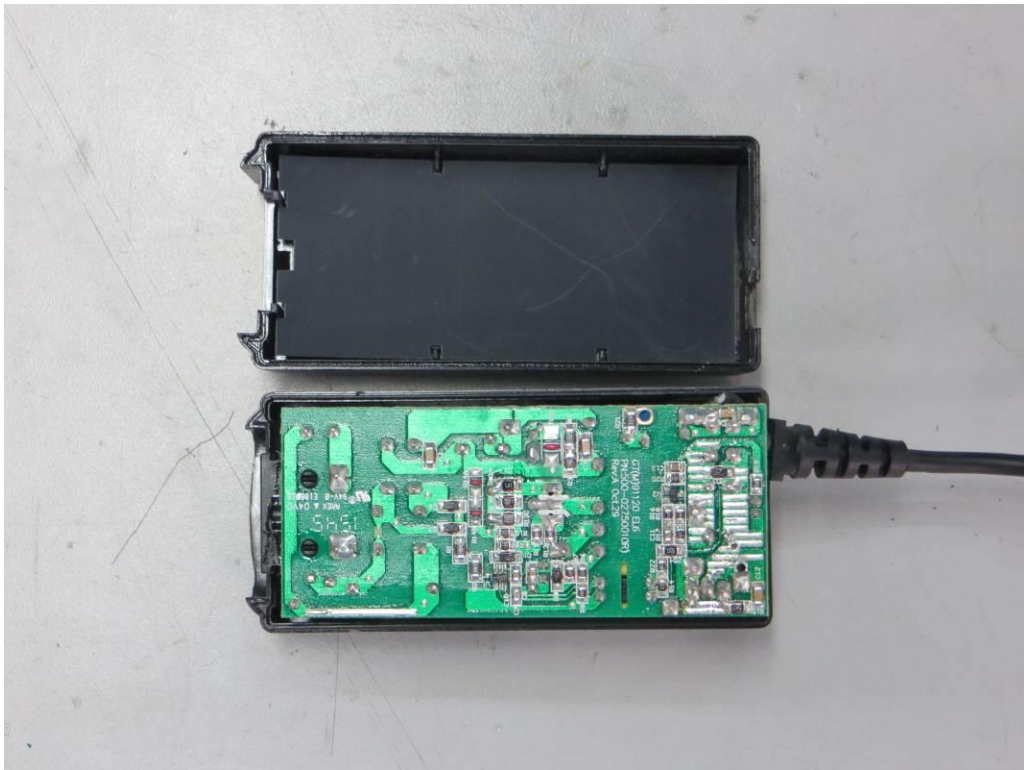

PCB for GTM96300 series (Class I)

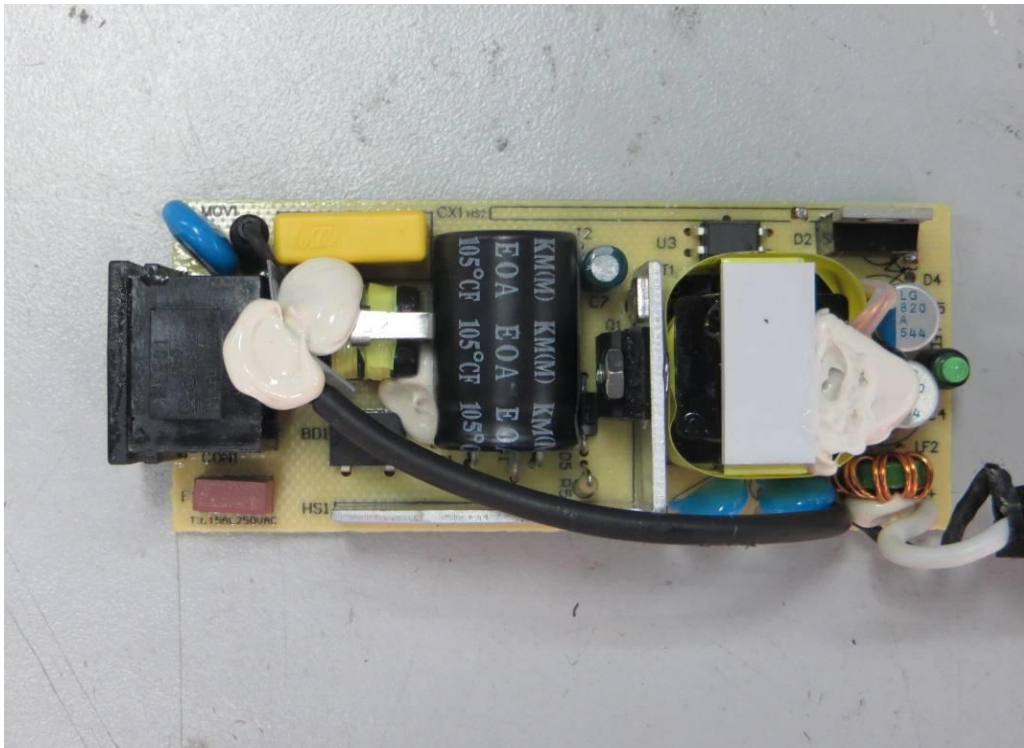

PCB for GTM96300 series (Class I)

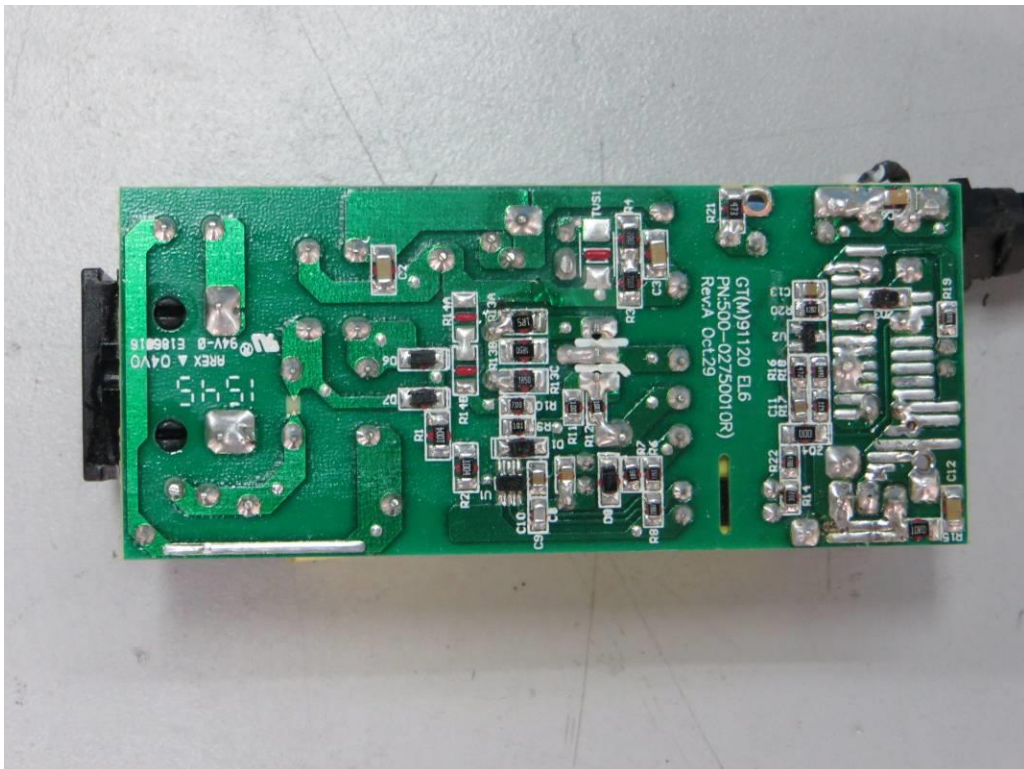

Internal view for GTM96300 series (Class II)

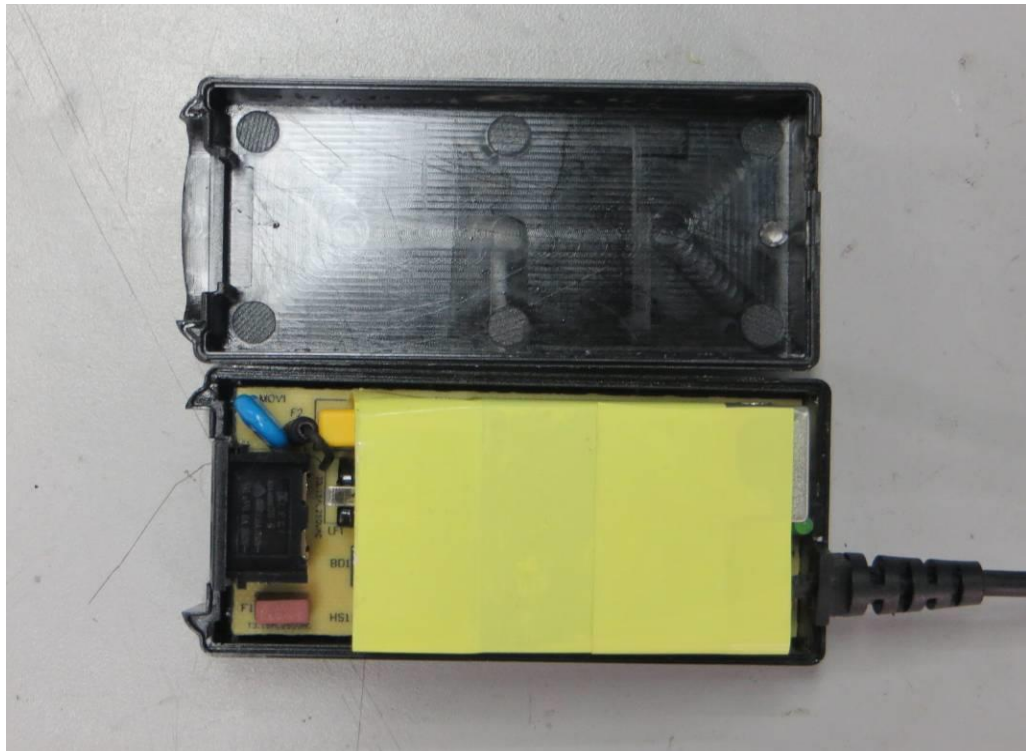

Internal view for GTM96300 series (Class II)

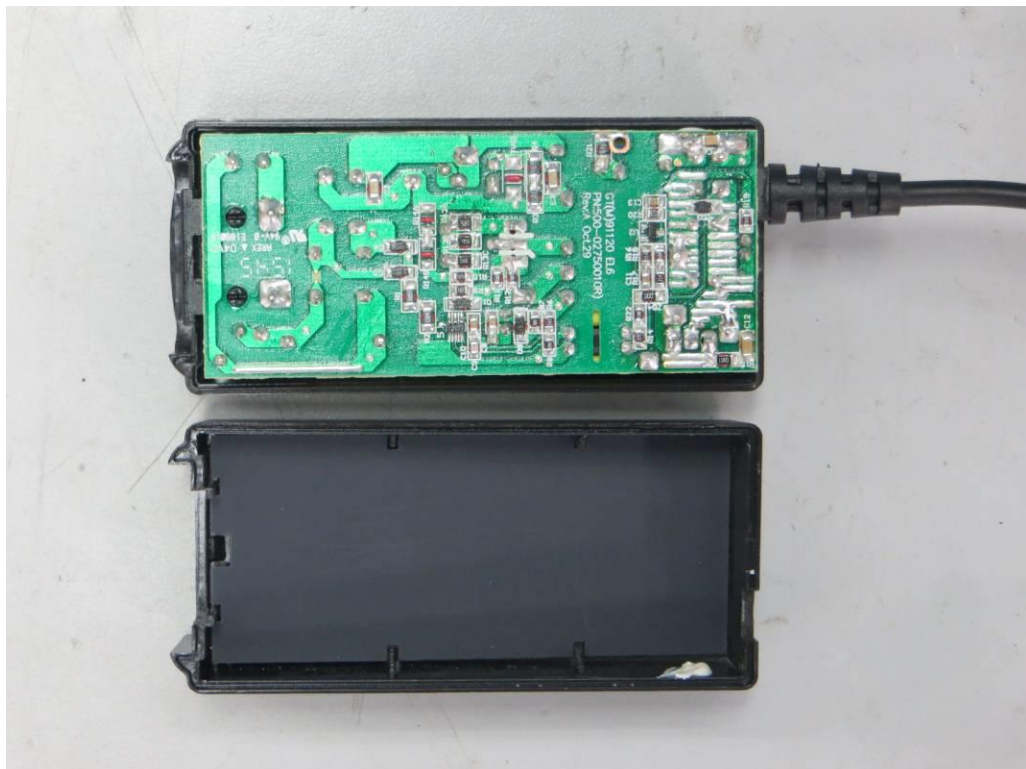

PCB for GTM96300 series (Class II)

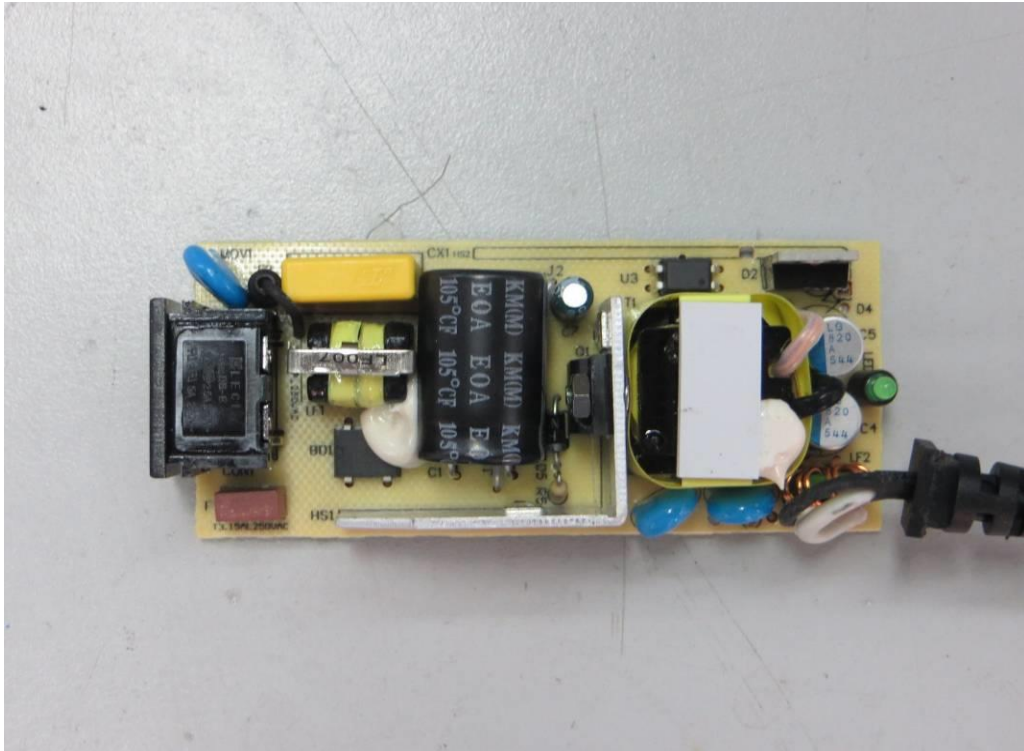

PCB for GTM96300 series (Class II)

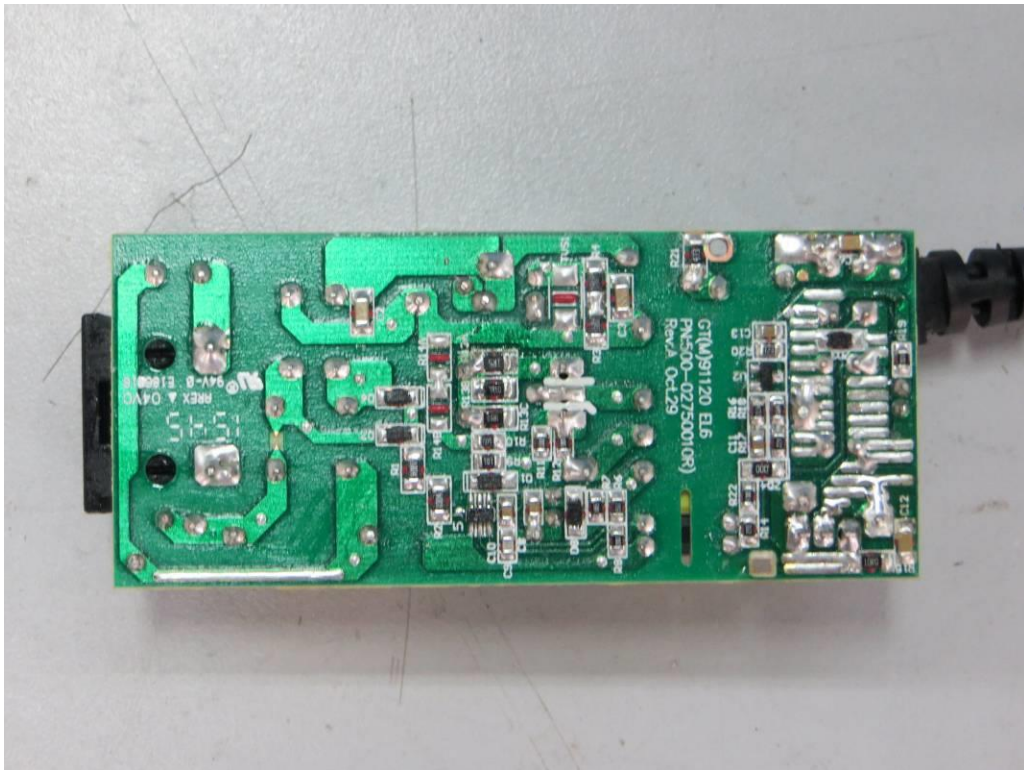

External view for GTM96180 series (desktop)

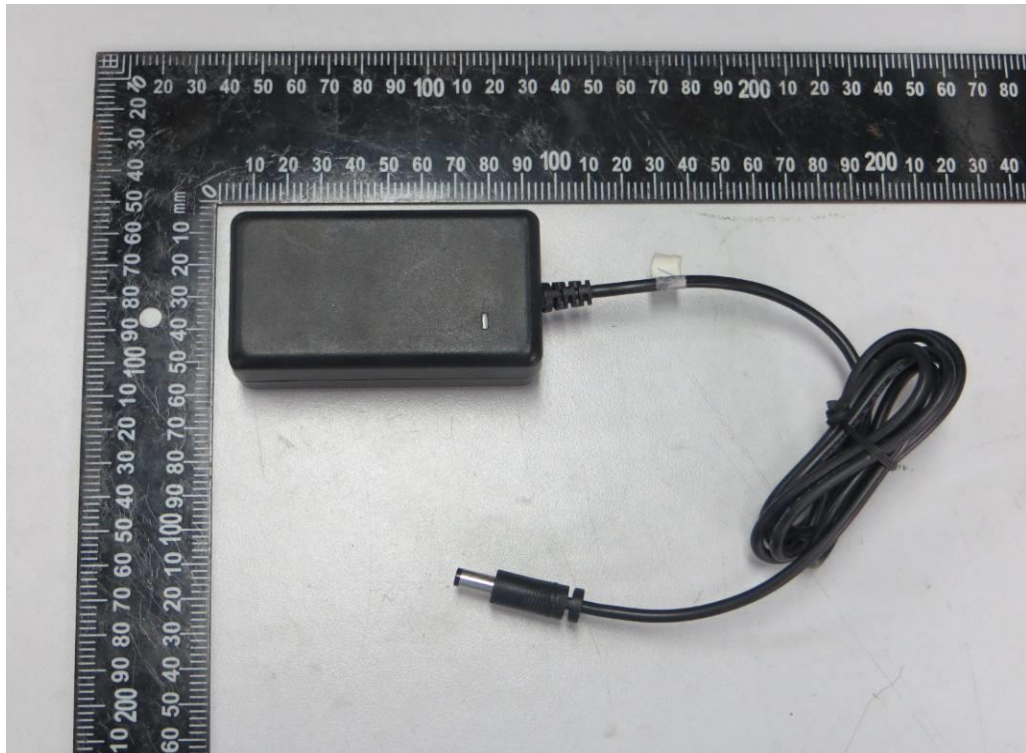

External view for GTM96180 series (desktop)



External view for GTM96180 series (Interchangeable plug)



External view for GTM96180 series (Interchangeable plug)



Internal view for GTM96180 series (Class I)

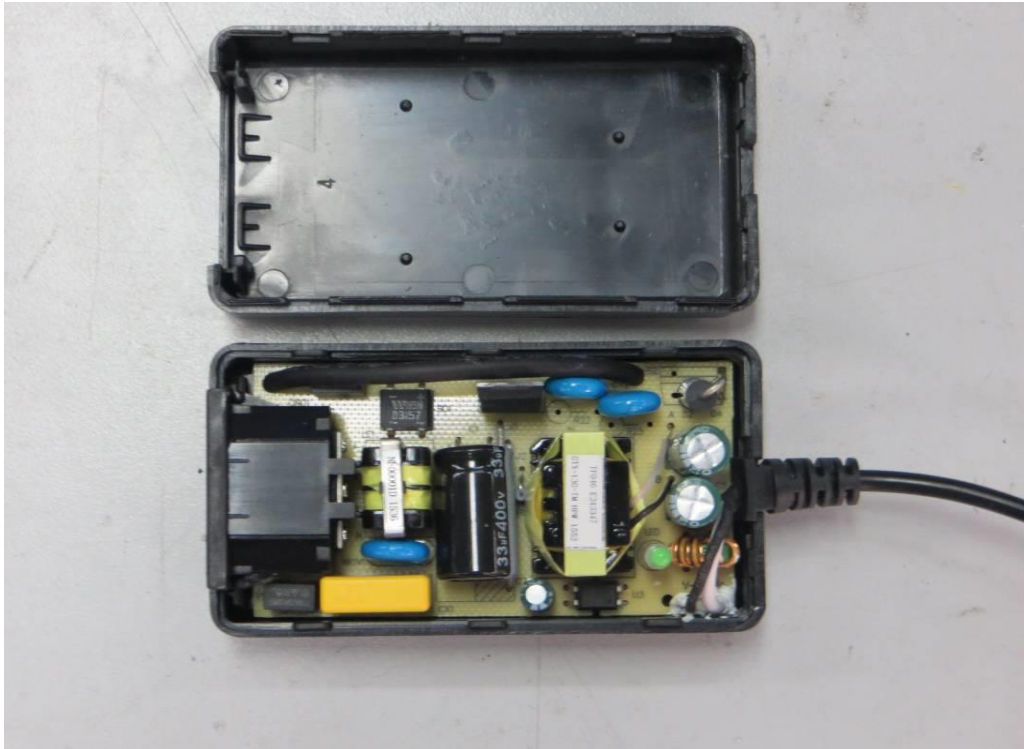

Internal view for GTM96180 series (Class I)



PCB for GTM96180 series (Class I)

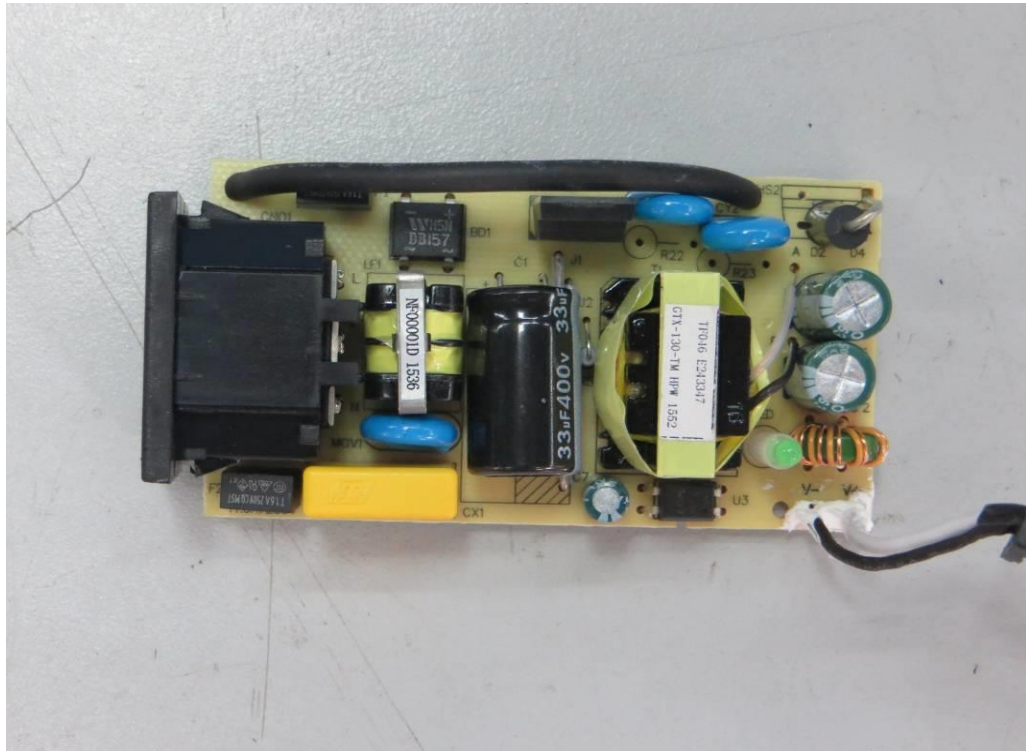

PCB for GTM96180 series (Class I)

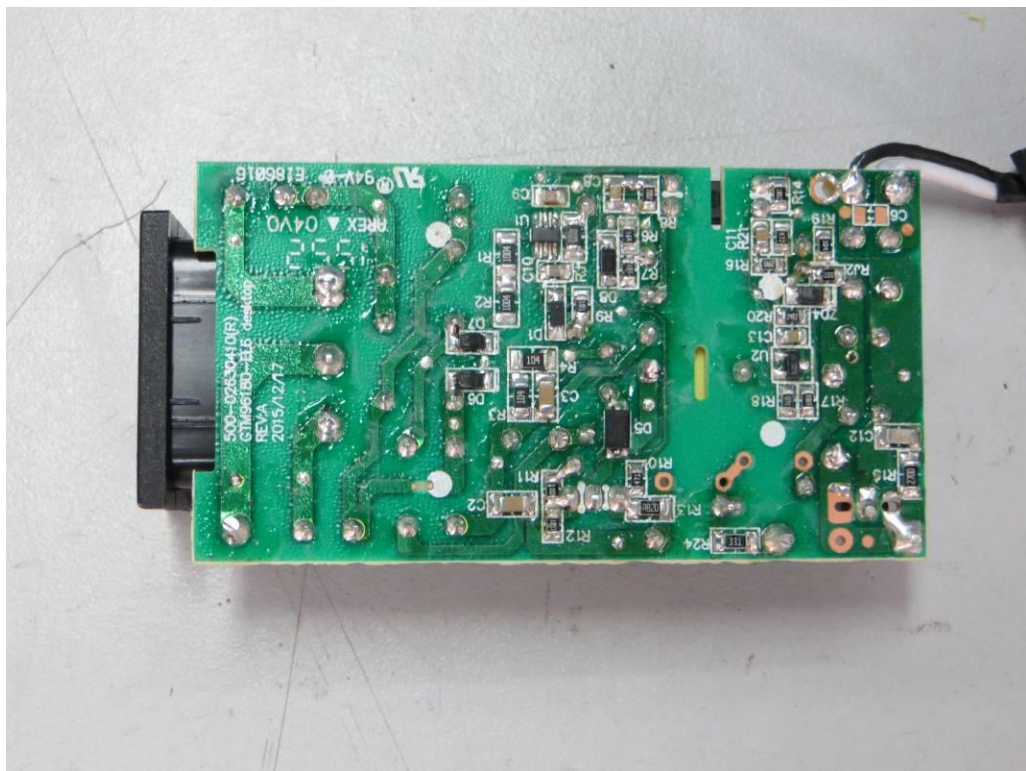

Internal view for GTM96180 series (Class I) with R22, R23 and without R24



PCB view for GTM96180 series (Class I) with R22, R23 and without R24

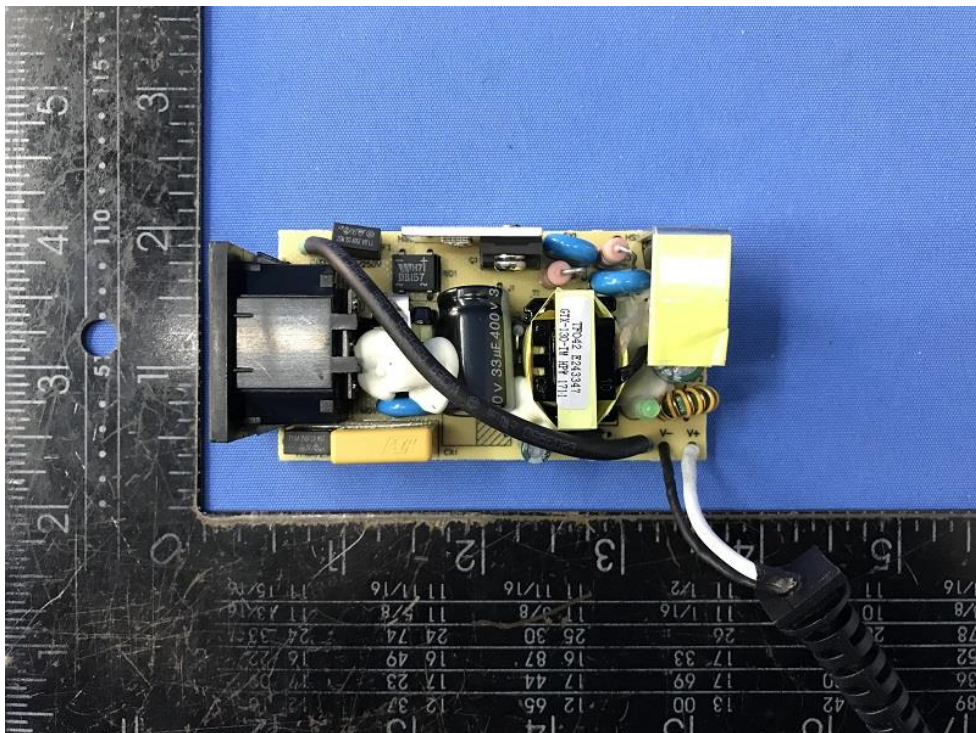

PCB view for GTM96180 series (Class I) with R22, R23 and without R24

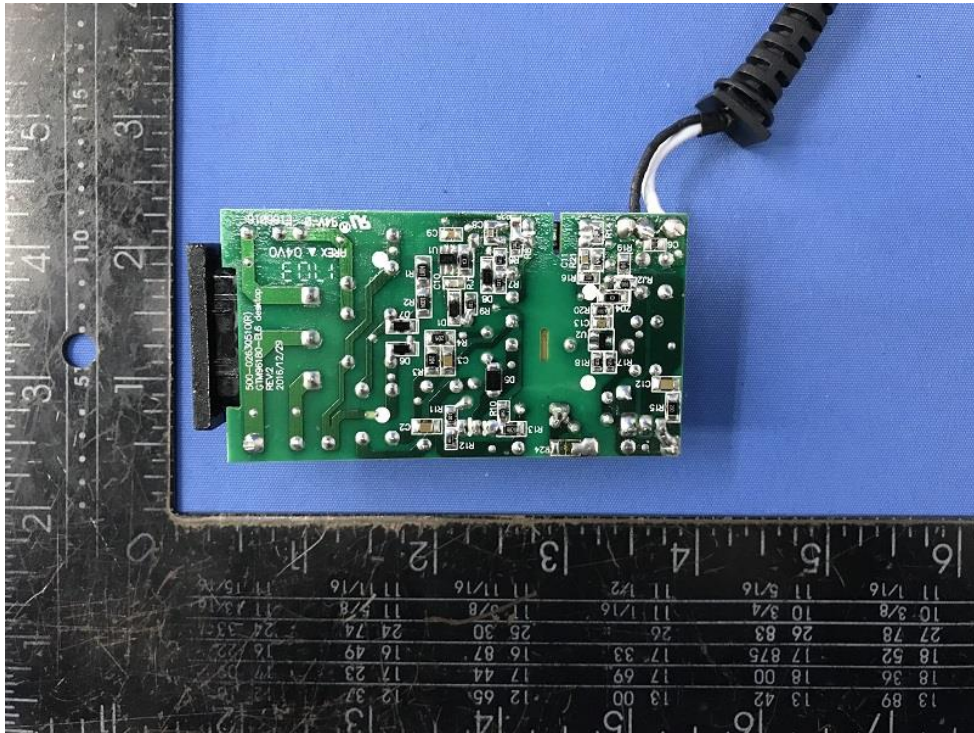

Internal view for GTM96180 series (Class I) without R22, R23 and with R24

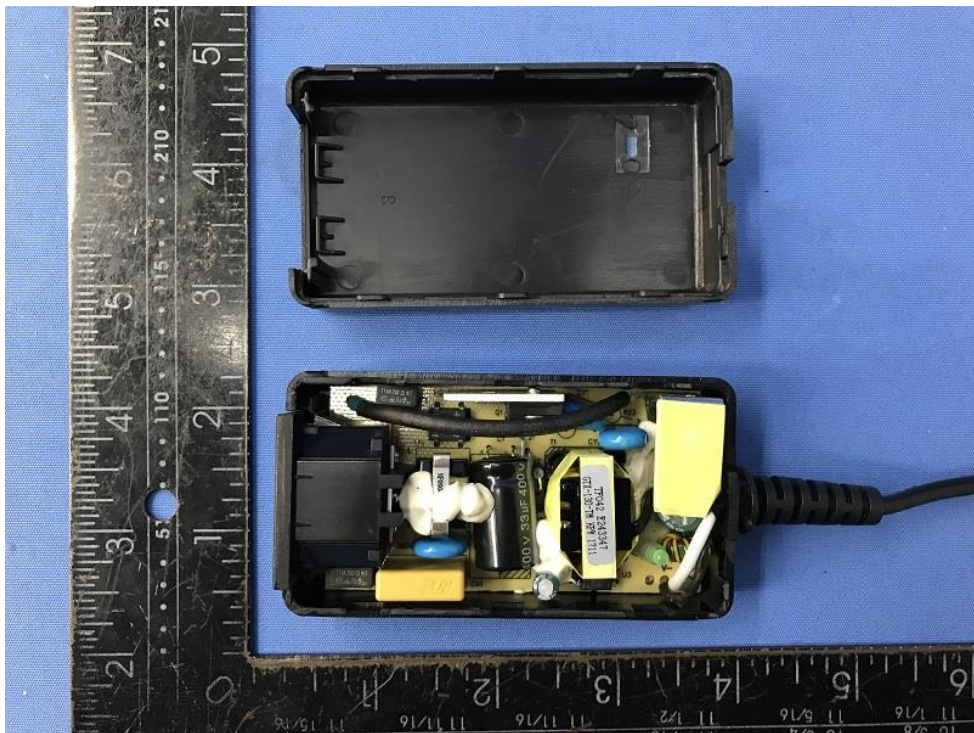

PCB view for GTM96180 series (Class I) without R22, R23 and with R24

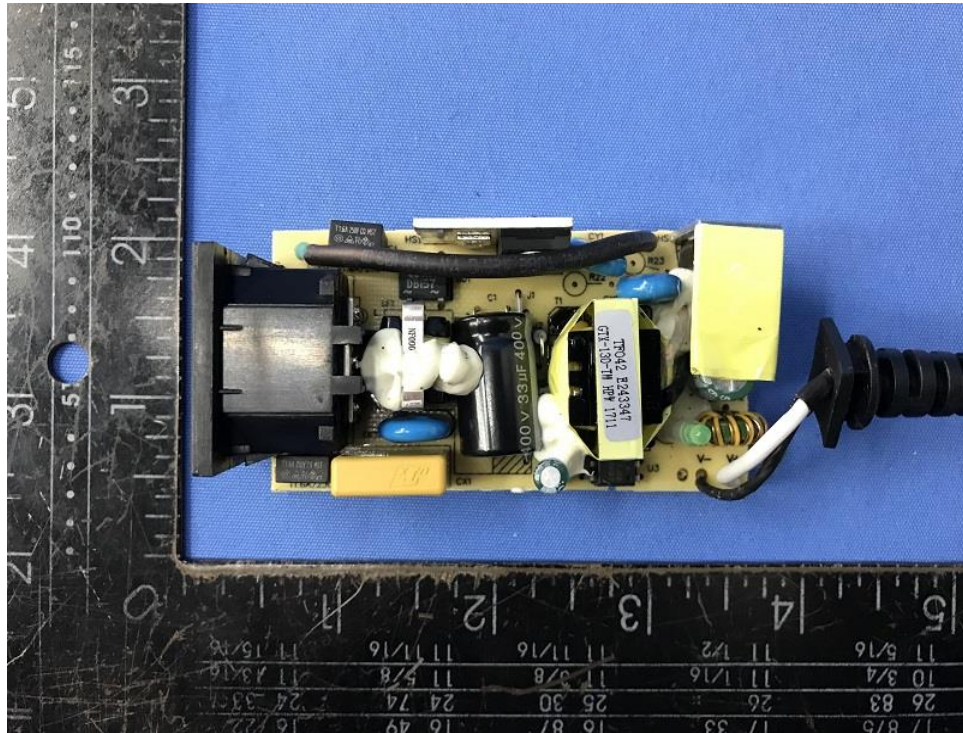

PCB view for GTM96180 series (Class I) without R22, R23 and with R24

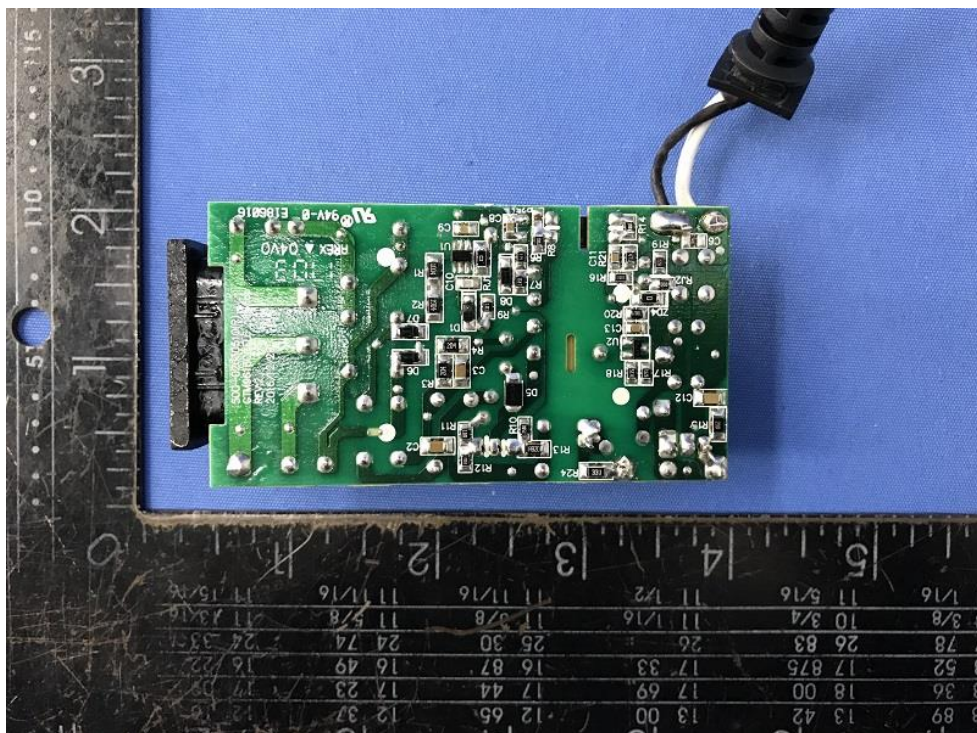

Internal view for GTM96180 series (Class I) without R22, R23 and with R24

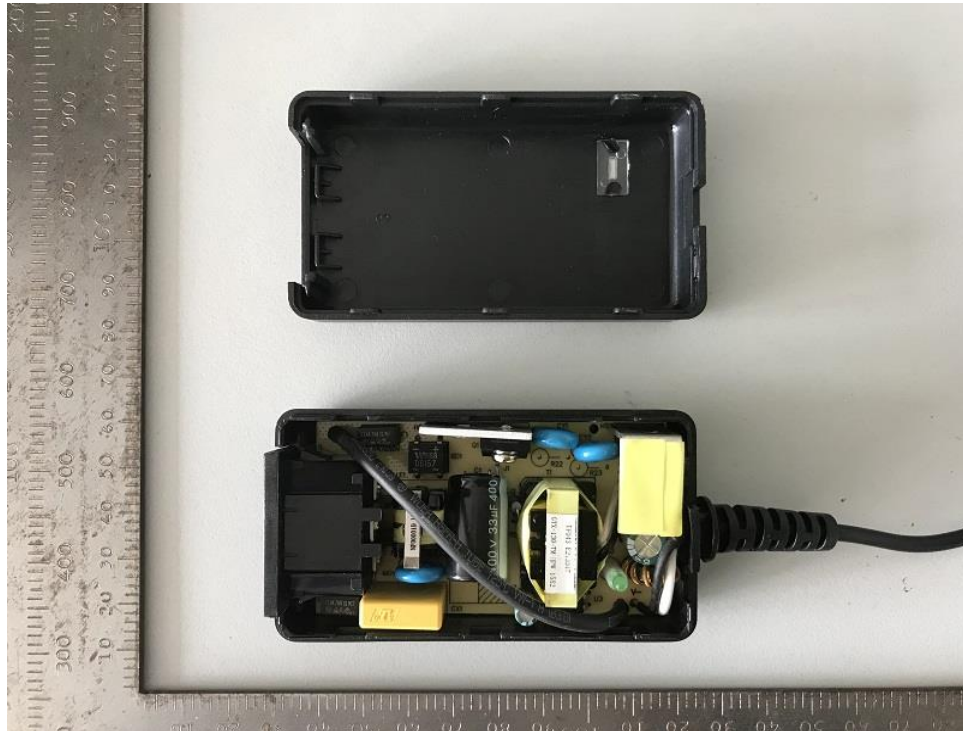

PCB view for GTM96180 series (Class I) without R22, R23 and with R24

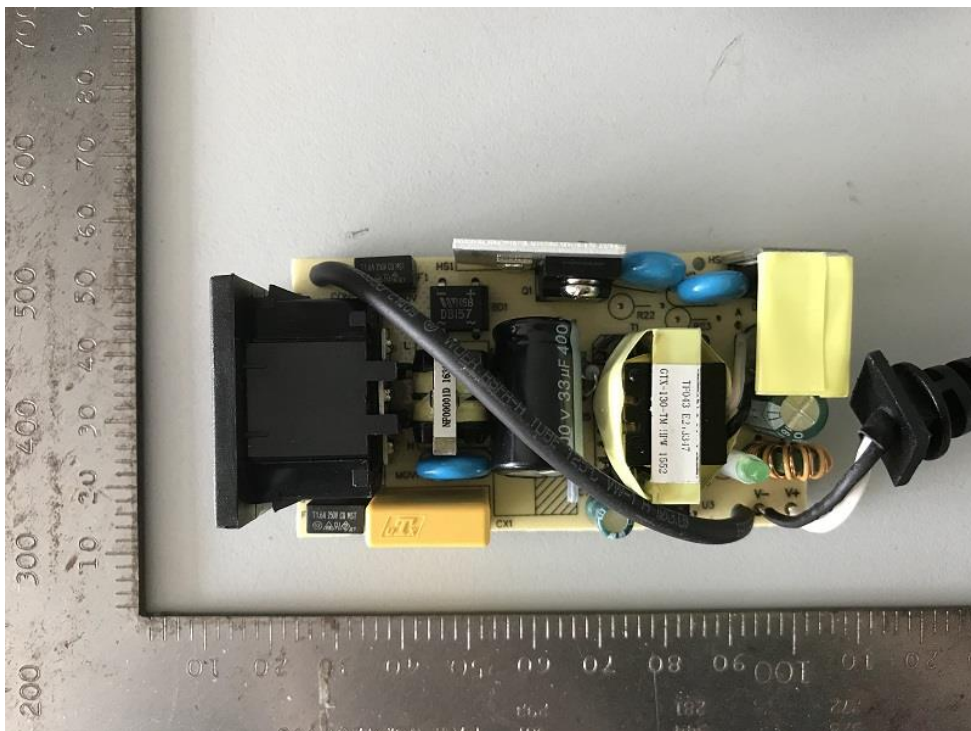

PCB view for GTM96180 series (Class I) without R22, R23 and with R24

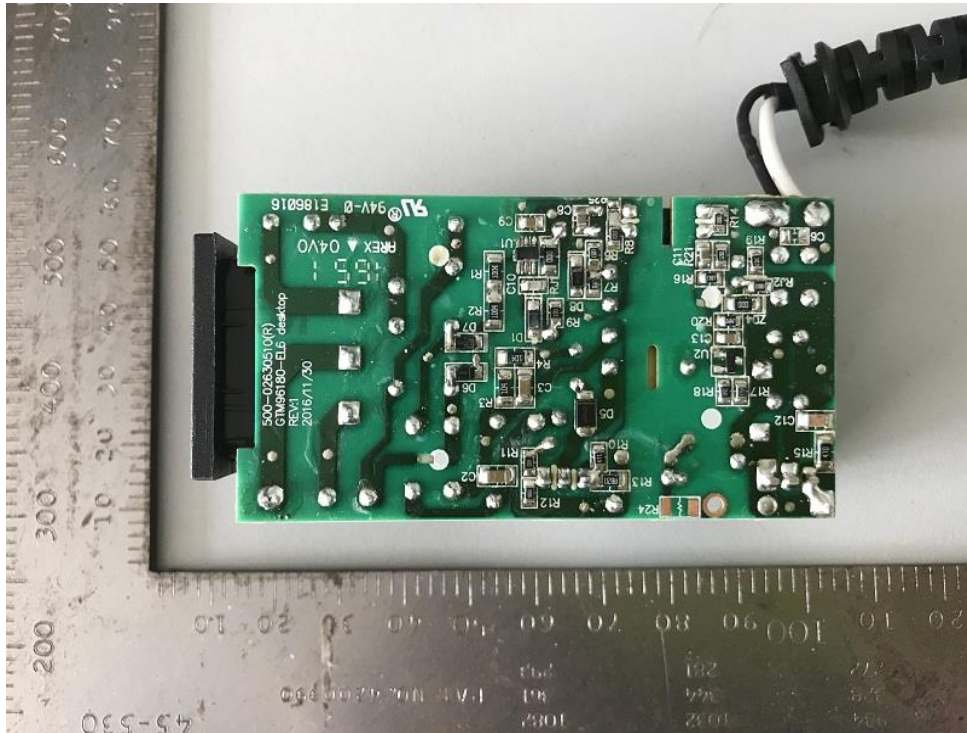

Internal view for GTM96180 series (Class I) without heatsink for D2



PCB view for GTM96180 series (Class I) without heatsink for D2

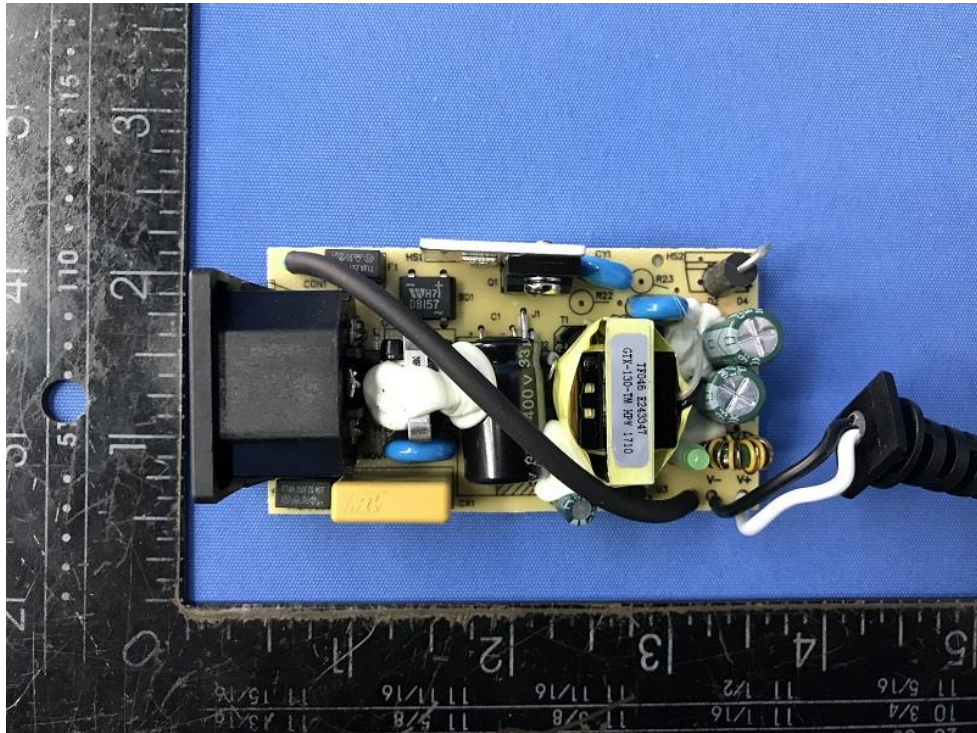

PCB view for GTM96180 series (Class I) without heatsink for D2

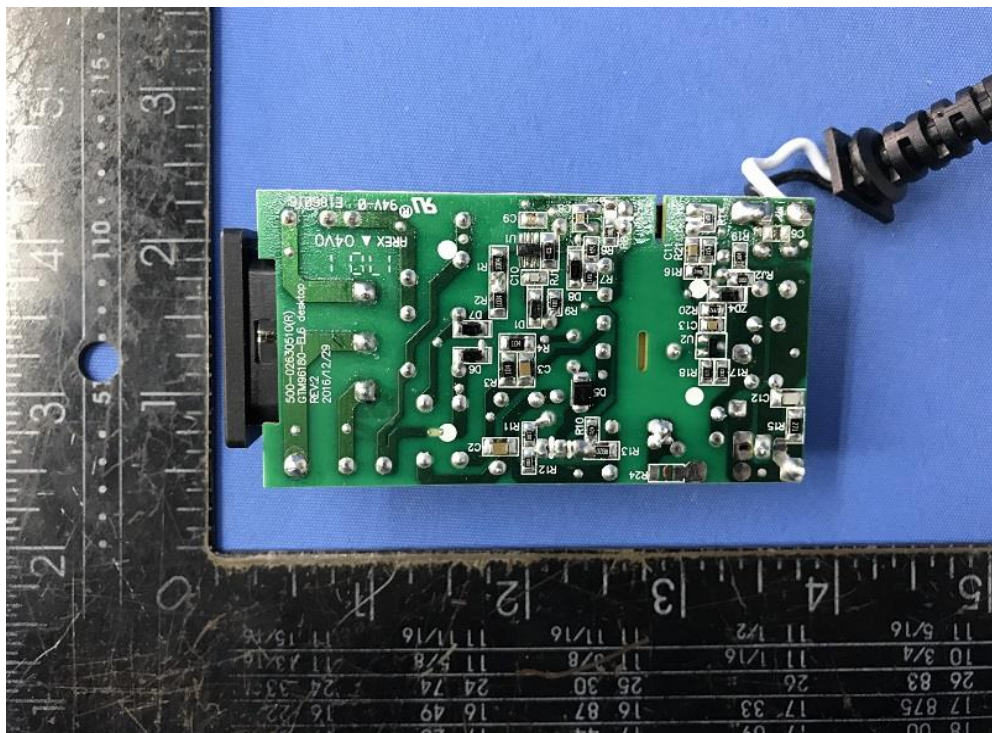

Internal view for GTM96180 series (Interchangeable plug)

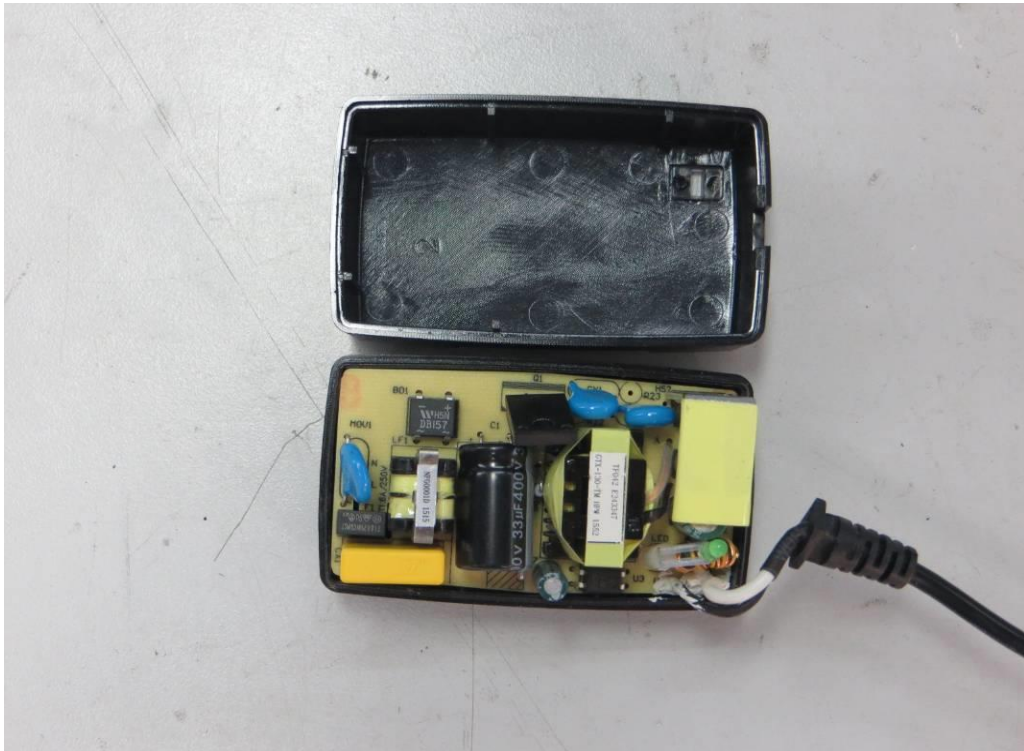

Internal view for GTM96180 series (Interchangeable plug)



PCB for GTM96180 series (Interchangeable plug)

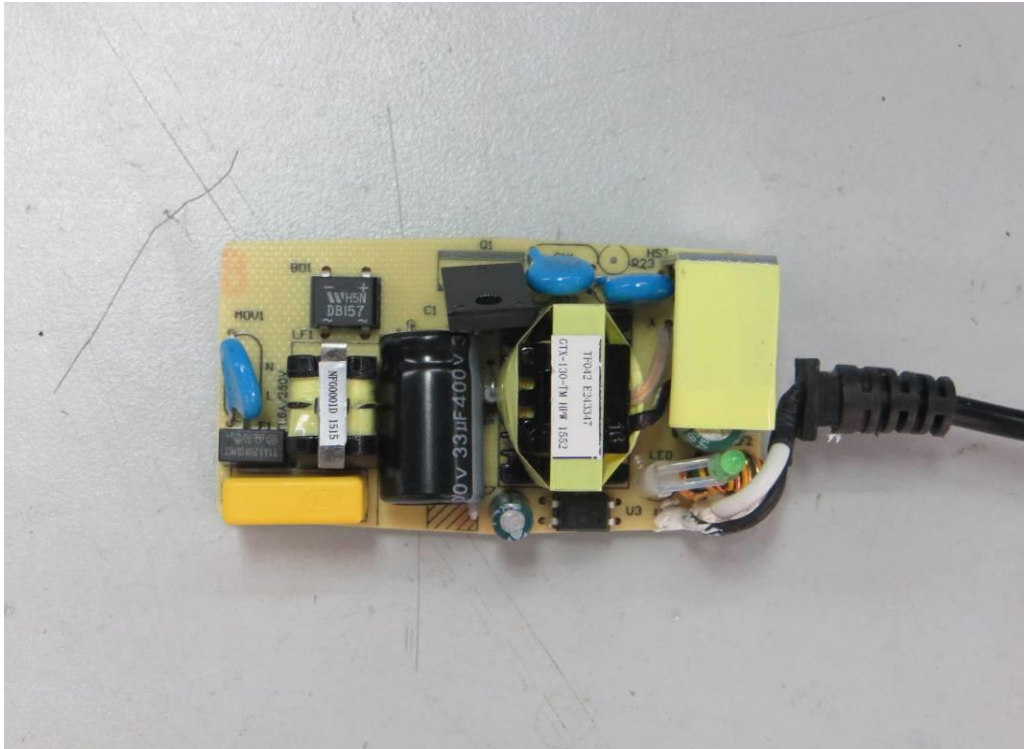

PCB for GTM96180 series (Interchangeable plug)

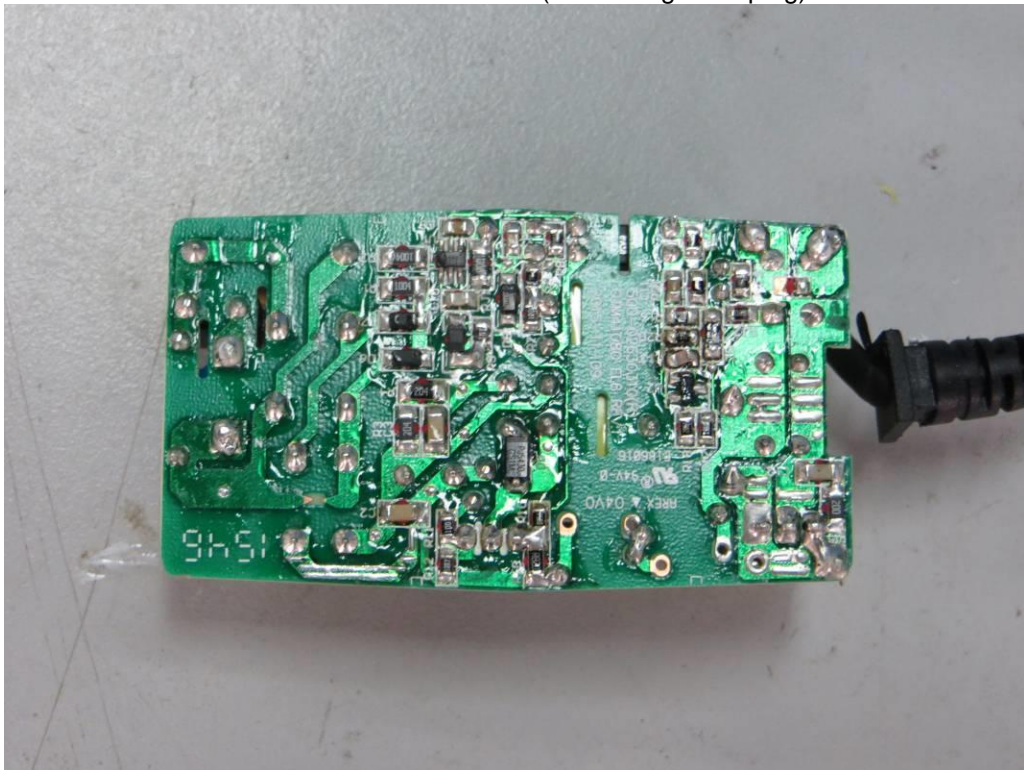

External view for GTM91120 series



External view for GTM91120 series



External view for GTM91120 series



External view for GTM91120 series



Internal view for GTM91120 series



Internal view for GTM91120 series

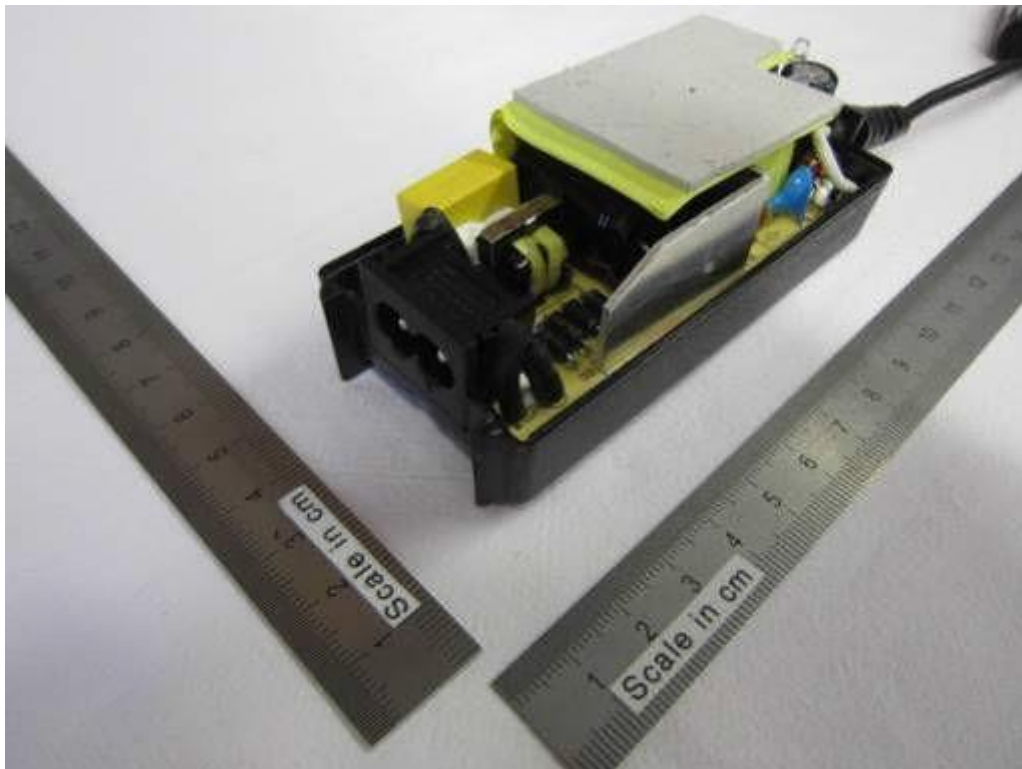

Internal view for GTM91120 series

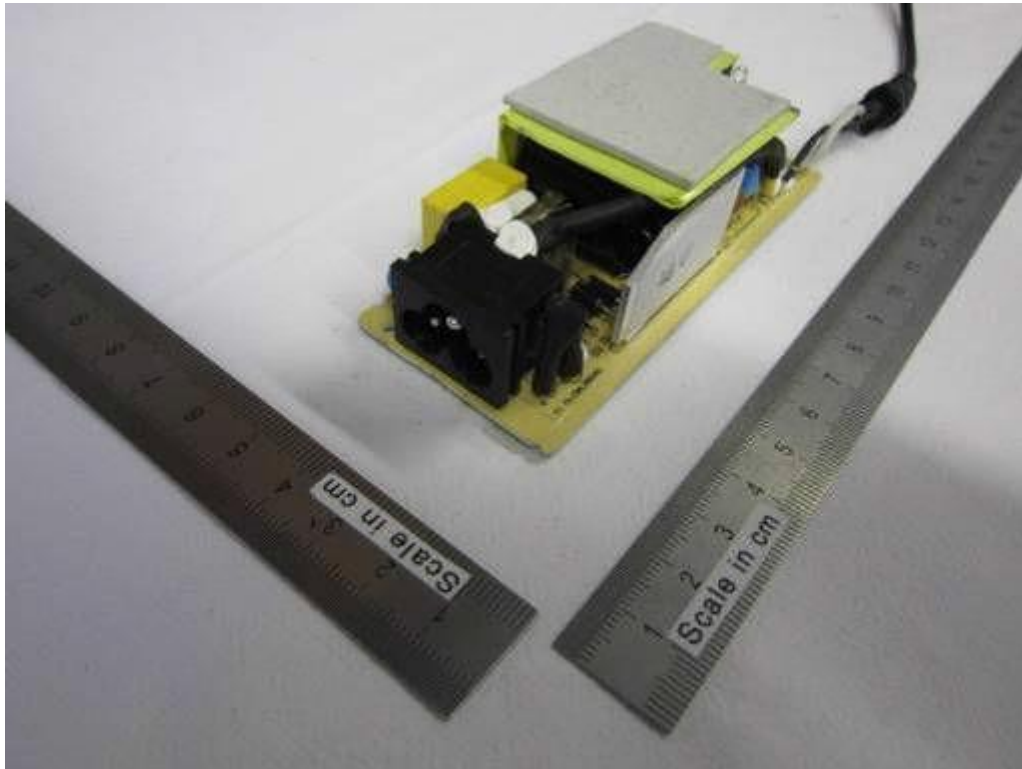

Internal view for GTM91120 series

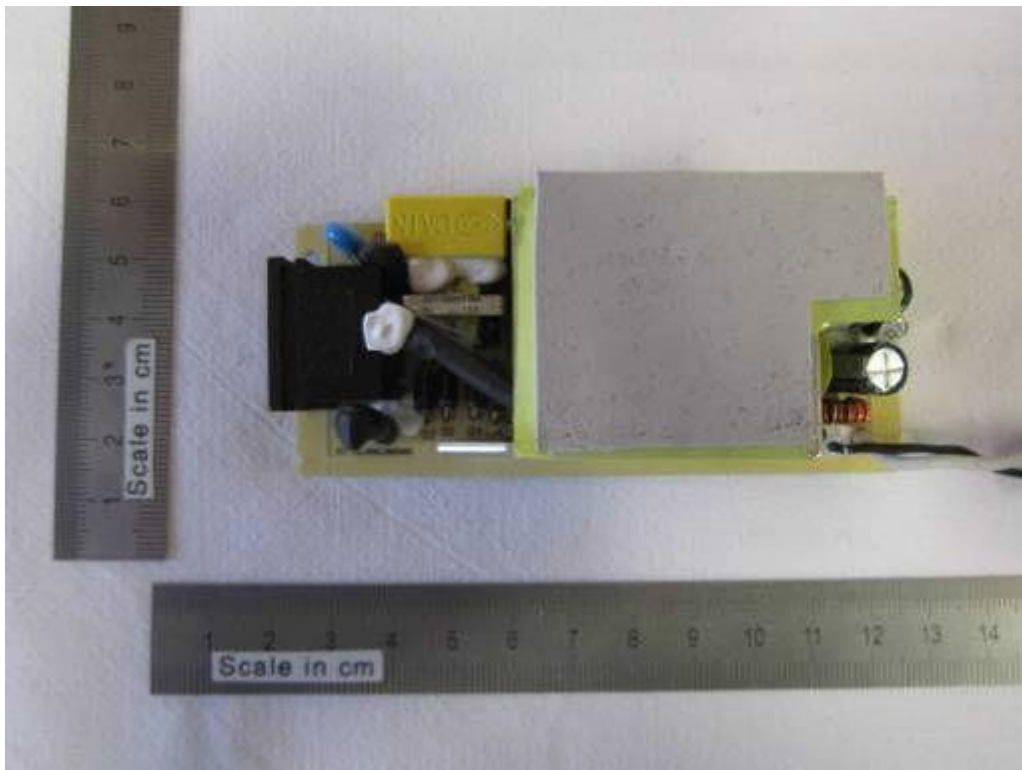

Internal view for GTM91120 series

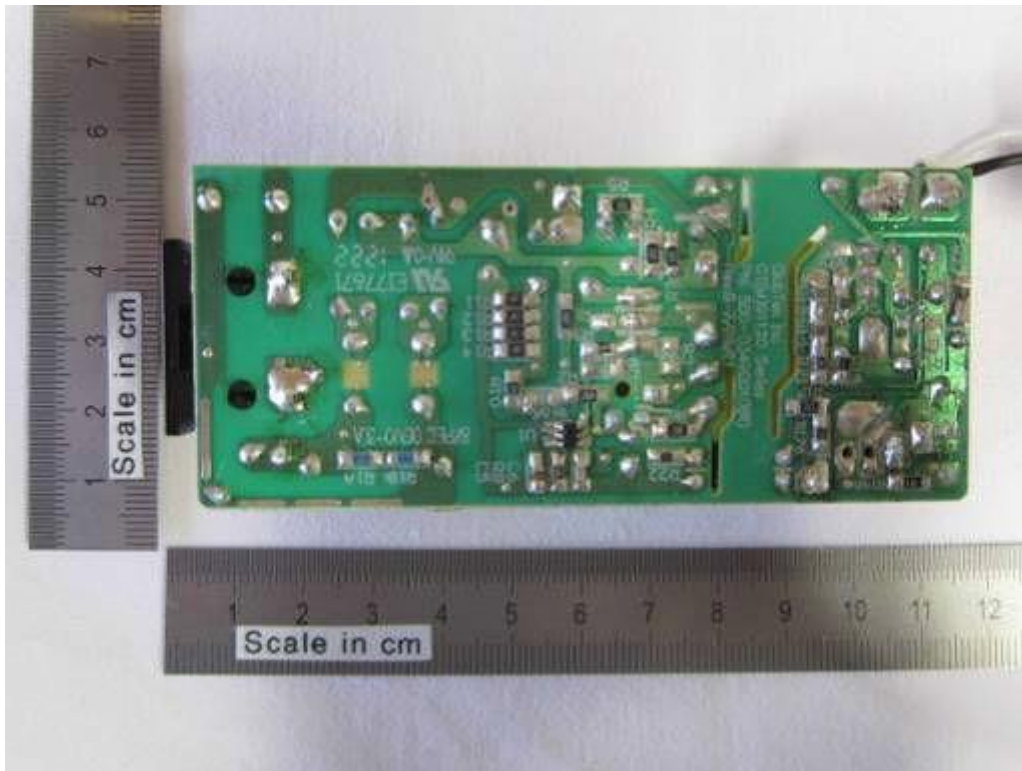

External view for GTM91120 series (Encapsulated)



External view for GTM91120 series (Encapsulated)



Internal view for GTM91120 series (Encapsulated)

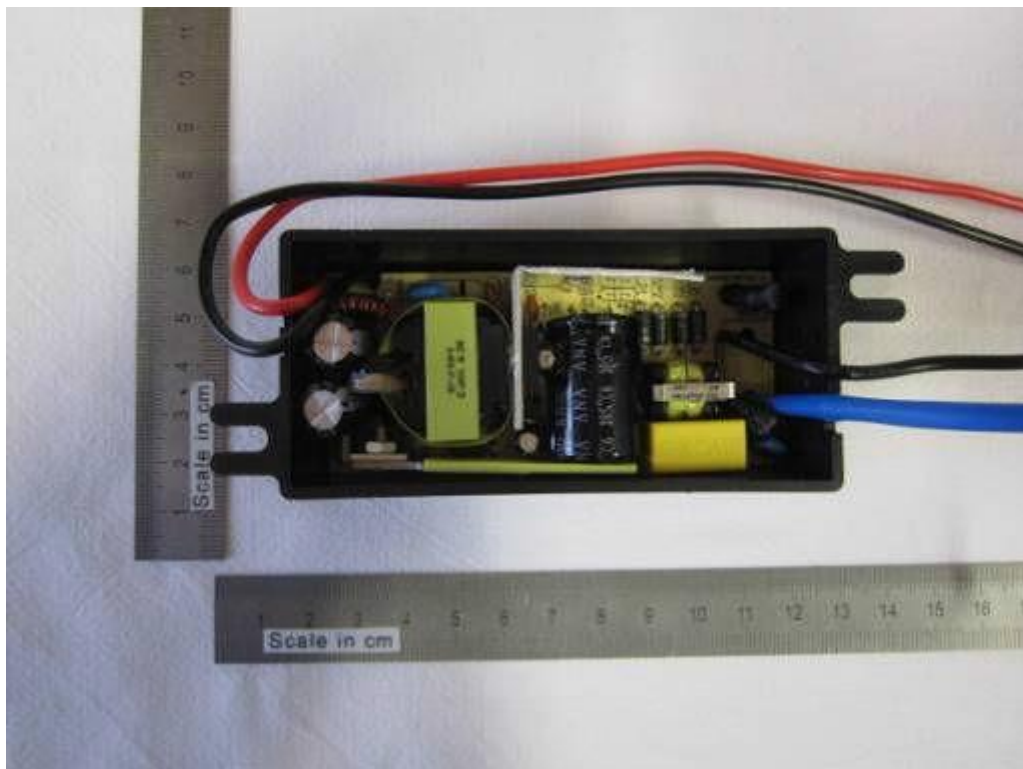

Internal view for GTM91120 series (Encapsulated)

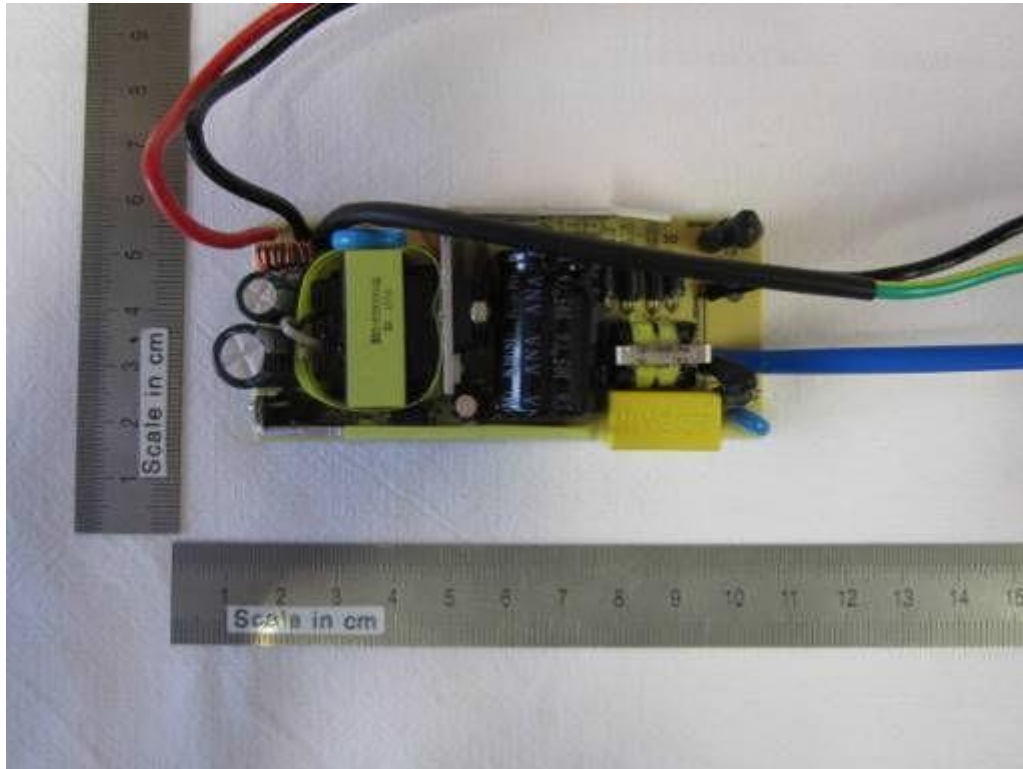

Internal view for GTM91120 series (Encapsulated)

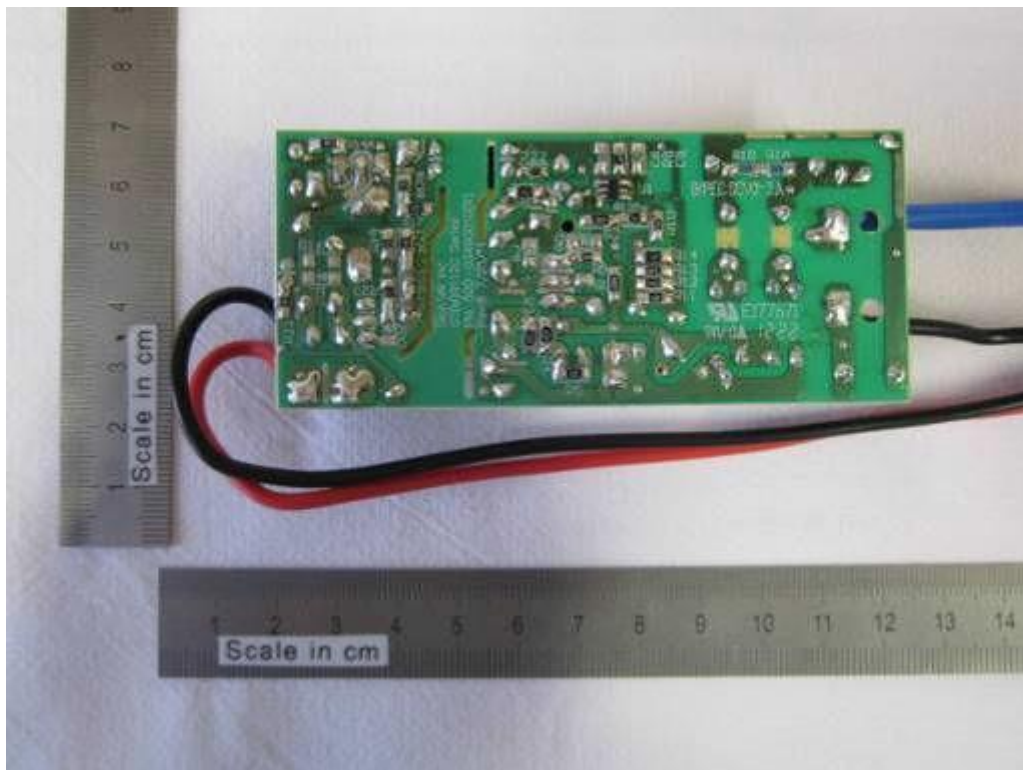

External view for GTM91120 series (Open frame)

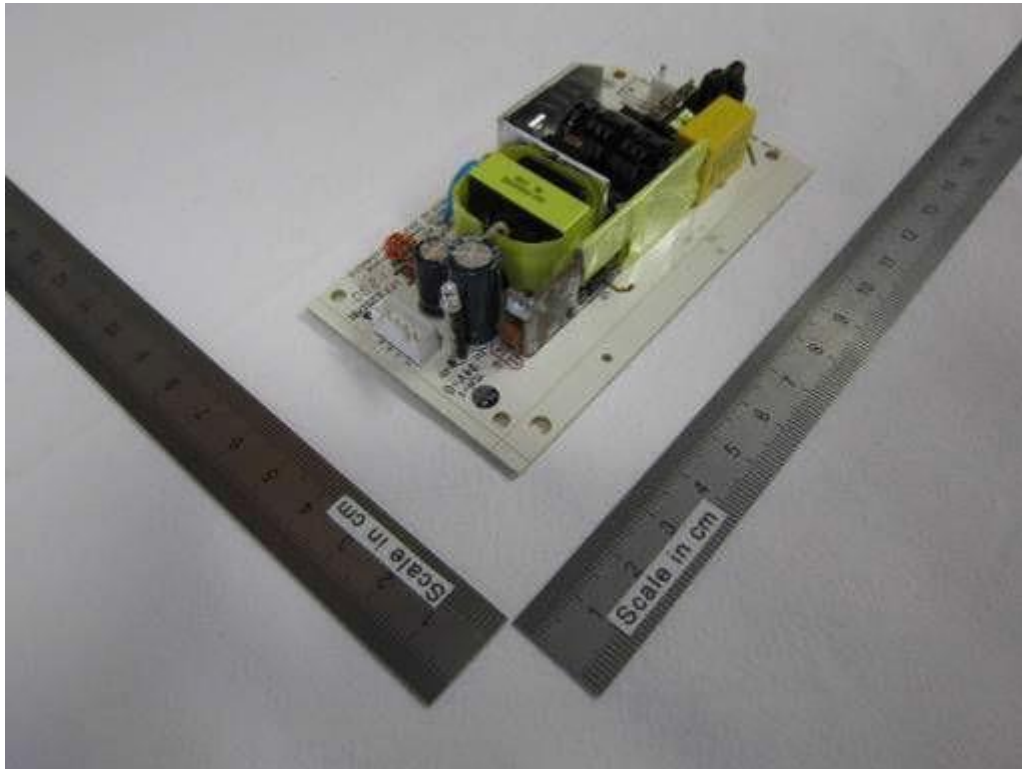

External view for GTM91120 series (Open frame)

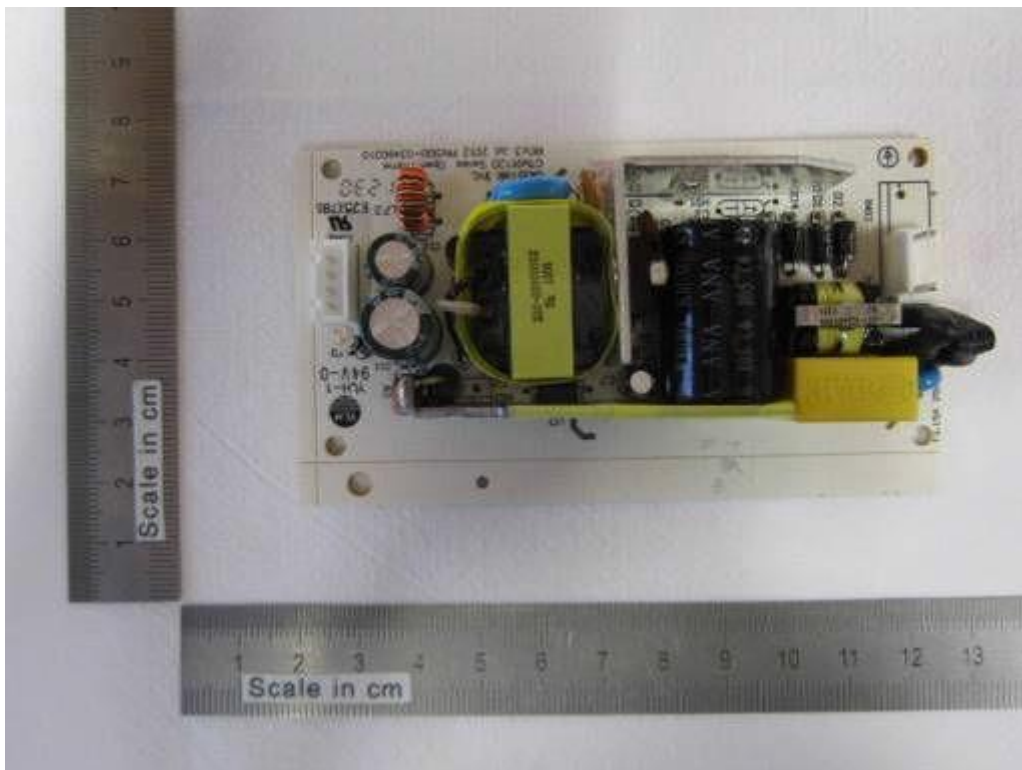

External view for GTM91120 series (Open frame)

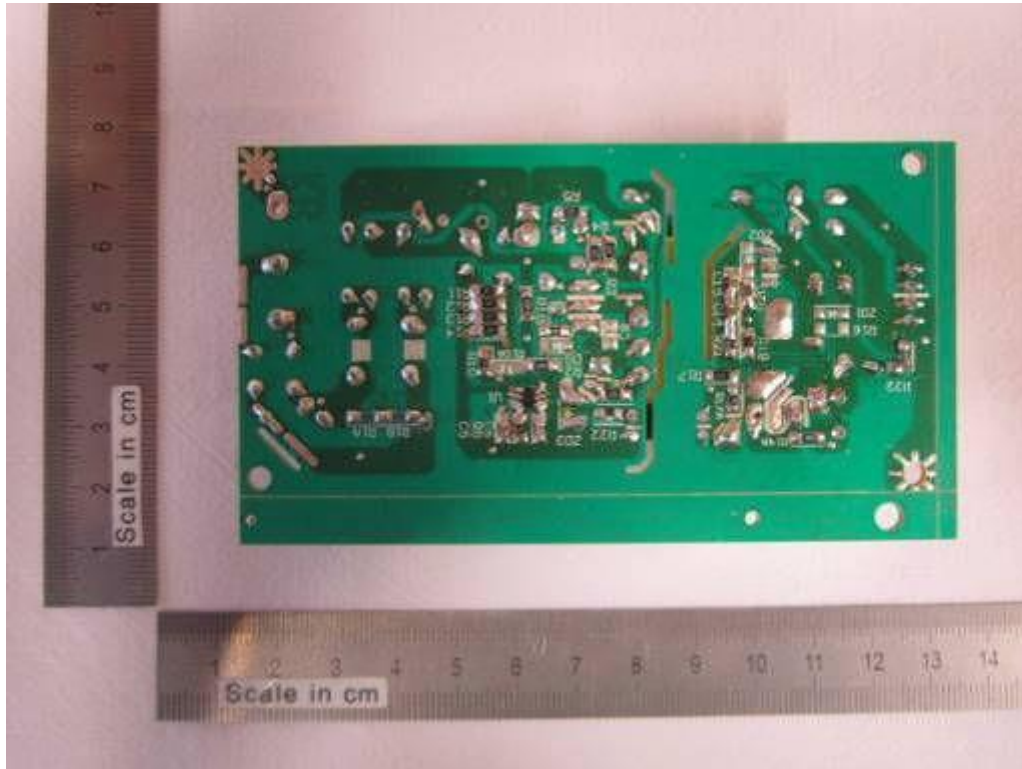

External view for GTM91128LI1CELL, GTM91128LI2CELL, GTM91128LI3CELL



External view for GTM91128LI1CELL, GTM91128LI2CELL, GTM91128LI3CELL



External view for GTM91128LI1CELL, GTM91128LI2CELL, GTM91128LI3CELL



PCB for GTM91128LI1CELL, GTM91128LI2CELL, GTM91128LI3CELL

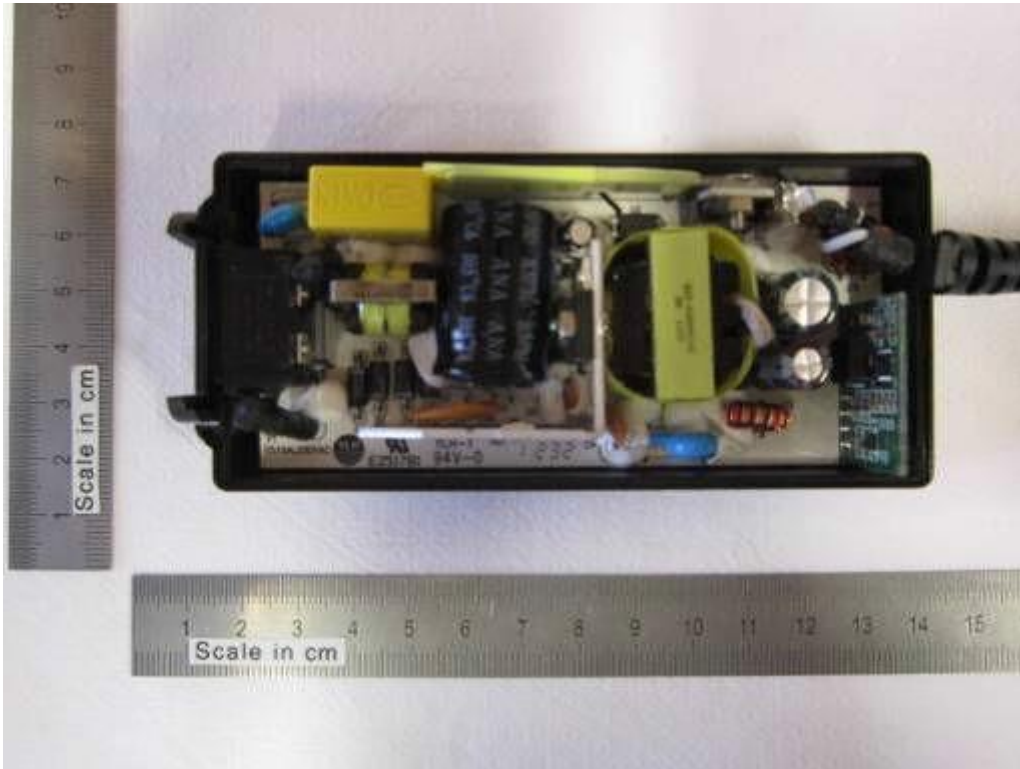

PCB for GTM91128LI1CELL, GTM91128LI2CELL, GTM91128LI3CELL

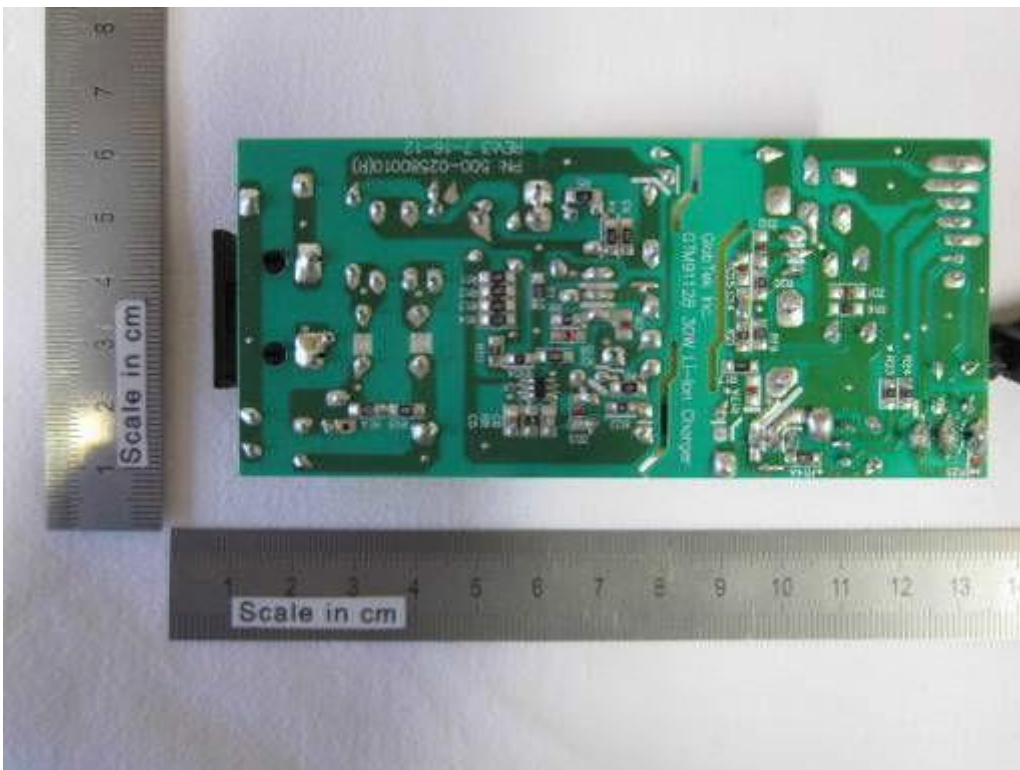

External view for POE series

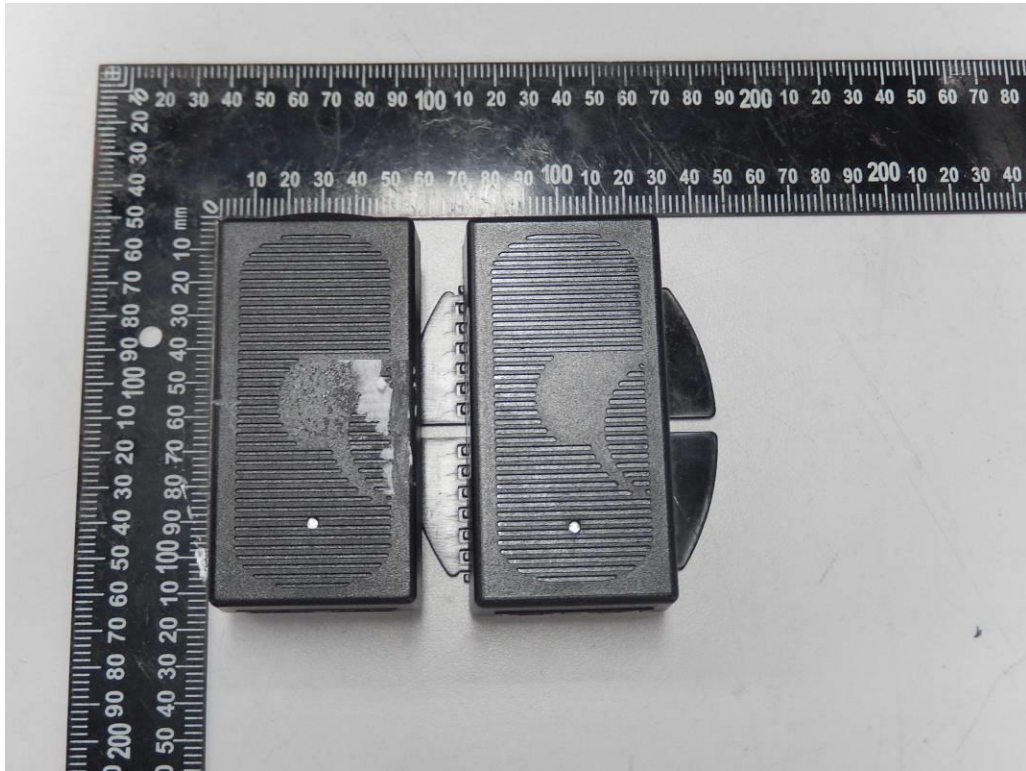

External view for POE series

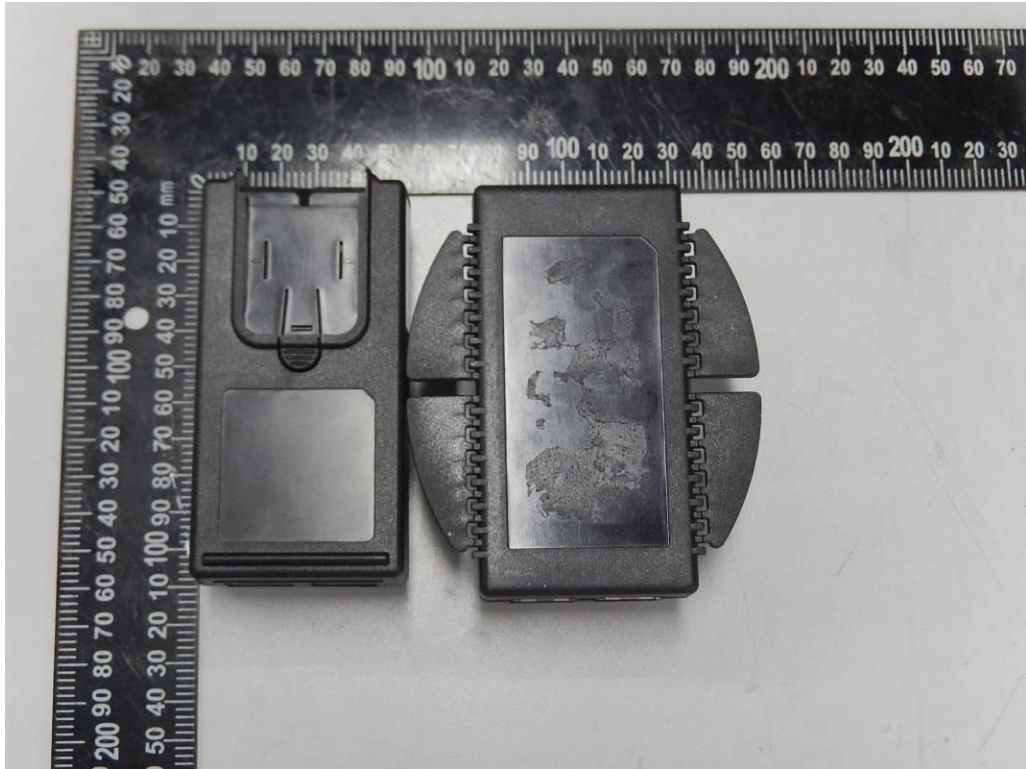

Internal view for POE series

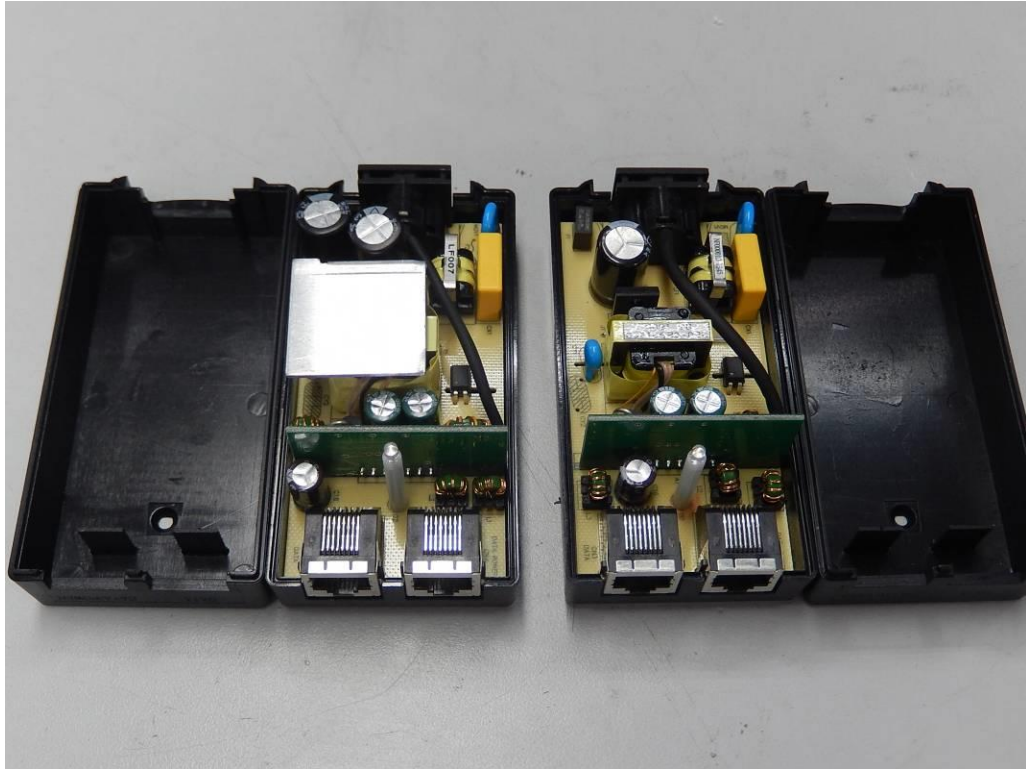

Internal view for POE series

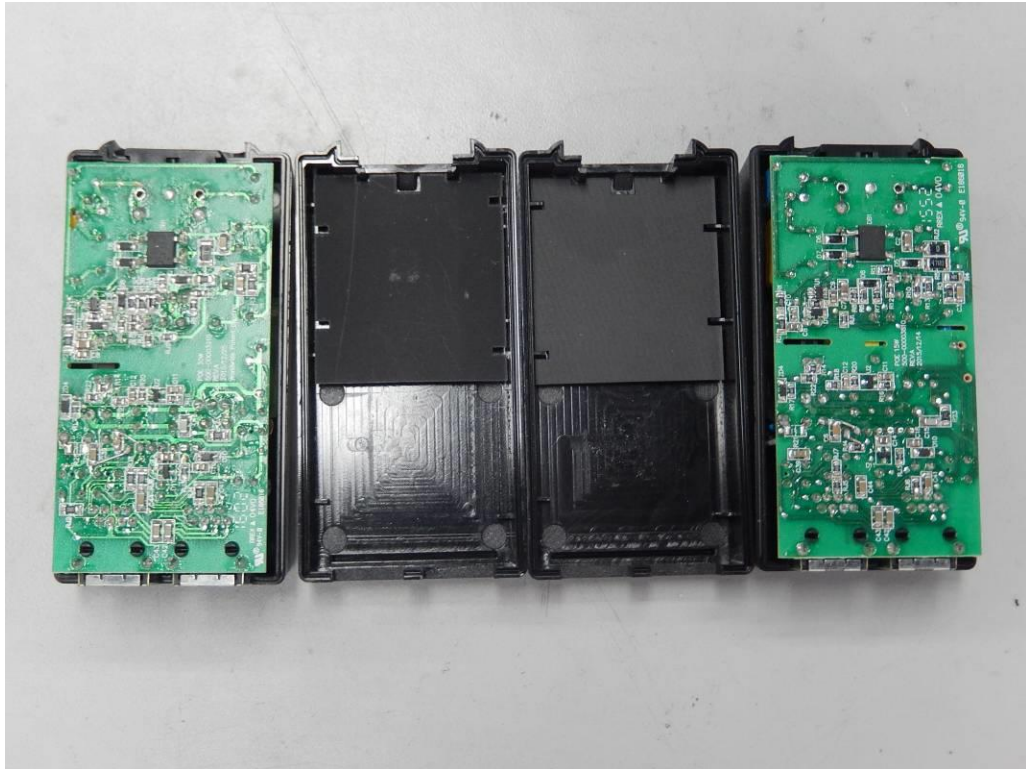

PCB for POE series

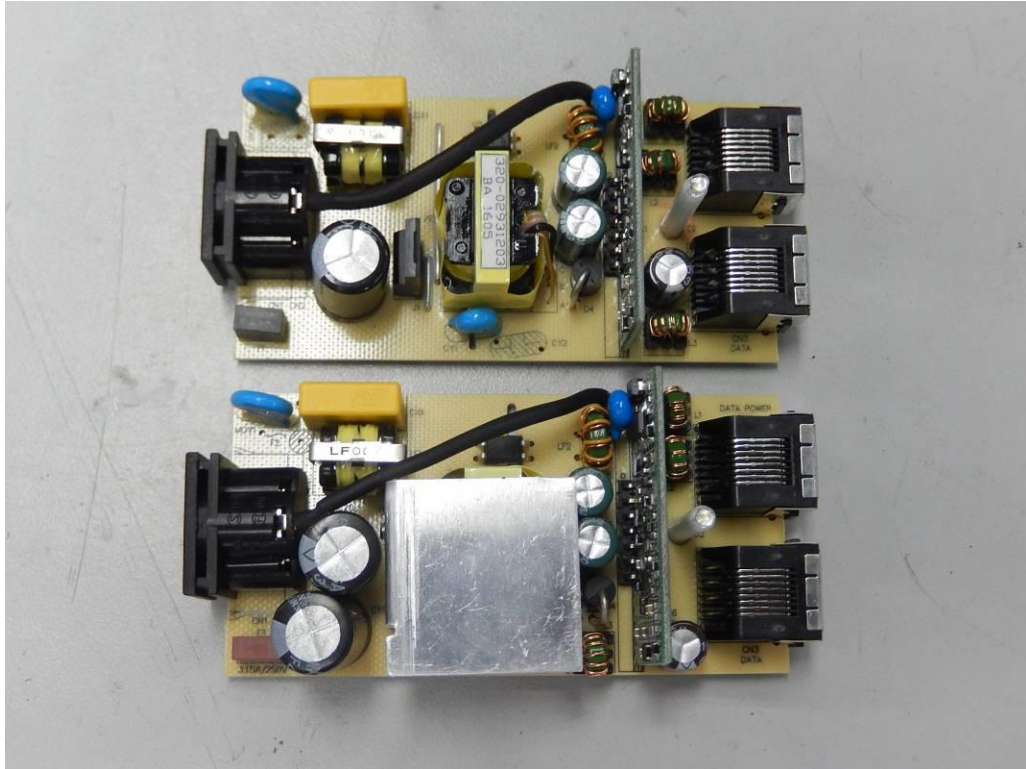

PCB for POE series

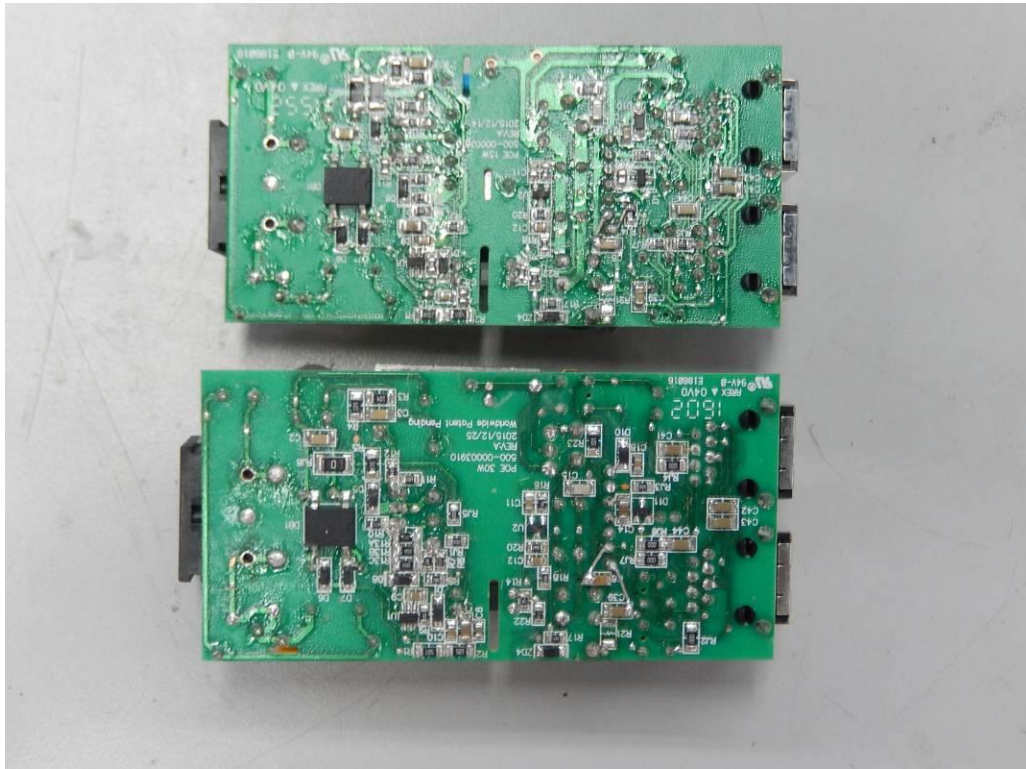

External view for model GTM96180-1830-12.0



External view for model GTM96180-1830-12.0

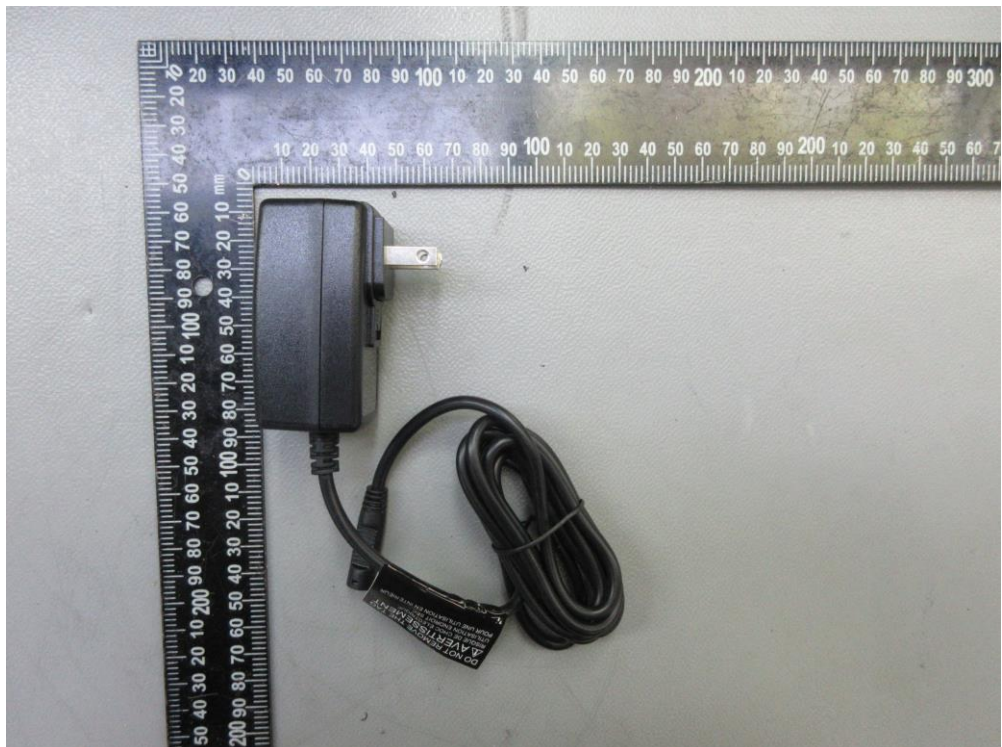

External view for GTM91128LI3CEL-**** or GTM91128*CHRG-****



External view for GTM91128LI3CEL-**** or GTM91128*CHRG-****



Internal view for GTM91128LI3CEL-**** or GTM91128*CHARGE-****

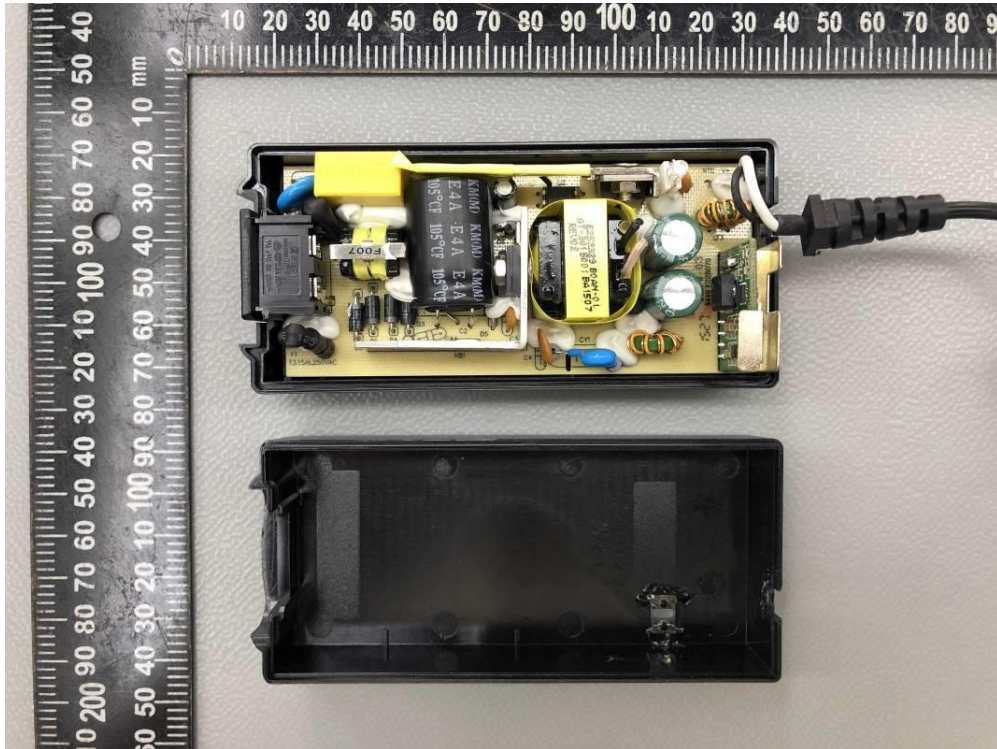

Internal view for GTM91128LI3CEL-**** or GTM91128*CHARGE-****

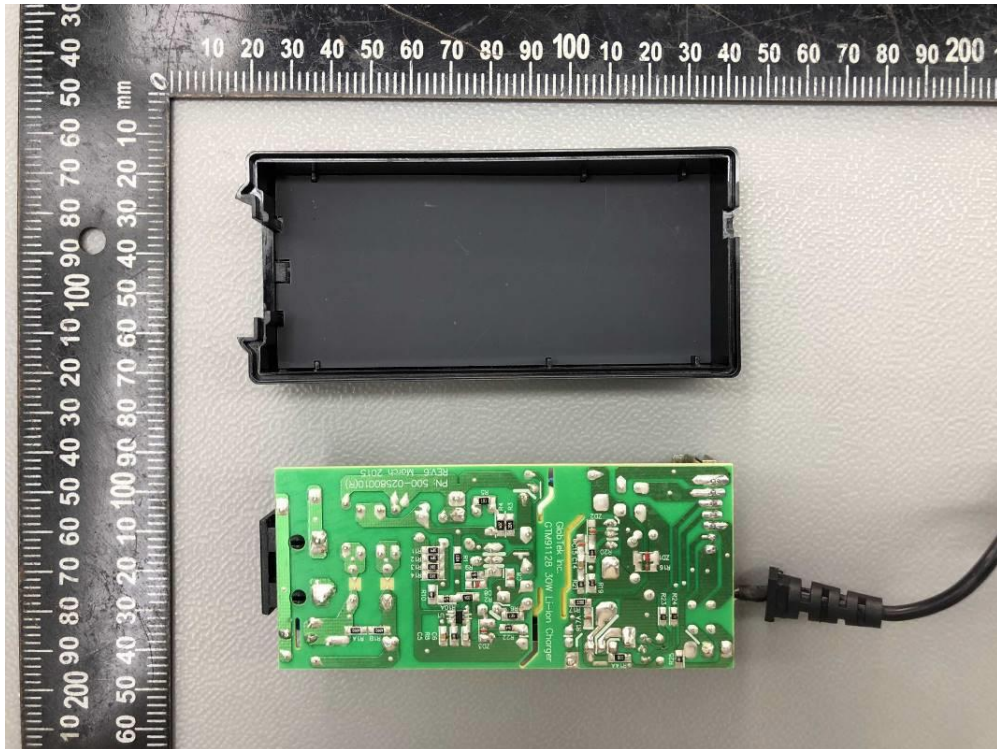

PCB view for GTM91128LI3CEL-**** or GTM91128*CHRG-****

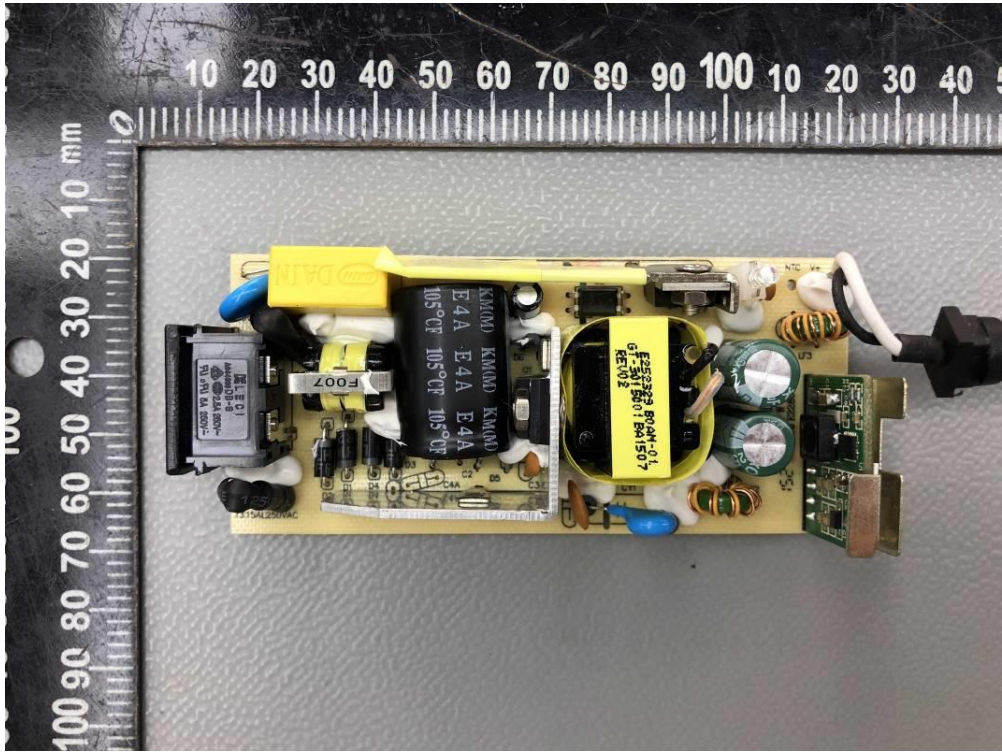

PCB view for GTM91128LI3CEL-**** or GTM91128*CHRG-****

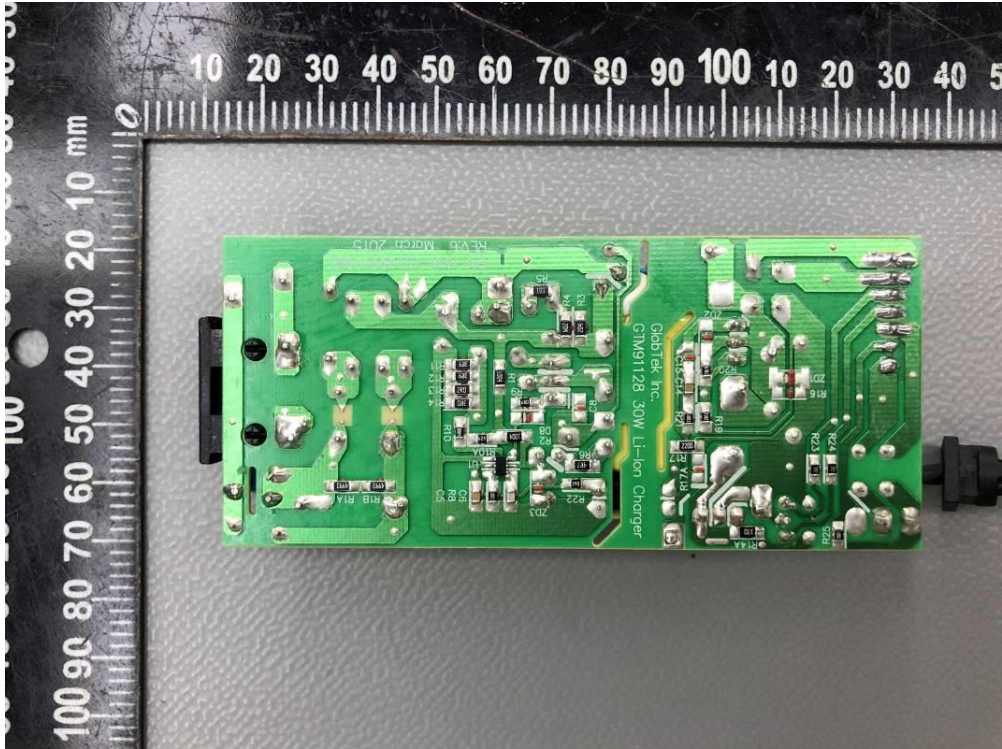

External view for GTM91128LI3CEL-****



External view for GTM91128LI3CEL-****



Internal view for GTM91128LI3CEL-****

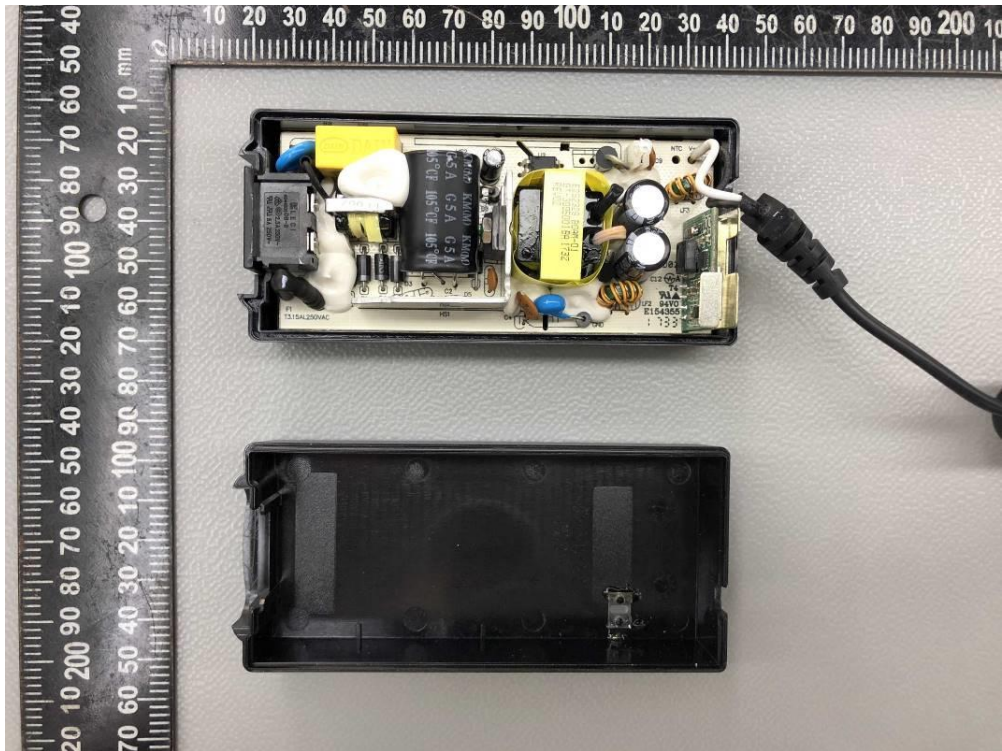

Internal view for GTM91128LI3CEL-****

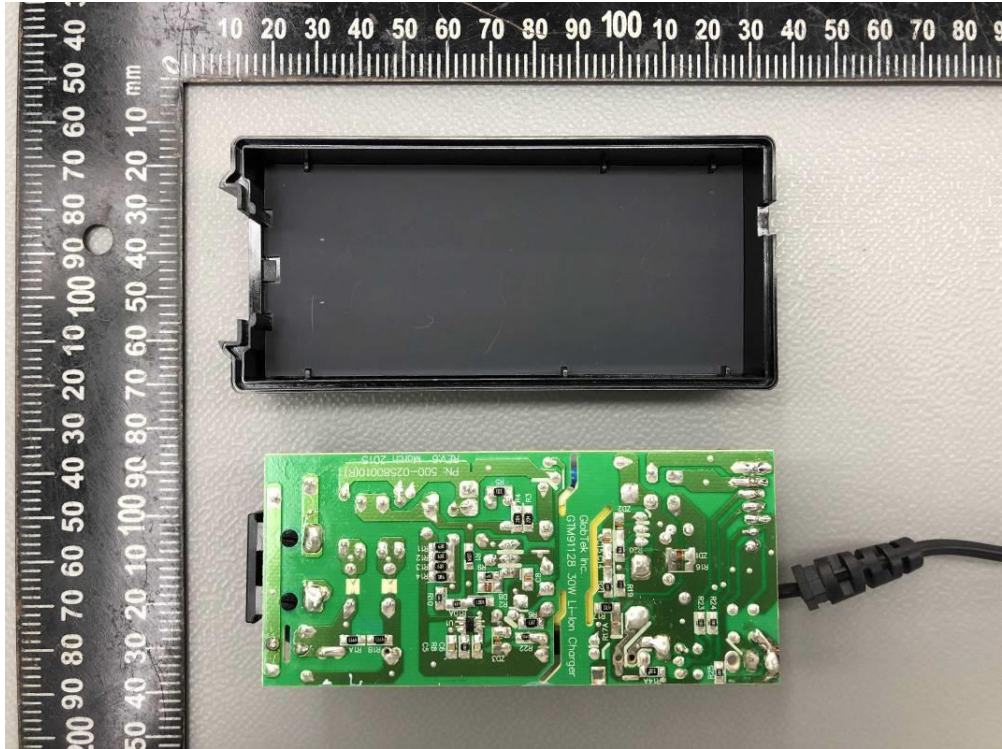

PCB view for GTM91128LI3CEL-****

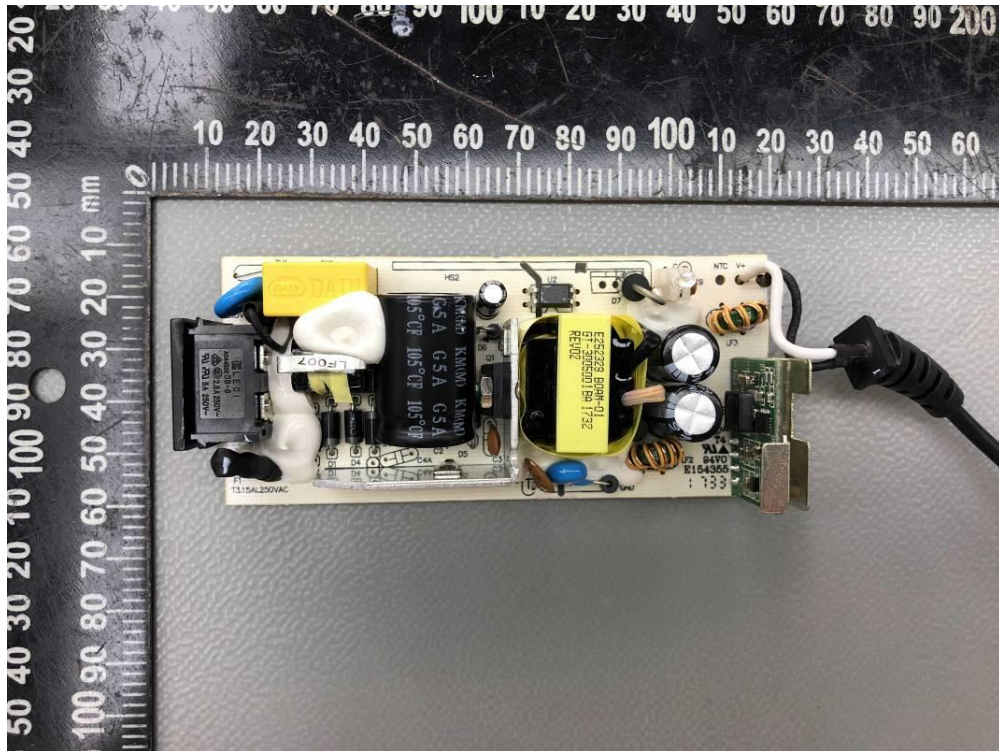

PCB view for GTM91128LI3CEL-****

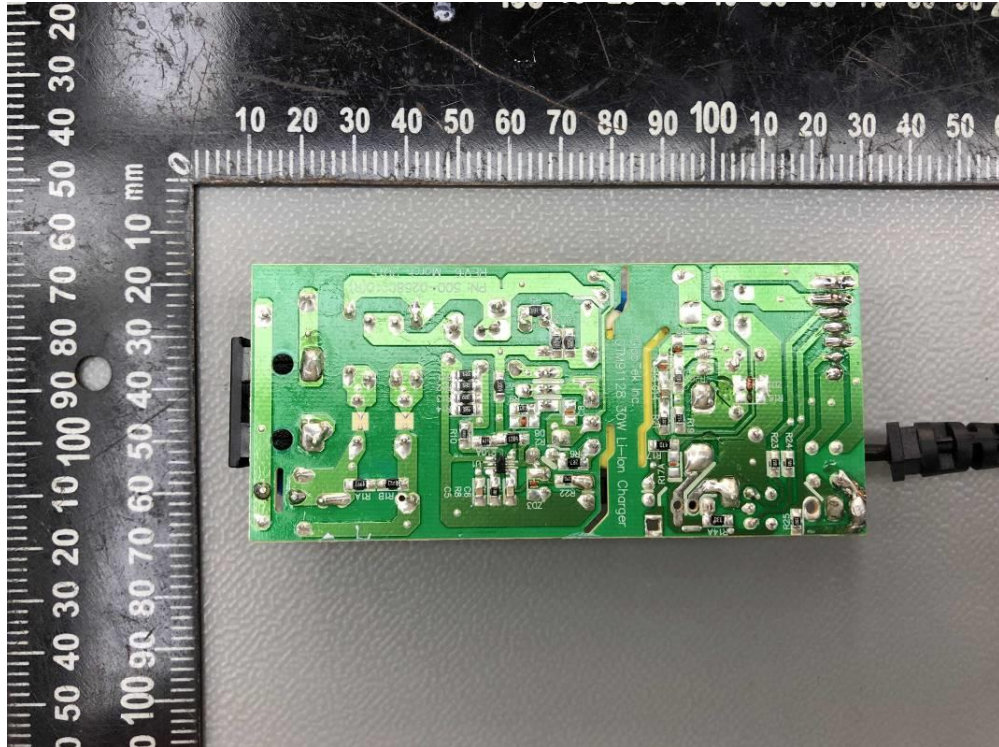

External view for GTM91128LI3CELM-**** or GTM91128*DUALC-****



External view for GTM91128LI3CELM-**** or GTM91128*DUALC-****



Internal view for GTM91128LI3CELM-**** or GTM91128*DUALC-****

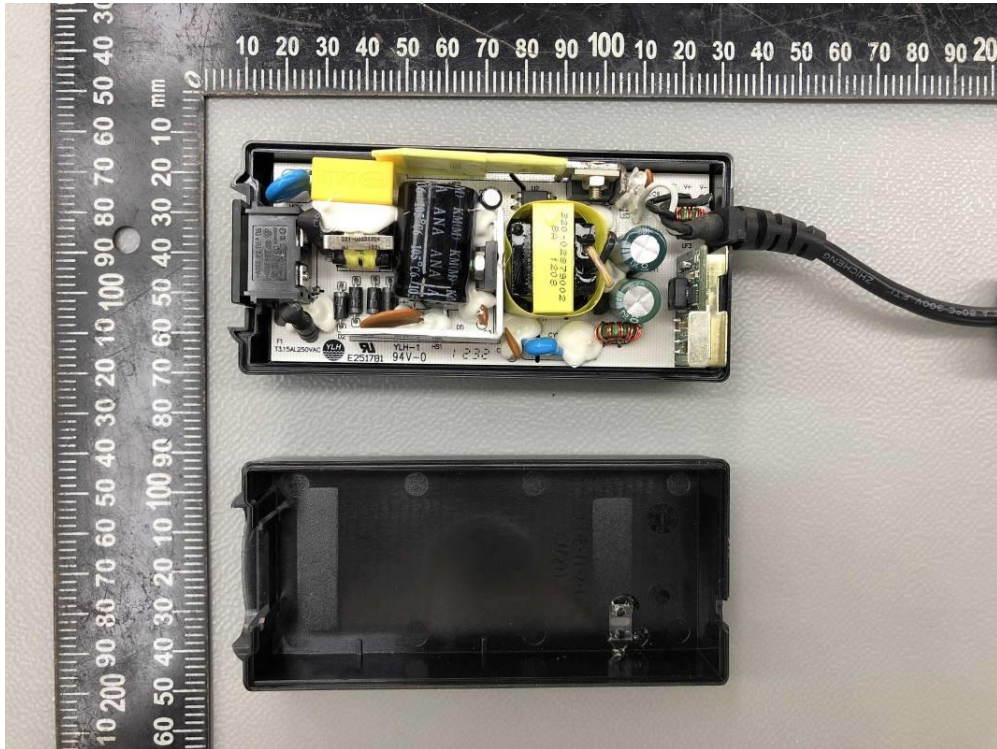

Internal view for GTM91128LI3CELM-**** or GTM91128*DUALC-****

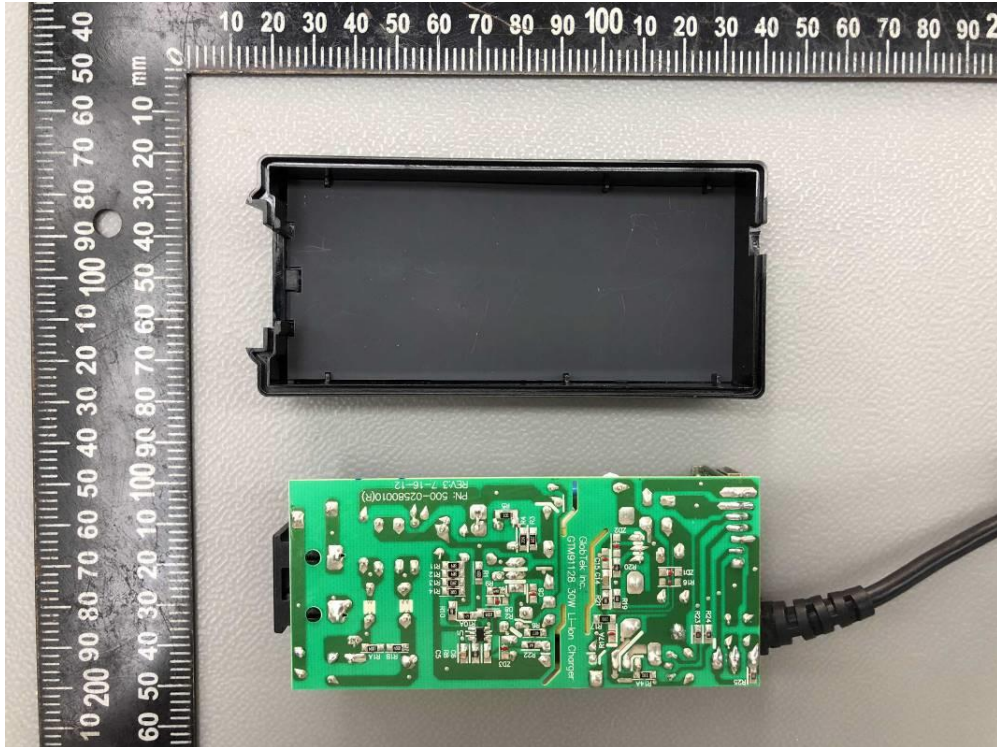

PCB view for GTM91128LI3CELM-**** or GTM91128*DUALC-****

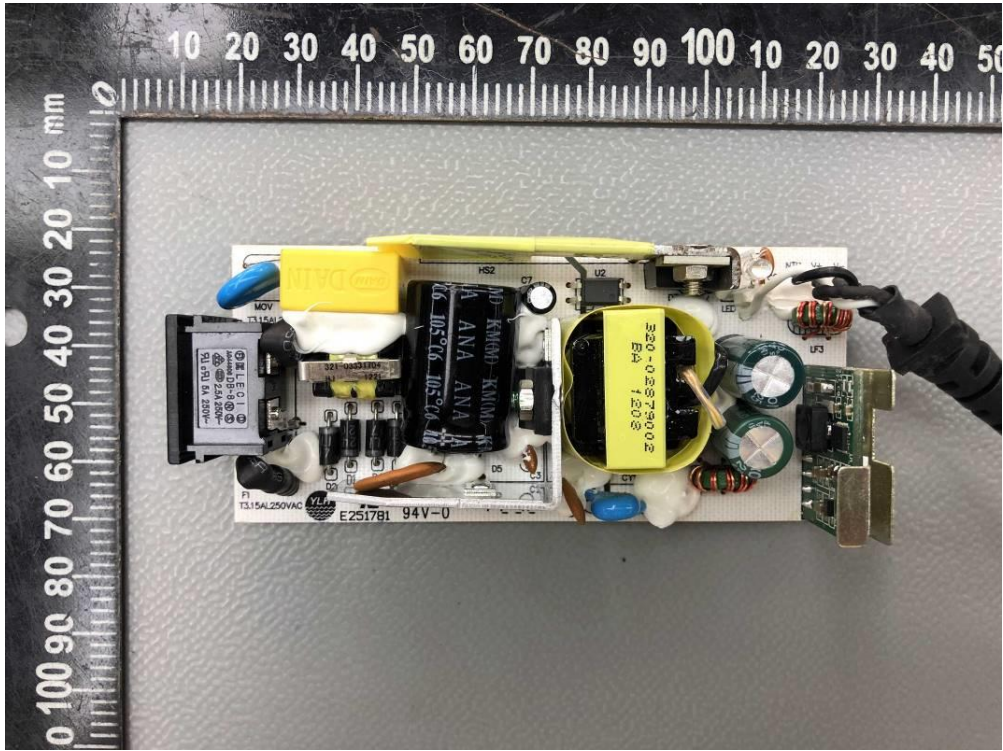

PCB view for GTM91128LI3CELM-**** or GTM91128*DUALC-****

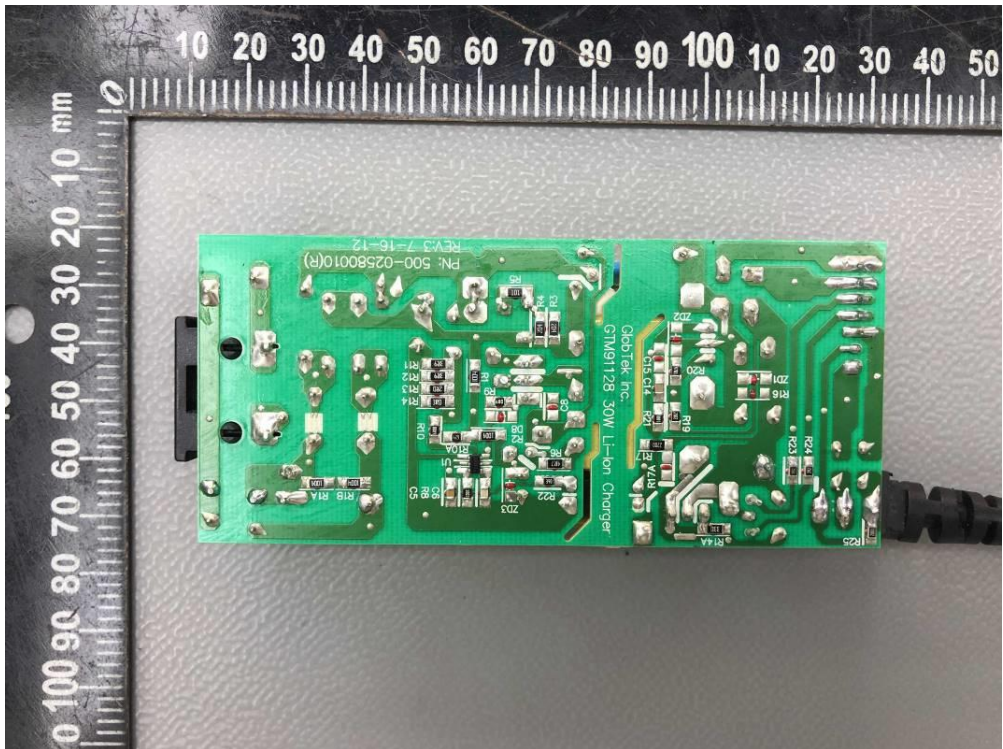

External view for GTM91128LI1CELM-****



External view for GTM91128LI1CELM-****



Internal view for GTM91128LI1CELM-****

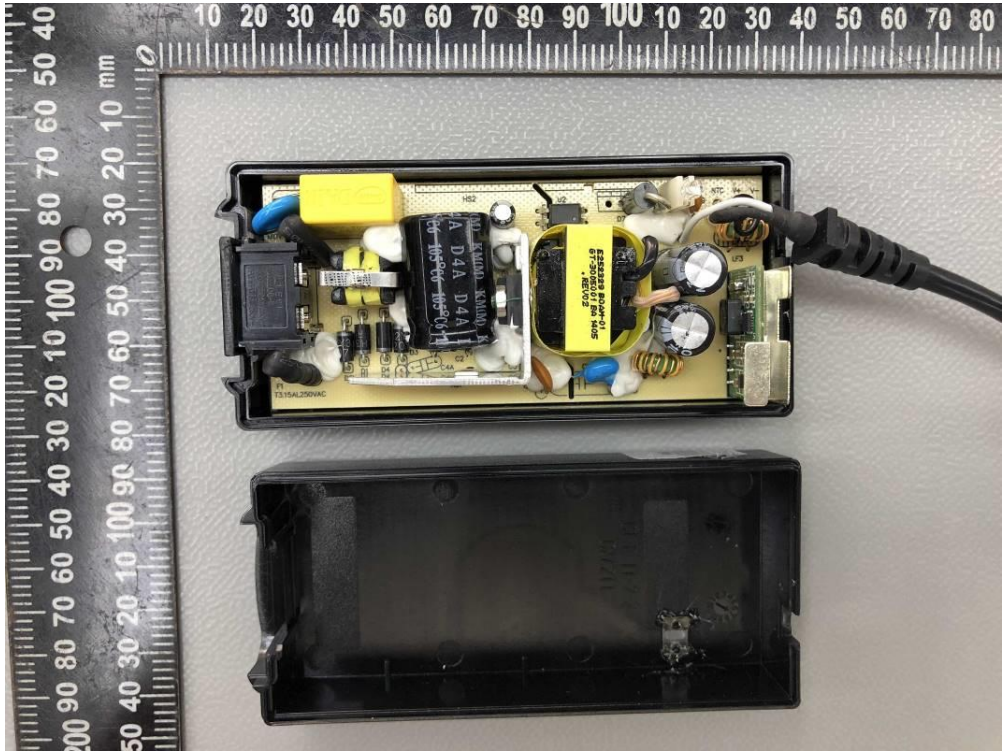

Internal view for GTM91128LI1CELM-****

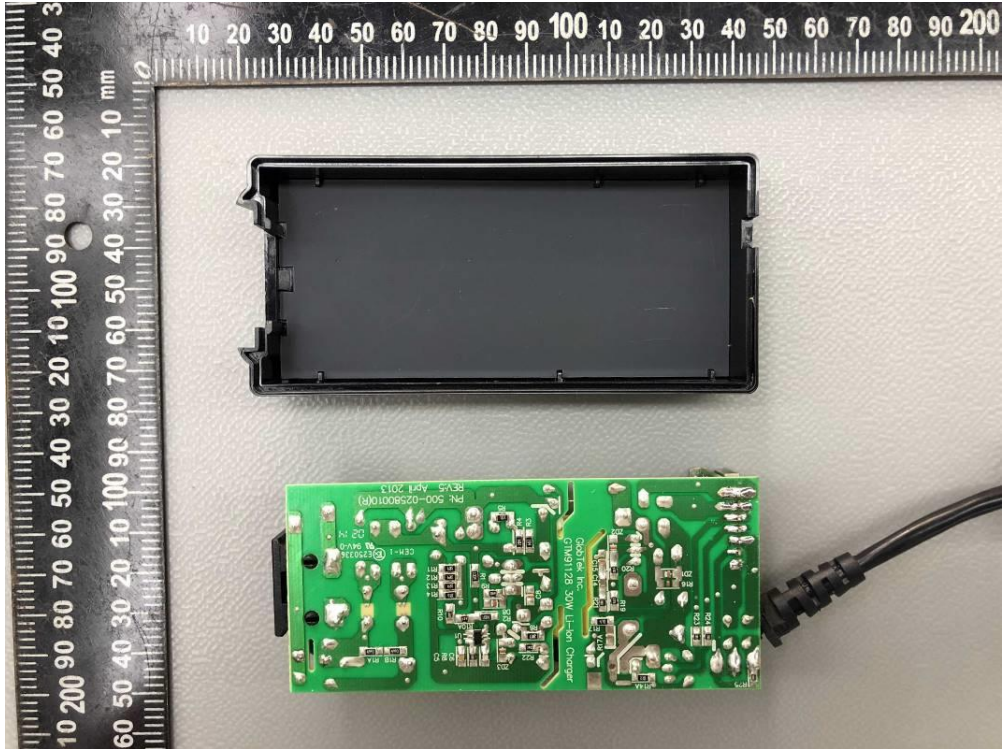

PCB view for GTM91128LI1CELM-****

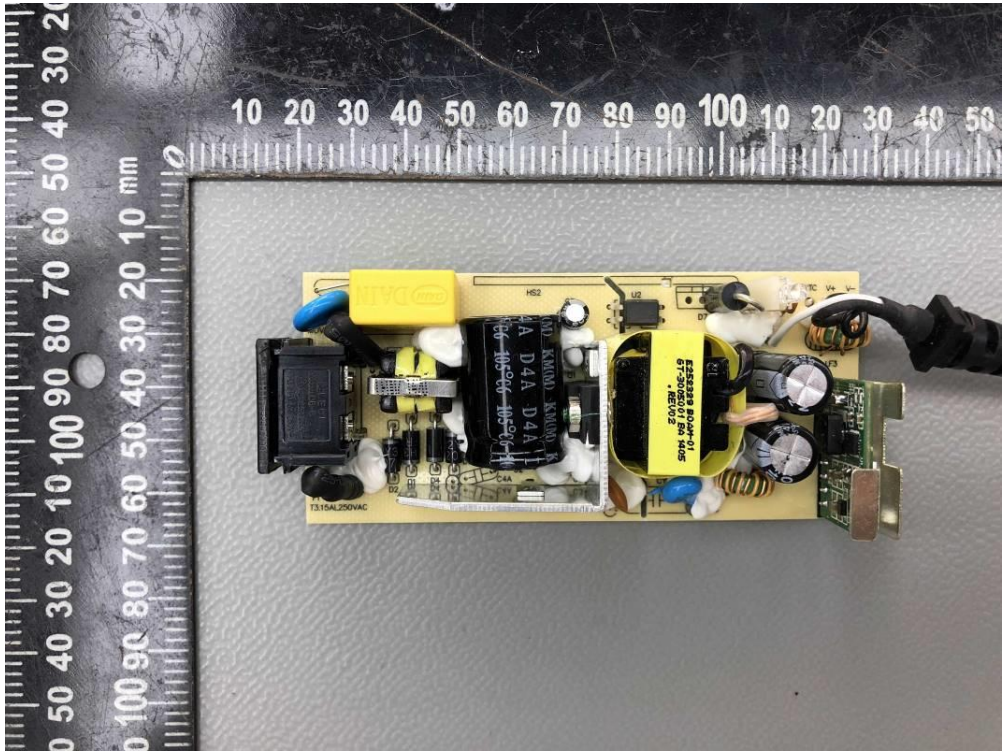

PCB view for GTM91128LI1CELM-****

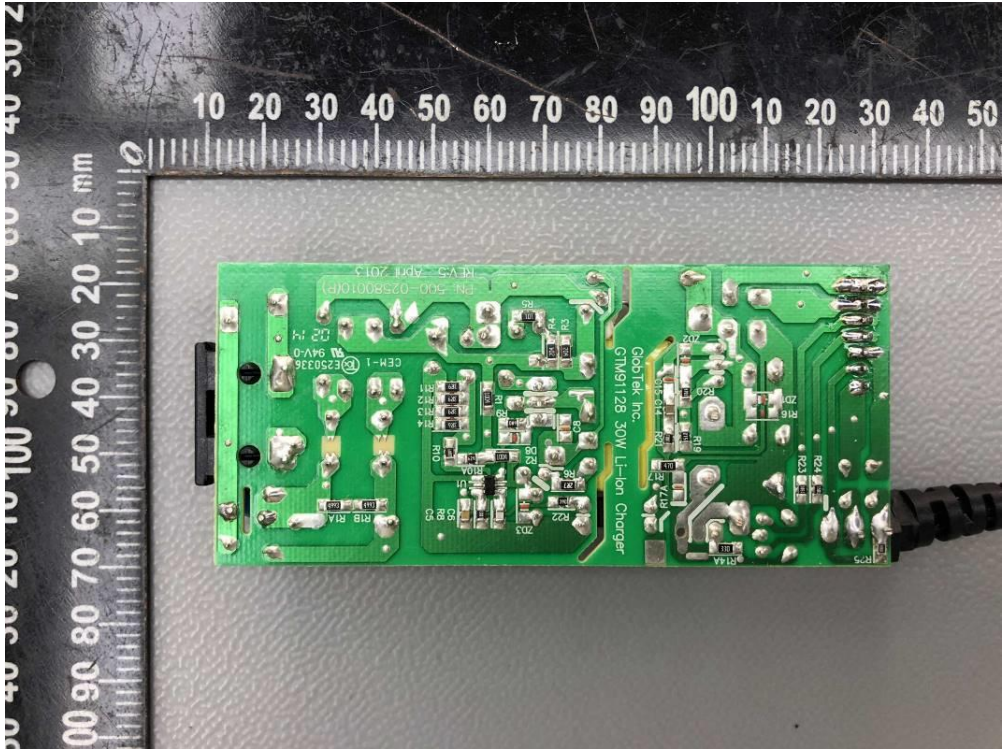

External view for GTM91128LI1CEL-T2-**** and GTM91128LI1CEL-T2A-****



External view for GTM91128LI1CEL-T2-**** and GTM91128LI1CEL-T2A-****



Internal view for GTM91128LI1CEL-T2-**** and GTM91128LI1CEL-T2A-****

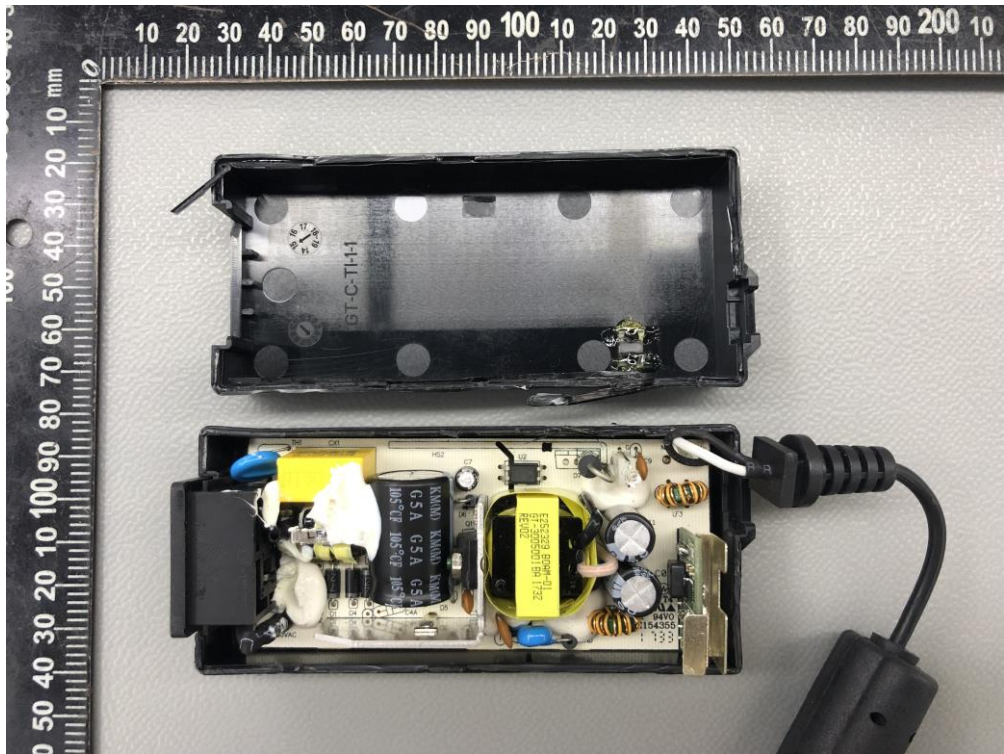

Internal view for GTM91128LI1CEL-T2-**** and GTM91128LI1CEL-T2A-****

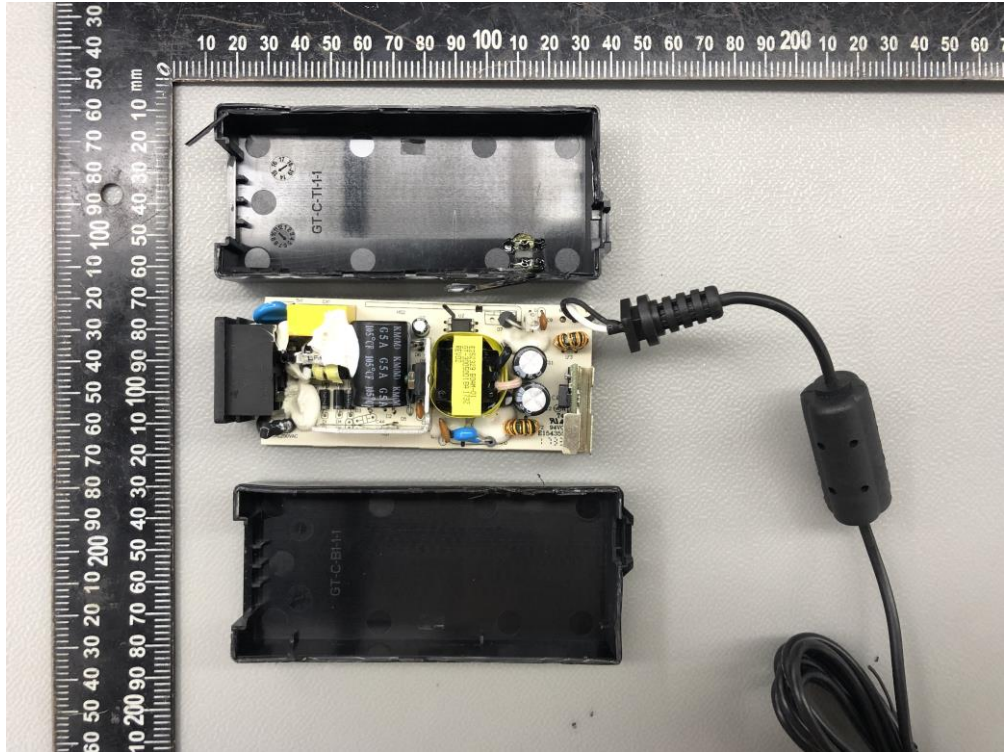

Alternative PCB layout with 2 LEDs

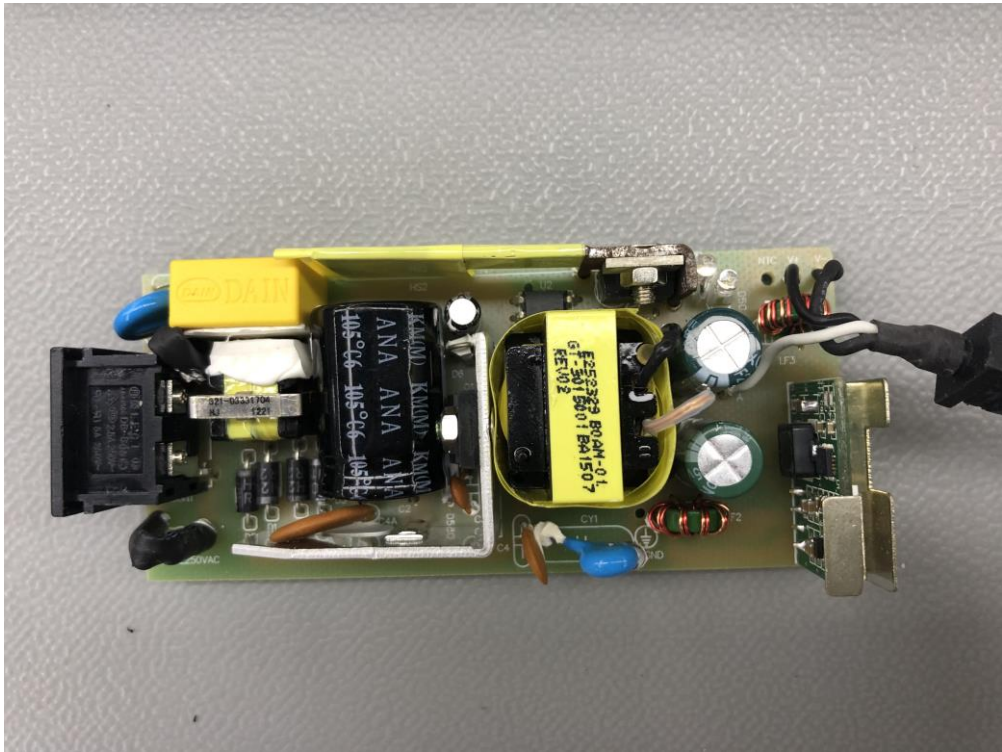

Alternative PCB layout with 2 LEDs

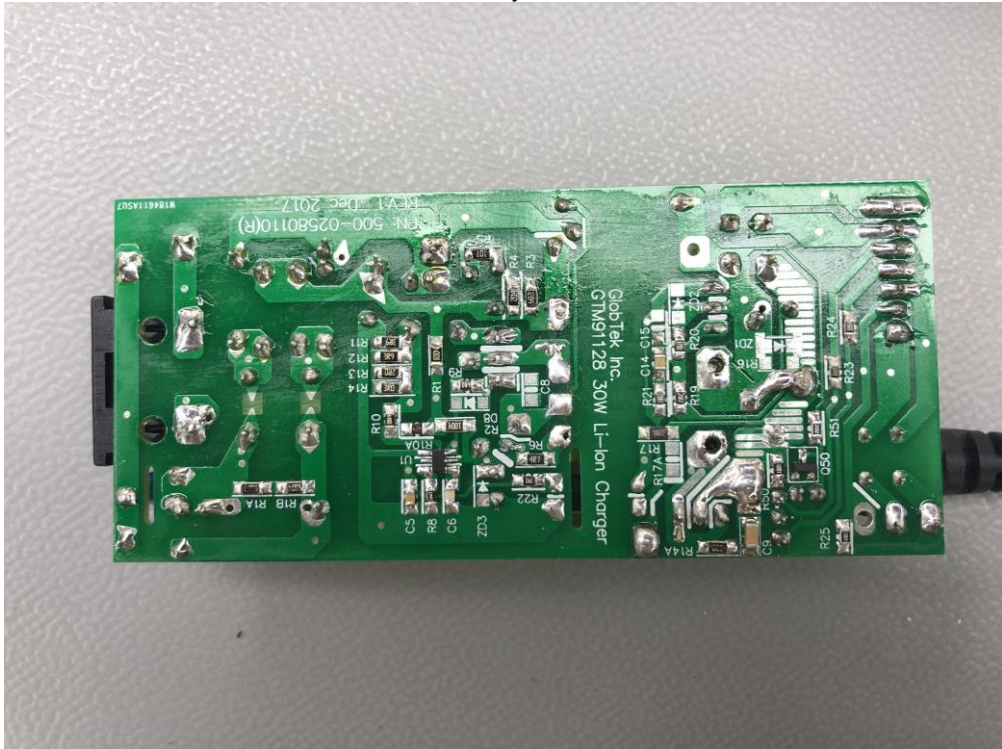

Transformer (EE22)



Transformer (EE22)

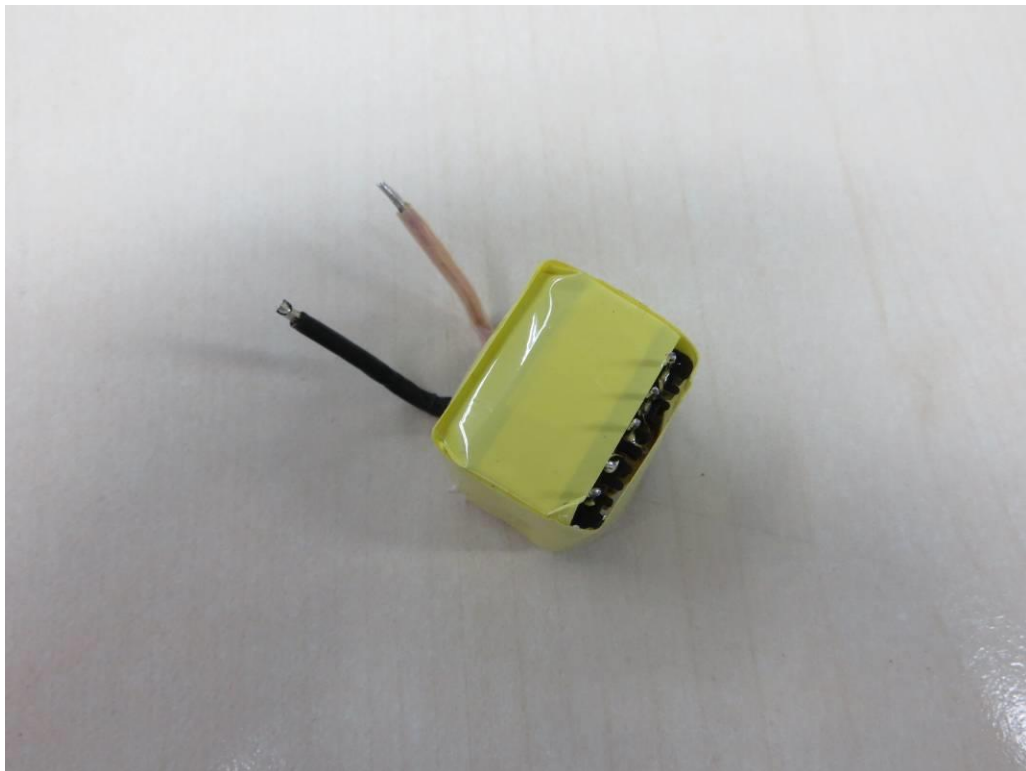

Transformer (EE22)



Transformer (EE22)

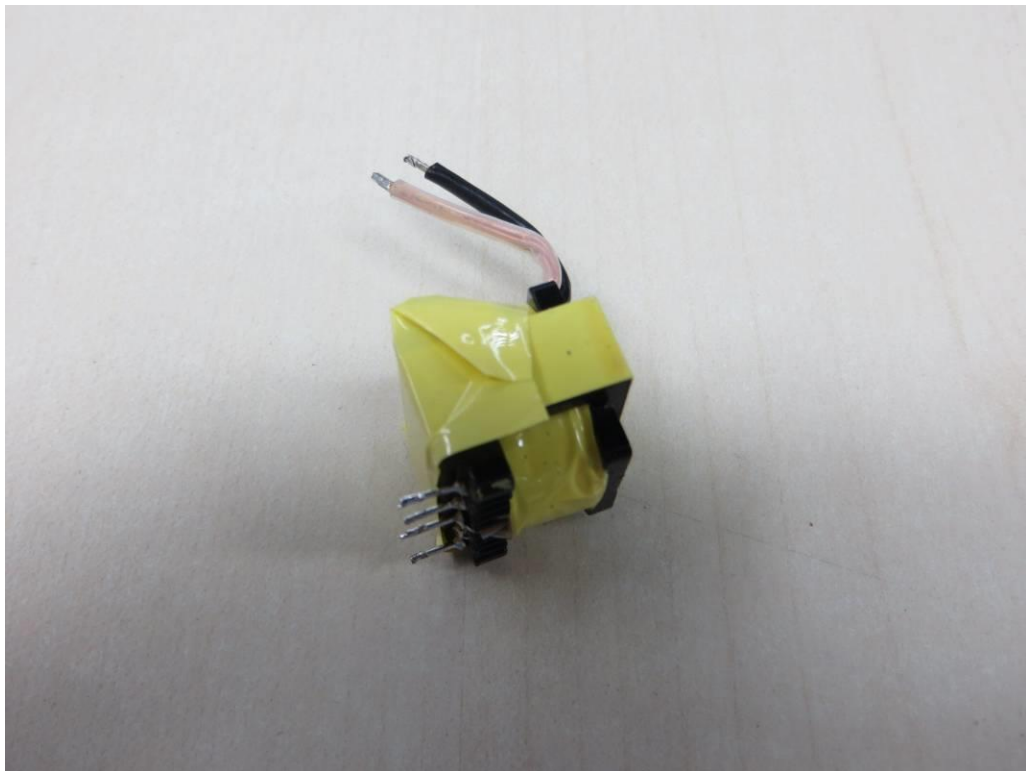

Transformer (EE22)

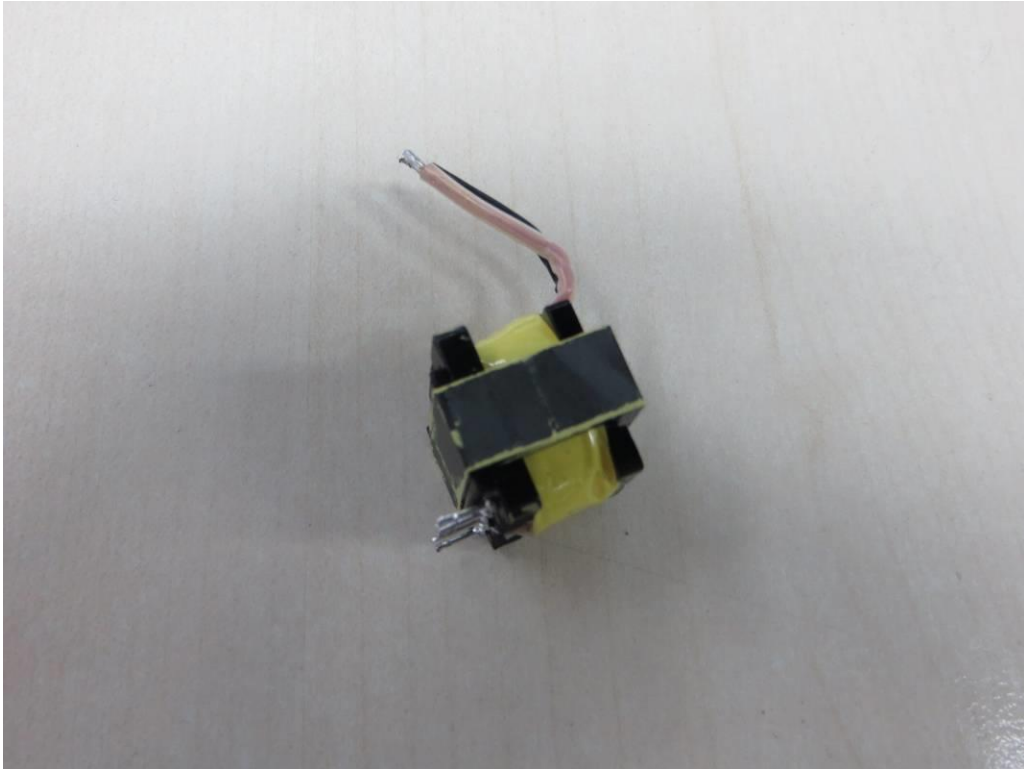

Transformer (EE22)

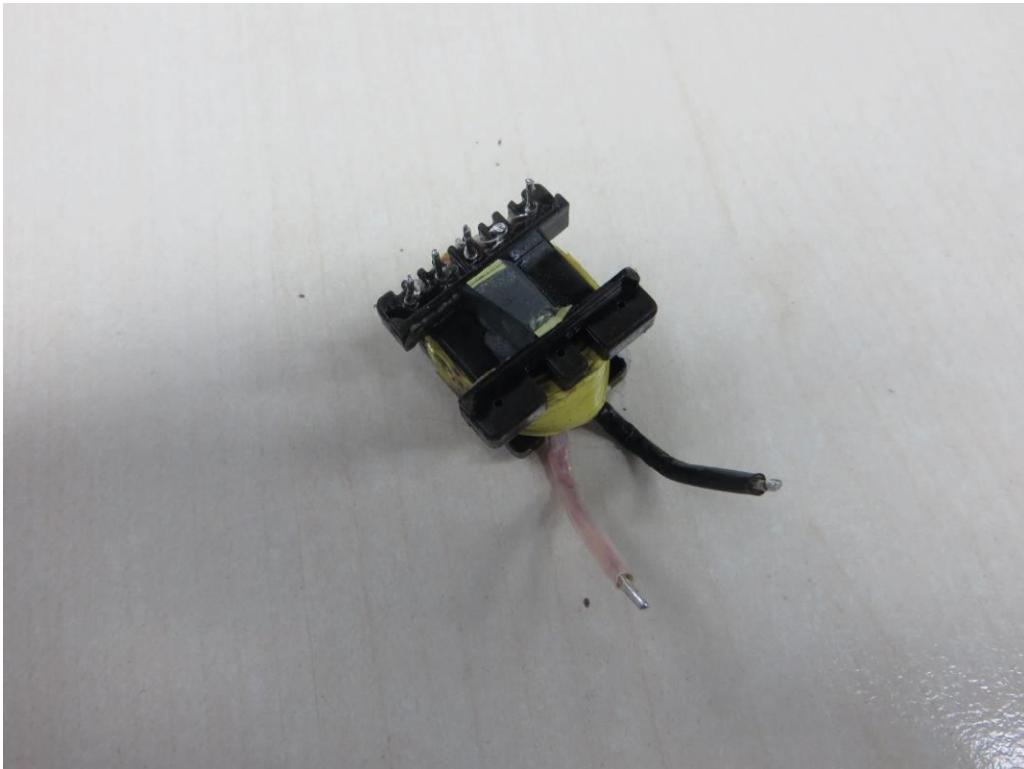

Transformer (EE22)

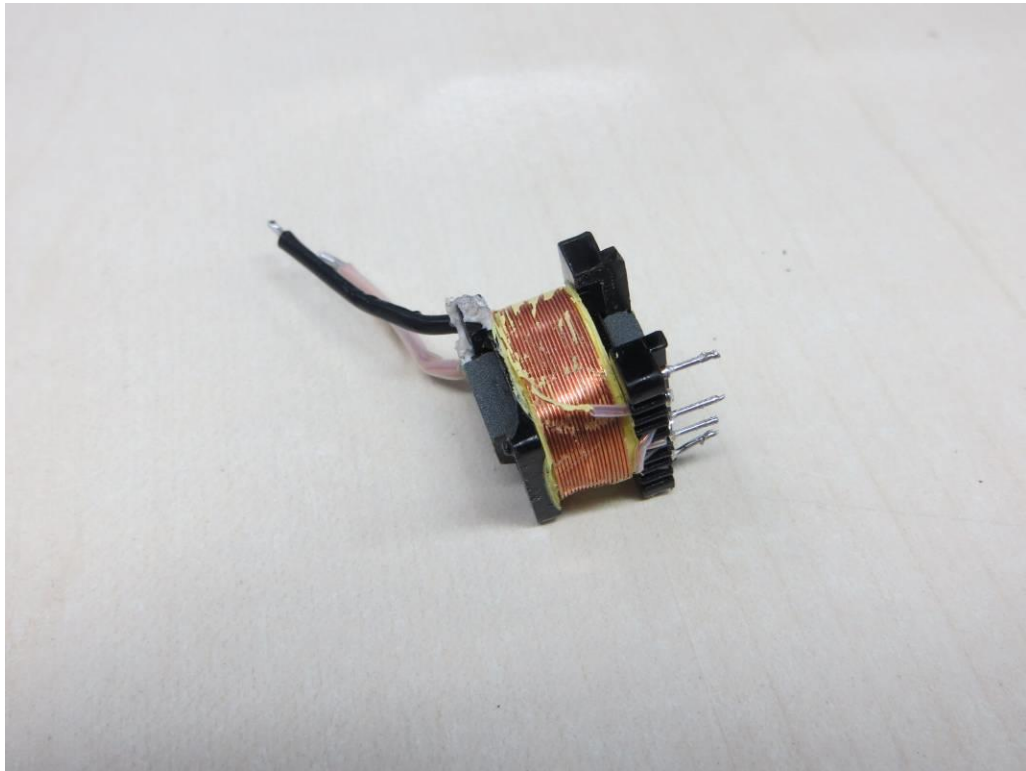

Transformer (EE22)

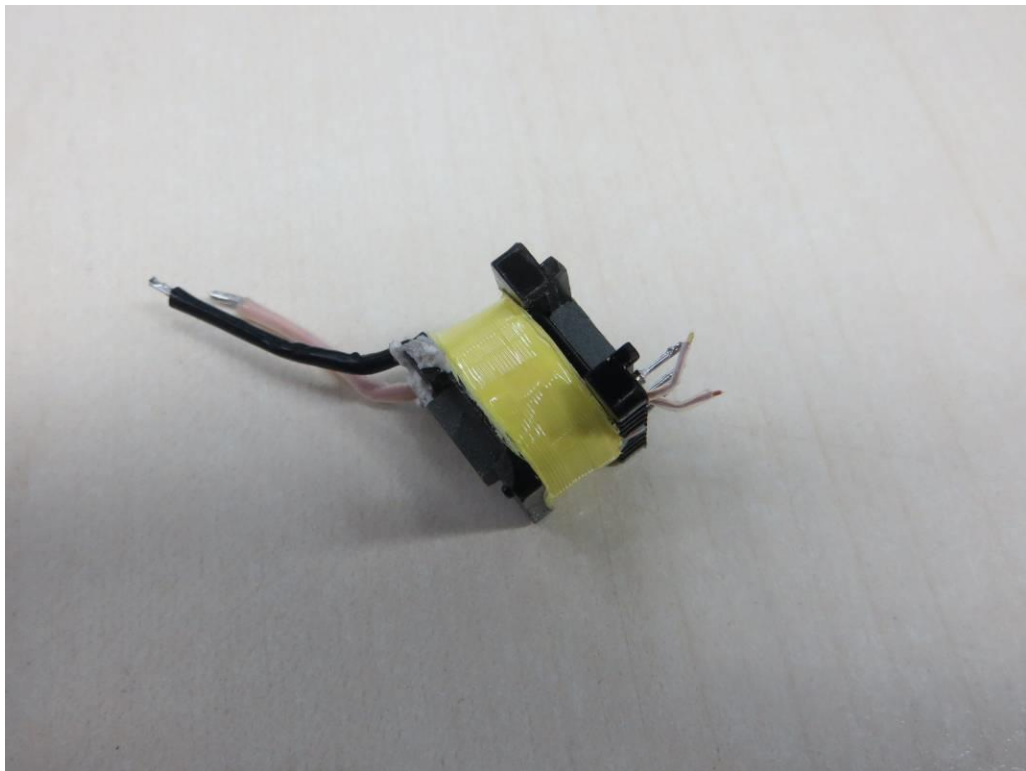

Transformer (EE22)

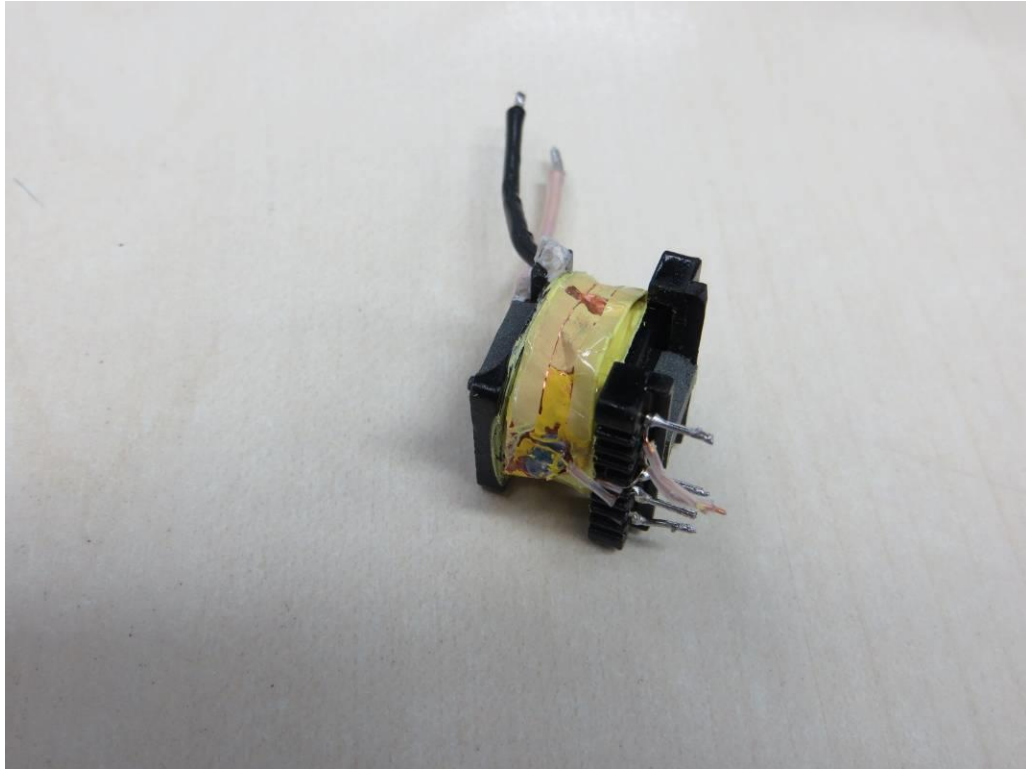

Transformer (EE22)

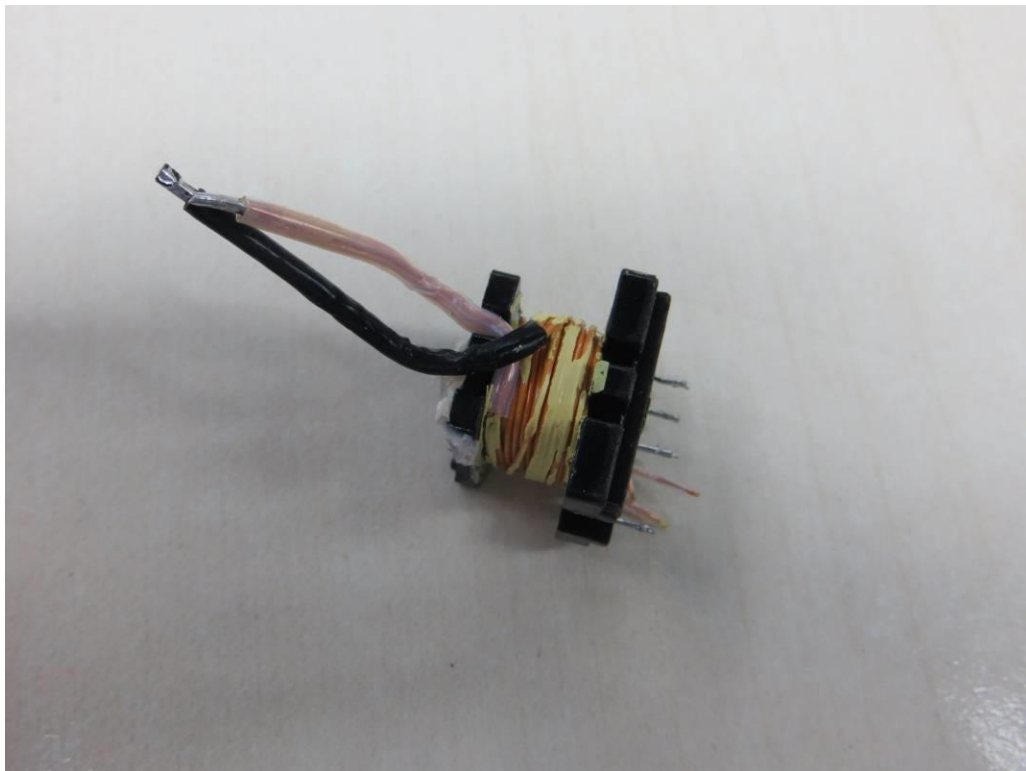

Transformer (EE22)

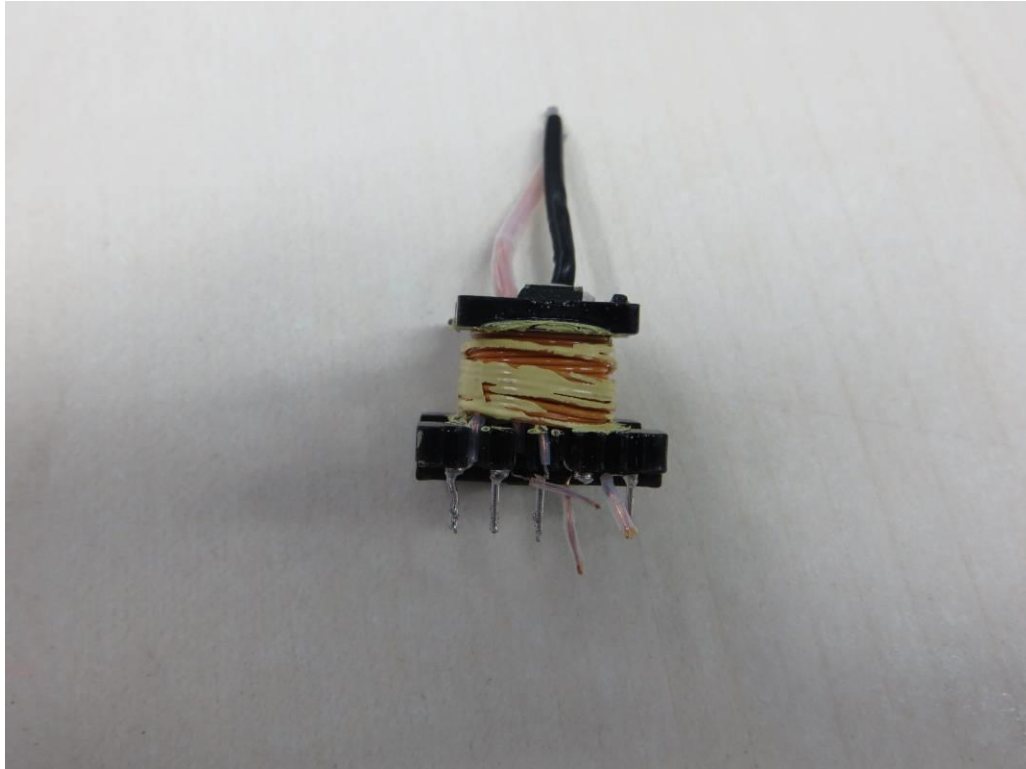

Transformer (EE22)

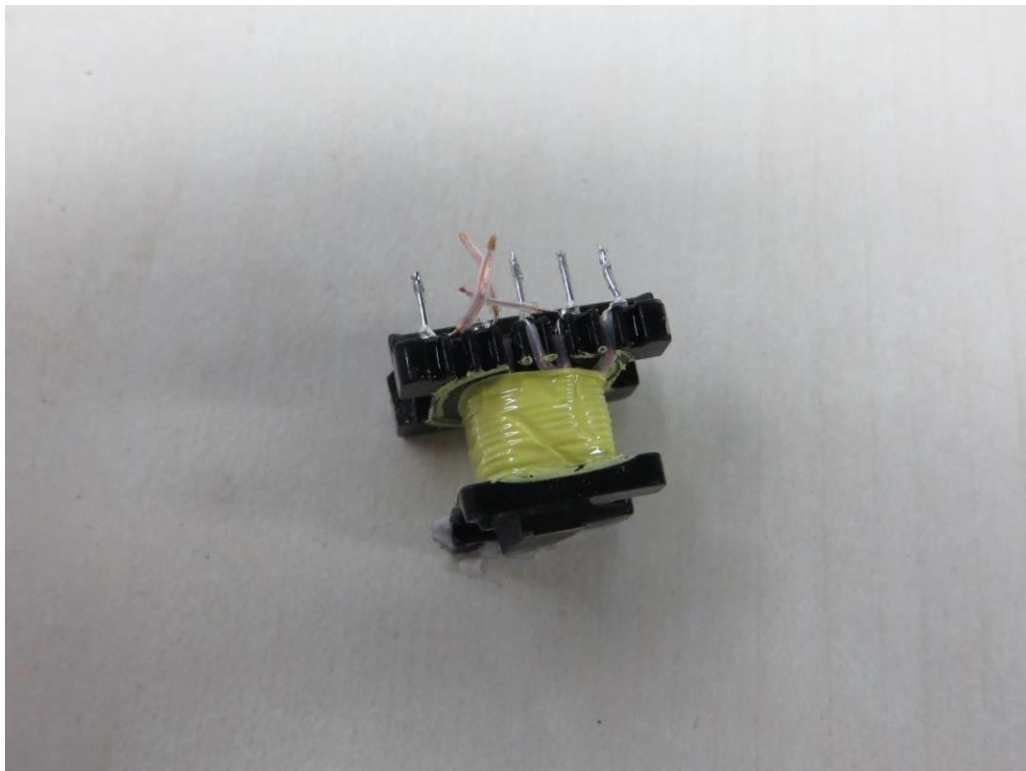

Transformer (EE22)

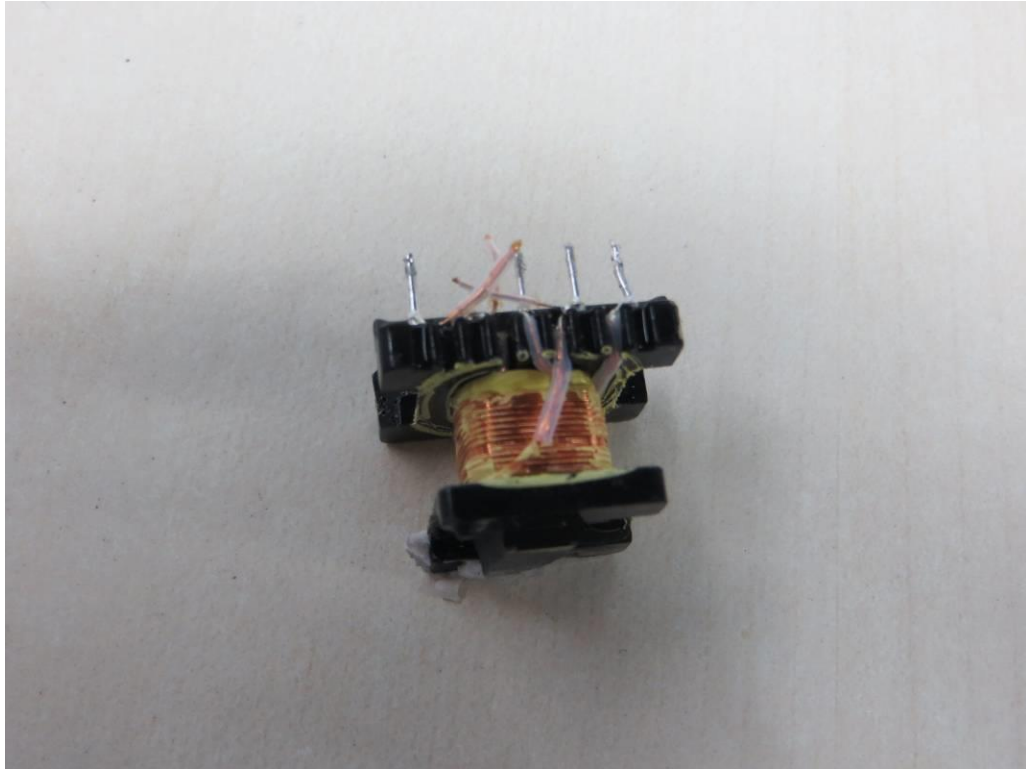

Transformer (EE22)

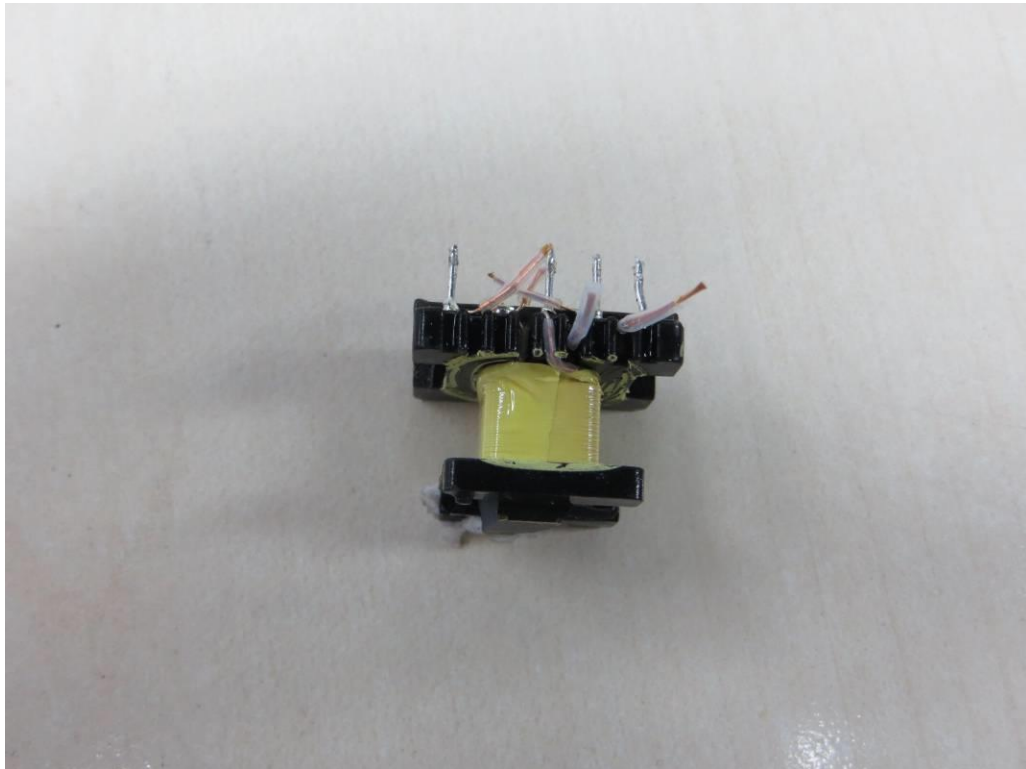

Transformer (EE22)

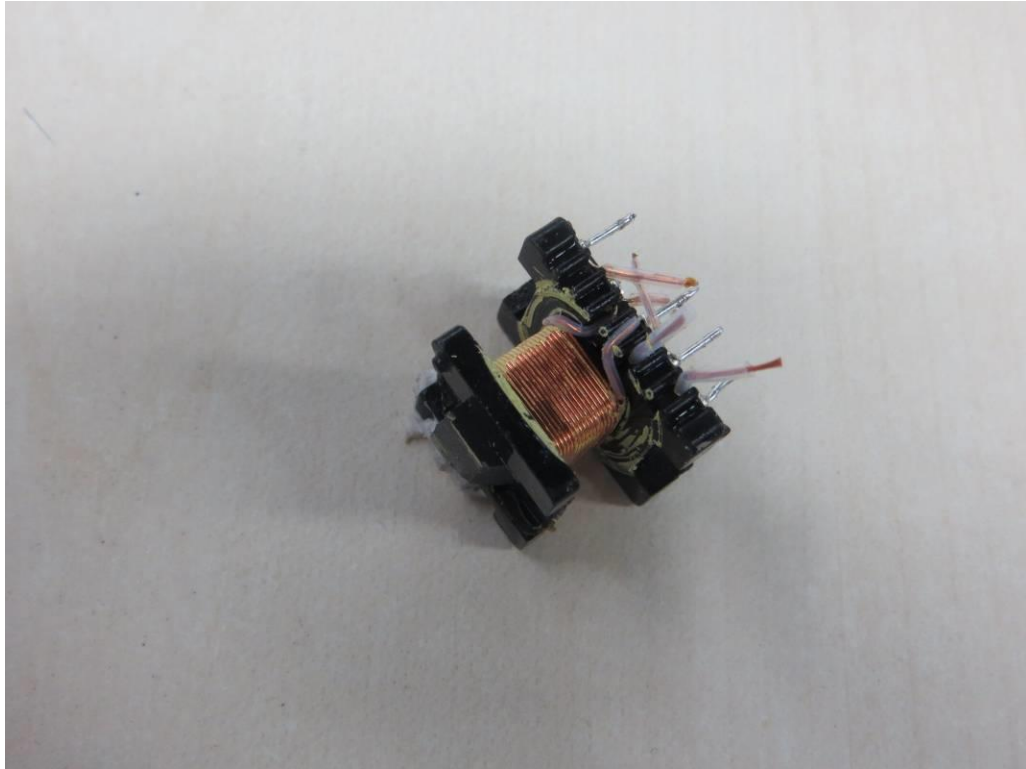

Transformer (EE22)

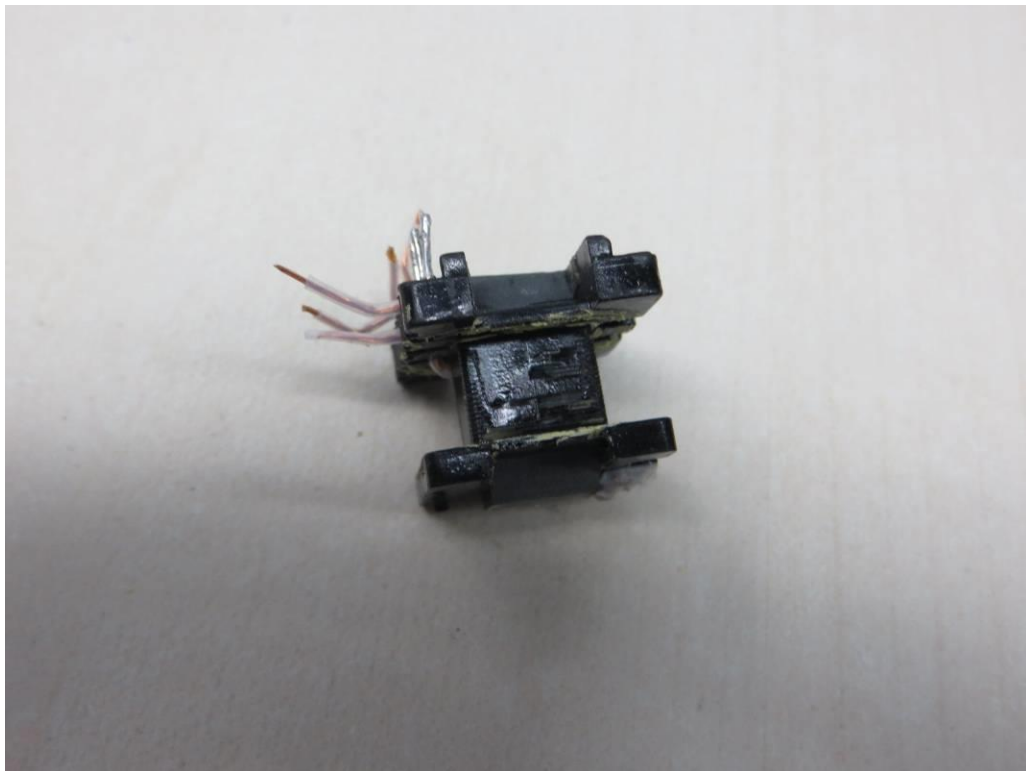

Transformer (EE16)

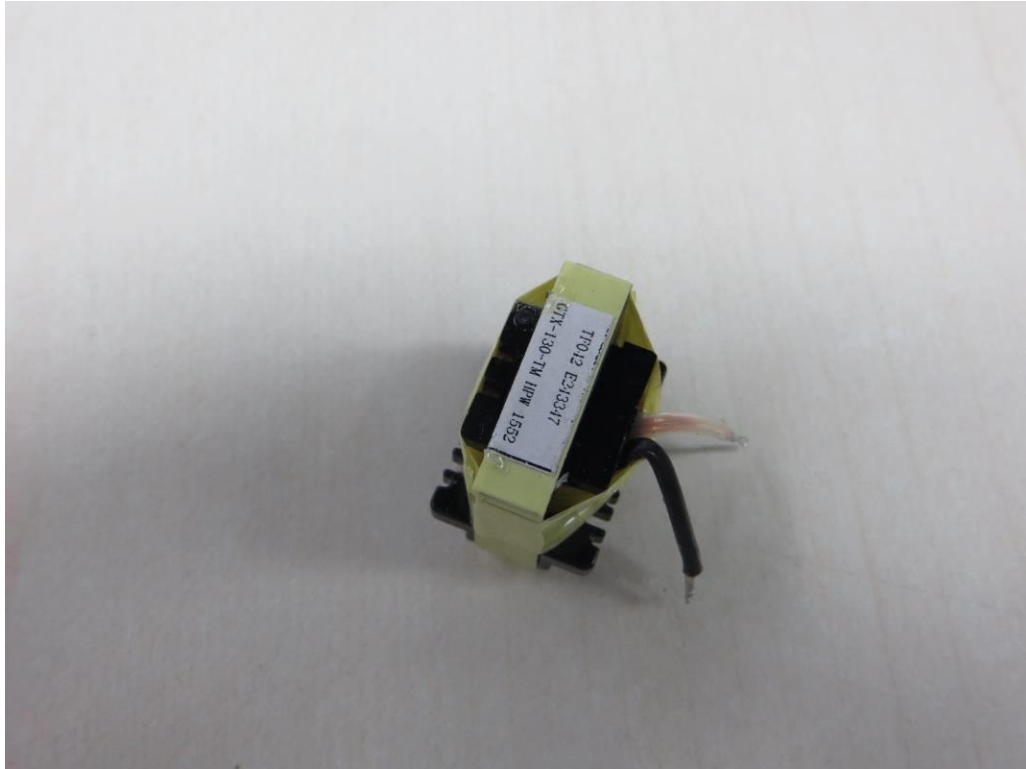

Transformer (EE16)



Transformer (EE16)

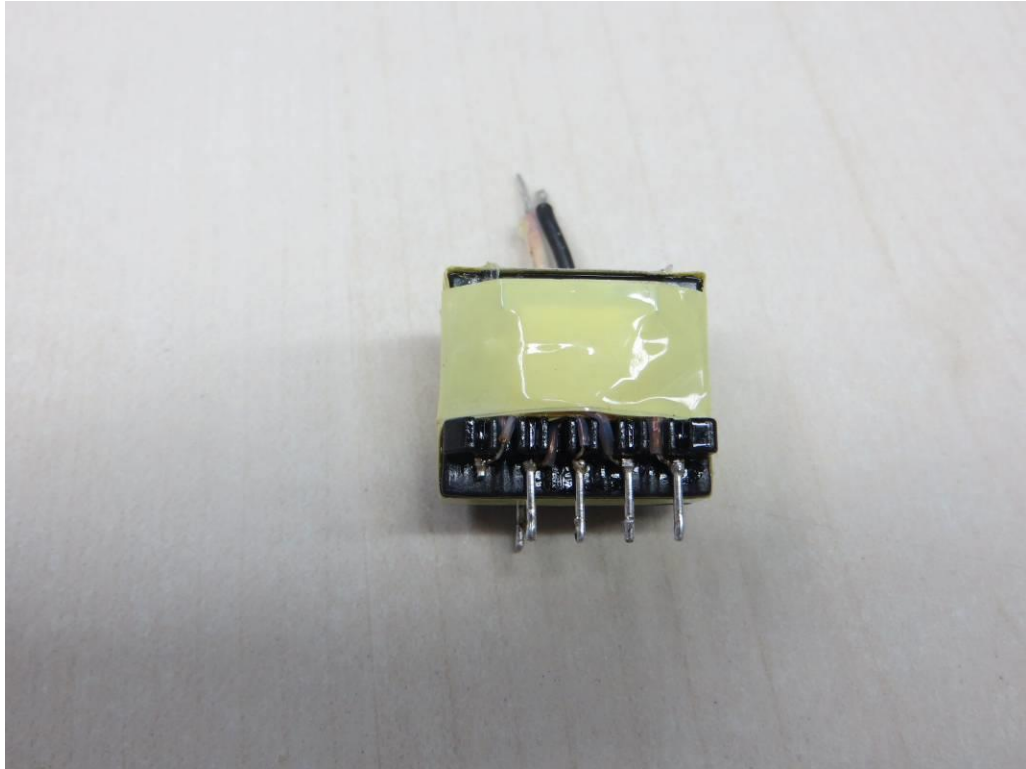

Transformer (EE16)

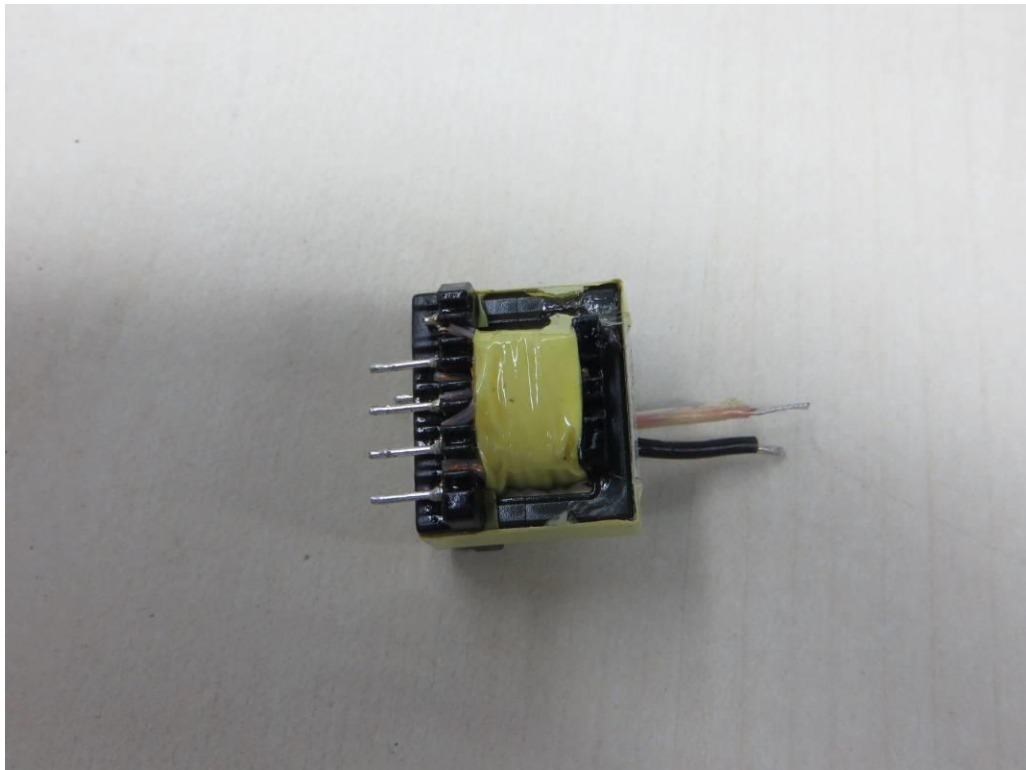

Transformer (EE16)

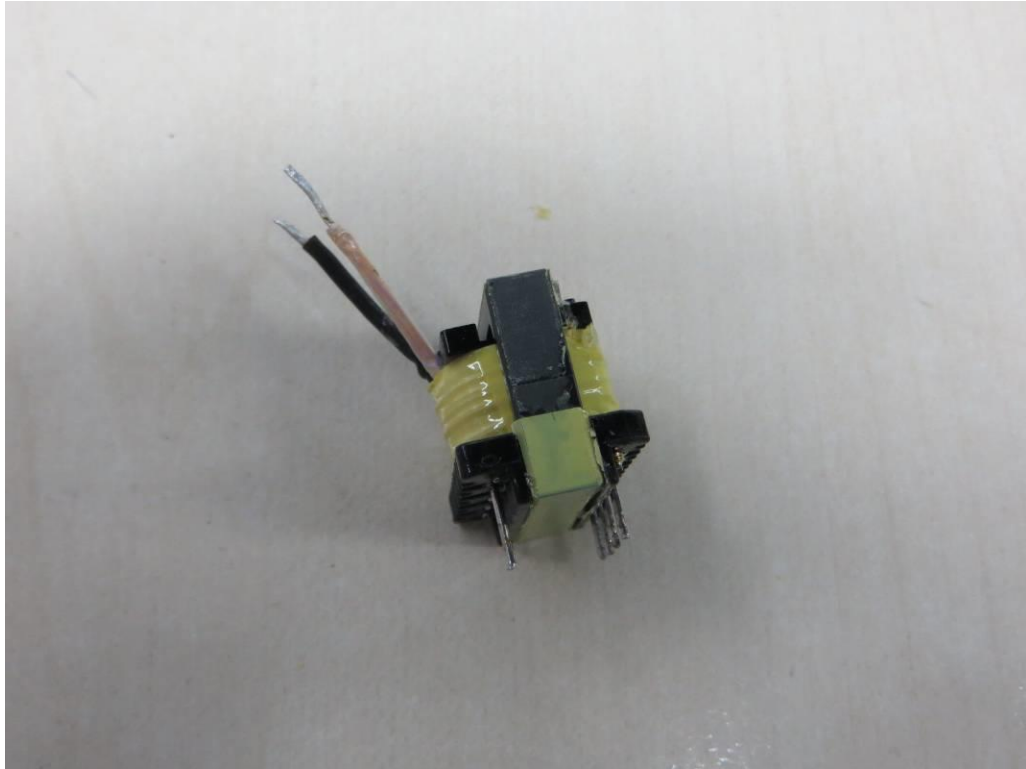

Transformer (EE16)

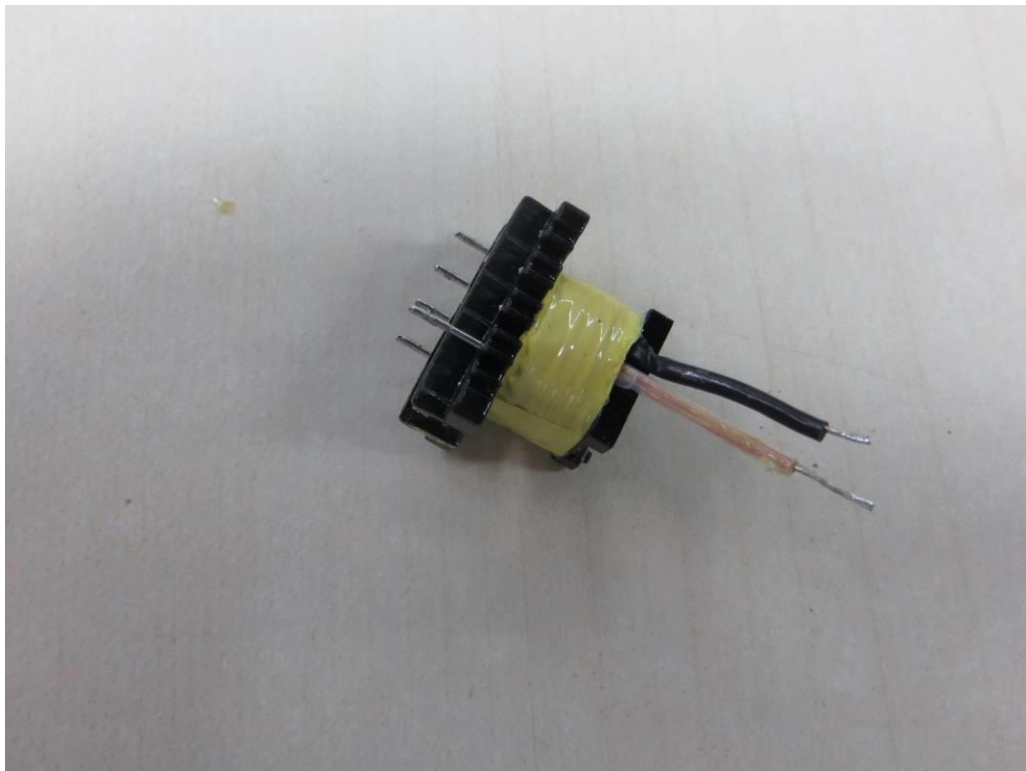

Transformer (EE16)

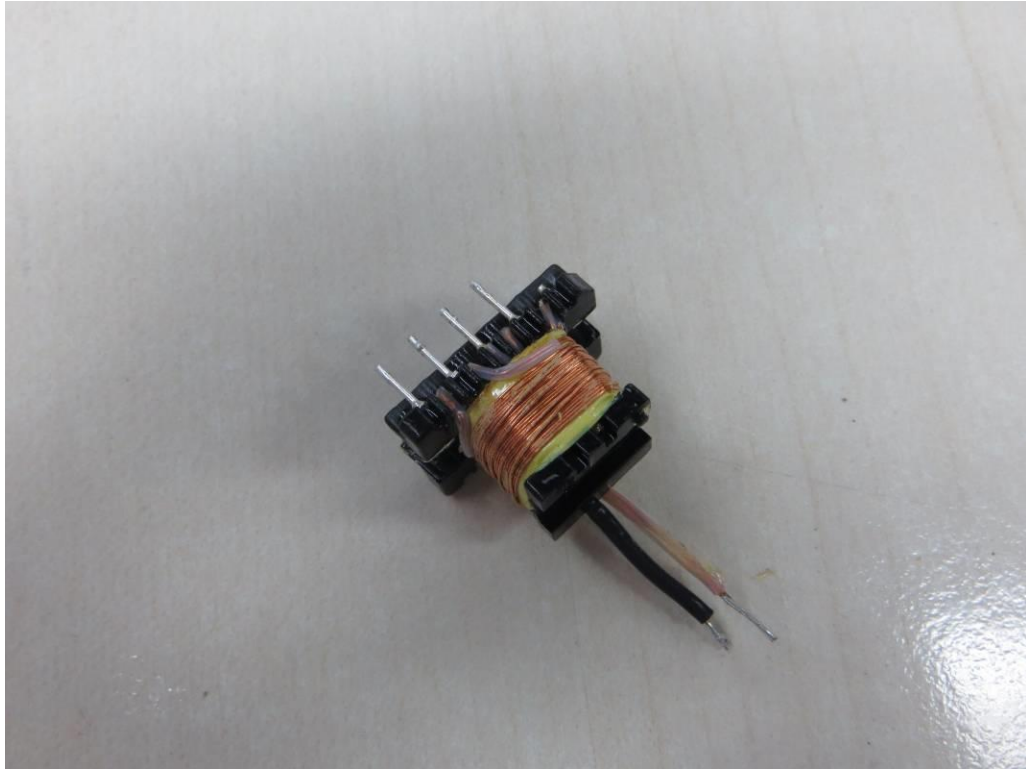

Transformer (EE16)

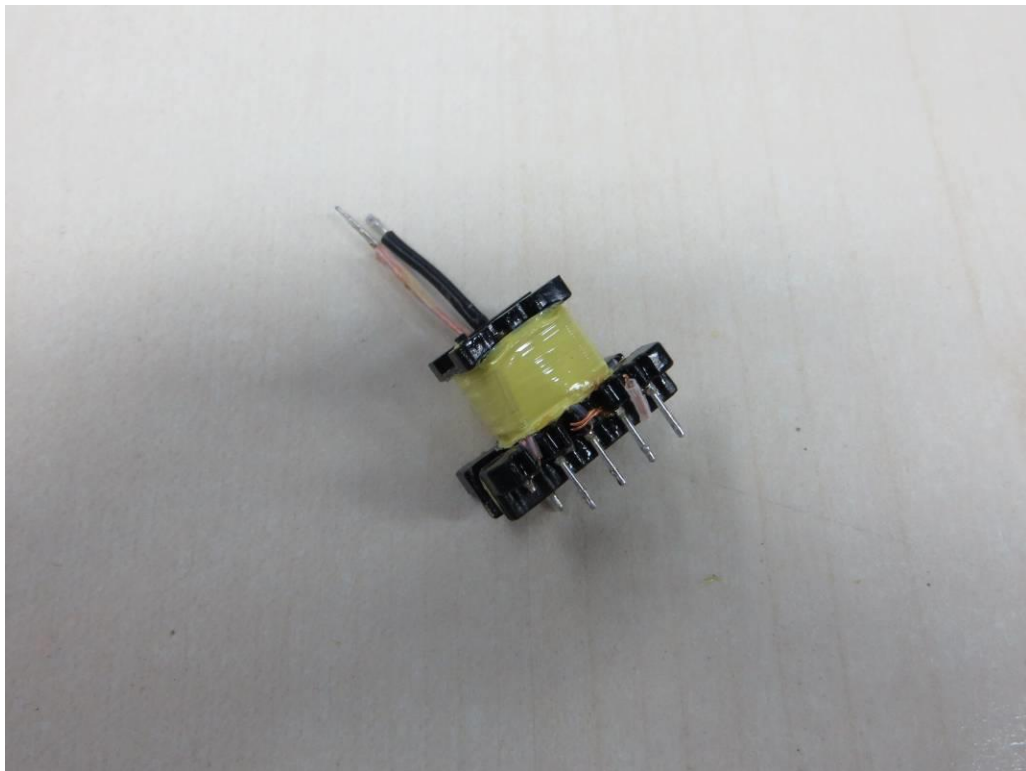

Transformer (EE16)

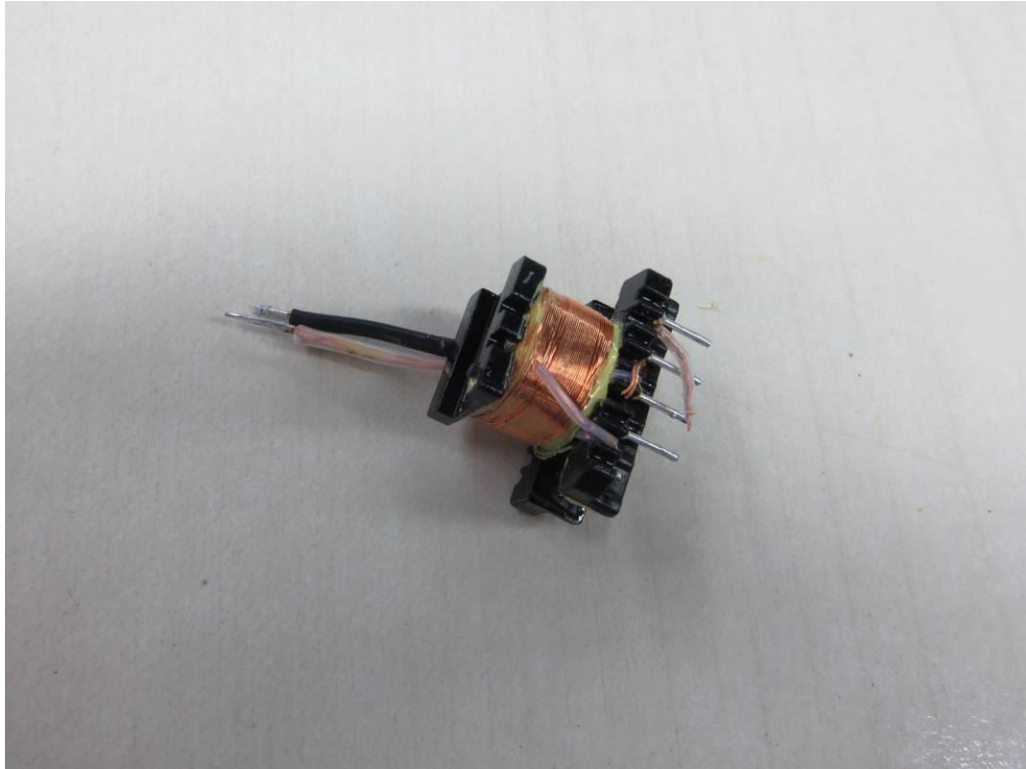

Transformer (EE16)

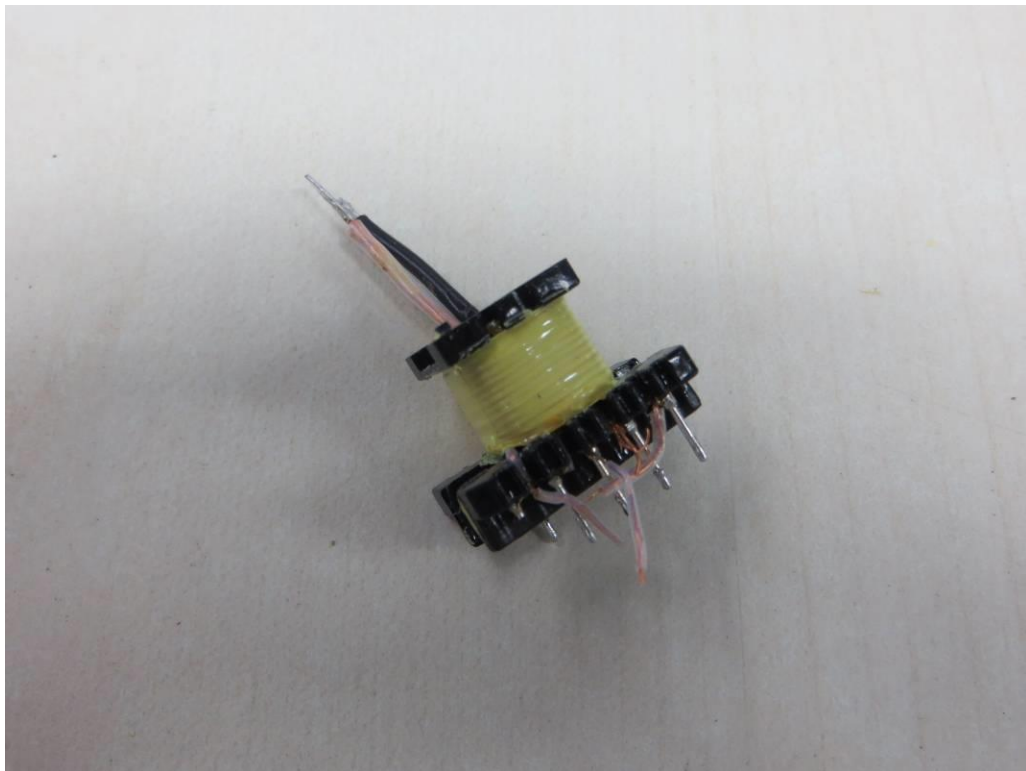

Transformer (EE16)

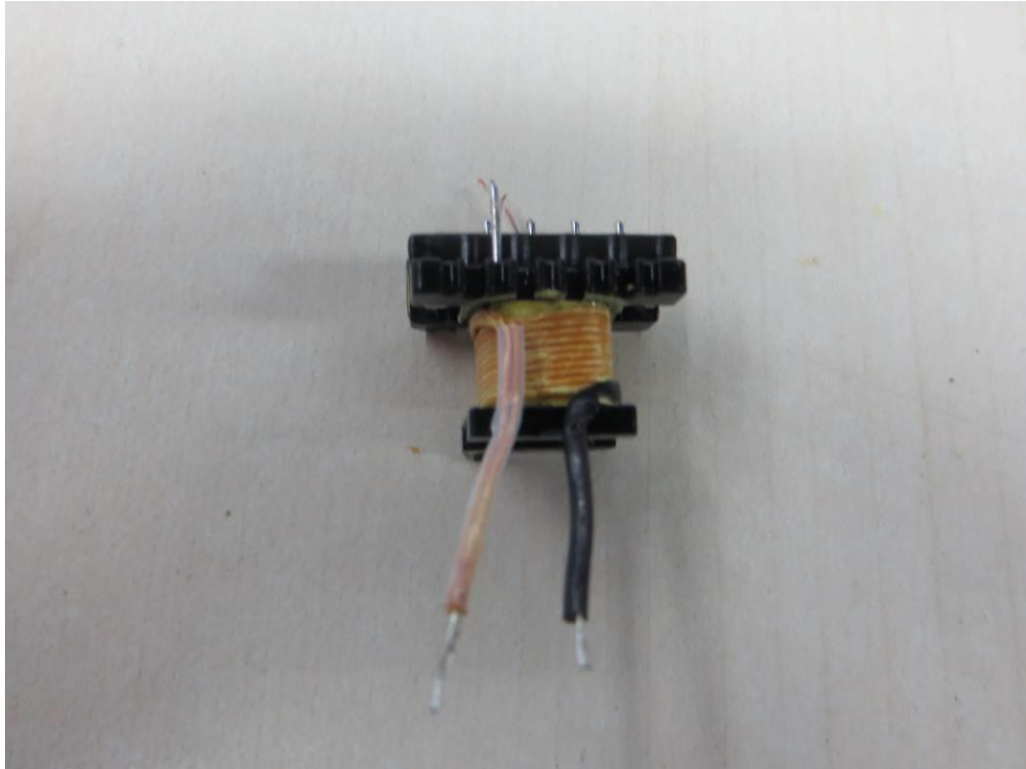

Transformer (EE16)

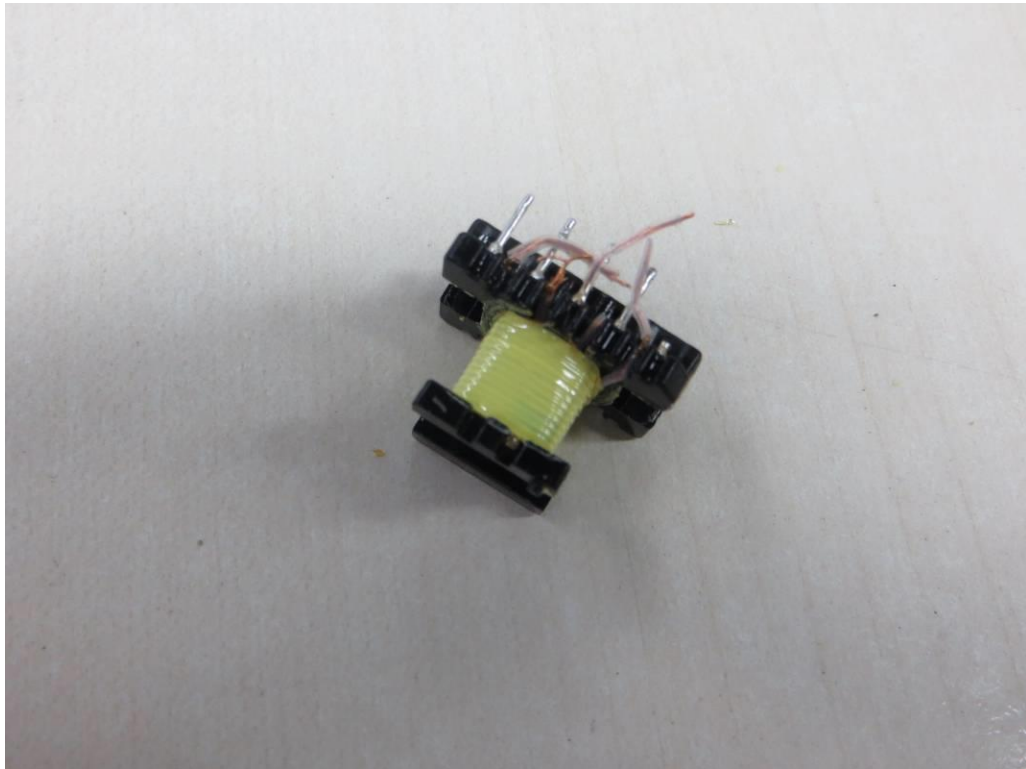

Transformer (EE16)



Transformer (EE16)

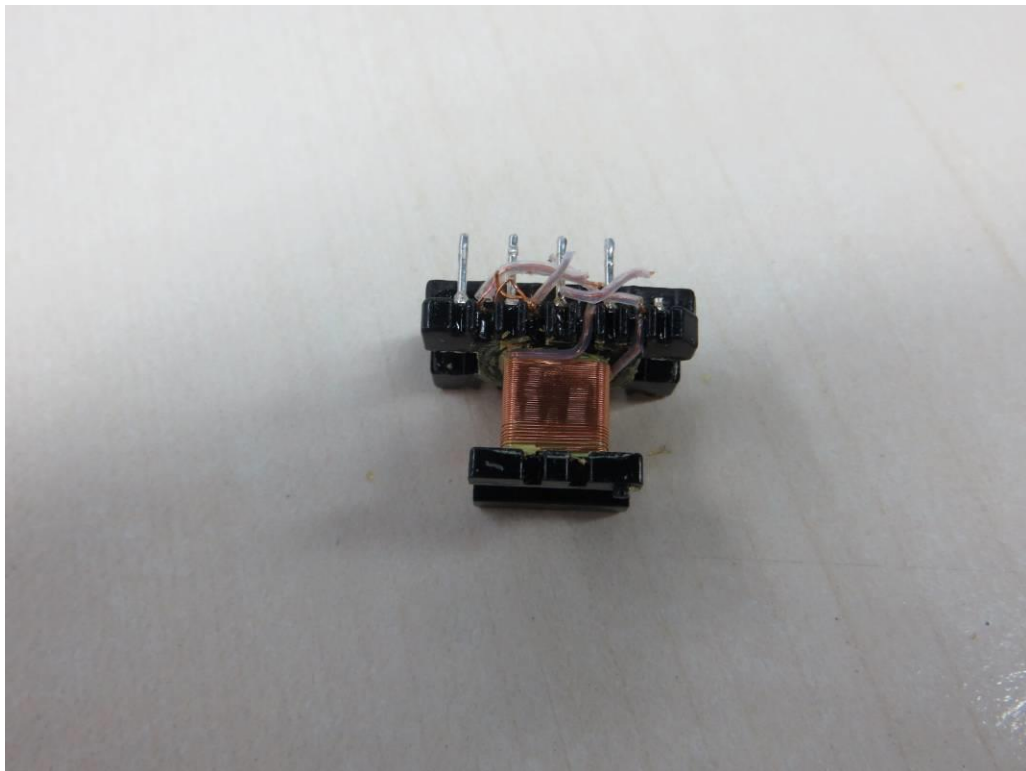

Transformer (EE16)

