



Test Report issued under the responsibility of:



TEST REPORT
IEC 60950-1
Information technology equipment – Safety –
Part 1: General requirements

Report Number..... : SHES150700404301
Date of issue..... : 2016-01-29
Total number of pages : 52 pages

Applicant's name : GlobTek, Inc.
Address..... : 186 Veterans Dr. Northvale, NJ 07647, USA

Test specification:
Standard : IEC 60950-1: 2005 (Second Edition) + Am 1: 2009 + Am 2: 2013
Test procedure : CB Scheme
Non-standard test method : N/A

Test Report Form No. : IEC60950_1F
Test Report Form(s) Originator : SGS Fimko Ltd
Master TRF : Dated 2014-02

Copyright © 2014 IEC System of Conformity Assessment Schemes for Electrotechnical Equipment and Components (IECEE System). All rights reserved.

This publication may be reproduced in whole or in part for non-commercial purposes as long as the IECEE is acknowledged as copyright owner and source of the material. IECEE takes no responsibility for and will not assume liability for damages resulting from the reader's interpretation of the reproduced material due to its placement and context.

If this Test Report Form is used by non-IECEE members, the IECEE/IEC logo and the reference to the CB Scheme procedure shall be removed.

This report is not valid as a CB Test Report unless signed by an approved CB Testing Laboratory and appended to a CB Test Certificate issued by an NCB in accordance with IECEE 02.

General disclaimer:
The test results presented in this report relate only to the object tested.
This report shall not be reproduced, except in full, without the written approval of the Issuing CB Testing Laboratory. The authenticity of this Test Report and its contents can be verified by contacting the NCB, responsible for this Test Report.

Test item description :	I.T.E. Power Supply (Switch Mode)
Trade Mark :	 GlobTek® ,Inc.
Manufacturer :	Same as applicant
Model/Type reference :	GT-46050-WW05-W2Z***** (Each * = 0-9 or A-Z or ()) or blank for marketing purposes)
Ratings :	Input: 100 - 240 V; 50 - 60 Hz; 0,3 A DC-Output: See page 6 – 7 for details Class II

Testing procedure and testing location:	
<input checked="" type="checkbox"/> SGS-CSTC Standards Technical Services (Shanghai) Co., Ltd.	SGS-CSTC Standards Technical Services (Shanghai) Co., Ltd.
Testing location/ address.....:	588 West Jindu Road, Xinqiao Town, Songjiang, 201612 Shanghai, China
<input type="checkbox"/> Associated CB Testing Laboratory:	
Testing location/ address.....:	
Tested by (name + signature)	Will Zhou <i>Will Zhou</i>
Approved by (name + signature)	Cherry Sun <i>Cherry Sun</i>
<input type="checkbox"/> Testing procedure: TMP/CTF Stage 1:	
Testing location/ address.....:	
Tested by (name + signature)	
Approved by (name + signature)	
<input type="checkbox"/> Testing procedure: WMT/CTF Stage 2:	
Testing location/ address.....:	
Tested by (name + signature)	
Witnessed by (name + signature).....:	
Approved by (name + signature)	
<input type="checkbox"/> Testing procedure: SMT/CTF Stage 3 or 4:	
Testing location/ address.....:	
Tested by (name + signature)	
Witnessed by (name + signature).....:	
Approved by (name + signature)	
Supervised by (name + signature)	

<p>List of Attachments (including a total number of pages in each attachment):</p> <p>Attachment 1 – 3 pages of Photos documents; Attachment 2 – 2 pages of Circuit diagram and PCB layout; Attachment 3– 1 page of User manual; Attachment 4 – 19 pages of European group differences and national differences; Attachment 5– 7 pages deviations of Australia and/or New Zealand; Attachment 6 – 1 page deviation of Korea; Attachment 7– 12 pages deviation of JAPAN; Attachment 8 – 4 pages of REGULATORY REQUIREMENTS FOR SINGAPORE; Attachment 9 – 6 pages of deviation of China.</p>	
<p>Summary of testing:</p> <p>The sample(s) tested complies with the requirements of IEC 60950-1:2005 (Second Edition) + Am 1:2009 + Am 2:2013.</p> <p>When determining the test conclusion, the Measurement Uncertainty of test has been considered.</p> <p>The EMC for Korean deviations is not evaluated.</p> <p>After evaluation, models GT-46050-0505-W2Z representative for test for these models with max. output power.</p> <p>Heating test (4.5): Ta = 40 °C (declared by manufacturer) Tamb = 40 °C Tests were carried out at 90 Va.c. and 264 Va.c.. K-type thermocouple used for temperature measurement.</p>	
<p>Tests performed (name of test and test clause):</p> <ul style="list-style-type: none"> <input checked="" type="checkbox"/> 1. GENERAL <input checked="" type="checkbox"/> 2. PROTECTION FROM HAZARDS <input checked="" type="checkbox"/> 3. WIRING, CONNECTIONS AND SUPPLY <input checked="" type="checkbox"/> 4. PHYSICAL REQUIREMENTS <input checked="" type="checkbox"/> 5. ELECTRICAL REQUIREMENTS AND SIMULATED ABNORMAL CONDITIONS <input type="checkbox"/> 6. CONNECTION TO TELECOMMUNICATION NETWORKS <input type="checkbox"/> 7. CONNECTION TO CABLE DISTRIBUTION SYSTEMS 	<p>Testing location:</p> <p>SGS-CSTC Standards Technical Services (Shanghai) Co., Ltd. 588 West Jindu Road, Xinqiao Town, Songjiang, 201612 Shanghai, China</p>

Summary of compliance with National Differences:

List of countries addressed

1. EU Group Differences (EN 60950-1: 2006 + A11: 2009 + A1: 2010 + A12: 2011+ A2: 2013)
2. EU Special National Conditions: none
3. Compliance with the National requirements of JP (J60950-1(H22)), KR (K60950-1) and AS/NZS (AS/NZS 60950.1:2011 +A1:2012) as given in CB Bulletin was also confirmed.
4. Risk analysis and evaluation for PAHS has been performed (AfPS GS 2014:01 PAK, EK1 374-089 Rev2): see PAHS risk assessment report no. SHES1507004043IT/CHEM
5. CN have not informed its national differences to IEC 60950-1: 2005 (Second Edition) + A1: 2009, the national differences to IEC 60950-1: 2005 have been used.
6. BR had not informed its national differences to IEC 60950-1: 2005 (Second Edition) + A1: 2009 + A2: 2013 in CB Bulletin.

The product fulfils the above requirements.

Copy of marking plate:

The artwork below may be only a draft. The use of certification marks on a product must be authorized by the respective National Certification Body that own these marks.

(Additional requirements for markings. See 1.7 NOTE)

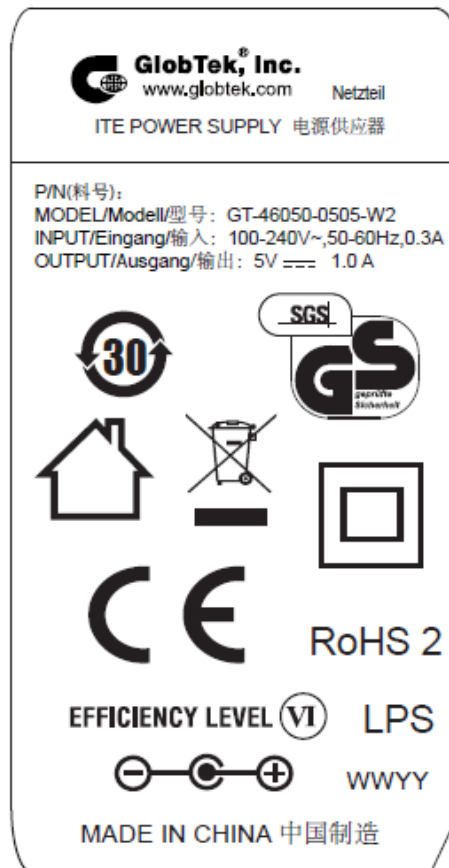

*Remark: The marking for GT-46050-0505-W2 is representative all models of GT-46050-WW05-W2***** Marking for other models are same as above except model name and output parameters.*

Test item particulars.....:	
Equipment mobility.....:	<input type="checkbox"/> movable <input type="checkbox"/> hand-held <input type="checkbox"/> transportable <input type="checkbox"/> stationary <input type="checkbox"/> for building-in <input checked="" type="checkbox"/> direct plug-in
Connection to the mains.....:	<input checked="" type="checkbox"/> pluggable equipment <input checked="" type="checkbox"/> type A <input type="checkbox"/> type B <input type="checkbox"/> permanent connection <input type="checkbox"/> detachable power supply cord <input type="checkbox"/> non-detachable power supply cord <input type="checkbox"/> not directly connected to the mains
Operating condition.....:	<input checked="" type="checkbox"/> continuous <input type="checkbox"/> rated operating / resting time:
Access location	<input checked="" type="checkbox"/> operator accessible <input type="checkbox"/> restricted access location
Over voltage category (OVC)	<input type="checkbox"/> OVC I <input checked="" type="checkbox"/> OVC II <input type="checkbox"/> OVC III <input type="checkbox"/> OVC IV <input type="checkbox"/> other:
Mains supply tolerance (%) or absolute mains supply values	± 10% according to manufacturer
Tested for IT power systems	<input checked="" type="checkbox"/> Yes <input type="checkbox"/> No
IT testing, phase-phase voltage (V)	N/A
Class of equipment	<input type="checkbox"/> Class I <input checked="" type="checkbox"/> Class II <input type="checkbox"/> Class III <input type="checkbox"/> Not classified
Considered current rating of protective device as part of the building installation (A)	16 A
Pollution degree (PD)	<input type="checkbox"/> PD 1 <input checked="" type="checkbox"/> PD 2 <input type="checkbox"/> PD 3
IP protection class	IP20
Altitude during operation (m)	≤ 2000 m
Altitude of test laboratory (m)	≤ 100 m
Mass of equipment (kg)	0,058 kg
Possible test case verdicts:	
- test case does not apply to the test object.....:	N/A
- test object does meet the requirement.....:	P (Pass)
- test object does not meet the requirement.....:	F (Fail)
Testing.....:	
Date of receipt of test item	2015-08-03
Date (s) of performance of tests	2015-08-03 to 2015-08-26
General remarks:	

"(see Enclosure #)" refers to additional information appended to the report.
 "(see appended table)" refers to a table appended to the report.
 Throughout this report a comma is used as the decimal separator.
 This document is issued by the company under its General Conditions of Service accessible at http://www.sgs.com/terms_and_conditions.htm. Attention is drawn to the limitation of liability, indemnification and jurisdiction issues defined there in. Any holder of this document is advised that information contained hereon reflects the Company's findings at the time of its intervention only and within the limits of Client's instructions, if any. The Company's sole responsibility is to its Client and this document does not exonerate parties to a transaction from exercising all their rights and obligations under the transaction documents. Any unauthorized alteration, forgery or falsification of the content or appearance of this document is unlawful and offenders may be prosecuted to the fullest extent of the law.
 Unless otherwise stated: (a) the results shown in this document refer only to the sample(s) tested and (b) such sample(s) are retained for 3 months. This document cannot be reproduced except in full, without prior approval of the company.

Manufacturer's Declaration per sub-clause 4.2.5 of IECCE 02:

The application for obtaining a CB Test Certificate includes more than one factory location and a declaration from the Manufacturer stating that the sample(s) submitted for evaluation is (are) representative of the products from each factory has been provided :	<input checked="" type="checkbox"/> Yes <input type="checkbox"/> Not applicable
---	--

When differences exist; they shall be identified in the General product information section.

Name and address of factory (ies) : Factory inspection:

1, GlobTek (Suzhou) Co.,Ltd.
 Building 4, 76 Jinling East Road, Suzhou Industrial Park, Suzhou, 215021 Jiangsu, China

No Factory inspection:

2, GlobTek, Inc.
 186 Veterans Dr. Northvale, NJ 07647 USA

General product information:

Product name	I.T.E. Power Supply (Switch Mode)
Model	GT-46050-WW05-W2Z***** (Each * = 0-9 or A-Z or ()) or blank for marketing purposes)
Explanation of model designation	WW can be 01,02,03,04,05 denote the output wattage Z designates type of plug and can be E for European plug, U for British plug, blank for North American / Japan plug/Taiwan plug, C for Chinese plug, A for Australia plug Each * = 0-9 or A-Z or ()) or blank for marketing purposes.
Power rating	Input: 100 - 240 V; 50 - 60 Hz; 0,3 A DC-Output: 5 V; Max1,0 A; Max. 5W
Functions	The EUT are Class II switching power adaptors for ITE and designed for continuous operation. They are indoor use only.
Model	All models are identical except for model No. and output ratings

difference

Examples of model name and relevant output ratings.:

Model	wattage
GT-46050-0505-W2	5
GT-46050-0305-W2	3

Abbreviations used in the report:

- | | | | |
|--------------------------------------|-------------|----------------------------|--------------|
| - normal conditions | N.C. | - single fault conditions | S.F.C |
| - functional insulation | OP | - basic insulation | BI |
| - double insulation | DI | - supplementary insulation | SI |
| - between parts of opposite polarity | BOP | - reinforced insulation | RI |

IEC 60950-1			
Clause	Requirement + Test	Result - Remark	Verdict

1	GENERAL		—
---	----------------	--	---

1.5	Components		—
1.5.1	General		P
	Comply with IEC 60950-1 or relevant component standard	(see appended tables 1.5.1)	P
1.5.2	Evaluation and testing of components	<p>Certified components are used in accordance with their ratings, certifications and they comply with applicable parts of this standard.</p> <p>Components not certified are used in accordance with their ratings and they comply with applicable parts of IEC 60950-1 and the relevant component standard.</p> <p>Components, for which no relevant IEC-standard exists, have been tested under the conditions occurring in the equipment, using applicable parts of IEC 60950-1.</p>	P
1.5.3	Thermal controls		N/A
1.5.4	Transformers		P
1.5.5	Interconnecting cables		P
1.5.6	Capacitors bridging insulation	Refer to appended table 1.5.1.	N/A
1.5.7	Resistors bridging insulation		P
1.5.7.1	Resistors bridging functional, basic or supplementary insulation	All resistors are after Fusible Resistor (RF3), there are only functional insulation.	P
1.5.7.2	Resistors bridging double or reinforced insulation between a.c. mains and other circuits		N/A
1.5.7.3	Resistors bridging double or reinforced insulation between a.c. mains and antenna or coaxial cable		N/A
1.5.8	Components in equipment for IT power systems		N/A
1.5.9	Surge suppressors	The VDR (MOV1) are in compliance with Annex Q	P
1.5.9.1	General	A fusible resistor (RF3) is connected in series with the VDR (MOV1)	P
1.5.9.2	Protection of VDRs		P

IEC 60950-1			
Clause	Requirement + Test	Result - Remark	Verdict
1.5.9.3	Bridging of functional insulation by a VDR	Certified VDR (MOV1) connected between line and neutral, located after fuse resistor RF3	P
1.5.9.4	Bridging of basic insulation by a VDR		N/A
1.5.9.5	Bridging of supplementary, double or reinforced insulation by a VDR		N/A

1.6	Power interface		—
1.6.1	AC power distribution systems		P
1.6.2	Input current	(see appended table 1.6.2)	P
1.6.3	Voltage limit of hand-held equipment	Not a hand-held equipment.	N/A
1.6.4	Neutral conductor		P

1.7	Marking and instructions		—
1.7.1	Power rating and identification markings		P
1.7.1.1	Power rating marking		P
	Multiple mains supply connections.....:		N/A
	Rated voltage(s) or voltage range(s) (V)	100 - 240 V	P
	Symbol for nature of supply, for d.c. only		N/A
	Rated frequency or rated frequency range (Hz)	50 - 60 Hz	P
	Rated current (mA or A)	0,3 A	P
1.7.1.2	Identification markings		P
	Manufacturer's name or trade-mark or identification mark	Trade mark :  GlobTek® ,Inc.	P
	Model identification or type reference	GT-46050-WW05-W2Z***** (Each * = 0-9 or A-Z or ()[] or blank for marketing purposes)	P
	Symbol for Class II equipment only	Class II symbol used in label.	P
	Other markings and symbols		P
1.7.1.3	Use of graphical symbols		P
1.7.2	Safety instructions and marking	See below.	P
1.7.2.1	General		P
1.7.2.2	Disconnect devices	Plug	P
1.7.2.3	Overcurrent protective device	Not pluggable equipment type B or permanently connected equipment.	N/A

IEC 60950-1			
Clause	Requirement + Test	Result - Remark	Verdict
1.7.2.4	IT power distribution systems		N/A
1.7.2.5	Operator access with a tool	No tool used for access to operator access area.	N/A
1.7.2.6	Ozone	Not produce ozone.	N/A
1.7.3	Short duty cycles	Equipment is designed for continuous operation.	N/A
1.7.4	Supply voltage adjustment	No voltage adjustment.	N/A
	Methods and means of adjustment; reference to installation instructions		N/A
1.7.5	Power outlets on the equipment	No power outlet.	N/A
1.7.6	Fuse identification (marking, special fusing characteristics, cross-reference)	Provide a fuse resistor: RF3: 10 ohm 1W	P
1.7.7	Wiring terminals		N/A
1.7.7.1	Protective earthing and bonding terminals		N/A
1.7.7.2	Terminals for a.c. mains supply conductors		N/A
1.7.7.3	Terminals for d.c. mains supply conductors		N/A
1.7.8	Controls and indicators		N/A
1.7.8.1	Identification, location and marking		N/A
1.7.8.2	Colours		N/A
1.7.8.3	Symbols according to IEC 60417.....		N/A
1.7.8.4	Markings using figures	No control uses figures.	N/A
1.7.9	Isolation of multiple power sources	No multiple power source.	N/A
1.7.10	Thermostats and other regulating devices	No such device.	N/A
1.7.11	Durability	The marking withstands required tests.	P
1.7.12	Removable parts	No marking placed on removable parts	P
1.7.13	Replaceable batteries		N/A
	Language(s)		—
1.7.14	Equipment for restricted access locations.....		N/A
2	PROTECTION FROM HAZARDS		—
2.1	Protection from electric shock and energy hazards		—
2.1.1	Protection in operator access areas		P
2.1.1.1	Access to energized parts		P

IEC 60950-1			
Clause	Requirement + Test	Result - Remark	Verdict
	Test by inspection	See below.	P
	Test with test finger (Figure 2A)	No access.	P
	Test with test pin (Figure 2B)	No access.	P
	Test with test probe (Figure 2C)	No TNV circuit.	N/A
2.1.1.2	Battery compartments		N/A
2.1.1.3	Access to ELV wiring	No internal wiring at ELV.	N/A
	Working voltage (V_{peak} or V_{rms}); minimum distance through insulation (mm)		—
2.1.1.4	Access to hazardous voltage circuit wiring	All accessible parts are separated from internal wiring at hazardous voltage by double or reinforced insulation.	N/A
2.1.1.5	Energy hazards	No energy hazard in operator access area. Checked by means of the test finger. (see appended table)	P
2.1.1.6	Manual controls	No such part.	N/A
2.1.1.7	Discharge of capacitors in equipment		N/A
	Measured voltage (V); time-constant (s)		—
2.1.1.8	Energy hazards – d.c. mains supply		N/A
	a) Capacitor connected to the d.c. mains supply ..:		N/A
	b) Internal battery connected to the d.c. mains supply :		N/A
2.1.1.9	Audio amplifiers		N/A
2.1.2	Protection in service access areas		N/A
2.1.3	Protection in restricted access locations		N/A

2.2	SELV circuits		—
2.2.1	General requirements		P
2.2.2	Voltages under normal conditions (V)	(see appended table 2.2)	P
2.2.3	Voltages under fault conditions (V)	(see appended table 2.2)	P
2.2.4	Connection of SELV circuits to other circuits	SELV circuits are only connected to other SELV circuits.	P

2.3	TNV circuits		—
2.3.1	Limits	No TNV circuit.	N/A
	Type of TNV circuits		—
2.3.2	Separation from other circuits and from accessible parts		N/A

IEC 60950-1			
Clause	Requirement + Test	Result - Remark	Verdict
2.3.2.1	General requirements		N/A
2.3.2.2	Protection by basic insulation		N/A
2.3.2.3	Protection by earthing		N/A
2.3.2.4	Protection by other constructions		N/A
2.3.3	Separation from hazardous voltages		N/A
	Insulation employed.....		—
2.3.4	Connection of TNV circuits to other circuits		N/A
	Insulation employed.....		—
2.3.5	Test for operating voltages generated externally		N/A

2.4	Limited current circuits		—
2.4.1	General requirements		N/A
2.4.2	Limit values		N/A
	Frequency (Hz).....		—
	Measured current (mA).....		—
	Measured voltage (V)		—
	Measured circuit capacitance (nF or μF).....		—
2.4.3	Connection of limited current circuits to other circuits		N/A

2.5	Limited power sources		—
	a) Inherently limited output		P
	b) Impedance limited output		N/A
	c) Regulating network or IC current limiter, limits output under normal operating and single fault condition	(see appended table 2.5)	P
	Use of integrated circuit (IC) current limiters		N/A
	d) Overcurrent protective device limited output		N/A
	Max. output voltage (V), max. output current (A), max. apparent power (VA).....		—
	Current rating of overcurrent protective device (A) ..		—

2.6	Provisions for earthing and bonding		—
2.6.1	Protective earthing		N/A
2.6.2	Functional earthing		N/A
	Use of symbol for functional earthing		N/A
2.6.3	Protective earthing and protective bonding conductors		N/A

IEC 60950-1			
Clause	Requirement + Test	Result - Remark	Verdict
2.6.3.1	General		N/A
2.6.3.2	Size of protective earthing conductors		N/A
	Rated current (A), cross-sectional area (mm ²), AWG		—
2.6.3.3	Size of protective bonding conductors		N/A
	Rated current (A), cross-sectional area (mm ²), AWG		—
	Protective current rating (A), cross-sectional area (mm ²), AWG		N/A
2.6.3.4	Resistance of earthing conductors and their terminations; resistance (Ω), voltage drop (V), test current (A), duration (min)		N/A
2.6.3.5	Colour of insulation		N/A
2.6.4	Terminals		N/A
2.6.4.1	General		N/A
2.6.4.2	Protective earthing and bonding terminals		N/A
	Rated current (A), type, nominal thread diameter (mm)		—
2.6.4.3	Separation of the protective earthing conductor from protective bonding conductors		N/A
2.6.5	Integrity of protective earthing		N/A
2.6.5.1	Interconnection of equipment		N/A
2.6.5.2	Components in protective earthing conductors and protective bonding conductors		N/A
2.6.5.3	Disconnection of protective earth		N/A
2.6.5.4	Parts that can be removed by an operator		N/A
2.6.5.5	Parts removed during servicing		N/A
2.6.5.6	Corrosion resistance		N/A
2.6.5.7	Screws for protective bonding		N/A
2.6.5.8	Reliance on telecommunication network or cable distribution system		N/A

2.7	Overcurrent and earth fault protection in primary circuits		—
2.7.1	Basic requirements	Protective devices are integrated in equipment.	P
	Instructions when protection relies on building installation	The equipment is pluggable Type A.	N/A
2.7.2	Faults not simulated in 5.3.7		P
2.7.3	Short-circuit backup protection		P
2.7.4	Number and location of protective devices	Only one Fuse resistor in Line	N/A

IEC 60950-1			
Clause	Requirement + Test	Result - Remark	Verdict

2.7.5	Protection by several devices		N/A
2.7.6	Warning to service personnel :		N/A

2.8	Safety interlocks		—
2.8.1	General principles	No safety interlock used.	N/A
2.8.2	Protection requirements		N/A
2.8.3	Inadvertent reactivation		N/A
2.8.4	Fail-safe operation		N/A
	Protection against extreme hazard		N/A
2.8.5	Moving parts		N/A
2.8.6	Overriding		N/A
2.8.7	Switches, relays and their related circuits		N/A
2.8.7.1	Separation distances for contact gaps and their related circuits (mm) :		N/A
2.8.7.2	Overload test		N/A
2.8.7.3	Endurance test		N/A
2.8.7.4	Electric strength test		N/A
2.8.8	Mechanical actuators		N/A

2.9	Electrical insulation		—
2.9.1	Properties of insulating materials	Neither natural rubber, materials containing asbestos nor hygroscopic materials are used as insulation. No driving belts or couplings used.	P
2.9.2	Humidity conditioning	Tested for 120 hrs.	P
	Relative humidity (%), temperature (°C) :	95%, 40 °C	—
2.9.3	Grade of insulation	Insulation is considered to be functional, basic, supplementary, reinforced or double insulation.	P
2.9.4	Separation from hazardous voltages		P
	Method(s) used :	b) (Method 1)	—

2.10	Clearances, creepage distances and distances through insulation		—
-------------	--	--	---

IEC 60950-1			
Clause	Requirement + Test	Result - Remark	Verdict
2.10.1	General	All hazardous voltage parts have been enclosed in power supply unit, which has been certified seperately. All circuits external to the power supply are SELV or protective earth. The insulation is functional.	P
2.10.1.1	Frequency		P
2.10.1.2	Pollution degrees	2	P
2.10.1.3	Reduced values for functional insulation		P
2.10.1.4	Intervening unconnected conductive parts		N/A
2.10.1.5	Insulation with varying dimensions		N/A
2.10.1.6	Special separation requirements		N/A
2.10.1.7	Insulation in circuits generating starting pulses		N/A
2.10.2	Determination of working voltage		P
2.10.2.1	General		P
2.10.2.2	RMS working voltage	(See appended table 2.10.2)	P
2.10.2.3	Peak working voltage	(See appended table 2.10.2)	P
2.10.3	Clearances	(see appended table 2.10.3 and 2.10.4)	P
2.10.3.1	General		P
2.10.3.2	Mains transient voltages		P
	a) AC mains supply	Overvoltage Category II	P
	b) Earthed d.c. mains supplies		N/A
	c) Unearthed d.c. mains supplies		N/A
	d) Battery operation		N/A
2.10.3.3	Clearances in primary circuits	(see appended table 2.10.3 and 2.10.4)	P
2.10.3.4	Clearances in secondary circuits		N/A
2.10.3.5	Clearances in circuits having starting pulses		N/A
2.10.3.6	Transients from a.c. mains supply	Overvoltage category II for secondary circuit and transient voltage 1500Vpeak.	P
2.10.3.7	Transients from d.c. mains supply		N/A
2.10.3.8	Transients from telecommunication networks and cable distribution systems		N/A
2.10.3.9	Measurement of transient voltage levels		N/A
	a) Transients from a mains supply		N/A
	For an a.c. mains supply		N/A
	For a d.c. mains supply		N/A

IEC 60950-1			
Clause	Requirement + Test	Result - Remark	Verdict
	b) Transients from a telecommunication network :		N/A
2.10.4	Creepage distances	(see appended table 2.10.3 and 2.10.4)	P
2.10.4.1	General		P
2.10.4.2	Material group and comparative tracking index		P
	CTI tests	Material group IIIb is assumed to be used.	—
2.10.4.3	Minimum creepage distances	(see appended table 2.10.3 and 2.10.4)	P
2.10.5	Solid insulation		P
2.10.5.1	General		P
2.10.5.2	Distances through insulation	(see appended table 2.10.5)	P
2.10.5.3	Insulating compound as solid insulation		N/A
2.10.5.4	Semiconductor devices		P
2.10.5.5.	Cemented joints		N/A
2.10.5.6	Thin sheet material – General		P
2.10.5.7	Separable thin sheet material	Reinforced insulation.	P
	Number of layers (pcs)	Two layers used, each of which complies with the required electric strength test (see appended table 2.10.5)	—
2.10.5.8	Non-separable thin sheet material		N/A
2.10.5.9	Thin sheet material – standard test procedure		N/A
	Electric strength test		—
2.10.5.10	Thin sheet material – alternative test procedure		P
	Electric strength test	(see appended table 2.10.5)	—
2.10.5.11	Insulation in wound components		P
2.10.5.12	Wire in wound components	Certified source of triple	P
	Working voltage		P
	a) Basic insulation not under stress		N/A
	b) Basic, supplementary, reinforced insulation		N/A
	c) Compliance with Annex U	Triple insulation wire used as secondary winding.	P
	Two wires in contact inside wound component; angle between 45° and 90°	Insulation tube	P
2.10.5.13	Wire with solvent-based enamel in wound components		N/A
	Electric strength test		—
	Routine test		N/A

IEC 60950-1			
Clause	Requirement + Test	Result - Remark	Verdict
2.10.5.14	Additional insulation in wound components		N/A
	Working voltage		N/A
	- Basic insulation not under stress		N/A
	- Supplementary, reinforced insulation		N/A
2.10.6	Construction of printed boards		P
2.10.6.1	Uncoated printed boards	(see appended table 2.10.3 and 2.10.4)	P
2.10.6.2	Coated printed boards		N/A
2.10.6.3	Insulation between conductors on the same inner surface of a printed board		N/A
2.10.6.4	Insulation between conductors on different layers of a printed board		N/A
	Distance through insulation		N/A
	Number of insulation layers (pcs).....		N/A
2.10.7	Component external terminations		N/A
2.10.8	Tests on coated printed boards and coated components		N/A
2.10.8.1	Sample preparation and preliminary inspection		N/A
2.10.8.2	Thermal conditioning		N/A
2.10.8.3	Electric strength test		N/A
2.10.8.4	Abrasion resistance test		N/A
2.10.9	Thermal cycling		N/A
2.10.10	Test for Pollution Degree 1 environment and insulating compound		N/A
2.10.11	Tests for semiconductor devices and cemented joints		N/A
2.10.12	Enclosed and sealed parts		N/A
3	WIRING, CONNECTIONS AND SUPPLY		—
3.1	General		—
3.1.1	Current rating and overcurrent protection	Adequate cross sectional areas on internal wiring.	P
3.1.2	Protection against mechanical damage	The wires are routed away from sharp edges and parts which could damage insulation.	P
3.1.3	Securing of internal wiring	Internal wiring is secured against excessive strain, loosening of terminals and damage to the conductor insulation.	P
3.1.4	Insulation of conductors		P

IEC 60950-1			
Clause	Requirement + Test	Result - Remark	Verdict
3.1.5	Beads and ceramic insulators	No such component.	N/A
3.1.6	Screws for electrical contact pressure		N/A
3.1.7	Insulating materials in electrical connections	No contact pressure through insulating material.	N/A
3.1.8	Self-tapping and spaced thread screws		N/A
3.1.9	Termination of conductors	Terminations cannot become displaced so that clearances and creepage distances can be reduced.	P
	10 N pull test		P
3.1.10	Sleeving on wiring		N/A

3.2	Connection to a mains supply		—
3.2.1	Means of connection		P
3.2.1.1	Connection to an a.c. mains supply	The equipment is provided with appliance inlet.	P
3.2.1.2	Connection to a d.c. mains supply		N/A
3.2.2	Multiple supply connections		N/A
3.2.3	Permanently connected equipment	Not permanently connected equipment.	N/A
	Number of conductors, diameter of cable and conduits (mm)		—
3.2.4	Appliance inlets	Direct plug-in equipment	N/A
3.2.5	Power supply cords	Direct plug-in equipment	N/A
3.2.5.1	AC power supply cords		N/A
	Type		—
	Rated current (A), cross-sectional area (mm ²), AWG		—
3.2.5.2	DC power supply cords		N/A
3.2.6	Cord anchorages and strain relief		N/A
	Mass of equipment (kg), pull (N)		—
	Longitudinal displacement (mm)		—
3.2.7	Protection against mechanical damage	Direct plug-in equipment	N/A
3.2.8	Cord guards		N/A
	Diameter or minor dimension D (mm); test mass (g)		—
	Radius of curvature of cord (mm).....		—
3.2.9	Supply wiring space		N/A

IEC 60950-1			
Clause	Requirement + Test	Result - Remark	Verdict

3.3	Wiring terminals for connection of external conductors		—
3.3.1	Wiring terminals	The equipment is not permanently connected of provided with a non-detachable power supply cord.	N/A
3.3.2	Connection of non-detachable power supply cords		N/A
3.3.3	Screw terminals		N/A
3.3.4	Conductor sizes to be connected		N/A
	Rated current (A), cord/cable type, cross-sectional area (mm ²)		—
3.3.5	Wiring terminal sizes		N/A
	Rated current (A), type, nominal thread diameter (mm)		—
3.3.6	Wiring terminal design		N/A
3.3.7	Grouping of wiring terminals		N/A
3.3.8	Stranded wire		N/A

3.4	Disconnection from the mains supply		—
3.4.1	General requirement		P
3.4.2	Disconnect devices	The plug of direct plug-in is considered to be the disconnect device.	P
3.4.3	Permanently connected equipment	Not permanently connected equipment.	N/A
3.4.4	Parts which remain energized	No parts remain energized after the disconnect device is pull out.	P
3.4.5	Switches in flexible cords	No switch in flexible cord.	N/A
3.4.6	Number of poles - single-phase and d.c. equipment	Disconnect device disconnects both poles simultaneously.	P
3.4.7	Number of poles - three-phase equipment	Single phase equipment.	N/A
3.4.8	Switches as disconnect devices		N/A
3.4.9	Plugs as disconnect devices	The plug of direct plug-in is considered to be the disconnect device.	P
3.4.10	Interconnected equipment	No interconnections using hazardous voltages.	N/A
3.4.11	Multiple power sources		N/A

3.5	Interconnection of equipment		—
-----	------------------------------	--	---

IEC 60950-1			
Clause	Requirement + Test	Result - Remark	Verdict
3.5.1	General requirements		P
3.5.2	Types of interconnection circuits	SELV and LCC circuit	P
3.5.3	ELV circuits as interconnection circuits	No ELV interconnection.	N/A
3.5.4	Data ports for additional equipment		N/A
4	PHYSICAL REQUIREMENTS		—
4.1	Stability		—
	Angle of 10°	Direct plug in equipment.	N/A
	Test force (N)	Not floor-standing equipment.	N/A
4.2	Mechanical strength		—
4.2.1	General		P
	Rack-mounted equipment.		N/A
4.2.2	Steady force test, 10 N	No hazard.	P
4.2.3	Steady force test, 30 N		N/A
4.2.4	Steady force test, 250 N	No hazard.	P
4.2.5	Impact test		N/A
	Fall test		N/A
	Swing test		N/A
4.2.6	Drop test; height (mm)	1000 mm	P
4.2.7	Stress relief test	89 °C; 7 h	P
4.2.8	Cathode ray tubes	No cathode ray tube.	N/A
	Picture tube separately certified		N/A
4.2.9	High pressure lamps	No high pressure lamp.	N/A
4.2.10	Wall or ceiling mounted equipment; force (N)	Not intended to be mounted on a wall or ceiling.	N/A
4.3	Design and construction		—
4.3.1	Edges and corners	All edges and corners are rounded and smoothed.	P
4.3.2	Handles and manual controls; force (N)		N/A
4.3.3	Adjustable controls	No adjustable control.	N/A
4.3.4	Securing of parts		P
4.3.5	Connection by plugs and sockets		N/A
4.3.6	Direct plug-in equipment		P

IEC 60950-1			
Clause	Requirement + Test	Result - Remark	Verdict
	Torque	<p>Less than 0.25 Nm</p> <p>Plug used: US, EU, AU UK and CN plug.</p> <p>1) US plug: The dimension complied with the requirement of ANSI/NEMA WD6 and testing complied with UL1310 as below</p> <p>a) Weight and Moment test: Result: W=58,0g ($\leq 794g$) S=15,8mm X=9,97mm Z=12,75mm WY/Z=73,69g ($\leq 1361g$) WY/S=59,47g ($\leq 1361g$) WX=578.26gm ($\leq 57104gm$)</p> <p>b) Blade securement test Result: Blade 1: 0,01mm Blade 2: 0,01mm Blade 1 and 2: 0,01mm The blades did not loosen by more than 2,4 mm or pull out All testing repeat two times</p> <p>c) Security of Input contacts Result: Blade 1: 0.01mm Blade 2: 0.01mm Both Blades: 0.01mm The blades did not loosen to a degree that would introduce a risk of a fire or an electric shock All testing repeat two times</p> <p>d) Resistance to crushing Result: There was no splitting, cracking or shattering of the enclosure that would expose internal wiring or hazardous live parts</p>	—

IEC 60950-1			
Clause	Requirement + Test	Result - Remark	Verdict
	Compliance with the relevant mains plug standard:	<p>e) Rod pressure: Result: The equipment was connected to 264Vac, 60Hz, during this test, peak voltage and touch current were monitored between earth ground and all parts of the enclosure (the outer foil wrap). Following the test, the sample was subjected to the Electric Strength Test. Max. voltage=26.6Vpk</p> <p>f) The perimeter of the face section from which the blades project do not less than 7.9 mm from any point on either blade Electric Strength tests performed after all tests as above. (see appended table 5.2)</p> <p>2) EU plug: The main plug has been evaluated according to EN50075, Report No. TP-12065 (TP12100042-ETS)</p> <p>3) AU plug: The main plug has been evaluated according to AS/NZS 3112: 2011 + A11 2012, Report No. TP-12064 (TP12100040-ETS)</p> <p>4) UK plug: The main plug has been evaluated according to BS 1361-1: 1995 + A1: 1997 + A2: 2003+ A3: 2007+ A4: 2012, Report No. TP-12066 (TP12100043-ETS)</p> <p>5) CN plug: The plug have to be Checked The plug have to be checked during national approval</p>	P

IEC 60950-1			
Clause	Requirement + Test	Result - Remark	Verdict
4.3.7	Heating elements in earthed equipment		N/A
4.3.8	Batteries		N/A
	- Overcharging of a rechargeable battery		N/A
	- Unintentional charging of a non-rechargeable battery		N/A
	- Reverse charging of a rechargeable battery		N/A
	- Excessive discharging rate for any battery		N/A
4.3.9	Oil and grease	No oil and grease.	N/A
4.3.10	Dust, powders, liquids and gases	Not intend to product dust, or using powders, liquids and gases.	N/A
4.3.11	Containers for liquids or gases	No such containers used.	N/A
4.3.12	Flammable liquids	No flammable liquids.	N/A
	Quantity of liquid (l)		N/A
	Flash point (°C)		N/A
4.3.13	Radiation		N/A
4.3.13.1	General		N/A
4.3.13.2	Ionizing radiation	No ionizing radiation.	N/A
	Measured radiation (pA/kg)		—
	Measured high-voltage (kV)		—
	Measured focus voltage (kV)		—
	CRT markings		—
4.3.13.3	Effect of ultraviolet (UV) radiation on materials	No UV lamp used.	N/A
	Part, property, retention after test, flammability classification		N/A
4.3.13.4	Human exposure to ultraviolet (UV) radiation	No UV radiation.	N/A
4.3.13.5	Lasers (including laser diodes) and LEDs		N/A
4.3.13.5.1	Lasers (including laser diodes)		N/A
	Laser class		—
4.3.13.5.2	Light emitting diodes (LEDs)		N/A
4.3.13.6	Other types		N/A
4.4	Protection against hazardous moving parts		—
4.4.1	General	No moving parts.	N/A
4.4.2	Protection in operator access areas		N/A
	Household and home/office document/media shredders		N/A
4.4.3	Protection in restricted access locations		N/A

IEC 60950-1			
Clause	Requirement + Test	Result - Remark	Verdict
4.4.4	Protection in service access areas		N/A
4.4.5	Protection against moving fan blades		N/A
4.4.5.1	General		N/A
	Not considered to cause pain or injury. a).....:		N/A
	Is considered to cause pain, not injury. b)		N/A
	Considered to cause injury. c)		N/A
4.4.5.2	Protection for users		N/A
	Use of symbol or warning		N/A
4.4.5.3	Protection for service persons		N/A
	Use of symbol or warning		N/A

4.5	Thermal requirements		—
4.5.1	General		P
4.5.2	Temperature tests		P
	Normal load condition per Annex L	Rated load with continuous operation.	—
4.5.3	Temperature limits for materials	(see appended table 4.5)	P
4.5.4	Touch temperature limits	(see appended table 4.5)	P
4.5.5	Resistance to abnormal heat	(see appended table 4.5.5)	P

4.6	Openings in enclosures		—
4.6.1	Top and side openings	No opening in the equipment.	P
	Dimensions (mm)		—
4.6.2	Bottoms of fire enclosures	No opening in the equipment.	P
	Construction of the bottom, dimensions (mm) ..		—
4.6.3	Doors or covers in fire enclosures	No cover can be removed by hand.	N/A
4.6.4	Openings in transportable equipment		N/A
4.6.4.1	Constructional design measures		N/A
	Dimensions (mm)		—
4.6.4.2	Evaluation measures for larger openings		N/A
4.6.4.3	Use of metallized parts		N/A
4.6.5	Adhesives for constructional purposes		N/A
	Conditioning temperature (°C), time (weeks)		—

4.7	Resistance to fire		—
4.7.1	Reducing the risk of ignition and spread of flame		P

IEC 60950-1			
Clause	Requirement + Test	Result - Remark	Verdict
	Method 1, selection and application of components wiring and materials	(See appended table 4.7)	P
	Method 2, application of all of simulated fault condition tests		N/A
4.7.2	Conditions for a fire enclosure		P
4.7.2.1	Parts requiring a fire enclosure	The fire enclosure covers all parts.	P
4.7.2.2	Parts not requiring a fire enclosure		N/A
4.7.3	Materials		P
4.7.3.1	General	Components and materials have adequate flammability classification. See appended table 1.5.1.	P
4.7.3.2	Materials for fire enclosures	The fire enclosure is V-1 material.	P
4.7.3.3	Materials for components and other parts outside fire enclosures	No parts outside the fire enclosure.	N/A
4.7.3.4	Materials for components and other parts inside fire enclosures		P
4.7.3.5	Materials for air filter assemblies	No air filter.	N/A
4.7.3.6	Materials used in high-voltage components	No high-voltage component.	N/A

5	ELECTRICAL REQUIREMENTS AND SIMULATED ABNORMAL CONDITIONS		—
5.1	Touch current and protective conductor current		—
5.1.1	General	(see appended Table 5.1)	P
5.1.2	Configuration of equipment under test (EUT)		P
5.1.2.1	Single connection to an a.c. mains supply		P
5.1.2.2	Redundant multiple connections to an a.c. mains supply		N/A
5.1.2.3	Simultaneous multiple connections to an a.c. mains supply		N/A
5.1.3	Test circuit		P
5.1.4	Application of measuring instrument	Measuring instrument D1 is used.	P
5.1.5	Test procedure		P
5.1.6	Test measurements		P
	Supply voltage (V)	(see appended table 5.1)	—
	Measured touch current (mA)	(see appended table 5.1)	—
	Max. allowed touch current (mA)	(see appended table 5.1)	—
	Measured protective conductor current (mA)		—

IEC 60950-1			
Clause	Requirement + Test	Result - Remark	Verdict
	Max. allowed protective conductor current (mA)....:		—
5.1.7	Equipment with touch current exceeding 3,5 mA		N/A
5.1.7.1	General		N/A
5.1.7.2	Simultaneous multiple connections to the supply		N/A
5.1.8	Touch currents to telecommunication networks and cable distribution systems and from telecommunication networks	No TNV circuit provided	N/A
5.1.8.1	Limitation of the touch current to a telecommunication network or to a cable distribution system		N/A
	Supply voltage (V)		—
	Measured touch current (mA)		—
	Max. allowed touch current (mA)		—
5.1.8.2	Summation of touch currents from telecommunication networks		N/A
	a) EUT with earthed telecommunication ports		N/A
	b) EUT whose telecommunication ports have no reference to protective earth		N/A

5.2	Electric strength		—
5.2.1	General	(see appended table 5.2)	P
5.2.2	Test procedure	(see appended table 5.2)	P

5.3	Abnormal operating and fault conditions		—
5.3.1	Protection against overload and abnormal operation	(see appended table 5.3)	P
5.3.2	Motors	No motors.	N/A
5.3.3	Transformers	See Annex C and appended table C.2.	P
5.3.4	Functional insulation.....:	Complies with a), b) and c).	P
5.3.5	Electromechanical components	No such components.	N/A
5.3.6	Audio amplifiers in ITE	No audio amplifier.	N/A
5.3.7	Simulation of faults	(see appended table 5.3)	P
5.3.8	Unattended equipment		N/A
5.3.9	Compliance criteria for abnormal operating and fault conditions	No fire or molten metal occurred and no deformation of enclosure during the tests.	P
5.3.9.1	During the tests	No fire or molten metal occurred and no deformation of enclosure during the tests.	P

IEC 60950-1			
Clause	Requirement + Test	Result - Remark	Verdict
5.3.9.2	After the tests	Electric strength test made.	P
6	CONNECTION TO TELECOMMUNICATION NETWORKS		—
6.1	Protection of telecommunication network service persons, and users of other equipment connected to the network, from hazards in the equipment		—
6.1.1	Protection from hazardous voltages		N/A
6.1.2	Separation of the telecommunication network from earth		N/A
6.1.2.1	Requirements		N/A
	Supply voltage (V)		—
	Current in the test circuit (mA)		—
6.1.2.2	Exclusions		N/A
6.2	Protection of equipment users from overvoltages on telecommunication networks		—
6.2.1	Separation requirements		N/A
6.2.2	Electric strength test procedure		N/A
6.2.2.1	Impulse test		N/A
6.2.2.2	Steady-state test		N/A
6.2.2.3	Compliance criteria		N/A
6.3	Protection of the telecommunication wiring system from overheating		—
	Max. output current (A)		—
	Current limiting method		—
7	CONNECTION TO CABLE DISTRIBUTION SYSTEMS		—
7.1	General		N/A
7.2	Protection of cable distribution system service persons, and users of other equipment connected to the system, from hazardous voltages in the equipment		N/A
7.3	Protection of equipment users from overvoltages on the cable distribution system		N/A
7.4	Insulation between primary circuits and cable distribution systems		N/A
7.4.1	General		N/A
7.4.2	Voltage surge test		N/A
7.4.3	Impulse test		N/A
A	ANNEX A, TESTS FOR RESISTANCE TO HEAT AND FIRE		—

IEC 60950-1			
Clause	Requirement + Test	Result - Remark	Verdict
A.1	Flammability test for fire enclosures of movable equipment having a total mass exceeding 18 kg, and of stationary equipment (see 4.7.3.2)		N/A
A.1.1	Samples.....:		—
	Wall thickness (mm)		—
A.1.2	Conditioning of samples; temperature (°C)		N/A
A.1.3	Mounting of samples		N/A
A.1.4	Test flame (see IEC 60695-11-3)		N/A
	Flame A, B, C or D		—
A.1.5	Test procedure		N/A
A.1.6	Compliance criteria		N/A
	Sample 1 burning time (s)		—
	Sample 2 burning time (s)		—
	Sample 3 burning time (s)		—
A.2	Flammability test for fire enclosures of movable equipment having a total mass not exceeding 18 kg, and for material and components located inside fire enclosures (see 4.7.3.2 and 4.7.3.4)		N/A
A.2.1	Samples, material.....:		—
	Wall thickness (mm)		—
A.2.2	Conditioning of samples; temperature (°C)		N/A
A.2.3	Mounting of samples		N/A
A.2.4	Test flame (see IEC 60695-11-4)		N/A
	Flame A, B or C		—
A.2.5	Test procedure		N/A
A.2.6	Compliance criteria		N/A
	Sample 1 burning time (s)		—
	Sample 2 burning time (s)		—
	Sample 3 burning time (s)		—
A.2.7	Alternative test acc. to IEC 60695-11-5, cl. 5 and 9		N/A
	Sample 1 burning time (s)		—
	Sample 2 burning time (s)		—
	Sample 3 burning time (s)		—
A.3	Hot flaming oil test (see 4.6.2)		N/A
A.3.1	Mounting of samples		N/A
A.3.2	Test procedure		N/A
A.3.3	Compliance criterion		N/A

IEC 60950-1			
Clause	Requirement + Test	Result - Remark	Verdict

B	ANNEX B, MOTOR TESTS UNDER ABNORMAL CONDITIONS (see 4.7.2.2 and 5.3.2)		—
B.1	General requirements		N/A
	Position		—
	Manufacturer		—
	Type		—
	Rated values		—
B.2	Test conditions		N/A
B.3	Maximum temperatures		N/A
B.4	Running overload test		N/A
B.5	Locked-rotor overload test		N/A
	Test duration (days)		—
	Electric strength test: test voltage (V)		—
B.6	Running overload test for d.c. motors in secondary circuits		N/A
B.6.1	General		N/A
B.6.2	Test procedure		N/A
B.6.3	Alternative test procedure		N/A
B.6.4	Electric strength test; test voltage (V)		N/A
B.7	Locked-rotor overload test for d.c. motors in secondary circuits		N/A
B.7.1	General		N/A
B.7.2	Test procedure		N/A
B.7.3	Alternative test procedure		N/A
B.7.4	Electric strength test; test voltage (V)		N/A
B.8	Test for motors with capacitors		N/A
B.9	Test for three-phase motors		N/A
B.10	Test for series motors		N/A
	Operating voltage (V)		—

C	ANNEX C, TRANSFORMERS (see 1.5.4 and 5.3.3)		—
	Position	T1: Primary to secondary.	—
	Manufacturer	(See appended table 1.5.1)	—
	Type	(See appended table 1.5.1)	—
	Rated values	(See appended table 1.5.1)	—
	Method of protection	Inherent protection	—

IEC 60950-1			
Clause	Requirement + Test	Result - Remark	Verdict
C.1	Overload test	(See appended table 5.3)	P
C.2	Insulation	(see appended tables 5.2 and C2)	P
	Protection from displacement of windings..... :	(see appended table C.2)	P
D	ANNEX D, MEASURING INSTRUMENTS FOR TOUCH-CURRENT TESTS (see 5.1.4)		—
D.1	Measuring instrument	Figure D.1 used.	P
D.2	Alternative measuring instrument		N/A
E	ANNEX E, TEMPERATURE RISE OF A WINDING (see 1.4.13)		—
F	ANNEX F, MEASUREMENT OF CLEARANCES AND CREEPAGE DISTANCES (see 2.10 and Annex G)		—
G	ANNEX G, ALTERNATIVE METHOD FOR DETERMINING MINIMUM CLEARANCES		—
G.1	Clearances		N/A
G.1.1	General		N/A
G.1.2	Summary of the procedure for determining minimum clearances		N/A
G.2	Determination of mains transient voltage (V)		N/A
G.2.1	AC mains supply		N/A
G.2.2	Earthed d.c. mains supplies		N/A
G.2.3	Unearthed d.c. mains supplies		N/A
G.2.4	Battery operation		N/A
G.3	Determination of telecommunication network transient voltage (V)		N/A
G.4	Determination of required withstand voltage (V)		N/A
G.4.1	Mains transients and internal repetitive peaks		N/A
G.4.2	Transients from telecommunication networks		N/A
G.4.3	Combination of transients		N/A
G.4.4	Transients from cable distribution systems		N/A
G.5	Measurement of transient voltages (V)		N/A
	a) Transients from a mains supply		N/A
	For an a.c. mains supply		N/A
	For a d.c. mains supply		N/A
	b) Transients from a telecommunication network		N/A

IEC 60950-1			
Clause	Requirement + Test	Result - Remark	Verdict
G.6	Determination of minimum clearances :		N/A
H	ANNEX H, IONIZING RADIATION (see 4.3.13)		—
J	ANNEX J, TABLE OF ELECTROCHEMICAL POTENTIALS (see 2.6.5.6)		—
	Metal(s) used		—
K	ANNEX K, THERMAL CONTROLS (see 1.5.3 and 5.3.8)		—
K.1	Making and breaking capacity		N/A
K.2	Thermostat reliability; operating voltage (V)		N/A
K.3	Thermostat endurance test; operating voltage (V)		N/A
K.4	Temperature limiter endurance; operating voltage (V)		N/A
K.5	Thermal cut-out reliability		N/A
K.6	Stability of operation		N/A
L	ANNEX L, NORMAL LOAD CONDITIONS FOR SOME TYPES OF ELECTRICAL BUSINESS EQUIPMENT (see 1.2.2.1 and 4.5.2)		—
L.1	Typewriters		N/A
L.2	Adding machines and cash registers		N/A
L.3	Erasers		N/A
L.4	Pencil sharpeners		N/A
L.5	Duplicators and copy machines		N/A
L.6	Motor-operated files		N/A
L.7	Other business equipment		P
M	ANNEX M, CRITERIA FOR TELEPHONE RINGING SIGNALS (see 2.3.1)		—
M.1	Introduction		N/A
M.2	Method A		N/A
M.3	Method B		N/A
M.3.1	Ringling signal		N/A
M.3.1.1	Frequency (Hz)		—
M.3.1.2	Voltage (V)		—
M.3.1.3	Cadence; time (s), voltage (V)		—
M.3.1.4	Single fault current (mA)		—
M.3.2	Tripping device and monitoring voltage		N/A

IEC 60950-1			
Clause	Requirement + Test	Result - Remark	Verdict
M.3.2.1	Conditions for use of a tripping device or a monitoring voltage		N/A
M.3.2.2	Tripping device		N/A
M.3.2.3	Monitoring voltage (V)		N/A
N	ANNEX N, IMPULSE TEST GENERATORS (see 1.5.7.2, 1.5.7.3, 2.10.3.9, 6.2.2.1, 7.3.2, 7.4.3 and Clause G.5)		—
N.1	ITU-T impulse test generators		N/A
N.2	IEC 60065 impulse test generator		N/A
P	ANNEX P, NORMATIVE REFERENCES		—
Q	ANNEX Q, Voltage dependent resistors (VDRs) (see 1.5.9.1)		—
	- Preferred climatic categories	Certified VDR used. (see appended table 1.5.1)	P
	- Maximum continuous voltage	Certified VDR used. (see appended table 1.5.1)	P
	- Combination pulse current	Certified VDR used. (see appended table 1.5.1)	P
	Body of the VDR Test according to IEC60695-11-5.....		P
	Body of the VDR. Flammability class of material (min V-1).....		P
R	ANNEX R, EXAMPLES OF REQUIREMENTS FOR QUALITY CONTROL PROGRAMMES		—
R.1	Minimum separation distances for unpopulated coated printed boards (see 2.10.6.2)		N/A
R.2	Reduced clearances (see 2.10.3)		N/A
S	ANNEX S, PROCEDURE FOR IMPULSE TESTING (see 6.2.2.3)		—
S.1	Test equipment		N/A
S.2	Test procedure		N/A
S.3	Examples of waveforms during impulse testing		N/A
T	ANNEX T, GUIDANCE ON PROTECTION AGAINST INGRESS OF WATER (see 1.1.2)		—
			—

IEC 60950-1			
Clause	Requirement + Test	Result - Remark	Verdict
U	ANNEX U, INSULATED WINDING WIRES FOR USE WITHOUT INTERLEAVED INSULATION (see 2.10.5.4)		—
		The TIW of T1 was certified by UL.	—
V	ANNEX V, AC POWER DISTRIBUTION SYSTEMS (see 1.6.1)		—
V.1	Introduction	IT and TN	P
V.2	TN power distribution systems		P
W	ANNEX W, SUMMATION OF TOUCH CURRENTS		—
W.1	Touch current from electronic circuits		N/A
W.1.1	Floating circuits		N/A
W.1.2	Earthed circuits		N/A
W.2	Interconnection of several equipments		N/A
W.2.1	Isolation		N/A
W.2.2	Common return, isolated from earth		N/A
W.2.3	Common return, connected to protective earth		N/A
X	ANNEX X, MAXIMUM HEATING EFFECT IN TRANSFORMER TESTS (see clause C.1)		—
X.1	Determination of maximum input current		P
X.2	Overload test procedure		P
Y	ANNEX Y, ULTRAVIOLET LIGHT CONDITIONING TEST (see 4.3.13.3)		—
Y.1	Test apparatus		N/A
Y.2	Mounting of test samples		N/A
Y.3	Carbon-arc light-exposure apparatus		N/A
Y.4	Xenon-arc light exposure apparatus		N/A
Z	ANNEX Z, OVERVOLTAGE CATEGORIES (see 2.10.3.2 and Clause G.2)		—
AA	ANNEX AA, MANDREL TEST (see 2.10.5.8)		—
BB	ANNEX BB, CHANGES IN THE SECOND EDITION		—
CC	ANNEX CC, Evaluation of integrated circuit (IC) current limiters		—
CC.1	General		N/A

IEC 60950-1			
Clause	Requirement + Test	Result - Remark	Verdict
CC.2	Test program 1.....:		N/A
CC.3	Test program 2.....:		N/A
CC.4	Test program 3.....:		N/A
CC.5	Compliance.....:		N/A
DD	ANNEX DD, Requirements for the mounting means of rack-mounted equipment		—
DD.1	General		N/A
DD.2	Mechanical strength test, variable N.....:		N/A
DD.3	Mechanical strength test, 250N, including end stops.....:		N/A
DD.4	Compliance.....:		N/A
EE	ANNEX EE, Household and home/office document/media shredders		—
EE.1	General		N/A
EE.2	Markings and instructions		N/A
	Use of markings or symbols.....:		N/A
	Information of user instructions, maintenance and/or servicing instructions.....:		N/A
EE.3	Inadvertent reactivation test.....:		N/A
EE.4	Disconnection of power to hazardous moving parts:		N/A
	Use of markings or symbols.....:		N/A
EE.5	Protection against hazardous moving parts		N/A
	Test with test finger (Figure 2A)		N/A
	Test with wedge probe (Figure EE1 and EE2)		N/A

IEC 60950-1			
Clause	Requirement + Test	Result - Remark	Verdict

1.5.1	TABLE: List of critical components					P
Object/part No.	Manufacturer/ trademark	Type/model	Technical data	Standard (Edition / year)	Mark(s) of conformity ¹⁾	
Plastic Enclosure	SABIC Innovative Plastics	SE1X(GG)(f1) 945	Min. V-1, min. 1,7 mm thickness, 105 °C	UL94	UL	
PCB	Interchangeable	Interchangeable	Min. V-0, min. 130 °C	--	UL	
Fusible resistor (RF3)	Great Electronics Co. Ltd.	RXF-1W	10 Ω , 1W	UL 1412	UL	
Alternative	Aahui Changsheng Electronics CO LTD	RXF21-1W	10 Ω , 1W	UL 1412	UL	
Varistor (MOV1) (optional)	Centra Science Corp.	CNR-14V511K, CNR-14D511K	320Vac, 410Vdc, (Flame class of body coating complied with V-0)	IEC 61051-1, IEC 61051-2, IEC 61051-2-2, UL 1449 3rd SPD type 3 approved	VDE, UL	
Alternative	Centra Science Corp.	CNR-10V471K, CNR-14D471K	300Vac, 385Vdc, (Flame class of body coating complied with V-0)	IEC 61051-1, IEC 61051-2, IEC 61051-2-2, UL 1449 3rd SPD type 3 approved	VDE, UL	
Alternative	Joyin Co Ltd	10N511K, 14N511K, 14S511K	320Vac, 418Vdc, (Flame class of body coating complied with V-0)	IEC 61051-1, IEC 61051-2, IEC 61051-2-2, UL 1449 3rd, IEC 60950-1:2005, Annex Q.	VDE, UL	

IEC 60950-1					
Clause	Requirement + Test			Result - Remark	Verdict
Alternative	Joyin Co Ltd	14N471K, 10N471K	300Vac, 385Vdc, (Flame class of body coating complied with V- 0)	IEC 61051-1, IEC 61051-2, IEC 61051-2-2, UL 1449 3rd, IEC 60950- 1:2005, Annex Q.	VDE, UL
Alternative	Thinking Electronicl ndustrial Co Ltd	TVR 14471, TVR 10471-V	300Vac, 385Vdc, (Flame class of body coating complied with V- 0)	IEC 61051-1, IEC 61051-2, IEC 61051-2-2, UL 1449 3rd, IEC 60950- 1:2005, Annex Q.	VDE, UL
Alternative	Thinking Electronicl ndustrial Co Ltd	TVR 1471 (for VDE), TVR 10471K (for UL)	300Vac, 385Vdc, (Flame class of body coating complied with V- 0)	IEC 61051-1, IEC 61051-2, IEC 61051-2-2, UL 1449 3rd SPD type 3 approved	VDE, UL
Alternative	Thinking Electronicl ndustrial Co Ltd	TVR 14511	320Vac, 410Vdc, (Flame class of body coating complied with V- 0)	IEC 61051-1, IEC 61051-2, IEC 61051-2-2, UL 1449 3rd, IEC 60950- 1:2005, Annex Q.	VDE, UL
Alternative	Thinking Electronic Industrial Co Ltd	TVR10511 (for VDE), TVR 10511K (for UL)	320Vac, 410Vdc, (Flame class of body coating complied with V- 0)	IEC 61051-1, IEC 61051-2, IEC 61051-2-2, UL 1449 3rd SPD type 3 approved	VDE, UL

IEC 60950-1					
Clause	Requirement + Test			Result - Remark	Verdict
Alternative	Ceramate Technical Co Ltd	GNR 14D511K	320Vac, 410Vdc, (Flame class of body coating complied with V-0)	IEC 61051-1, IEC 61051-2, IEC 61051-2-2, UL 1449 3rd SPD type 3 approved	VDE, UL
Alternative	Ceramate Technical Co Ltd	GNR 14D471K, GNR10D471K	300Vac, 385Vdc, (Flame class of body coating complied with V-0)	IEC 61051-1, IEC 61051-2, IEC 61051-2-2, UL 1449 3rd SPD type 3 approved	VDE, UL
Alternative	Success Electronics Co Ltd	SVR10D471K, SVR14D471K	300Vac, 385Vdc, (Flame class of body coating complied with V-0)	IEC 61051-1, IEC 61051-2, IEC 61051-2-2, UL 1449 3rd SPD type 3 approved	VDE, UL
Alternative	Success Electronics Co Ltd	SVR14D511K, SVR10D511K	320Vac, 415Vdc, (Flame class of body coating complied with V-0)	VIEC 61051-1, IEC 61051-2, IEC 61051-2-2, UL 1449 3rd SPD type 3 approved	VDE, UL
Transformer (T1)	Electric Co Ltd or GLOBTEK/BOA M/HAOPUWEI	XF00865	Class B	IEC 60950-1:2005 + A1 + A2 EN 60950-1: 2006 + A11 + A1 + A12+ A2	Tested with appliance
Bobbin	Chang Chun Plastics Co Ltd	T375J , T375HF	Phenolic, V-0, min. thickness 0.71 mm, 150 °C	--	UL
Alternative	Sumitomo Bakelite Co Ltd	PM-9820	V-0; 150 °C; PHENOLIC	--	UL

IEC 60950-1					
Clause	Requirement + Test			Result - Remark	Verdict
Tape	3M Company Electrical Markets DIV (EMD)	1350F-(#), 1350T-1	130 °C	--	UL
Alternative	Bondtec Pacific Co Ltd	370S	130 °C	--	UL
Triple Insulated wire (Used in T1)	Great Leoflon Industrial Co Ltd	TRW(B) series	130 °C	IEC/EN 60950- 1, UL 2353	VDE, UL
Wire	Interchangeable	Interchangeable	130 °C	--	UL
Supplementary information: 1) Provided evidence ensures the agreed level of compliance. See OD-CB2039. 2) For all transformers under all manufactures.					

IEC 60950-1			
Clause	Requirement + Test	Result - Remark	Verdict

1.5.1	TABLE: Opto Electronic Devices	N/A
Manufacturer : --		
Type..... : --		
Separately tested : --		
Bridging insulation : --		
External creepage distance..... : --		
Internal creepage distance : --		
Distance through insulation : --		
Tested under the following conditions..... : --		
Input..... : --		
Output..... : --		
supplementary information		
--		

IEC 60950-1			
Clause	Requirement + Test	Result - Remark	Verdict

1.6.2	TABLE: Electrical data (in normal conditions)						P
U (V)	I (A)	I _{rated} (A)	P (W)	Fuse #	I _{fuse} (A)	Condition/status	
90/50Hz	0,122	--	6,8	RF3	0,122	Loaded with 5 V / 1,0 A.	
100/50Hz	0,111	0,3	6,8	RF3	0,111	Loaded with 5 V / 1,0 A.	
240/50Hz	0,063	0,3	6,6	RF3	0,063	Loaded with 5 V / 1,0 A.	
254/50Hz	0,060	--	6,7	RF3	0,060	Loaded with 5 V / 1,0 A.	
264/50Hz	0,058	--	6,6	RF3	0,058	Loaded with 5 V / 1,0 A.	
90/60Hz	0,124	--	6,8	RF3	0,124	Loaded with 5 V / 1,0 A.	
100/60Hz	0,113	0,3	6,8	RF3	0,113	Loaded with 5 V / 1,0 A.	
240/60Hz	0,063	0,3	6,6	RF3	0,063	Loaded with 5 V / 1,0 A.	
254/60Hz	0,061	--	6,6	RF3	0,061	Loaded with 5 V / 1,0 A.	
264/60Hz	0,059	--	6,7	RF3	0,059	Loaded with 5 V / 1,0 A.	
Supplementary information:							

2.1.1.5 c) 1)	TABLE: max. V, A, VA test					P
Voltage (rated) (Vd.c.)	Current (rated) (A)	Voltage (max.) (V)	Current (max.) (A)	VA (max.) (VA)		
5	1,0	4,87	1,2	5,8		
supplementary information:						
The above measurements are the maximum values (max. V and max. A not obtained at the same time).						

2.1.1.5 c) 2)	TABLE: stored energy			N/A
Capacitance C (μF)	Voltage U (V)		Energy E (J)	
--	--		--	
supplementary information:				

2.2	TABLE: evaluation of voltage limiting components in SELV circuits			P
Component (measured between)	max. voltage (V) (normal operation)		Voltage Limiting Components	
	V peak	V d.c.		
T1 (7-RTN)	28,2	--	--	
Fault test performed on voltage limiting components		Voltage measured (V) in SELV circuits (V peak or V d.c.)		

IEC 60950-1			
Clause	Requirement + Test	Result - Remark	Verdict

supplementary information:

--

2.5	TABLE: Limited power sources	P
------------	-------------------------------------	---

Circuit output tested:

Note: Measured Uoc (V) with all load circuits disconnected:

Components	Test condition (Single fault)	Uoc (Vd.c.)	I _{sc} (A)		VA	
			Meas.	Limit	Meas.	Limit
Output	Normal condition	5,0	1,19	8	5,8	100
Output	Oc RS6	5,0	1,2	8	5,8	100
Output	Sc RS9	0,1	0	8	0	100

supplementary information:

- 1) Unit shut down;
- 2) Oc= open circuit, Sc = short circuit.

IEC 60950-1			
Clause	Requirement + Test	Result - Remark	Verdict

2.10.2	Table: working voltage measurement			P
Location	RMS voltage (V)	Peak voltage (V)	Comments	
T1 (1-6, RTN)	177	344	--	
T1 (1-7)	167	336	--	
T1 (2-6, RTN)	206	472	Max RMS & Peak	
T1 (2-7)	204	472	--	
T1 (3-6, RTN)	186	360	--	
T1 (3-7)	191	372	--	
T1 (5-6, RTN)	190	428	--	
T1 (5-7)	194	432	--	
T1 (6)-CS2	184	360		
T1 (7)-CS2	185	364		
T1 (6)-RS11	176	348		
supplementary information:				
--				

2.10.3 and 2.10.4	TABLE: Clearance and creepage distance measurements						P
Clearance (cl) and creepage distance (cr) at/of/between:	U peak (V)	U r.m.s. (V)	Required cl (mm) ⁵⁾	cl (mm)	Required cr (mm)	cr (mm)	
Functional:							
Between fusible resistor (RF3) trace	420	250	1,5	13,9	2,5	13,9	
Traces of L and N before fusible resistor (RF3)	420	250	1,5	10,3	2,5	10,3	
Basic/supplementary:							
--	--	--	--	--	--	--	
Reinforced:							
Primary components → secondary components	420	250	4,0	See as below	5,0	See as below	
Line wire → outer of enclosure (user accessible)	420	250	4,0	9,6	5,0	9,6	

IEC 60950-1						
Clause	Requirement + Test			Result - Remark		Verdict
Neutral pin (behind the replaceable plug module → outer of enclosure (user accessible))	420	250	4,0	8,2	5,0	8,2
T1 core → C3 (without tape of around core of T1)	472	250	4,2	6,9	5,0	6,9
Primary trace → secondary trace	472	250	4,2	4,3	5,0	5,5
DS1 → CS6 trace	472	250	4,2	6,8	5,0	6,8
T1 (6) → CS2 trace	472	250	4,2	4,3	5,0	5,5
Supplementary information: --						

2.10.5	TABLE: Distance through insulation measurements					P
Distance through insulation (DTI) at/of:	U peak (V)	U rms (V)	Test voltage (V)	Required DTI (mm)	DTI (mm)	
Polyester tape (One layer for testing) Material used: 1) 3M type 1350F-(#) 2) 3M type 1350T-1 3) Bondtec Pacific type 370S)	472	250	3000V _a c	--	Two layers	
Plastic enclosure Material used: 1) SABIC Type SE1X(GG)(f1)	472	250	3000V _a c	0,4	1,7	
Supplementary information:--						

IEC 60950-1										
Clause	Requirement + Test			Result - Remark				Verdict		
4.3.8	TABLE: Batteries								N/A	
The tests of 4.3.8 are applicable only when appropriate battery data is not available				--				N/A		
Is it possible to install the battery in a reverse polarity position?				--				N/A		
	Non-rechargeable batteries			Rechargeable batteries						
	Discharging		Un-intentional charging	Charging		Discharging		Reversed charging		
	Meas. current	Manuf. Specs.		Meas. current	Manuf. Specs.	Meas. current	Manuf. Specs.	Meas. current	Manuf. Specs.	
Max. current during normal condition	--	--	--	--	--	--	--	--	--	
Max. current during fault condition	--	--	--	--	--	--	--	--	--	
Test results:								Verdict		
- Chemical leaks				--				--		
- Explosion of the battery				--				--		
- Emission of flame or expulsion of molten metal				--				--		
- Electric strength tests of equipment after completion of tests				--				--		
Supplementary information:										

IEC 60950-1			
Clause	Requirement + Test	Result - Remark	Verdict

4.3.8	TABLE: Batteries	N/A
Battery category : -- Manufacturer : -- Type / model..... : -- Voltage : -- Capacity..... : -- Tested and Certified by (incl. Ref. No.) : -- Circuit protection diagram: -- --		

MARKINGS AND INSTRUCTIONS (1.7.13)	
Location of replaceable battery	--
Language(s)	--
Close to the battery	--
In the servicing instructions	--
In the operating instructions	--

IEC 60950-1			
Clause	Requirement + Test	Result - Remark	Verdict

4.5	TABLE: Thermal requirements						P
	Supply voltage (V)	90V/ 60Hz	90V/ 60Hz	264V/ 60Hz	264V/ 60Hz	—	—
	Ambient T _{min} (°C)	40	40	40	40	—	—
	Ambient T _{max} (°C)	40	40	40	40	—	—
Maximum measured temperature T of part/at.....:		T (°C)					Allowed T (°C) T _{ma} =40°C
Test condition		Vertic al	Horiz on tal	Vertic al	Horiz on tal		--
Plug Holder body		58,0	59,6	51,3	51,5		105,0
Internal wires body		57,2	58,4	50,4	50,5		80,0
MOV1 body		73,6	76,3	60,8	60,8		85,0
C1 body		78,4	82,2	65,8	66,0		105,0
PCB body near BD1		78,7	83,1	64,8	65,4		130,0
T1 Top side coil		88,8	95,2	79,1	80,1		110,0
T1 core		84,1	90,2	75,3	76,4		110,0
T1 Bottom side coil		92,5	99,3	80,8	81,6		110,0
Output wire body		54,8	57,4	52,8	53,2		60,0
Inside of enclosure near T1		72,5	77,7	65,8	66,8		105,0
Surface of enclosure near T1		54,9	58,1	51,6	52,6		95,0
Supplementary information:							
For component with temperature marking, allowed T= Tmax + Tamb – Tma(Tma = 40 °C, Tamb= 40 °C) ;							
Temperature T of winding:	t ₁ (°C)	R ₁ (Ω)	t ₂ (°C)	R ₂ (Ω)	T (°C)	Allowed T _{max} (°C)	Insulation class
--	--	--	--	--	--	--	--
Supplementary information:							

4.5.5	TABLE: Ball pressure test of thermoplastic parts		P
	Allowed impression diameter (mm)	≤ 2 mm	—
Part		Test temperature (°C)	Impression diameter (mm)
Plug holder, 2.05 x 2piece Material used: 1) SABIC Type SE1X(GG)(f1)		125	1,83
Supplementary information:			

IEC 60950-1			
Clause	Requirement + Test	Result - Remark	Verdict

4.7	TABLE: Resistance to fire					P
Part	Manufacturer of material	Type of material	Thickness (mm)	Flammability class	Evidence	
--	--	--	--	--	--	
Supplementary information: Refer to appended table 1.5.1.						

5.1	TABLE: touch current measurement			P
Measured between:	Measured (mA)	Limit (mA)	Comments/conditions	
Plastic enclosure(foil)	0,032	0,25	--	
Output connector	0,032	0,25	--	
supplementary information:				
--				

5.2	TABLE: Electric strength tests, impulse tests and voltage surge tests			P
Test voltage applied between:	Voltage shape (AC, DC, impulse, surge)	Test voltage (V)	Breakdown Yes / No	
Funcional:				
--	--	--	--	
Basic				
--	--	--	--	
Reinforced:				
Unit: Primary / SELV	DC	4242	No	
Unit: Primary / Enclosure with foil	DC	4242	No	
Insulation tapes	DC	4242	No	
Supplementary information: All testing Including after Humidity required of clause 2.9, there are including unit, transformer and all material of transformer, see appended tables 1.5.1				

5.3	TABLE: Fault condition tests		P
	Ambient temperature (°C)	25 °C	—
	Power source for EUT: Manufacturer, model/type, output rating	--	—

IEC 60950-1						
Clause	Requirement + Test			Result - Remark		Verdict
Component No.	Fault	Supply voltage (V)	Test time	Fuse #	Fuse current (A)	Observation
BD1 (V- - V+)	s-c	240	1 s	RF3	10 Ω , 1W	RF3 opened, NT, NB, NC, Repeat 9 times result were same I/P: 0A
C2	s-c	240	1 s	RF3	10 Ω , 1W	RF3 opened, NT, NB, NC, Repeat 9 times result were same I/P: 0A
T1 (3-5)	s-c	240	30 min	RF3	10 Ω , 1W	Unit shutdown, NT, NB, NC, IP(US1) I/P: 0,005A
T1 (6-7)	Overload	240	30 min	RF3	10 Ω , 1W	Unit shutdown, NT, NB, NC, IP(US1) I/P: 0,005A
T1 (7) after D53	Overload	240	2h 51 min	RF3	10 Ω , 1W	CT at 0.1A (Output load:1A, total 1.1A), increased to 0.2A, Unit shutdown, NT, NC, NB, IP(US1), T1 coil=85°C, Ambient air=26°C I/P: 0,05 A
+5V - RTN	s-c	240	30 min	RF3	10 Ω , 1W	Unit shutdown, NT, NB, NC, IP(US1) I/P: 0,003A
+5V output	Overload	240	2h 51 min	RF3	10 Ω , 1W	CT at 1,1A, increased to 1,2 A, Unit shutdown, NT, NC, NB, IP(US1), T1 coil=78°C, Ambient air=24,9°C I/P: 0,049 A
used 32A current protect						
BD1 (V- - V+)	s-c	240	1 s	RF3	10 Ω , 1W	RF3 opened, NT, NB, NC, Repeat 9 times result were same I/P: 0A

IEC 60950-1						
Clause	Requirement + Test				Result - Remark	Verdict
C2	s-c	240	1 s	RF3	10 Ω , 1W	RF3 opened, NT, NB, NC, Repeat 9 times result were same I/P: 0A
<p>Supplementary information:</p> <p>1) s-c: short circuit, o-c: open circuit, o-l: overload.</p> <p>2) YC: Cheesecloth charred or flamed</p> <p>NT: Tissue paper remained intact</p> <p>RF: Repeat all fuse result were the same.</p> <p>YT: Tissue paper charred or flamed</p> <p>IP: Internal protection operated (list component)</p> <p>I/P: Input current</p> <p>RF: Repeat all fuse result were same</p> <p>IP: Internal protection operated (list component)</p>						

IEC 60950-1			
Clause	Requirement + Test	Result - Remark	Verdict

C.2		TABLE: transformers						P
Loc.	Tested insulation	Working voltage peak / V (2.10.2)	Working voltage rms / V (2.10.2)	Required electric strength (5.2)	Required clearance / mm (2.10.3)	Required creepage distance / mm (2.10.4)	Required distance thr. insul. (2.10.5)	
T1	Reinforced: Primary to secondary	472	250	3000 Va.c.	4,2	5,0	0,4	
T1	Reinforced: Secondary winding to core	472	250	3000 Va.c.	4,2	5,0	0,4	
Loc.	Tested insulation			Test voltage/ V	Measured clearance / mm	Measured creepage dist./ mm	Measured distance thr. insul. / mm; number of layers	
T1	Reinforced: Primary to secondary			3000 Va.c.	6,3	6,3	TIW	
T1	Reinforced: Secondary winding to core			3000 Va.c.	7,6	7,6	TIW	
supplementary information:								
All testing Including after Humidity required of clause 2.9, there are including unit, transformer and all material of transformer, see appended tables 1.5.1								

IEC 60950-1			
Clause	Requirement + Test	Result - Remark	Verdict

C.2	TABLE: transformers		P
-----	---------------------	--	---

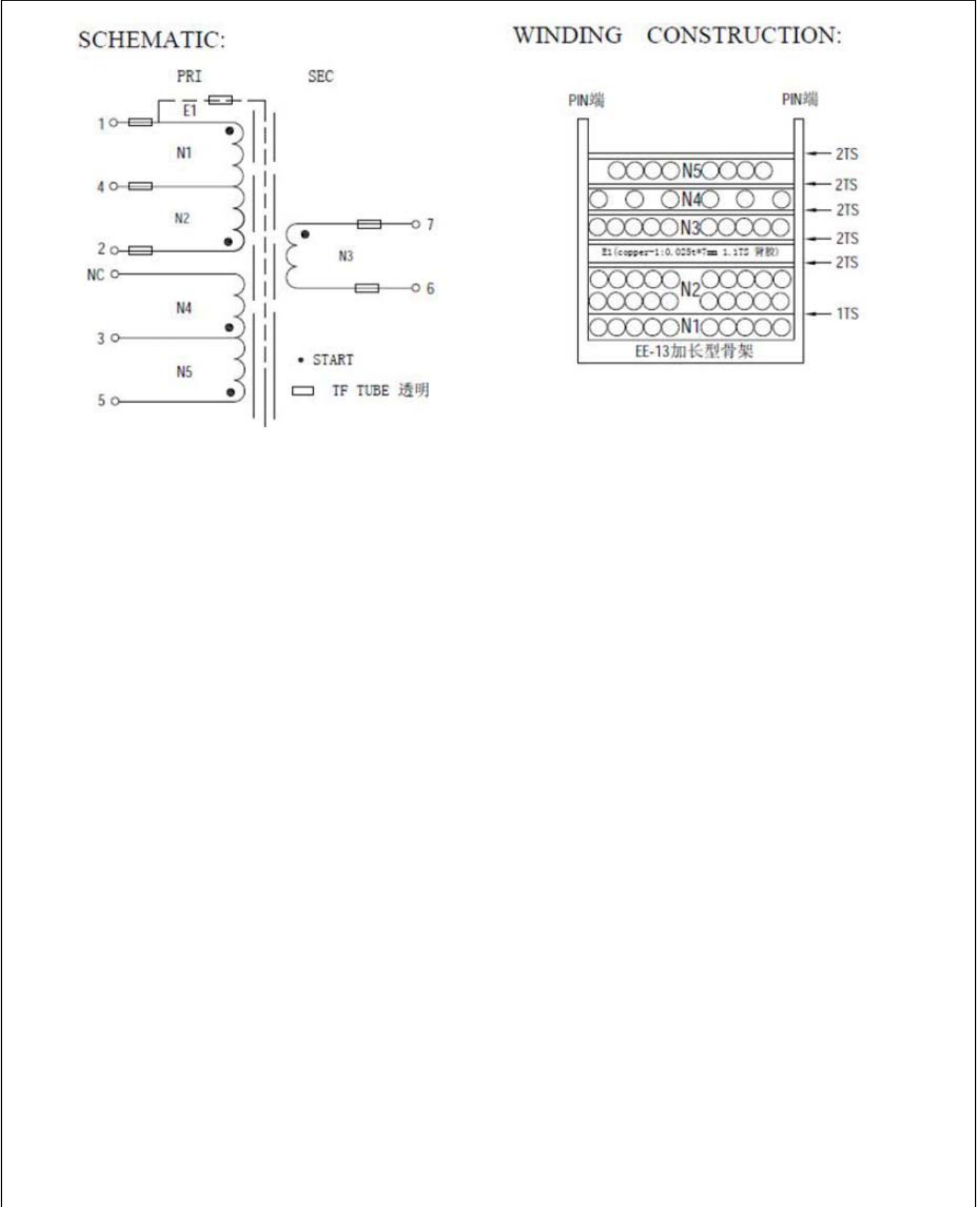

IEC 60950-1			
Clause	Requirement + Test	Result - Remark	Verdict

1. OUTLINE DIMENSION: (UNIT: mm)

The technical drawings show the following dimensions and features:

- ELEVATION VIEW:** Overall width is 15.0 MAX. The main body height is 14.5 MAX. The bottom section height is 3.3 ± 0.3. The component is labeled with 'XF00865 E308897' and 'ENG 130-1 YYWV ENSEC'. Terminals 1 and 5 are shown.
- SIDE VIEW:** Overall width is 21.0 MAX. The bottom section height is 0.6 ± 0.1. Terminals 5 and 6 are shown.
- BOTTOM VIEW:** The distance between terminals 1 and 5 is 2.75 ± 0.5. The overall width is 9.0 ± 0.5. The height of the main body is 16.0 ± 0.5. Terminals 7 and 6 are also shown.
- TOP VIEW:** Shows the layout of terminals 5, 1, 6, and 7.

4. WINDING TABLE

WINDING	MARGIN TAP PAN/TOP	START	FINISH	WIRE SIZE	TURNS	TAPE	NOTES
N1		1	4	Φ0.15*1P	42Ts	1Ts	密繞
N2		2	4	Φ0.15*1P	84Ts	2Ts	密繞
E1		1		0.025*7T	1.1Ts	2Ts	背膠
N3		7	6	Φ0.5*1P (三層絕緣線)	9Ts	2Ts	密繞
N4		3		Φ0.15*1P	3Ts	2Ts	均繞
N5		5	3	Φ0.15*1P	25Ts	2Ts	居中密繞

****End of Test report****

Attachment 1 Photo documentation

Whole unit



Side view



Attachment 1 Photo documentation

PCB

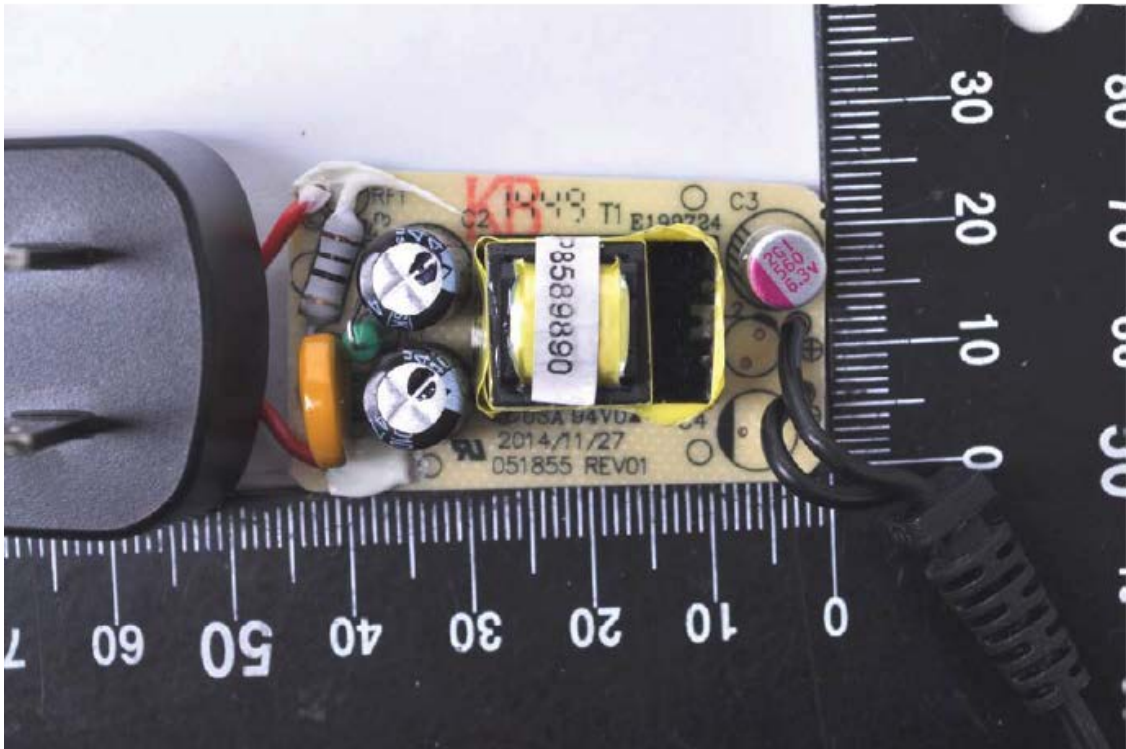

PCB

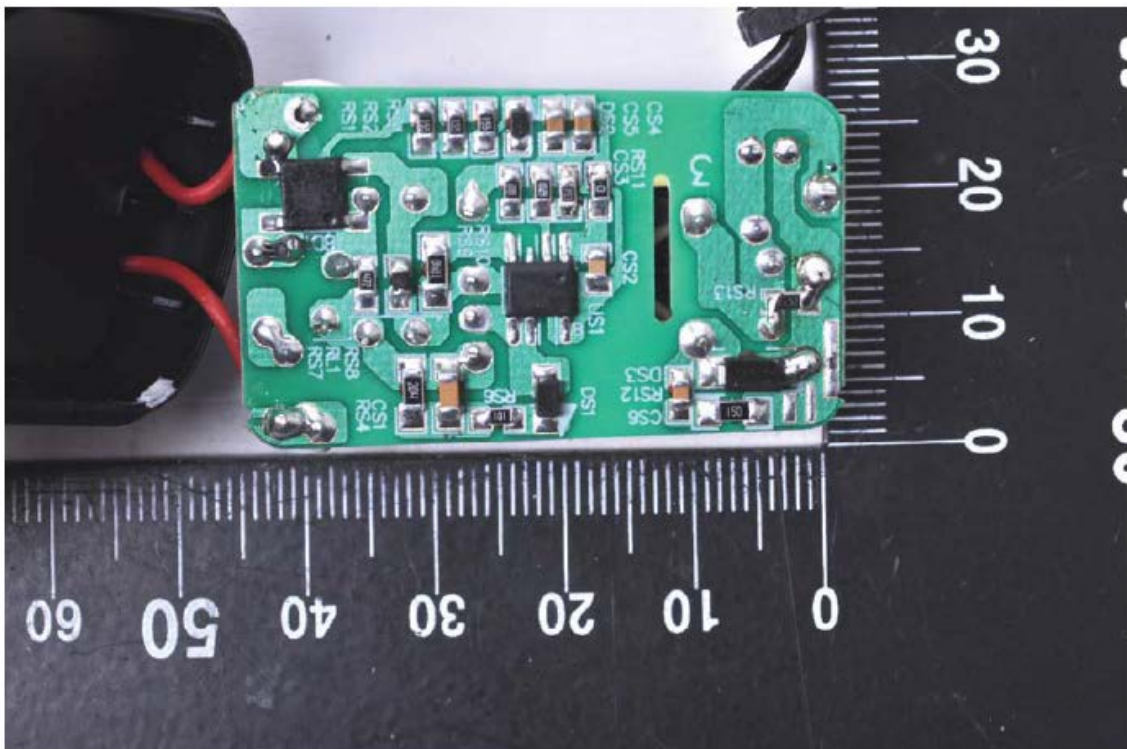

Attachment 1 Photo documentation

Internal view



Internal view



Circuit diagram

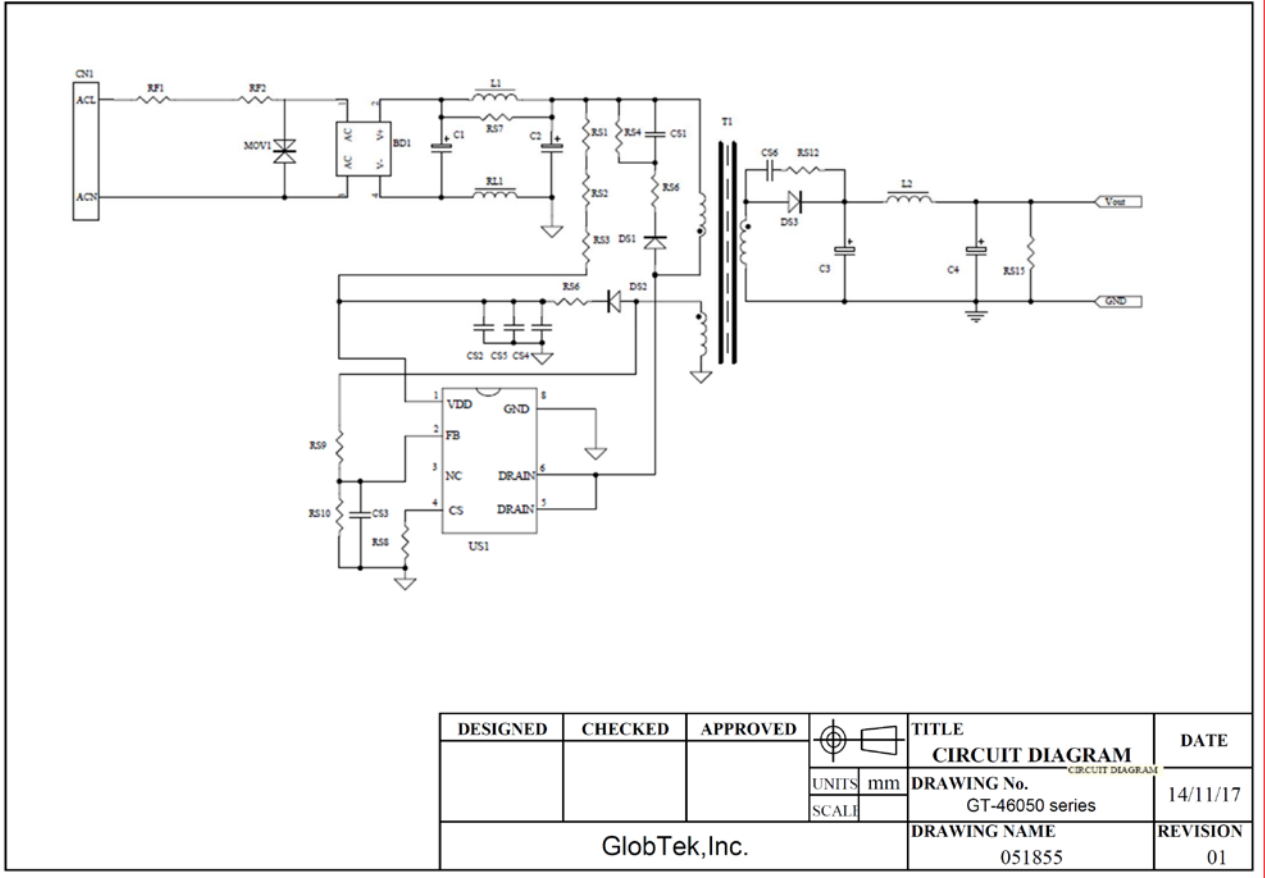

PCB Layout

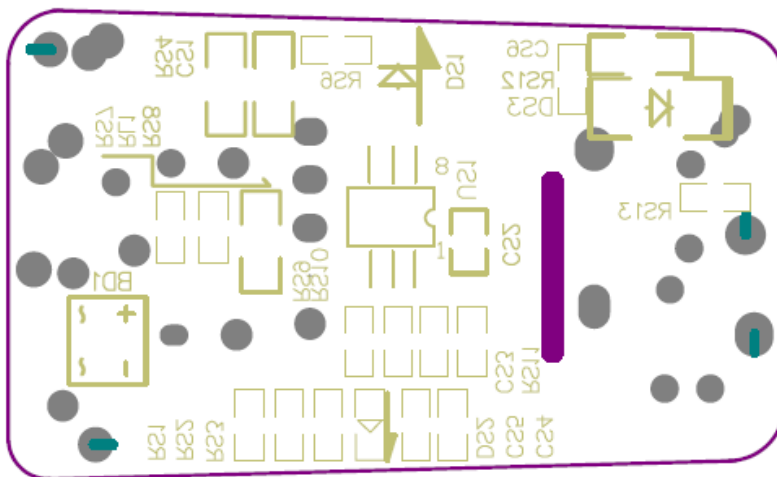
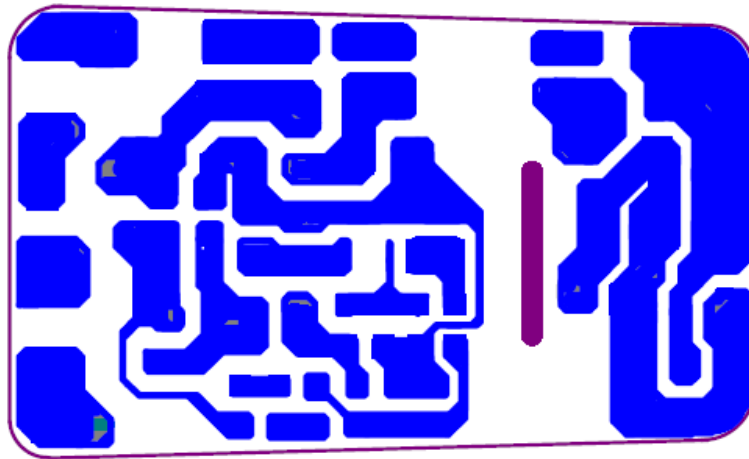
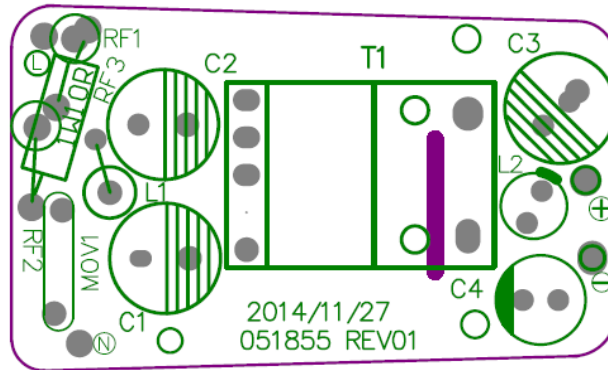

*****End of attachment 2*****

Attachment 3 Safety Information in User Manual

Allgemeines (General)

To comply with the published safety standards, the following must be considered when using this switching power supply.

Um den zur Zeit gültigen Sicherheitsbestimmungen zu genügen, müssen die folgenden Hinweise beim Einsatz dieses Schaltnetzteils berücksichtigt werden:

1. The appliance is used for IT and similar electronic apparatus. It is certified according to the relevant safety standards IEC60950 and EN60950.

Dieses Netzgerät ist ein Tischgerät IT und Datenverarbeitungseräten. Es ist geprüft nach den einschlägigen Bestimmungen IEC60950, und EN60950.

2. The output power taken from the supply must not exceed the rating given on the switching power supply. Die Ausgangsleistung darf die auf dem Netzgerät angegebenen Werte nicht übersteigen.

3. The appliance is not intended to be repaired by service personnel in case of failure or component defect (unit can be thrown away)

In einem Fehlerfall werden Teile des Gerätes, bzw. das Gerät selbst nicht durch den Kundendienst repariert. Das Gerät muss entsorgt werden.

4. The mains plug is used as the disconnect device, the disconnect device shall remain readily operable.

Die Steckdose muß in der Nähe der Einrichtung angebracht und leicht zugänglich sein.

5. The appliance shall not be exposed to dripping or splashing and that no objects filled with liquids, such as vases, shall be placed on the appliance.

Das Gerät darf nicht Spritzwasser oder tropfenden Flüssigkeiten ausgesetzt werden. Kein mit Wasser gefüllten Gefäße auf dem Gerät abstellen.

6. The switching power supply should be used in ventilated condition, should not cover the power supply with other things.

Das Batterieladegerät sollte unter belüfteter Bedingung benutzt werden. Der Netzanschluss darf nicht mit anderen Dingen bedecken werden.

*****End of Attachment 3*****

IEC60950_1E - ATTACHMENT			
Clause	Requirement + Test	Result - Remark	Verdict

Attachment 4 Deviation of EUROPEAN GROUP DIFFERENCES AND NATIONAL DIFFERENCES

<p>ATTACHMENT TO TEST REPORT IEC 60950-1 EUROPEAN GROUP DIFFERENCES AND NATIONAL DIFFERENCES Information technology equipment – Safety – Part 1: General requirements</p>	
Differences according to.....:	EN 60950-1:2006/A11:2009/A1:2010/A12:2011/A2:2013
Attachment Form No.....:	EU_GD_IEC60950_1E
Attachment Originator	SGS Fimko Ltd
Master Attachment.....:	Date 2013-09
<p>Copyright © 2013 IEC System for Conformity Testing and Certification of Electrical Equipment (IECEE), Geneva, Switzerland. All rights reserved.</p>	

EN 60950-1:2006/A11:2009/A1:2010/A12:2011/A2:2013 – CENELEC COMMON MODIFICATIONS

IEC 60950-1, GROUP DIFFERENCES (CENELEC common modifications EN)			
Clause	Requirement + Test	Result - Remark	Verdict
	Clauses, subclauses, notes, tables and figures which are additional to those in IEC60950-1 and it's amendmets are prefixed "Z"		P
Contents (A2:2013)	Add the following annexes: Annex ZA (normative) Normative references to international publications with their corresponding European publications Annex ZB (normative) Special national conditions Annex ZD (informative) IEC and CENELEC code designations for flexible cords		P
General	Delete all the "country" notes in the reference document (IEC 60950-1:2005) according to the following list: 1.4.8 Note 2 1.5.1 Note 2 & 3 1.5.7.1 Note 1.5.8 Note 2 1.5.9.4 Note 1.7.2.1 Note 4, 5 & 6 2.2.3 Note 2.2.4 Note 2.3.2 Note 2.3.2.1 Note 2 2.3.4 Note 2 2.6.3.3 Note 2 & 3 2.7.1 Note 2.10.3.2 Note 2 2.10.5.13 Note 3 3.2.1.1 Note 3.2.4 Note 3. 2.5.1 Note 2 4.3.6 Note 1 & 2 4.7 Note 4 4.7.2.2 Note 4.7.3.1Note 2 5.1.7.1 Note 3 & 4 5.3.7 Note 1 6 Note 2 & 5 6.1.2.1 Note 2 6.1.2.2 Note 6.2.2 Note 6.2.2.1 Note 2 6.2.2.2 Note 7.1 Note 3 7.2 Note 7.3 Note 1 & 2 G.2.1 Note 2 Annex H Note 2		P
General (A1:2010)	Delete all the "country" notes in the reference document (IEC 60950-1:2005/A1:2010) according to the following list: 1.5.7.1 Note 6.1.2.1 Note 2 6.2.2.1 Note 2 EE.3 Note		P

IEC60950_1E - ATTACHMENT			
Clause	Requirement + Test	Result - Remark	Verdict

Attachment 4 Deviation of EUROPEAN GROUP DIFFERENCES AND NATIONAL DIFFERENCES

IEC 60950-1, GROUP DIFFERENCES (CENELEC common modifications EN)			
Clause	Requirement + Test	Result - Remark	Verdict
General (A2:2013)	Delete all the "country" notes in the reference document (IEC 60950-1:2005/A2:2013) according to the following list: 2.7.1 Note * 2.10.3.1 Note 2 6.2.2. Note * Note of secretary: Text of Common Modification remains unchanged.		P
1.1.1 (A1:2010)	Replace the text of NOTE 3 by the following. NOTE 3 The requirements of EN 60065 may also be used to meet safety requirements for multimedia equipment. See IEC Guide 112, Guide on the safety of multimedia equipment. For television sets EN 60065 applies.		P
1.3.Z1	Add the following subclause: 1.3.Z1 Exposure to excessive sound pressure The apparatus shall be so designed and constructed as to present no danger when used for its intended purpose, either in normal operating conditions or under fault conditions, particularly providing protection against exposure to excessive sound pressures from headphones or earphones. NOTE Z1 A new method of measurement is described in EN 50332-1, Sound system equipment: Headphones and earphones associated with portable audio equipment - Maximum sound pressure level measurement methodology and limit considerations - Part 1: General method for "one package equipment", and in EN 50332-2, Sound system equipment: Headphones and earphones associated with portable audio equipment - Maximum sound pressure level measurement methodology and limit considerations - Part 2: Guidelines to associate sets with headphones coming from different manufacturers.	No headphone and earphone.	N/A
(A12:2011)	In EN 60950-1:2006/A12:2011 Delete the addition of 1.3.Z1 / EN 60950-1:2006 Delete the definition 1.2.3.Z1 / EN 60950-1:2006 /A1:2010		N/A
1.5.1 (Added info*)	Add the following NOTE: NOTE Z1 The use of certain substances in electrical and electronic equipment is restricted within the EU: see Directive 2002/95/EC. New Directive 2011/65/11 *		P
1.7.2.1 (A1:2010)	In addition, for a PORTABLE SOUND SYSTEM, the instructions shall include a warning that excessive sound pressure from earphones and headphones can cause hearing loss.	No headphone and earphone.	N/A
1.7.2.1 (A12:2011)	In EN 60950-1:2006/A12:2011 Delete NOTE Z1 and the addition for Portable Sound System. Add the following clause and annex to the existing standard and amendments.		N/A

IEC60950_1E - ATTACHMENT			
Clause	Requirement + Test	Result - Remark	Verdict

Attachment 4 Deviation of EUROPEAN GROUP DIFFERENCES AND NATIONAL DIFFERENCES

IEC 60950-1, GROUP DIFFERENCES (CENELEC common modifications EN)			
Clause	Requirement + Test	Result - Remark	Verdict
	<p>Zx Protection against excessive sound pressure from personal music players</p>		N/A
	<p>Zx.1 General</p> <p>This sub-clause specifies requirements for protection against excessive sound pressure from personal music players that are closely coupled to the ear. It also specifies requirements for earphones and headphones intended for use with personal music players.</p> <p>A personal music player is a portable equipment for personal use, that:</p> <ul style="list-style-type: none"> – is designed to allow the user to listen to recorded or broadcast sound or video; and – primarily uses headphones or earphones that can be worn in or on or around the ears; and – allows the user to walk around while in use. <p>NOTE 1 Examples are hand-held or body-worn portable CD players, MP3 audio players, mobile phones with MP3 type features, PDA's or similar equipment.</p> <p>A personal music player and earphones or headphones intended to be used with personal music players shall comply with the requirements of this sub-clause.</p> <p>The requirements in this sub-clause are valid for music or video mode only.</p> <p>The requirements do not apply:</p> <ul style="list-style-type: none"> – while the personal music player is connected to an external amplifier; or – while the headphones or earphones are not used. <p>NOTE 2 An external amplifier is an amplifier which is not part of the personal music player or the listening device, but which is intended to play the music as a standalone music player.</p> <p>The requirements do not apply to:</p> <ul style="list-style-type: none"> – hearing aid equipment and professional equipment; <p>NOTE 3 Professional equipment is equipment sold through special sales channels. All products sold through normal electronics stores are considered not to be professional equipment.</p>		N/A

IEC60950_1E - ATTACHMENT			
Clause	Requirement + Test	Result - Remark	Verdict

Attachment 4 Deviation of EUROPEAN GROUP DIFFERENCES AND NATIONAL DIFFERENCES

IEC 60950-1, GROUP DIFFERENCES (CENELEC common modifications EN)			
Clause	Requirement + Test	Result - Remark	Verdict
	<p>– analogue personal music players (personal music players without any kind of digital processing of the sound signal) that are brought to the market before the end of 2015.</p> <p>NOTE 4 This exemption has been allowed because this technology is falling out of use and it is expected that within a few years it will no longer exist. This exemption will not be extended to other technologies.</p> <p>For equipment which is clearly designed or intended for use by young children, the limits of EN 71-1 apply.</p>		N/A
	<p>Zx.2 Equipment requirements</p> <p>No safety provision is required for equipment that complies with the following:</p> <ul style="list-style-type: none"> – equipment provided as a package (personal music player with its listening device), where the acoustic output $L_{Aeq,T}$ is ≤ 85 dBA measured while playing the fixed “programme simulation noise” as described in EN 50332-1; and – a personal music player provided with an analogue electrical output socket for a listening device, where the electrical output is ≤ 27 mV measured as described in EN 50332-2, while playing the fixed “programme simulation noise” as described in EN 50332-1. <p>NOTE 1 Wherever the term acoustic output is used in this clause, the 30 s A-weighted equivalent sound pressure level $L_{Aeq,T}$ is meant. See also Zx.5 and Annex Zx.</p> <p>All other equipment shall:</p> <ol style="list-style-type: none"> a) protect the user from unintentional acoustic outputs exceeding those mentioned above; and b) have a standard acoustic output level not exceeding those mentioned above, and automatically return to an output level not exceeding those mentioned above when the power is switched off; and 		N/A

IEC60950_1E - ATTACHMENT			
Clause	Requirement + Test	Result - Remark	Verdict

Attachment 4 Deviation of EUROPEAN GROUP DIFFERENCES AND NATIONAL DIFFERENCES

IEC 60950-1, GROUP DIFFERENCES (CENELEC common modifications EN)			
Clause	Requirement + Test	Result - Remark	Verdict
	<p>c) provide a means to actively inform the user of the increased sound pressure when the equipment is operated with an acoustic output exceeding those mentioned above. Any means used shall be acknowledged by the user before activating a mode of operation which allows for an acoustic output exceeding those mentioned above. The acknowledgement does not need to be repeated more than once every 20 h of cumulative listening time; and</p> <p>NOTE 2 Examples of means include visual or audible signals. Action from the user is always required.</p> <p>NOTE 3 The 20 h listening time is the accumulative listening time, independent how often and how long the personal music player has been switched off.</p> <p>d) have a warning as specified in Zx.3; and</p> <p>e) not exceed the following:</p> <ol style="list-style-type: none"> 1) equipment provided as a package (player with its listening device), the acoustic output shall be ≤ 100 dBA measured while playing the fixed "programme simulation noise" described in EN 50332-1; and 2) a personal music player provided with an analogue electrical output socket for a listening device, the electrical output shall be ≤ 150 mV measured as described in EN 50332-2, while playing the fixed "programme simulation noise" described in EN 50332-1. <p>For music where the average sound pressure (long term $L_{Aeq,T}$) measured over the duration of the song is lower than the average produced by the programme simulation noise, the warning does not need to be given as long as the average sound pressure of the song is below the basic limit of 85 dBA. In this case T becomes the duration of the song.</p> <p>NOTE 4 Classical music typically has an average sound pressure (long term $L_{Aeq,T}$) which is much lower than the average programme simulation noise. Therefore, if the player is capable to analyse the song and compare it with the programme simulation noise, the warning does not need to be given as long as the average sound pressure of the song is below the basic limit of 85 dBA.</p> <p>For example, if the player is set with the programme simulation noise to 85 dBA, but the average music level of the song is only 65 dBA, there is no need to give a warning or ask an acknowledgement as long as the average sound level of the song is not above the basic limit of 85 dBA.</p>		N/A

IEC60950_1E - ATTACHMENT			
Clause	Requirement + Test	Result - Remark	Verdict

Attachment 4 Deviation of EUROPEAN GROUP DIFFERENCES AND NATIONAL DIFFERENCES

IEC 60950-1, GROUP DIFFERENCES (CENELEC common modifications EN)			
Clause	Requirement + Test	Result - Remark	Verdict
	<p>Zx.3 Warning</p> <p>The warning shall be placed on the equipment, or on the packaging, or in the instruction manual and shall consist of the following:</p> <ul style="list-style-type: none"> – the symbol of Figure 1 with a minimum height of 5 mm; and – the following wording, or similar: <p>“To prevent possible hearing damage, do not listen at high volume levels for long periods.”</p>  <p>Figure 1 – Warning label (IEC 60417-6044)</p> <p>Alternatively, the entire warning may be given through the equipment display during use, when the user is asked to acknowledge activation of the higher level.</p>		N/A
	<p>Zx.4 Requirements for listening devices (headphones and earphones)</p>		N/A
	<p>Zx.4.1 Wired listening devices with analogue input</p> <p>With 94 dBA sound pressure output $L_{Aeq,T}$, the input voltage of the fixed “programme simulation noise” described in EN 50332-2 shall be ≥ 75 mV.</p> <p>This requirement is applicable in any mode where the headphones can operate (active or passive), including any available setting (for example built-in volume level control).</p> <p>NOTE The values of 94 dBA – 75 mV correspond with 85dBA – 27 mV and 100 dBA – 150 mV.</p>		N/A

IEC60950_1E - ATTACHMENT			
Clause	Requirement + Test	Result - Remark	Verdict

Attachment 4 Deviation of EUROPEAN GROUP DIFFERENCES AND NATIONAL DIFFERENCES

IEC 60950-1, GROUP DIFFERENCES (CENELEC common modifications EN)			
Clause	Requirement + Test	Result - Remark	Verdict
	<p>Zx.4.2 Wired listening devices with digital input</p> <p>With any playing device playing the fixed “programme simulation noise” described in EN 50332-1 (and respecting the digital interface standards, where a digital interface standard exists that specifies the equivalent acoustic level), the acoustic output $L_{Aeq,T}$ of the listening device shall be ≤ 100 dBA.</p> <p>This requirement is applicable in any mode where the headphones can operate, including any available setting (for example built-in volume level control, additional sound feature like equalization, etc.).</p> <p>NOTE An example of a wired listening device with digital input is a USB headphone.</p>		N/A
	<p>Zx.4.3 Wireless listening devices</p> <p>In wireless mode:</p> <ul style="list-style-type: none"> – with any playing and transmitting device playing the fixed programme simulation noise described in EN 50332-1; and – respecting the wireless transmission standards, where an air interface standard exists that specifies the equivalent acoustic level; and – with volume and sound settings in the listening device (for example built-in volume level control, additional sound feature like equalization, etc.) set to the combination of positions that maximize the measured acoustic output for the abovementioned programme simulation noise, the acoustic output $L_{Aeq,T}$ of the listening device shall be ≤ 100 dBA. <p>NOTE An example of a wireless listening device is a Bluetooth headphone.</p>		N/A
	<p>Zx.5 Measurement methods</p> <p>Measurements shall be made in accordance with EN 50332-1 or EN 50332-2 as applicable. Unless stated otherwise, the time interval T shall be 30 s.</p> <p>NOTE Test method for wireless equipment provided without listening device should be defined.</p>		N/A

IEC60950_1E - ATTACHMENT			
Clause	Requirement + Test	Result - Remark	Verdict

Attachment 4 Deviation of EUROPEAN GROUP DIFFERENCES AND NATIONAL DIFFERENCES

IEC 60950-1, GROUP DIFFERENCES (CENELEC common modifications EN)									
Clause	Requirement + Test	Result - Remark	Verdict						
2.7.1	<p>Replace the subclause as follows:</p> <p>Basic requirements</p> <p>To protect against excessive current, short-circuits and earth faults in PRIMARY CIRCUITS, protective devices shall be included either as integral parts of the equipment or as parts of the building installation, subject to the following, a), b) and c):</p> <p>a) except as detailed in b) and c), protective devices necessary to comply with the requirements of 5.3 shall be included as parts of the equipment;</p> <p>b) for components in series with the mains input to the equipment such as the supply cord, appliance coupler, r.f.i. filter and switch, short-circuit and earth fault protection may be provided by protective devices in the building installation;</p>	The equipment is provided with a fuse and complies with a).	P						
	<p>c) it is permitted for PLUGGABLE EQUIPMENT TYPE B or PERMANENTLY CONNECTED EQUIPMENT, to rely on dedicated overcurrent and short-circuit protection in the building installation, provided that the means of protection, e.g. fuses or circuit breakers, is fully specified in the installation instructions.</p> <p>If reliance is placed on protection in the building installation, the installation instructions shall so state, except that for PLUGGABLE EQUIPMENT TYPE A the building installation shall be regarded as providing protection in accordance with the rating of the wall socket outlet.</p>		N/A						
2.7.2	This subclause has been declared 'void'.		—						
3.2.3	Delete the NOTE in Table 3A, and delete also in this table the conduit sizes in parentheses.	Not permanently connected equipment.	N/A						
3.2.5.1	<p>Replace "60245 IEC 53" by "H05 RR-F";</p> <p>"60227 IEC 52" by "H03 VV-F or H03 VVH2-F";</p> <p>"60227 IEC 53" by "H05 VV-F or H05 VVH2-F2".</p> <p>In Table 3B, replace the first four lines by the following:</p> <table border="0"> <tr> <td>Up to and including 6 </td> <td>0,75^{a)} </td> </tr> <tr> <td>Over 6 up to and including 10 </td> <td>(0,75)^{b)} 1,0 </td> </tr> <tr> <td>Over 10 up to and including 16 </td> <td>(1,0)^{c)} 1,5 </td> </tr> </table> <p>In the conditions applicable to Table 3B delete the words "in some countries" in condition^{a)}.</p> <p>In NOTE 1, applicable to Table 3B, delete the second sentence.</p>	Up to and including 6	0,75 ^{a)}	Over 6 up to and including 10	(0,75) ^{b)} 1,0	Over 10 up to and including 16	(1,0) ^{c)} 1,5	No power supply cord provided.	N/A
Up to and including 6	0,75 ^{a)}								
Over 6 up to and including 10	(0,75) ^{b)} 1,0								
Over 10 up to and including 16	(1,0) ^{c)} 1,5								

IEC60950_1E - ATTACHMENT			
Clause	Requirement + Test	Result - Remark	Verdict

Attachment 4 Deviation of EUROPEAN GROUP DIFFERENCES AND NATIONAL DIFFERENCES

IEC 60950-1, GROUP DIFFERENCES (CENELEC common modifications EN)			
Clause	Requirement + Test	Result - Remark	Verdict
3.2.5.1 (A2:2013)	NOTE Z1 The harmonised code designations corresponding to the IEC cord types are given in Annex ZD		N/A
3.3.4	In Table 3D, delete the fourth line: conductor sizes for 10 to 13 A, and replace with the following: Over 10 up to and including 16 1,5 to 2,5 1,5 to 4 Delete the fifth line: conductor sizes for 13 to 16 A		N/A
4.3.13.6 (A1:2010)	Replace the existing NOTE by the following: NOTE Z1 Attention is drawn to: 1999/519/EC: Council Recommendation on the limitation of exposure of the general public to electromagnetic fields 0 Hz to 300 GHz, and 2006/25/EC: Directive on the minimum health and safety requirements regarding the exposure of workers to risks arising from physical agents (artificial optical radiation).		N/A
	Standards taking into account mentioned Recommendation and Directive which demonstrate compliance with the applicable EU Directive are indicated in the OJEC.		N/A
Annex H	Replace the last paragraph of this annex by: At any point 10 cm from the surface of the OPERATOR ACCESS AREA, the dose rate shall not exceed 1 µSv/h (0,1 mR/h) (see NOTE). Account is taken of the background level. Replace the notes as follows: NOTE These values appear in Directive 96/29/Euratom. Delete NOTE 2.	No ionizing radiation.	N/A
Bibliography	Additional EN standards.		—

ZA	NORMATIVE REFERENCES TO INTERNATIONAL PUBLICATIONS WITH THEIR CORRESPONDING EUROPEAN PUBLICATIONS	—
-----------	--	---

ZB ANNEX (normative) SPECIAL NATIONAL CONDITIONS (EN)			
Clause	Requirement + Test	Result - Remark	Verdict
1.2.4.1	In Denmark , certain types of Class I appliances (see 3.2.1.1) may be provided with a plug not establishing earthing conditions when inserted into Danish socket-outlets.	Shall be evaluated when marketed in Denmark.	N/A
1.2.13.14 (A11:2009)	In Norway and Sweden , for requirements see 1.7.2.1 and 7.3 of this annex.	Not intended to be connected to cable distribution system.	N/A

IEC60950_1E - ATTACHMENT

Clause	Requirement + Test	Result - Remark	Verdict
--------	--------------------	-----------------	---------

Attachment 4 Deviation of EUROPEAN GROUP DIFFERENCES AND NATIONAL DIFFERENCES

ZB ANNEX (normative) SPECIAL NATIONAL CONDITIONS (EN)			
Clause	Requirement + Test	Result - Remark	Verdict
1.5.7.1 (A11:2009)	In Finland, Norway and Sweden , resistors bridging BASIC INSULATION in CLASS I PLUGGABLE EQUIPMENT TYPE A must comply with the requirements in 1.5.7.1. In addition when a single resistor is used, the resistor must withstand the resistor test in 1.5.7.2.	Shall be evaluated when marketed in Finland, Norway and Sweden.	N/A
1.5.8	In Norway , due to the IT power system used (see annex V, Figure V.7), capacitors are required to be rated for the applicable line-to-line voltage (230 V).		N/A
1.5.9.4	In Finland, Norway and Sweden , the third dashed sentence is applicable only to equipment as defined in 6.1.2.2 of this annex.	No TNV circuit.	N/A

IEC60950_1E - ATTACHMENT

Clause	Requirement + Test	Result - Remark	Verdict
--------	--------------------	-----------------	---------

Attachment 4 Deviation of EUROPEAN GROUP DIFFERENCES AND NATIONAL DIFFERENCES

<p align="center">ZB ANNEX (normative) SPECIAL NATIONAL CONDITIONS (EN)</p>			
Clause	Requirement + Test	Result - Remark	Verdict
1.7.2.1	<p>In Finland, Norway and Sweden, CLASS I PLUGGABLE EQUIPMENT TYPE A intended for connection to other equipment or a network shall, if safety relies on connection to protective earth or if surge suppressors are connected between the network terminals and accessible parts, have a marking stating that the equipment must be connected to an earthed mains socket-outlet.</p> <p>The marking text in the applicable countries shall be as follows:</p> <p>In Finland: "Laite on liitettävä suojakoskettimilla varustettuun pistorasiaan"</p> <p>In Norway: "Apparatet må tilkoples jordet stikkontakt"</p> <p>In Sweden: "Apparaten skall anslutas till jordat uttag"</p>	<p>Shall be evaluated when marketed in Finland, Norway and Sweden.</p>	N/A
1.7.2.1 (A11:2009)	<p>In Norway and Sweden, the screen of the cable distribution system is normally not earthed at the entrance of the building and there is normally no equipotential bonding system within the building. Therefore the protective earthing of the building installation need to be isolated from the screen of a cable distribution system.</p> <p>It is however accepted to provide the insulation external to the equipment by an adapter or an interconnection cable with galvanic isolator, which may be provided by e.g. a retailer.</p> <p>The user manual shall then have the following or similar information in Norwegian and Swedish language respectively, depending on in what country the equipment is intended to be used in:</p> <p>"Equipment connected to the protective earthing of the building installation through the mains connection or through other equipment with a connection to protective earthing – and to a cable distribution system using coaxial cable, may in some circumstances create a fire hazard. Connection to a cable distribution system has therefore to be provided through a device providing electrical isolation below a certain frequency range (galvanic isolator, see EN 60728-11)."</p>		

IEC60950_1E - ATTACHMENT			
Clause	Requirement + Test	Result - Remark	Verdict

Attachment 4 Deviation of EUROPEAN GROUP DIFFERENCES AND NATIONAL DIFFERENCES

ZB ANNEX (normative) SPECIAL NATIONAL CONDITIONS (EN)			
Clause	Requirement + Test	Result - Remark	Verdict
	<p>NOTE In Norway, due to regulation for installations of cable distribution systems, and in Sweden, a galvanic isolator shall provide electrical insulation below 5 MHz. The insulation shall withstand a dielectric strength of 1,5 kV r.m.s., 50 Hz or 60 Hz, for 1 min.</p> <p>Translation to Norwegian (the Swedish text will also be accepted in Norway): "Utstyr som er koplet til beskyttelsesjord via nettplugg og/eller via annet jordtilkoplet utstyr – og er tilkoplet et kabel-TV nett, kan forårsake brannfare. For å unngå dette skal det ved tilkopling av utstyret til kabel-TV nettet installeres en galvanisk isolator mellom utstyret og kabel- TV nettet."</p> <p>Translation to Swedish: "Utrustning som är kopplad till skyddsjord via jordat vägguttag och/eller via annan utrustning och samtidigt är kopplad till kabel-TV nät kan i vissa fall medföra risk för brand. För att undvika detta skall vid anslutning av utrustningen till kabel-TV nät galvanisk isolator finnas mellan utrustningen och kabel-TV nätet."</p>		N/A
1.7.2.1 (A2:2013)	<p>In Denmark, CLASS I PLUGGABLE EQUIPMENT TYPE A intended for connection to other equipment or a network shall, if safety relies on connection to protective earth or if surge suppressors are connected between the network terminals and accessible parts, have a marking stating that the equipment must be connected to an earthed mains socket-outlet.</p> <p>The marking text in Denmark shall be as follows: In Denmark: "Apparatets stikprop skal tilsluttes en stikkontakt med jord, som giver forbindelse til stikproppens jord."</p>	Shall be evaluated when marketed in Denmark.	N/A
1.7.5 1.7.5 (A11:2009)	<p>In Denmark, socket-outlets for providing power to other equipment shall be in accordance with the Heavy Current Regulations, Section 107-2-D1, Standard Sheet DK 1-3a, DK 1-5a or DK 1-7a, when used on Class I equipment. For STATIONARY EQUIPMENT the socket-outlet shall be in accordance with Standard Sheet DK 1-1b or DK 1-5a.</p> <p>For CLASS II EQUIPMENT the socket outlet shall be in accordance with Standard Sheet DKA 1-4a.</p>		N/A

IEC60950_1E - ATTACHMENT			
Clause	Requirement + Test	Result - Remark	Verdict

Attachment 4 Deviation of EUROPEAN GROUP DIFFERENCES AND NATIONAL DIFFERENCES

ZB ANNEX (normative) SPECIAL NATIONAL CONDITIONS (EN)			
Clause	Requirement + Test	Result - Remark	Verdict
1.7.5 (A2:2013)	<p>In Denmark, socket-outlets for providing power to other equipment shall be in accordance with the DS 60884-2-D1:2011.</p> <p>For class I equipment the following Standard Sheets are applicable: DK 1-3a, DK 1-1c, DK 1-1d, DK 1-5a or DK 1-7a, with the exception for STATIONARY EQUIPMENT where the socket-outlets shall be in accordance with Standard Sheet DK 1-1b, DK 1-1c, DK 1-1d or DK 1-5a.</p> <p>Socket outlets intended for providing power to Class II apparatus with a rated current of 2,5 A shall be in accordance with DS 60884-2-D1 standard sheet DKA 1-4a. Other current rating socket outlets shall be in compliance with by DS 60884-2-D1 Standard Sheet DKA 1-3a or DKA 1-3b.</p> <p>Justification the Heavy Current Regulations, 6c</p>		N/A
2.2.4	In Norway , for requirements see 1.7.2.1, 6.1.2.1 and 6.1.2.2 of this annex.		N/A
2.3.2	In Finland, Norway and Sweden there are additional requirements for the insulation. See 6.1.2.1 and 6.1.2.2 of this annex.	No TNV circuit.	N/A
2.3.4	In Norway , for requirements see 1.7.2.1, 6.1.2.1 and 6.1.2.2 of this annex.	No TNV circuit.	N/A
2.6.3.3	In the United Kingdom , the current rating of the circuit shall be taken as 13 A, not 16 A.		P
2.7.1	In the United Kingdom , to protect against excessive currents and short-circuits in the PRIMARY CIRCUIT of DIRECT PLUG-IN EQUIPMENT, tests according to 5.3 shall be conducted, using an external protective device rated 30 A or 32 A. If these tests fail, suitable protective devices shall be included as integral parts of the DIRECT PLUG-IN EQUIPMENT, so that the requirements of 5.3 are met.	Direct plug-in equipment.	P
2.10.5.13	In Finland, Norway and Sweden , there are additional requirements for the insulation, see 6.1.2.1 and 6.1.2.2 of this annex.	No TNV circuit.	N/A
3.2.1.1	<p>In Switzerland, supply cords of equipment having a RATED CURRENT not exceeding 10 A shall be provided with a plug complying with SEV 1011 or IEC 60884-1 and one of the following dimension sheets:</p> <p>SEV 6532-2.1991 Plug Type 15 3P+N+PE 250/400 V, 10 A</p>	Shall be evaluated when marketed in Switzerland.	N/A

IEC60950_1E - ATTACHMENT

Clause	Requirement + Test	Result - Remark	Verdict
--------	--------------------	-----------------	---------

Attachment 4 Deviation of EUROPEAN GROUP DIFFERENCES AND NATIONAL DIFFERENCES

<p align="center">ZB ANNEX (normative) SPECIAL NATIONAL CONDITIONS (EN)</p>			
Clause	Requirement + Test	Result - Remark	Verdict
	<p>SEV 6533-2.1991 Plug Type 11 L+N 250 V, 10 A</p> <p>SEV 6534-2.1991 Plug Type 12 L+N+PE 250 V, 10 A</p> <p>In general, EN 60309 applies for plugs for currents exceeding 10 A. However, a 16 A plug and socket-outlet system is being introduced in Switzerland, the plugs of which are according to the following dimension sheets, published in February 1998: SEV 5932-2.1998: Plug Type 25 , 3L+N+PE 230/400 V, 16 A</p> <p>SEV 5933-2.1998: Plug Type 21, L+N, 250 V, 16A</p> <p>SEV 5934-2.1998: Plug Type 23, L+N+PE 250 V, 16 A</p>		
3.2.1.1	<p>In Denmark, supply cords of single-phase equipment having a rated current not exceeding 13 A shall be provided with a plug according to the Heavy Current Regulations, Section 107-2-D1.</p> <p>CLASS I EQUIPMENT provided with socket-outlets with earth contacts or which are intended to be used in locations where protection against indirect contact is required according to the wiring rules shall be provided with a plug in accordance with standard sheet DK 2-1a or DK 2-5a.</p> <p>If poly-phase equipment and single-phase equipment having a RATED CURRENT exceeding 13 A is provided with a supply cord with a plug, this plug shall be in accordance with the Heavy Current Regulations, Section 107-2-D1 or EN 60309-2.</p>	<p>Shall be evaluated when marketed Denmark.</p>	N/A

IEC60950_1E - ATTACHMENT			
Clause	Requirement + Test	Result - Remark	Verdict

Attachment 4 Deviation of EUROPEAN GROUP DIFFERENCES AND NATIONAL DIFFERENCES

ZB ANNEX (normative) SPECIAL NATIONAL CONDITIONS (EN)			
Clause	Requirement + Test	Result - Remark	Verdict
3.2.1.1 (A2:2013)	<p>In Denmark, supply cords of single-phase equipment having a rated current not exceeding 13 A shall be provided with a plug according to DS 60884-2-D1.</p> <p>CLASS I EQUIPMENT provided with socket-outlets with earth contacts or which are intended to be used in locations where protection against indirect contact is required according to the wiring rules shall be provided with a plug in accordance with standard sheet DK 2-1a or DK 2-5a.</p> <p>If a single-phase equipment having a RATED CURRENT exceeding 13 A or if a poly-phase equipment is provided with a supply cord with a plug, this plug shall be in accordance with the standard sheets DK 6-1a in DS 60884-2-D1 or EN 60309-2.</p> <p>Justification the Heavy Current Regulations, 6c</p>	Shall be evaluated when marketed Denmark.	N/A
3.2.1.1	<p>In Spain, supply cords of single-phase equipment having a rated current not exceeding 10 A shall be provided with a plug according to UNE 20315:1994.</p> <p>Supply cords of single-phase equipment having a rated current not exceeding 2,5 A shall be provided with a plug according to UNE-EN 50075:1993.</p> <p>CLASS I EQUIPMENT provided with socket-outlets with earth contacts or which are intended to be used in locations where protection against indirect contact is required according to the wiring rules, shall be provided with a plug in accordance with standard UNE 20315:1994.</p> <p>If poly-phase equipment is provided with a supply cord with a plug, this plug shall be in accordance with UNE-EN 60309-2.</p>	Shall be evaluated when marketed Spain.	N/A
3.2.1.1	<p>In the United Kingdom, apparatus which is fitted with a flexible cable or cord and is designed to be connected to a mains socket conforming to BS 1363 by means of that flexible cable or cord and plug, shall be fitted with a 'standard plug' in accordance with Statutory Instrument 1768:1994 - The Plugs and Sockets etc. (Safety) Regulations 1994, unless exempted by those regulations.</p> <p>NOTE 'Standard plug' is defined in SI 1768:1994 and essentially means an approved plug conforming to BS 1363 or an approved conversion plug.</p>	Shall be evaluated when marketed United Kingdom.	N/A

IEC60950_1E - ATTACHMENT			
Clause	Requirement + Test	Result - Remark	Verdict

Attachment 4 Deviation of EUROPEAN GROUP DIFFERENCES AND NATIONAL DIFFERENCES

ZB ANNEX (normative) SPECIAL NATIONAL CONDITIONS (EN)			
Clause	Requirement + Test	Result - Remark	Verdict
3.2.1.1	In Ireland , apparatus which is fitted with a flexible cable or cord and is designed to be connected to a mains socket conforming to I.S. 411 by means of that flexible cable or cord and plug, shall be fitted with a 13 A plug in accordance with Statutory Instrument 525:1997 - National Standards Authority of Ireland (section 28) (13 A Plugs and Conversion Adaptors for Domestic Use) Regulations 1997.	Shall be evaluated when marketed in Ireland.	N/A
3.2.4	In Switzerland , for requirements see 3.2.1.1 of this annex.		N/A
3.2.5.1	In the United Kingdom , a power supply cord with conductor of 1,25 mm ² is allowed for equipment with a rated current over 10 A and up to and including 13 A.		N/A
3.3.4	In the United Kingdom , the range of conductor sizes of flexible cords to be accepted by terminals for equipment with a RATED CURRENT of over 10 A up to and including 13 A is: <ul style="list-style-type: none"> • 1,25 mm² to 1,5 mm² nominal cross-sectional area. 		N/A
4.3.6	In the United Kingdom , the torque test is performed using a socket outlet complying with BS 1363 part 1:1995, including Amendment 1:1997 and Amendment 2:2003 and the plug part of DIRECT PLUG-IN EQUIPMENT shall be assessed to BS 1363: Part 1, 12.1, 12.2, 12.3, 12.9, 12.11, 12.12, 12.13, 12.16 and 12.17, except that the test of 12.17 is performed at not less than 125 °C. Where the metal earth pin is replaced by an Insulated Shutter Opening Device (ISOD), the requirements of clauses 22.2 and 23 also apply.	Direct plug-in equipment.	P
4.3.6	In Ireland , DIRECT PLUG-IN EQUIPMENT is known as plug similar devices. Such devices shall comply with Statutory Instrument 526:1997 - National Standards Authority of Ireland (Section 28) (Electrical plugs, plug similar devices and sockets for domestic use) Regulations, 1997.	Shall be evaluated when marketed in Ireland.	N/A

IEC60950_1E - ATTACHMENT			
Clause	Requirement + Test	Result - Remark	Verdict

Attachment 4 Deviation of EUROPEAN GROUP DIFFERENCES AND NATIONAL DIFFERENCES

ZB ANNEX (normative) SPECIAL NATIONAL CONDITIONS (EN)			
Clause	Requirement + Test	Result - Remark	Verdict
5.1.7.1	<p>In Finland, Norway and Sweden TOUCH CURRENT measurement results exceeding 3,5 mA r.m.s. are permitted only for the following equipment:</p> <ul style="list-style-type: none"> • STATIONARY PLUGGABLE EQUIPMENT TYPE A that <ul style="list-style-type: none"> is intended to be used in a RESTRICTED ACCESS LOCATION where equipotential bonding has been applied, for example, in a telecommunication centre; and has provision for a permanently connected PROTECTIVE EARTHING CONDUCTOR; and is provided with instructions for the installation of that conductor by a SERVICE PERSON; • STATIONARY PLUGGABLE EQUIPMENT TYPE B; • STATIONARY PERMANENTLY CONNECTED EQUIPMENT. 		N/A
6.1.2.1 (A1:2010)	<p>In Finland, Norway and Sweden, add the following text between the first and second paragraph of the compliance clause:</p> <p>If this insulation is solid, including insulation forming part of a component, it shall at least consist of either</p> <ul style="list-style-type: none"> - two layers of thin sheet material, each of which shall pass the electric strength test below, or - one layer having a distance through insulation of at least 0,4 mm, which shall pass the electric strength test below. <p>Alternatively for components, there is no distance through insulation requirements for the insulation consisting of an insulating compound completely filling the casing, so that CLEARANCES and CREEPAGE DISTANCES do not exist, if the component passes the electric strength test in accordance with the compliance clause below and in addition</p> <ul style="list-style-type: none"> - passes the tests and inspection criteria of 2.10.11 with an electric strength test of 1,5 kV multiplied by 1,6 (the electric strength test of 2.10.10 shall be performed using 1,5 kV), and - is subject to ROUTINE TESTING for electric strength during manufacturing, using a test voltage of 1,5 kV. 	No TNV circuit.	N/A

IEC60950_1E - ATTACHMENT			
Clause	Requirement + Test	Result - Remark	Verdict

Attachment 4 Deviation of EUROPEAN GROUP DIFFERENCES AND NATIONAL DIFFERENCES

ZB ANNEX (normative) SPECIAL NATIONAL CONDITIONS (EN)			
Clause	Requirement + Test	Result - Remark	Verdict
	<p>It is permitted to bridge this insulation with an optocoupler complying with 2.10.5.4 b).</p> <p>It is permitted to bridge this insulation with a capacitor complying with EN 60384-14:2005, subclass Y2.</p> <p>A capacitor classified Y3 according to EN 60384-14:2005, may bridge this insulation under the following conditions:</p> <ul style="list-style-type: none"> - the insulation requirements are satisfied by having a capacitor classified Y3 as defined by EN 60384-14, which in addition to the Y3 testing, is tested with an impulse test of 2,5 kV defined in EN 60950-1:2006, 6.2.2.1; - the additional testing shall be performed on all the test specimens as described in EN 60384-14: - the impulse test of 2,5 kV is to be performed before the endurance test in EN 60384-14, in the sequence of tests as described in EN 60384-14. 	No TNV circuit.	N/A
6.1.2.2	In Finland, Norway and Sweden , the exclusions are applicable for PERMANENTLY CONNECTED EQUIPMENT, PLUGGABLE EQUIPMENT TYPE B and equipment intended to be used in a RESTRICTED ACCESS LOCATION where equipotential bonding has been applied, e.g. in a telecommunication centre, and which has provision for a permanently connected PROTECTIVE EARTHING CONDUCTOR and is provided with instructions for the installation of that conductor by a SERVICE PERSON.	No TNV circuit.	N/A
7.2	In Finland, Norway and Sweden , for requirements see 6.1.2.1 and 6.1.2.2 of this annex. The term TELECOMMUNICATION NETWORK in 6.1.2 being replaced by the term CABLE DISTRIBUTION SYSTEM.	Not intended to be connected to cable distribution system.	N/A
7.3 (A11:2009)	In Norway and Sweden , for requirements see 1.2.13.14 and 1.7.2.1 of this annex.	Not intended to be connected to cable distribution system.	N/A

IEC60950_1E - ATTACHMENT			
Clause	Requirement + Test	Result - Remark	Verdict

**Attachment 4 Deviation of EUROPEAN GROUP DIFFERENCES AND NATIONAL DIFFERENCES
Annex ZD
(informative)**

IEC and CENELEC code designations for flexible cords

Type of flexible cord	Code designations	
	IEC	CENELEC
PVC insulated cords		
Flat twin tinsel cord	60227 IEC 41	H03VH-Y
Light polyvinyl chloride sheathed flexible cord	60227 IEC 52	H03VV-F H03VVH2-F
Ordinary polyvinyl chloride sheathed flexible cord	60277 IEC 53	H05VV-F H05VVH2-F
Rubber insulated cords		
Braided cord	60245 IEC 51	H03RT-F
Ordinary tough rubber sheathed flexible cord	60245 IEC 53	H05RR-F
Ordinary polychloroprene sheathed flexible cord	60245 IEC 57	H05RN-F
Heavy polychloroprene sheathed flexible cord	60245 IEC 66	H07RN-F
Cords having high flexibility		
Rubber insulated and sheathed cord	60245 IEC 86	H03RR-H
Rubber insulated, crosslinked PVC sheathed cord	60245 IEC 87	H03RV4-H
Crosslinked PVC insulated and sheathed cord	60245 IEC 88	H03V4V4-H

*****End of Attachment 4*****

Attachment 5 Deviations of Australia and/or New Zealand

Sub-clause	Variations to IEC 60950-1:2005 +A1:2009 for application in Australia and/or New Zealand (AS/NZS 60950.1:2011 +A1:2012)	Verdict																										
ZZ1	This Appendix sets out variations and additional requirements to cover issues which have not been addressed by the International Standard. These variations indicate national variations for purposes of the IEC EE CB System and will be published in the IEC EE CB Bulletin.	-																										
ZZ2	The variations are as follows:	-																										
1.2.12.201	Add the definition of "POTENTIAL IGNITION SOURCE"	Noted																										
1.5.1	Add the following to the end of the first paragraph: 'or the relevant Australian/New Zealand Standard.' In Note 1, add the following after the word 'standard': 'or an Australian/New Zealand Standard.'	P																										
1.5.2	Add the following to the end of the first and third dash items: 'or the relevant Australian/New Zealand Standard'	P																										
3.2.5.1	Modify Table 3B as follows: Delete the first four rows and replace with <table border="1" style="margin: 10px auto; border-collapse: collapse;"> <thead> <tr> <th rowspan="3" style="text-align: center;">RATED CURRENT of equipment A</th> <th colspan="3" style="text-align: center;">Minimum conductor sizes</th> </tr> <tr> <th style="text-align: center;">Nominal cross-sectional area</th> <th colspan="2" style="text-align: center;">AWG or kcmil [cross-sectional area in mm²]</th> </tr> <tr> <th style="text-align: center;">mm²</th> <th colspan="2" style="text-align: center;">see Note 2</th> </tr> </thead> <tbody> <tr> <td style="text-align: center;">Over 0.2 up to and including 3</td> <td style="text-align: center;">0,5 ^a</td> <td style="text-align: center;">18</td> <td style="text-align: center;">[0,8]</td> </tr> <tr> <td style="text-align: center;">Over 3 up to and including 7.5</td> <td style="text-align: center;">0,75</td> <td style="text-align: center;">16</td> <td style="text-align: center;">[1,3]</td> </tr> <tr> <td style="text-align: center;">Over 7.5 up to and including 10</td> <td style="text-align: center;">(0,75) ^b</td> <td style="text-align: center;">1,00</td> <td style="text-align: center;">16 [1,3]</td> </tr> <tr> <td style="text-align: center;">Over 10 up to and including 16</td> <td style="text-align: center;">(1,0) ^c</td> <td style="text-align: center;">1,5</td> <td style="text-align: center;">14 [2]</td> </tr> </tbody> </table>	RATED CURRENT of equipment A	Minimum conductor sizes			Nominal cross-sectional area	AWG or kcmil [cross-sectional area in mm ²]		mm ²	see Note 2		Over 0.2 up to and including 3	0,5 ^a	18	[0,8]	Over 3 up to and including 7.5	0,75	16	[1,3]	Over 7.5 up to and including 10	(0,75) ^b	1,00	16 [1,3]	Over 10 up to and including 16	(1,0) ^c	1,5	14 [2]	N/A
RATED CURRENT of equipment A	Minimum conductor sizes																											
	Nominal cross-sectional area		AWG or kcmil [cross-sectional area in mm ²]																									
	mm ²	see Note 2																										
Over 0.2 up to and including 3	0,5 ^a	18	[0,8]																									
Over 3 up to and including 7.5	0,75	16	[1,3]																									
Over 7.5 up to and including 10	(0,75) ^b	1,00	16 [1,3]																									
Over 10 up to and including 16	(1,0) ^c	1,5	14 [2]																									
	replace footnote a) and replace with the following: a) This nominal cross-sectional area is only allowed for Class II appliances if the length of the power supply cord, measured between the point where the cord, or cord guard, enters the appliance, and the entry to the plug does not exceed 2 m (0,5 mm ² three-core supply flexible cords are not permitted; see AS/NZS 3191).	N/A																										
	Delete Note 1.	N/A																										
4.1.201	Insert a new Clause 4.1.201 after Clause 4.1 as follows: 4.1.201 Display devices used for television purposes	N/A																										
	Display devices which may be used for television purposes, with a mass of 7 kg or more, shall comply with the requirements for stability and mechanical hazards, including the additional stability requirements for television receivers, specified in AS/NZS 60065.	N/A																										

Attachment 5 Deviations of Australia and/or New Zealand

Sub-clause	Variations to IEC 60950-1:2005 +A1:2009 for application in Australia and/or New Zealand (AS/NZS 60950.1:2011 +A1:2012)	Verdict
4.3.6	<p>Delete the third paragraph and replace with the following:</p> <p>Equipment with a plug portion, suitable for insertion into a 10 A 3-pin flat-pin socket-outlet complying with AS/NZS 3112 shall comply with the requirements in AS/NZS 3112 for equipment with integral pins for insertion into socket-outlets.</p>	See annex 6 for details P
4.3.13.5	<p>Add the following after each reference to 'IEC 60825-1':</p> <p>' , or AS/NZS 60825.1.'</p>	N/A
	<p>Add the following after 'IEC 60825-2' in line two of the first paragraph:</p> <p>'or AS/NZS 60825.2'</p>	N/A
4.7	<p>Add the following paragraph:</p> <p>For alternative tests refer to Clause 4.7.201.</p>	P
4.7.201	<p>Add the following after clause 4.7.3.6</p> <p>Resistance to fire — Alternative tests</p>	P
4.7.201.1	<p>Parts of non-metallic material shall be resistant to ignition and the spread of fire</p>	P
	<p>This requirement does not apply to decorative trims, knobs and other parts unlikely to be ignited or to propagate flames originating from inside the apparatus, or the following:</p>	P
	<p>a) Components that are contained in an enclosure having a flammability category of V-0 according to AS/NZS 60695.11.10 and having openings only for the connecting wires filling the openings completely, and for ventilation not exceeding 1mm in width regardless of length.</p>	P
	<p>b) The following parts which would contribute negligible fuel to a fire:</p>	P
	<p>- small mechanical parts, the mass of which does not exceed 4 g, such as mounting parts, gears, cams, belts and bearings;</p>	P
	<p>- small electrical components, such as capacitors with a volume not exceeding 1 750 mm³, integrated circuits, transistors and optocoupler packages, if these components are mounted on material of flammability category V-1 or better, according to AS/NZS 60695.11.10.</p>	P
	<p>NOTE – In considering how to minimize propagation of fire and what 'small parts' are, account should be taken of the cumulative effect of small parts adjacent to each other for the possible effect of propagating fire from one part to another.</p>	P

Attachment 5 Deviations of Australia and/or New Zealand

Sub-clause	Variations to IEC 60950-1:2005 +A1:2009 for application in Australia and/or New Zealand (AS/NZS 60950.1:2011 +A1:2012)	Verdict
	Compliance shall be checked by the tests of 4.7.201.2, 4.7.201.3, 4.7.201.4 and 4.7.201.5 For the base material of printed boards, compliance shall be checked by the test of 4.7.201.5.	N/A
	The tests shall be carried out on parts of non-metallic material which have been removed from the apparatus.	N/A
	When the glow-wire test is carried out, they are placed in the same orientation as they would be in normal use.	N/A
	These tests are not carried out on internal wiring.	N/A
4.7.201.2	Parts of non-metallic material shall be subject to the glow-wire test of AS/NZS 60695.2.11 which shall be carried out at 550°C.	N/A
	Parts for which the glow-wire test cannot be carried out, such as those made of soft or foamy material, shall meet the requirements specified in ISO 9772 for category FH-3 material. The glow-wire test shall not be carried out on parts of material classified at least FH-3 according to ISO 9772 provided that the sample tested was not thicker than the relevant part.	N/A
4.7.201.3	Part of insulating material supporting potential ignition sources shall be subject to the glow-wire test of AS/NZS 60695.2.11 which shall be carried out at 750°C.	N/A
	The test shall be also carried out on other parts of insulating material which are within a distance of 3 mm of the connection	N/A
	NOTE – Contacts in components such as switch contacts are considered to be connections.	N/A
	For parts which withstand the glow-wire test but produce a flame, other parts above the connection within the envelope of a vertical cylinder having a diameter of 20 mm and a height of 50 mm shall be subjected to the needle-flame test.	N/A
	However, parts shielded by a barrier which meets the needle-flame test need not be tested.	N/A

Attachment 5 Deviations of Australia and/or New Zealand

Sub-clause	Variations to IEC 60950-1:2005 +A1:2009 for application in Australia and/or New Zealand (AS/NZS 60950.1:2011 +A1:2012)	Verdict										
	<p>The needle-flame test shall be made in accordance with AS/NZS 60695.11.5 with the following modifications:</p> <table border="1" style="width: 100%; border-collapse: collapse;"> <thead> <tr> <th style="text-align: left;">Clause of AS/NZS 60695.11.5</th> <th style="text-align: left;">Change</th> </tr> </thead> <tbody> <tr> <td colspan="2">9 Test procedure</td> </tr> <tr> <td>9.2 Application of needle-flame</td> <td> <p>Replace the first paragraph with:</p> <p>The specimen shall be arranged so that the flame can be applied to a vertical or horizontal edge as shown in the examples of figure 1. If possible the flame shall be applied at least 10 mm from a corner</p> <p>Replace the second paragraph with:</p> <p>The duration of application of the test flame shall be 30 s ± 1 s.</p> </td> </tr> <tr> <td>9.3 Number of test specimens</td> <td> <p>Replace with:</p> <p>The test shall be made on one specimen. If the specimen does not withstand the test, the test may be repeated on two further specimens, both of which shall withstand the test.</p> </td> </tr> <tr> <td>11 Evaluation of test results</td> <td> <p>Replace with:</p> <p>The duration of burning (t_b) shall not exceed 30 s. However, for printed circuit boards, it shall not exceed 15 s.</p> </td> </tr> </tbody> </table>	Clause of AS/NZS 60695.11.5	Change	9 Test procedure		9.2 Application of needle-flame	<p>Replace the first paragraph with:</p> <p>The specimen shall be arranged so that the flame can be applied to a vertical or horizontal edge as shown in the examples of figure 1. If possible the flame shall be applied at least 10 mm from a corner</p> <p>Replace the second paragraph with:</p> <p>The duration of application of the test flame shall be 30 s ± 1 s.</p>	9.3 Number of test specimens	<p>Replace with:</p> <p>The test shall be made on one specimen. If the specimen does not withstand the test, the test may be repeated on two further specimens, both of which shall withstand the test.</p>	11 Evaluation of test results	<p>Replace with:</p> <p>The duration of burning (t_b) shall not exceed 30 s. However, for printed circuit boards, it shall not exceed 15 s.</p>	N/A
Clause of AS/NZS 60695.11.5	Change											
9 Test procedure												
9.2 Application of needle-flame	<p>Replace the first paragraph with:</p> <p>The specimen shall be arranged so that the flame can be applied to a vertical or horizontal edge as shown in the examples of figure 1. If possible the flame shall be applied at least 10 mm from a corner</p> <p>Replace the second paragraph with:</p> <p>The duration of application of the test flame shall be 30 s ± 1 s.</p>											
9.3 Number of test specimens	<p>Replace with:</p> <p>The test shall be made on one specimen. If the specimen does not withstand the test, the test may be repeated on two further specimens, both of which shall withstand the test.</p>											
11 Evaluation of test results	<p>Replace with:</p> <p>The duration of burning (t_b) shall not exceed 30 s. However, for printed circuit boards, it shall not exceed 15 s.</p>											
	<p>The needle-flame test shall not be carried out on parts of material classified as V-0 or V-1 according to AS/NZS 60695.11.10, provided that the sample tested was not thicker than the relevant part.</p>	N/A										
4.7.201.4	<p>If parts, other than enclosures, do not withstand the glow wire tests of 4.7.201.3, by failure to extinguish within 30 s after the removal of the glow-wire tip, the needle-flame test detailed in 4.7.201.3 shall be made on all parts of non-metallic material which are within a distance of 50 mm or which are likely to be impinged upon by flame during the tests of 4.7.201.3. Parts shielded by a separate barrier which meets the needle-flame test shall not be tested.</p>	N/A										
	<p>NOTE 1 – If the enclosure does not withstand the glow-wire test the appliance is considered to have failed to meet the requirements of Clause 4.7.201 without the need for consequential testing.</p>	N/A										
	<p>NOTE 2 – If other parts do not withstand the glow-wire test due to ignition of the tissue paper and if this indicates that burning or glowing particles can fall onto an external surface underneath the apparatus, the apparatus is considered to have failed to meet the requirements of Clause 4.7.201 without the need for consequential testing</p>	N/A										

Attachment 5 Deviations of Australia and/or New Zealand

Sub-clause	Variations to IEC 60950-1:2005 +A1:2009 for application in Australia and/or New Zealand (AS/NZS 60950.1:2011 +A1:2012)	Verdict
	NOTE 3 – Parts likely to be impinged upon by the flame are considered to be those within the envelope of a vertical cylinder having a radius of 10 mm and a height equal to the height of the flame, positioned above the point of the material supporting, in contact with, or in close proximity to, connections.	N/A
4.7.201.5	The base material of printed boards shall be subject to the needle-flame test of Clause 4.7.201.3.	N/A
	The flame shall be applied to the edge of the board where the heat sink effect is lowest when the board is positioned as in normal use. The flame shall not be applied to an edge consisting of broken perforations, unless the edge is less than 3 mm from a potential ignition source.	N/A
	The test is not carried out if:	P
	- the printed board does not carry any potential ignition source	N/A
	- base material of printed boards, on which the available power at a connection exceeds 15 VA operating at a voltage exceeding 50 V and equal or less than 400 V (peak) a.c. or d.c. under normal operating conditions, is of flammability category V-1 or better according to AS/NZS 60695.11.10, or the printed boards are protected by an enclosure meeting the flammability category V-0 according to AS/NZS 60695.11.10, or made of metal, having openings only for connecting wires which fill the openings completely	P
	- base material of printed boards, on which the available power at a connection exceeds 15 VA operating at a voltage exceeding 400 V (peak) a.c. or d.c. under normal operating conditions, and base material of printed boards supporting spark gaps which provides protection against overvoltages, is of flammability category V-0 according to AS/NZS 60695.11.10	P
	- the printed boards are contained in a metal enclosure, having openings only for connecting wires which fill the openings completely	N/A
	Compliance shall be determined using the smallest thickness of the material. NOTE – Available apparent power is the maximum apparent power which can be drawn from the supplying circuit through a resistive load whose value is chosen to maximise the apparent power for more than 2 min when the circuit supplied is disconnected.	N/A
6.2.2	For Australia only, delete the first paragraph and Note, and replace with the following:	N/A

Attachment 5 Deviations of Australia and/or New Zealand

Sub-clause	Variations to IEC 60950-1:2005 +A1:2009 for application in Australia and/or New Zealand (AS/NZS 60950.1:2011 +A1:2012)	Verdict
	In Australia only, compliance with 6.2.2 shall be checked by the tests of both 6.2.2.1 and 6.2.2.2.	N/A
6.2.2.1	For Australia only, delete the first paragraph including the Notes, and replace with the following:	N/A
	In Australia only, the electrical separation is subjected to 10 impulses of alternating polarity, using the impulse test generator reference 1 of annex N. The interval between successive impulses is 60 s and the initial voltage, U_c , is: for 6.2.1 a): 7.0 kV for hand-held telephones and for headsets and 2.5 kV for other equipment; and for 6.2.1 b) and 6.2.1 c): 1.5 kV.	N/A
	NOTE 201 – The 7 kV impulse simulates lightning surges on typical rural and semi-rural network lines. NOTE 202 – The value of 2.5 kV for 6.2.1 a) was chosen to ensure the adequacy of the insulation concerned and does not necessarily simulate likely overvoltages.	N/A
6.2.2.2	For Australia only, delete the second paragraph including the Note, and replace with the following:	N/A
	In Australia only, the a.c. test voltage is: for 6.2.1 a): 3 kV; and for 6.2.1 b) and 6.2.1 c): 1.5 kV.	N/A
	NOTE 201 – Where there are capacitors across the insulation under test, it is recommended that d.c. test voltages are used. NOTE 202 – The 3 kV and 1.5 kV values have been determined considering the low frequency induced voltages from the power supply distribution system.	N/A
7.3	Add the following before the first paragraph: Equipment providing functions that fall only within the scope of AS/NZS 60065 and that incorporate a PSTN interface, are not required to comply with this Clause where the only ports provided on the equipment, in addition to a coaxial cable connection and a PSTN interface, are audio or video ports and analogue or data ports not intended to be used for telecommunications purposes.	N/A
Annex P	Add the following Normative References: AS/NZS 3191, Electric flexible cords AS/NZS 3112, Approval and test specification—Plugs and socket-outlets	P

Attachment 5 Deviations of Australia and/or New Zealand

Sub-clause	Variations to IEC 60950-1:2005 +A1:2009 for application in Australia and/or New Zealand (AS/NZS 60950.1:2011 +A1:2012)	Verdict
Index	<p>1. <i>Insert</i> the following between 'asbestos, not to be used as insulation' and 'attitude see orientation':</p> <p>AS/NZS 3112 4.3.6 AS/NZS 3191 3.2.5.1 (Table 3B) AS/NZS 60064 4.1.201 AS/NZS 60695.2.11 4.7.201.2, 4.7.201.3 AS/NZS 60695.11.10 4.7.201.1, 4.7.201.5 AS/NZS 60695.11.5 4.7.201.3 AS/NZS 60825.1 4.3.13.5.1 AS/NZS 60825.2 4.3.13.5.1'</p> <p>2. <i>Insert</i> the following between 'positive temperature coefficient (PTC) device' and 'powder':</p> <p>potential ignition source 1.2.201, 4.7.201.3, 4.7.201.5</p>	P

*****End of Attachment 5*****

Attachment 6 Deviations of Korea

Sub-clause	Variations to IEC 60950-1:2005 for application in Korea (K60950-1)		Verdict
1.5.101	Addition Plugs for the connection of the apparatus to the supply mains shall comply with the Korean requirement (KSC 8305).	The plug portion shall be evaluated when submitted for national approval.	N/A
8 EMC	Addition The apparatus shall comply with the relevant CISPR standards	The EMC for Korean deviations is not evaluated.	N/A

*****End of Attachment 6*****

IEC 60950-1 ATTACHMENT			
Clause	Requirement + Test	Result - Remark	Verdict

Attachment 7 Deviation of JAPAN

ATTACHMENT TO TEST REPORT IEC 60950-1 JAPAN NATIONAL DIFFERENCES Information technology equipment – Safety – Part 1: General requirements			
Differences according to: J60950-1(H22)			
Attachment Form No.: JP_ND_IEC60950_1A			
Attachment Originator: --			
Master Attachment: 2010-11			
Copyright © 2010 IEC System for Conformity Testing and Certification of Electrical Equipment (IECEE), Geneva, Switzerland. All rights reserved.			

National Differences - Japan			
1.2.4.1	Add the following new NOTE. NOTE Even if the equipment is designed as Class I, the equipment is regarded as Class 0I equipment when a 2-pin adaptor with an earthing lead wire or a cord set having a 2-pin plug with an earthing lead wire is provided or recommended.		N/A
1.2.4.3A	Add the following new clause. 1.2.4.3A CLASS 0I EQUIPMENT Equipment having attachment plug without earthing blade, where protection against electric shock is achieved by: <ul style="list-style-type: none"> - using BASIC INSULATION, and - providing externally an earth terminal or a lead wire for earthing in order to connect those conductive parts that might assume a HAZARDOUS VOLTAGES in the event of BASIC INSULATION fault to the PROTECTIVE EARTHING CONDUCTOR in the building wiring. NOTE Class 0I equipment may have a part constructed with Double Insulation or Reinforced Insulation. circuit.		N/A

IEC 60950-1 ATTACHMENT			
Clause	Requirement + Test	Result - Remark	Verdict

Attachment 7 Deviation of JAPAN

1.3.2	<p>Add the following notes after the first paragraph:</p> <p>NOTE 1 Transportable or similar equipment that is relocated frequently for intended usage should not be designed as Class I or Class 0I equipment unless it is intended to be installed by service personnel.</p> <p>NOTE 2 Considering wiring circumstance in Japan, equipment intended to be installed where the provision for earthing connection is unlikely should not be designed as Class I or Class 0I equipment unless it is intended to be installed by service personnel.</p>		N/A
1.5.1	<p>Replace the first paragraph with the following:</p> <p>Where safety is involved, components shall comply either with the requirements of this standard or with the safety aspects of the relevant JIS component standard or IEC component standards in case there is no applicable JIS component standard is available. However, in case a component that falls within the scope of the METI Ministerial ordinance (No. 85:1962) is properly used in accordance with its marked ratings, the requirements of 1.5.4, 2.8.7 and 3.2.5 apply, and in addition, a cord connector of power supply cord set matching with an appliance inlet specified in the standard sheets of IEC 60320-1, shall comply with relevant standard sheet of IEC 60320-1.</p> <p>Replace NOTE 1 with the following:</p> <p>NOTE 1 A JIS or an IEC component standard is considered relevant only if the component in question clearly falls within its scope.</p>		P

IEC 60950-1 ATTACHMENT			
Clause	Requirement + Test	Result - Remark	Verdict
<u>Attachment 7 Deviation of JAPAN</u>			
1.5.2	<p>Replace the first sentence in the first dashed paragraph with the following:</p> <ul style="list-style-type: none"> - a component that has been demonstrated to comply with a JIS component standard harmonized with the relevant IEC component standard, or where such JIS component standard is not available, a component that has been demonstrated to comply with the relevant IEC component standard shall be checked for correct application and use in accordance with its rating. <p>Add a NOTE after the first dashed paragraph as follows:</p> <p>NOTE 1 See 1.7.5A when Type C.14 appliance coupler rated 10 A per IEC 60320-1 is used with an equipment rated not more than 125 V and rated more than 10 A.</p> <p>Replace the first sentence in the third dashed paragraph as follows:</p> <ul style="list-style-type: none"> - where no relevant IEC component standard or JIS component standard harmonized with the relevant IEC component standard exists, or where components are used in circuits not in accordance with their specified rating, the components shall be tested under the conditions occurring in the equipment. 		P
1.5.6	In this sub-clause, add "JIS C 5101-14:1998 or" before the reference number, IEC 60384-14:1993.		P
1.5.7.2	In this sub-clause, add "JIS C 5101-14:1998 or" before the reference number, IEC 60384-14:1993.		N/A
1.5.8	In the first paragraph, add "JIS C 5101-14:1998 or" before the reference number, IEC 60384-14:1993.		N/A
1.7.1	<p>Replace the fifth dashed paragraph with the following:</p> <ul style="list-style-type: none"> - manufacturer's or responsible company's name or trade-mark or identification mark; 		P
1.7.5	In the second paragraph, add "or JIS C 8303:2007" after the reference number, IEC/TR 60083:1997".		N/A

IEC 60950-1 ATTACHMENT			
Clause	Requirement + Test	Result - Remark	Verdict

Attachment 7 Deviation of JAPAN

1.7.5A	<p>Add the following new clause after 1.7.5</p> <p>1.7.5A Appliance Couplers</p> <p>If an appliance coupler according to IEC 60320-1, C.14(rated current: 10 A) is used in equipment whose rated voltage is less than 125 V and the rated current is over 10 A, the following instruction or equivalent shall be described in the user instruction.</p> <p>“ Use only designated cord set attached in this equipment”</p>		N/A
1.7.12	<p>Replace first sentence with the following:</p> <p>Instructions and equipment marking related to safety shall be in Japanese.</p>		N/A
1.7.17A	<p>Add the following new clause after 1.7.17</p> <p>1.7.17A Marking for CLASS 0I EQUIPMENT</p> <p>For CLASS 0I EQUIPMENT, the following instruction shall be marked on the visible place of the mains plug or the main body:</p> <p>必ず接地接続を行って下さい “Provide an earthing connection”</p> <p>Moreover, for CLASS 0I EQUIPMENT, the following or equivalent instruction shall be indicated on the visible place of the main body or written in the operating instructions:</p> <p>接地接続は必ず、電源プラグを電源につなぐ前に行って下さい。又、接地接続を外す場合は、必ず電源プラグを電源から切り離してから行って下さい。 “Provide an earthing connection before the mains plug is connected to the mains. And, when disconnecting the earthing connection, be sure to disconnect after pulling out the mains plug from the mains.”</p>		N/A
2.1.1.1	<p>In item b) of this sub-clause, replace “IEC 60083” with “JIS C 8303:2007 or Article 1 of the Ministerial Ordinance (No. 85:1962)”</p>	•	N/A
2.6.3.2	<p>Add the following after the first paragraph.</p> <p>This also applies to the conductor of lead wire for protective earthing of CLASS 0I EQUIPMENT.</p>	•	N/A

IEC 60950-1 ATTACHMENT			
Clause	Requirement + Test	Result - Remark	Verdict
<u>Attachment 7 Deviation of JAPAN</u>			
2.6.4.2	<p>Replace the first paragraph with the following.</p> <p>Equipment required to have protective earthing shall have a main protective earthing terminal. For equipment with a DETACHABLE POWER SUPPLY CORD, the earthing terminal in the appliance inlet is regarded as the main protective earthing terminal except for CLASS 0I EQUIPMENT providing separate main protective earthing terminal other than appliance inlet.</p>		N/A
2.6.5.4	<p>Replace the first sentence with the following.</p> <p>Protective earthing connections of CLASS I EQUIPMENT shall make earlier and break later than the supply connections in each of the following:</p>		N/A
2.6.5.8A	<p>Add the following new clause after 2.6.5.8</p> <p>2.6.5.8A Earthing of CLASS 0I EQUIPMENT Plugs with a lead wire for earthing shall not be used for equipment having a rated voltage exceeding 150 V. For plugs with a lead wire for earthing, the lead wire shall not be earthed by a clip. CLASS 0I EQUIPMENT shall be provided with an earthing terminal or a lead wire for earthing in the external location where easily visible.</p>		N/A
2.10.3.1	In this sub-clause, replace IEC 60664-1 with JIS C 0664:2003.		P
2.10.3.2	In the second paragraph, replace IEC 60664-1 with JIS C 0664:2003.		P
3.2.3	<p>Add the following after Table 3A:</p> <p>Table 3A applies when cables complying with JIS C 3662 or JIS C 3663 are used. In case of other cables, the cable entries shall be so designed that a conduit suitable for the cable used can be fitted.</p>		N/A

IEC 60950-1 ATTACHMENT			
Clause	Requirement + Test	Result - Remark	Verdict
<u>Attachment 7 Deviation of JAPAN</u>			
3.2.5.1	<p>Add the following to the last of first dashed paragraph.</p> <p>Or mains cords shall be of the sheathed type complying with Appendix 1 of Article 1 of the Ministerial Ordinance (No. 85:1962) on stipulating technical requirements for the Electrical Appliance.</p> <p>Add the following to the last of second dashed paragraph.</p> <p>Or mains cords shall be of the sheathed type complying with Appendix 1 of Article 1 of the Ministerial Ordinance (No. 85:1962) on stipulating technical requirements for the Electrical Appliance.</p> <p>Delete 1) in Table 3B.</p>		N/A
3.3.4	<p>Add the following note to Table 3D:</p> <p>NOTE For cables other than those complying with JIS C 3662 or JIS C 3663, terminals shall be suitable for the size of the intended cables.</p>		N/A
3.3.7	<p>Add the following after the first sentence:</p> <p>This requirement is not applicable to the external earthing terminal of Class 0I equipment.</p>		N/A
4.3.4	<p>Add the following after the first sentence:</p> <p>This requirement also applies to those connections in Class 0I equipment, where CLEARANCE or CREEPAGE DISTANCES over BASIC INSULATION would be reduced to less than the values specified in 2.10.</p>		N/A
4.3.13.5	<p>Replace the first paragraph with the following:</p> <p>Except as permitted below, equipment shall be classified and labelled according to JIS C 6802:2005, and JIS C 6803:2006 or IEC 60825-2:2000, as applicable.</p> <p>Replace IEC 60825-1 in the second and the last paragraph with JIS C 6802:2005.</p>		N/A

IEC 60950-1 ATTACHMENT			
Clause	Requirement + Test	Result - Remark	Verdict

Attachment 7 Deviation of JAPAN

4.5	<p>Add the following NOTE to Table 4B, 3):</p> <p>NOTE: In case no data for the material is available, Appendix 4, 4. (1). b. 3 of the Interpretation on the Ministerial Ordinance stipulating Technical Specifications for Electrical Appliances (Commerce and Distribution Policy Group No. 3:2008/06/19) may apply.</p>		P																												
5.1.3	<p>Add a note after the first paragraph as follows:</p> <p>NOTE Attention should be drawn to that majority of three-phase power system in Japan is of delta connection, and therefore, in that case, the test is conducted using the test circuit from IEC 60990, figure 13.</p>		N/A																												
5.1.6	<p>Replace Table 5A as follows:</p> <table border="1" style="width: 100%; border-collapse: collapse; margin: 10px 0;"> <thead> <tr> <th style="width: 30%;">Type of equipment</th> <th style="width: 30%;">Terminal A of measuring instrument connected to:</th> <th style="width: 15%;">Maximum TOUCH CURRENT mA r.m.s. ¹⁾</th> <th style="width: 25%;">Maximum PROTECTIVE CONDUCTOR CURRENT</th> </tr> </thead> <tbody> <tr> <td>All equipment</td> <td>Accessible parts and circuits not connected to protective earth</td> <td style="text-align: center;">0,25</td> <td style="text-align: center;">-</td> </tr> <tr> <td>HAND-HELD</td> <td rowspan="4">Equipment main protective earthing terminal (if any) CLASS I EQUIPMENT</td> <td style="text-align: center;">0,75</td> <td style="text-align: center;">-</td> </tr> <tr> <td>MOVABLE (other than HAND-HELD, but including TRANSPORTABLE EQUIPMENT</td> <td style="text-align: center;">3,5</td> <td style="text-align: center;">-</td> </tr> <tr> <td>STATIONARY, PLUGGABLE TYPE A</td> <td style="text-align: center;">3,5</td> <td style="text-align: center;">-</td> </tr> <tr> <td>All other STATIONARY EQUIPMENT - not subject to the conditions of 5.1.7 - subject to the conditions of 5.1.7</td> <td style="text-align: center;">3,5 -</td> <td style="text-align: center;">- 5 % of input current</td> </tr> <tr> <td>HAND-HELD</td> <td rowspan="2">Equipment main protective earthing terminal (if any) CLASS 0I EQUIPMENT</td> <td style="text-align: center;">0,5</td> <td style="text-align: center;">-</td> </tr> <tr> <td>Others</td> <td style="text-align: center;">1,0</td> <td style="text-align: center;">-</td> </tr> </tbody> </table> <p>¹⁾ If peak values of TOUCH-CURRENT are measured, the maximum values obtained by multiplying the r.m.s. values by 1,414.</p>	Type of equipment	Terminal A of measuring instrument connected to:	Maximum TOUCH CURRENT mA r.m.s. ¹⁾	Maximum PROTECTIVE CONDUCTOR CURRENT	All equipment	Accessible parts and circuits not connected to protective earth	0,25	-	HAND-HELD	Equipment main protective earthing terminal (if any) CLASS I EQUIPMENT	0,75	-	MOVABLE (other than HAND-HELD, but including TRANSPORTABLE EQUIPMENT	3,5	-	STATIONARY, PLUGGABLE TYPE A	3,5	-	All other STATIONARY EQUIPMENT - not subject to the conditions of 5.1.7 - subject to the conditions of 5.1.7	3,5 -	- 5 % of input current	HAND-HELD	Equipment main protective earthing terminal (if any) CLASS 0I EQUIPMENT	0,5	-	Others	1,0	-		P
Type of equipment	Terminal A of measuring instrument connected to:	Maximum TOUCH CURRENT mA r.m.s. ¹⁾	Maximum PROTECTIVE CONDUCTOR CURRENT																												
All equipment	Accessible parts and circuits not connected to protective earth	0,25	-																												
HAND-HELD	Equipment main protective earthing terminal (if any) CLASS I EQUIPMENT	0,75	-																												
MOVABLE (other than HAND-HELD, but including TRANSPORTABLE EQUIPMENT		3,5	-																												
STATIONARY, PLUGGABLE TYPE A		3,5	-																												
All other STATIONARY EQUIPMENT - not subject to the conditions of 5.1.7 - subject to the conditions of 5.1.7		3,5 -	- 5 % of input current																												
HAND-HELD	Equipment main protective earthing terminal (if any) CLASS 0I EQUIPMENT	0,5	-																												
Others		1,0	-																												
6	Replace IEC 60664-1 in NOTE 4 with JIS C 0664.		N/A																												
7	Replace IEC 60664-1 in NOTE 3 with JIS C 0664:2003.		N/A																												

IEC 60950-1 ATTACHMENT			
Clause	Requirement + Test	Result - Remark	Verdict
<u>Attachment 7 Deviation of JAPAN</u>			
7.2	<p>Add the following after the paragraph:</p> <p>However, the separation requirements and tests of 6.2.1 a), b) and c) do not apply to a CABLE DISTRIBUTION SYSTEM if all of the following apply:</p> <ul style="list-style-type: none"> - the circuit under consideration is a TNV-1 CIRCUIT; and - the common or earthed side of the circuit is connected to the screen of the coaxial cable and to all accessible parts and circuits (SELV, accessible metal parts and LIMITED CURRENT CIRCUITS, if any); and - the screen of the coaxial cable is intended to be connected to earth in the building installation. 		N/A
W.1	<p>Replace the second and the third sentence in the first paragraph with the following:</p> <p>This distinction between earthed and unearthed (floating) circuit is not the same as between CLASS I EQUIPMENT, CLASS 0I EQUIPMENT and CLASS II EQUIPMENT. Floating circuits can exist in CLASS I EQUIPMENT or CLASS 0I EQUIPMENT and earthed circuits in CLASS II EQUIPMENT.</p>		N/A

IEC 60950-1 ATTACHMENT			
Clause	Requirement + Test	Result - Remark	Verdict

Attachment 7 Deviation of JAPAN

Annex JA	<p>Add a new annex JA with the following contents.</p> <p align="center">Annex JA (normative) Document shredding machines</p> <p>Document shredding machines shall also comply with the requirements of this annex except those of STATIONARY EQUIPMENT used by connecting directly to an AC MAINS SUPPLY of three-phase 200V or more.</p> <p>JA.1 Markings and instructions The symbol  (JIS S 0101:2000, 6.2.4) and the following precautions for use shall be marked on readily visible part adjacent to document feed opening. The marking shall be clearly legible, permanent, and easily discernible;</p> <ul style="list-style-type: none"> - that use by an infants/children may cause a hazard of injury etc.; - that a hand can be drawn into the mechanical section for shredding when touching the document-slot; - that clothing can be drawn into the mechanical section for shredding when touching the document-slot; - that hairs can be drawn into the mechanical section for shredding when touching the document-slot; - in case of equipment incorporating a commutator motor, that equipment may catch fire or explode by spraying of flammable gas. <p>JA.2 Inadvertent reactivation Any safety interlock that can be operated by means of the test finger, Figure JA.1, is considered to be likely to cause inadvertent reactivation of the hazard.</p> <p>Compliance is checked by inspection and, where necessary, by a test with the test finger, Figure JA.1</p> <p>JA.3 Disconnection from the mains supply Document shredding machines shall incorporate an isolating switch complying with sub-clause 3.4.2 as the device disconnecting the power of hazardous moving parts. For this switch, two-position (single-use) switch or multi-position (multifunction) switch (e.g., slide switch) may be used.</p>		N/A
----------	---	--	-----

IEC 60950-1 ATTACHMENT			
Clause	Requirement + Test	Result - Remark	Verdict

Attachment 7 Deviation of JAPAN

Annex JA	<p>If two-position switch, the positions for “ON” and “OFF” shall be indicated in accordance with sub-clause 1.7.8. If multi-position switch, the position for “OFF” shall be indicated in accordance with sub-clause 1.7.8 and other positions shall be indicated with proper terms or symbols.</p> <p>Compliance is checked by inspection</p> <p>JA.4 Protection against hazardous moving parts Any warning shall not be used instead of the structure for preventing access to hazardous moving parts. Document shredding machines shall comply with the following requirements.</p> <p>Insert the test finger, Figure JA.1, into all openings in MECHANICAL ENCLOSURES without applying appreciable force. It shall not be possible to touch hazardous moving parts with the test finger. This consideration applies to all sides of MECHANICAL ENCLOSURES when the equipment is mounted as intended. Before testing with the test finger, remove the parts detachable without a tool.</p> <p>Insert the wedge-probe, Figure JA.2, into the document-slot. And, against all directions of openings, if straight-cutting type, a force of 45 N shall apply to the probe, and 90 N if cross-cutting type. In this case, the weight of the probe is to be factored into the overall applied force. Before testing with the wedge-probe, remove the parts detachable without a tool. It shall not be possible to touch any hazardous moving parts, including the shredding roller or the mechanical section for shedding, with the probe.</p>		N/A
----------	--	--	-----

IEC 60950-1 ATTACHMENT			
Clause	Requirement + Test	Result - Remark	Verdict

Attachment 7 Deviation of JAPAN

<p>Annex JA</p>	<p style="text-align: center;">Dimensions in millimeters</p> <p style="text-align: center;">25 Radius</p>	<p>P</p>
-----------------	---	----------

Figure JA.1 Test finger

IEC 60950-1 ATTACHMENT			
Clause	Requirement + Test	Result - Remark	Verdict

Attachment 7 Deviation of JAPAN

Annex JA	<p>The drawing shows a wedge-shaped probe with a total length of 300 mm and a width of 50 mm. The thickness at the tip is 2 mm. Key dimensions include a 12 mm section at the tip, a 30 mm section, a 60 mm section, and a 100 mm section. A circular detail shows a 2 mm thickness. A side view shows a 33 mm wide section with a 30 mm diameter hole and a 27 mm diameter hole. A 20 mm section is shown at the end. A note indicates the probe is rounded to allow rotation about a hinge pin (screw) in one direction. Another note refers to thickness dimensions.</p> <p>Details of the tip of wedge</p> <table border="1"> <thead> <tr> <th>Distance from the tip (mm)</th> <th>Thickness of probe (mm)</th> </tr> </thead> <tbody> <tr> <td>0</td> <td>2</td> </tr> <tr> <td>12</td> <td>4</td> </tr> <tr> <td>180</td> <td>24</td> </tr> </tbody> </table> <p>NOTE 1 The thickness of the probe varies linearly, with slope changes at the respective points shown in the table. NOTE2 The allowable dimensional tolerance of the probe is +/- 0.127 mm.</p> <p>Figure JA.2 Wedge-probe</p>	Distance from the tip (mm)	Thickness of probe (mm)	0	2	12	4	180	24	P
Distance from the tip (mm)	Thickness of probe (mm)									
0	2									
12	4									
180	24									

Attachment 8 REGULATORY REQUIREMENTS FOR SINGAPORE

No	Items	Requirements	Result - Remark	Verdict
<p>The following is the national differences in accordance with safety authority website www.spring.gov.sg/safety, ref. Singapore Consumer Protection (Safety Requirements) – Information Booklet – Chapter 7.</p>				
<p>7 SAFETY AUTHORITY'S REQUIREMENTS</p> <p>The Safety Authority monitors the safety of the controlled goods sold in Singapore by investigating all complaints, incidents and accidents reported to the authority. Experiences gained are translated into the Safety Authority's Requirements. These requirements are to be fulfilled in addition to the applicable safety standards.</p>				
No	Items	Requirements	Result - Remark	Verdict
Applicable to all products				
1	Test certificate / Test report	Test certificate / Test report more than three (3) years old shall be rejected.		P
Applicable to all electrical products				
2	All appliances	All appliances must be tested to 230 VAC.		P
3	Voltage selector (voltage mismatch test)	Appliance fitted with voltage selector shall be tested as follows: Connect appliance to 230 VAC mains with voltage selector switch to settings not suitable for operation at 230 VAC.		N/A
4	Tropical condition test	All appliances (with tropical test requirements in applicable Standards) shall comply with the tropical condition test as stated in the relevant IEC Standards.		P
5	Class I appliances (3-pin mains plug)	All Class I appliances must be fitted with 3-pin mains plugs complied with SS 145/SS 472 that are registered with the Safety Authority.		N/A
6	Class II appliances (mains plug)	a) All Class II appliances must be fitted with 2-pin mains plug (Appendix T) complied with EN 50075. b) Class II appliances that are fitted with 3-pin mains plugs must use plugs that are complied with SS 145 and registered with the Safety Authority.		P
7	Appliances rated ≥ 3 kW or connected to fixed wiring	Electric appliance ≥ 3 kW must be connected to fixed wiring. All connection to fixed wiring must be in accordance with Code of Practice CP5.		N/A

Attachment 8 REGULATORY REQUIREMENTS FOR SINGAPORE

No	Items	Requirements	Result - Remark	Verdict
8	Detachable power cord set (consists of mains plug, mains cord and appliance connector)	Detachable power cord set must be listed in the test report critical component list.		N/A
9	Circuit diagrams	Circuit diagrams must be indicated with component's values for products tested to IEC 60065 and IEC 60950.		P
10	Circuit diagrams of electronic modules in electrical appliances	Circuit diagrams of the electronic modules in the electrical appliances must be provided.		P
11	Controlled goods likely to be treated as toy by children	Controlled goods, having an enclosure, which is shaped and decorated so that it is likely to be treated as a toy by children, shall not be accepted for certification and registration.		N/A
Applicable to electric airpot				
12	Reboil Switch	No part of the reboil switch is allowed to protrude into the water pot, even if it is located above the maximum water level mark.		N/A
Applicable to AC adaptor				
13	3-pin AC adaptor (Appendix V)	Test report showing that the 3-pin complied with sub-clauses 12.1 & 12.3 of SS 246 must be submitted.		N/A
14	2-pin AC adaptor (Appendix V)	The 2-pin (Appendix T) shall comply with EN 50075.	See annex 5 for details	P
15	Detachable power supply cord set not supplied by Registered Supplier	Registered Supplier who is not supplying the detachable power supply cord set together with the AC Adaptor must provide written instruction to its customer on the type of approved detachable power cord set to use.		N/A
Applicable to computer products				
16	CD/DVD ROM (used in personal computer)	Test certificate showing that CD/DVD ROM has complied with IEC 825 must be provided.		N/A
17	Modem Card (used in personal computer)	Modem card incorporated in the personal computer must be tested at set level (sub-clauses 5.1 & 6 of IEC 60950) or at component level.		N/A

Attachment 8 REGULATORY REQUIREMENTS FOR SINGAPORE

No	Items	Requirements	Result - Remark	Verdict
Applicable to ceiling fan and cycle fan				
18	Ceiling fan and cycle fan	a) These appliances must be tested to sub-clauses 5.7 and 5.8 of SS 360: 1992. b) Installation instruction must mention the 3 expansion bolts for fastening the main suspension, safety cord, expansion bolt with hook for fastening safety cord and mounting plate. (Appendix Q) c) Drawing (Appendix P) to show that the wires within the motor shaft are not stressed must be provided.		N/A
Applicable to portable/wall socket-outlet and portable cable reel				
19	Portable/wall socket-outlet and portable cable reel	a) If residual current device (RCD) is incorporated, its tripping current must be less than 30mA and operating time must be less than 0.1 second and testing to sub-clauses 9.9.2.1, 9.9.2.2, 9.9.2.3 and 9.16 of SS 97: Part 1: 2000 are required. b) The shutters screening the current-carrying socket contacts shall not be opened by the insertion of any corresponding SINGLE pin of the plug into any current-carrying socket aperture.		N/A
Applicable to roaster				
20	Roaster	A metal ring (Appendix U) must be provided to prevent the roaster from falling off in case the glass bowl shattered.		N/A
Applicable to Residual Current Circuit Breaker (RCCB)				
21	RCCB	Registration of RCCB is limited to 30 mA sensitivity and the operating time must be less than 0.1 second. Electronic RCCB will not be accepted for registration.		N/A
Applicable to electric instantaneous and storage water heater				
22	Instantaneous electric water heater and mains pressure electric storage water heater	Heating elements used must not be of the "bare-element" type.		N/A
23	Water heater incorporated with residual current device(RCD)	Testing to sub-clauses 9.9.2.1, 9.9.2.2, 9.9.2.3 and 9.16 of SS 97: Part 1: 2000 are required.		N/A

Attachment 8 REGULATORY REQUIREMENTS FOR SINGAPORE

No	Items	Requirements	Result - Remark	Verdict
Applicable to multiway adaptor				
24	Multiway adaptor with 3-pin socket-outlets or combination of 3-pin and 2-pin socket-outlets	<p>a) The socket contacts of the adaptor shall only accept 13A 3-pin mains plug complying with SS 145 and/or 2.5A 2-pin mains plug complying with EN 50075.</p> <p>b) The shutters screening the current-carrying socket contacts shall not be opened by the insertion of any corresponding SINGLE pin of the plug into any current-carrying socket aperture.</p> <p>c) A barrier or other acceptable means shall be provided on the engagement surface of the 2.5A 2-pin socket-outlet of the adaptor to PREVENT entry of any types of 2-pin mains plugs except those complying with EN 50075. (note: shutters cannot be regarded as barriers)</p> <p>d) Adaptor incorporates with switch would require additional test to sub-clauses 13.11, 17.1.3 and 18.1.3 of SS 145: Part 2: 1997.</p>		N/A
Applicable to plasma/LCD display monitor				
25	Plasma/LCD display monitor with TV tuner	Plasma/LCD display monitor tested to IEC 60950 would require additional test to clauses 9 (related to antenna only), 10.1, 10.2, 10.3 and 12.5 of IEC 60065.		N/A

*****End of Attachment 8*****

IEC 60950_1A ATTACHMENT			
Clause	Requirement + Test	Result - Remark	Verdict



Attachment 9 Deviation of China

<p>ATTACHMENT TO TEST REPORT IEC 60950-1 CHINA NATIONAL DIFFERENCES Information technology equipment Safety – Part 1: General requirements</p>
<p>Differences according to.....: GB 4943.1--2011</p>
<p>Attachment Form No......: CN_ND_IEC60950_1A</p>
<p>Attachment Originator: CQC</p>
<p>Master Attachment.....: Date 2012-10</p>
<p>Copyright © 2012 IEC System for Conformity Testing and Certification of Electrical Equipment (IECEE), Geneva, Switzerland. All rights reserved.</p>

	China National Differences	
1.5. 2	Add a note behind the first dashed paragraph. Note: A component used shall comply with related requirements corresponding altitude of 5000m.	N/A
1.7	Add a paragraph before the last paragraph: The required marking and instruction should be given in normative Chinese unless otherwise specified.	P
1.7.1	Amend dashed paragraph at the fifth paragraph : The RATED VOLTAGE should be 220V (single phase) or 380V (three-phases) for single rated voltage, for RATED VOLTAGE RANGE, it should cover 220V or 380V (three-phases), for multiple RATED VOLTAGES, one of them should be 220V or 380V (three-phases) and set on 220V or 380V (three-phases) when manufactured. And the RATED FREQUENCY or RATED FREQUENCY RANGE should be 50Hz or include 50Hz.	P

IEC 60950_1A ATTACHMENT			
Clause	Requirement + Test	Result - Remark	Verdict

Attachment 9 Deviation of China

1.7.2.1	<p>Add requirements of warning for equipment intended to be used at altitude not exceeding 2000m or at non-tropical climate regions:</p> <p>For equipment intended to be used at altitude not exceeding 2000m, a warning label containing the following or a similar appropriate wording, or a symbol as in annex DD shall fixed to the equipment at readily visible place.</p> <p>"Only used at altitude not exceeding 2000m."</p>  <p>For equipment intended to be used in not-tropical climate regions, a warning label containing the following or a similar appropriate wording, or a symbol as in annex DD shall fixed to the equipment at readily visible place.</p> <p>"Only used in not-tropical climate regions."</p>  <p>If only the symbol used, the explanation of the symbol shall be contained in the instruction manual.</p> <p>The above statements shall be given in a language acceptable to the regions where the apparatus is intended to be used.</p>		N/A
2.7.1	<p>Amended the first paragraph as:</p> <p>Protection in PRIMARY CIRCUITS against overcurrent short-circuits and earth faults shall be provided as an integral part of the equipment except special provisions. And the protective device shall meet the requirement of Clause 5.3.</p> <p>Delete note of Clause 2.7.1.</p>		P

IEC 60950_1A ATTACHMENT			
Clause	Requirement + Test	Result - Remark	Verdict

Attachment 9 Deviation of China

2.9.2	<p>First section of Clause 2.9.2 amended as two sections:</p> <p>Where required by 2.9.1, 2.10.8.3, 2.10.10 or 2.10.11, humidity conditioning is conducted for 120 h in a cabinet or room containing air with ambient temperature $40\pm 2^{\circ}\text{C}$ and a relative humidity of $(93\pm 3)\%$. During this conditioning the component or subassembly is not energized.</p> <p>For equipment not to be operated at tropical climatic conditions, Where required by 2.9.1, 2.10.8.3, 2.10.10 or 2.10.11, humidity conditioning is conducted for 48 h in a cabinet or room containing air with a relative humidity of $(93\pm 3)\%$. The temperature of the air, at all places where samples can be located, is maintained within 2°C of any convenient value between 20°C and 30°C such that condensation does not occur.</p> <p>Due to pretreatment of equipment operated at high altitude area is humidity conditioning withstand hot shock, specific requirements are to be considered.</p> <p>Add note: For equipment to be operated at 2000 m - 5000m above sea level, assessment and requirement of humidity conditioning for Insulation material properties are considered.</p>		P
2.10.3.1	<p>Amend the third paragraph of Clause 2.10.3.1 to be:</p> <p>These requirements apply for equipment to be operated up to 2000 m above sea level. For equipment to be operated at more than 2000 m above sea level and up to 5000m above sea level, the minimum CLEARANCE shall be multiplied by the factor 1.48 corresponding altitude of 5000m given in Table A.2 of IEC 60664-1. For equipment to be operated at more than 5000 m above sea level, the minimum CLEARANCE shall be multiplied by the factor given in Table A.2 of IEC 60664-1. Linear interpolation is permitted between the nearest two points in Table A.2. The calculated minimum CLEARANCE using this multiplication factor shall be rounded up to the next higher 0,1 mm increment.</p>		P
2.10.3.3& 2.10.3.4	<p>Add "(applicable for altitude up to 2000m)" in header of Table 2K、 2L and 2M.</p>		P



IEC 60950_1A ATTACHMENT			
Clause	Requirement + Test	Result - Remark	Verdict

Attachment 9 Deviation of China

2.10.3.4	Add a new section above Table 2K and in Clause 2.10.3.4: Minimum CLEARANCES determined by above rules apply for equipment to be operated up to 2000m above sea level. For equipment operated at 2000 m - 5000m above sea level, the minimum CLEARANCE shall be multiplied by the factor 1.48 corresponding altitude of 5000m given in Table A.2 of GB/T16935.1 (IEC 60664-1) . For equipment to be operated at more than 5000 m above sea level, the minimum CLEARANCE shall be multiplied by the factor given in Table A.2 of GB/T16935.1.		P
3.2.1.1	Add a paragraph before the last paragraph: Plugs connected to AC mains supply shall comply with GB 1002 or GB 1003 or GB/T 11918 as applicable.	The plug portion shall be evaluated when submitted for national approval.	N/A
4.2.8	Clause 4.2.8 cathode ray tubes quoted Clause 18 of GB8898-2011. Delete note of Clause 4.2.8.		N/A
Annex E	Amend last section: For comparison of winding temperatures determined by the resistance method of this annex with the temperature limits of Table 4B, 35 °C shall be added to the calculated temperature rise. Add note: for equipment not to be operated at tropical climatic conditions, 25 °C shall be added to the calculated temperature rise to compare with the temperature of Table 4B.		N/A
Annex G.6	Change the second section of Clause G.6 to be: For equipment to be operated at 2000 m - 5000m above sea level, the minimum CLEARANCE shall be multiplied by the factor 1.48 corresponding altitude of 5000m given in Table A.2 of GB/T16935.1. For equipment to be operated at more than 5000 m above sea level, the minimum CLEARANCE shall be multiplied by the factor given in Table A.2 of IEC 60664-1. Linear interpolation is permitted between the nearest two points in Table A.2. The calculated minimum CLEARANCE using this multiplication factor shall be rounded up to the next higher 0,1 mm increment.		P

IEC 60950_1A ATTACHMENT			
Clause	Requirement + Test	Result - Remark	Verdict

Attachment 9 Deviation of China

Annex DD (normative)	<p>Added annex DD: Instructions for the new safety warning labels.</p> <p>DD.1 Altitude warning label </p> <p>Meaning of the label: Evaluation for apparatus only based on altitude not exceeding 2000m, therefor it's the only operating condition applied for the equipment .There may be some potential safety hazard if the equipment is used at altitude above 2000m.</p> <p>DD.2 Climate warning label </p> <p>Meaning of the label: Evaluation for apparatus only based on temperate climate condition, therefor it's the only operating condition applied for the equipment .There may be some potential safety hazard if the equipment is used in tropical climate region.</p>		N/A
Annex EE (informative)	<p>Added annex EE:</p> <p>Illustration relative to safety explanation in normative Chinese、Tibetan、Mongolian、Zhuang Language and Uighur.</p>		N/A

	Special national conditions		--
1.1.2	<p>GB4943.1-2011 applies to equipment used at altitudes not exceeding 5000m above sea level, primarily in regions with moderate or tropical climates.</p> <p>Revise the third dashed paragraph of 1.1.2 as: ——equipment intended to be used in vehicles, on board ships or aircraft, at altitudes greater than 5000m;</p>		P
1.4.5	<p>Amend the second paragraph by the following: If the equipment is intended for direct connection to an AC mains supply, the tolerances on RATED VOLTAGE shall be taken as +10% and -10%.</p>		P

IEC 60950_1A ATTACHMENT			
Clause	Requirement + Test	Result - Remark	Verdict

Attachment 9 Deviation of China

1.4.12.1	<p>Tma: The maximum ambient temperature permitted by the manufacturer's specification, or 35 °C, whichever is greater.</p> <p>Add note 1: For equipment not to be operated at tropical climatic conditions, Tma is the maximum ambient temperature permitted by the manufacturer's specification, or 25 °C, whichever is greater.</p> <p>Add note 2: For equipment to be operated at 2000m-5000m above sea level, its temperature test conditions and temperature limits are under consideration.</p>		P
----------	---	--	---

*****End of Attachment 9*****