



# CE EMC TEST REPORT

**REPORT NO.:** CP110704D09A

**MODEL NO.:** GT-43008-WWVV-X.X-T2 series

**RECEIVED:** Jul. 4, 2011

**TESTED:** Aug. 5 ~ 11, 2011

**ISSUED:** Oct. 19, 2011

**APPLICANT:** GlobTek, Inc.

**ADDRESS:** 186 Veterans Dr. Northvale, NJ 07647, U.S.A.

**ISSUED BY:** Bureau Veritas Consumer Products Services (H.K.)  
Ltd., Taoyuan Branch

**LAB LOCATION:** No. 47, 14th Ling, Chia Pau Tsuen, Lin Kou Hsiang,  
Taipei Hsien 244, Taiwan

This test report consists of 95 pages in total. It may be duplicated completely for legal use with the approval of the applicant. It should not be reproduced except in full, without the written approval of our laboratory. The client should not use it to claim product certification, approval, or endorsement by TAF or any government agency. The test results in the report only apply to the tested sample. The test results in this report are traceable to the national or international standards.





## Table of Contents

RELEASE CONTROL RECORD.....	5
1 CERTIFICATION.....	6
2 SUMMARY OF TEST RESULTS.....	8
2.1 MEASUREMENT UNCERTAINTY .....	10
3 GENERAL INFORMATION .....	11
3.1 GENERAL DESCRIPTION OF EUT.....	11
3.2 DESCRIPTION OF TEST MODES.....	12
3.3 GENERAL DESCRIPTION OF APPLIED STANDARDS .....	13
3.4 DESCRIPTION OF SUPPORT UNITS.....	14
3.4.1 FOR EMISSION TEST .....	14
3.4.2 FOR HARMONICS, FLICKER & IMMUNITY TEST.....	15
4 EMISSION TEST.....	16
4.1 CONDUCTED EMISSION MEASUREMENT .....	16
4.1.1 LIMITS OF CONDUCTED EMISSION MEASUREMENT.....	16
4.1.2 TEST INSTRUMENTS .....	16
4.1.3 TEST PROCEDURE .....	17
4.1.4 DEVIATION FROM TEST STANDARD .....	17
4.1.5 TEST SETUP .....	17
4.1.6 EUT OPERATING CONDITIONS.....	17
4.1.7 TEST RESULTS (1) .....	18
4.1.8 TEST RESULTS (2) .....	20
4.1.9 TEST RESULTS (3) .....	22
4.1.10 TEST RESULTS (4) .....	24
4.1.11 TEST RESULTS (5) .....	26
4.1.12 TEST RESULTS (6) .....	28
4.1.13 TEST RESULTS (7) .....	30
4.1.14 TEST RESULTS (8) .....	32
4.2 RADIATED EMISSION MEASUREMENT .....	34
4.2.1 LIMITS OF RADIATED EMISSION MEASUREMENT.....	34
4.2.2 TEST INSTRUMENTS .....	35
4.2.3 TEST PROCEDURE .....	36
4.2.4 DEVIATION FROM TEST STANDARD .....	36
4.2.5 TEST SETUP .....	37
4.2.6 EUT OPERATING CONDITIONS.....	37
4.2.7 TEST RESULTS (1) .....	38
4.2.8 TEST RESULTS (2) .....	40
4.2.9 TEST RESULTS (3) .....	42
4.2.10 TEST RESULTS (4) .....	44
4.3 HARMONICS CURRENT MEASUREMENT .....	46
4.3.1 LIMITS OF HARMONICS CURRENT MEASUREMENT.....	46
4.3.2 TEST INSTRUMENTS .....	46



A D T

4.3.3	TEST PROCEDURE .....	47
4.3.4	DEVIATION FROM TEST STANDARD .....	47
4.3.5	TEST SETUP .....	47
4.3.6	EUT OPERATING CONDITIONS .....	47
4.3.7	TEST RESULTS .....	48
4.4	VOLTAGE FLUCTUATION AND FLICKS MEASUREMENT .....	49
4.4.1	LIMITS OF VOLTAGE FLUCTUATION AND FLICKS MEASUREMENT .....	49
4.4.2	TEST INSTRUMENTS .....	49
4.4.3	TEST PROCEDURE .....	49
4.4.4	DEVIATION FROM TEST STANDARD .....	49
4.4.5	TEST SETUP .....	50
4.4.6	EUT OPERATING CONDITIONS .....	50
4.4.7	TEST RESULTS .....	51
5	IMMUNITY TEST .....	52
5.1	GENERAL DESCRIPTION .....	52
5.2	GENERAL PERFORMANCE CRITERIA DESCRIPTION .....	54
5.3	EUT OPERATING CONDITION .....	55
5.4	ELECTROSTATIC DISCHARGE IMMUNITY TEST (ESD) .....	56
5.4.1	TEST SPECIFICATION .....	56
5.4.2	TEST INSTRUMENTS .....	56
5.4.3	TEST PROCEDURE .....	56
5.4.4	DEVIATION FROM TEST STANDARD .....	57
5.4.5	TEST SETUP .....	58
5.4.6	TEST RESULTS .....	59
5.5	RADIATED, RADIO-FREQUENCY, ELECTROMAGNETIC FIELD IMMUNITY TEST (RS) .....	60
5.5.1	TEST SPECIFICATION .....	60
5.5.2	TEST INSTRUMENTS .....	61
5.5.3	TEST PROCEDURE .....	62
5.5.4	DEVIATION FROM TEST STANDARD .....	62
5.5.5	TEST SETUP .....	62
5.5.6	TEST RESULTS .....	63
5.6	RADIO-FREQUENCY ELECTROMAGNETIC FIELD – KEYED CARRIER TEST .....	64
5.6.1	TEST SPECIFICATION .....	64
5.6.2	TEST INSTRUMENTS .....	65
5.6.3	TEST PROCEDURE .....	66
5.6.4	DEVIATION FROM TEST STANDARD .....	66
5.6.5	TEST SETUP .....	66
5.6.6	TEST RESULTS .....	67
5.7	ELECTRICAL FAST TRANSIENT/BURST IMMUNITY TEST (EFT) .....	68
5.7.1	TEST SPECIFICATION .....	68
5.7.2	TEST INSTRUMENTS .....	68
5.7.3	TEST PROCEDURE .....	68
5.7.4	DEVIATION FROM TEST STANDARD .....	68
5.7.5	TEST SETUP .....	69
5.7.6	TEST RESULTS .....	70



A D T

5.8	SURGE IMMUNITY TEST .....	71
5.8.1	TEST SPECIFICATION .....	71
5.8.2	TEST INSTRUMENTS .....	71
5.8.3	TEST PROCEDURE .....	72
5.8.4	DEVIATION FROM TEST STANDARD .....	72
5.8.5	TEST SETUP .....	72
5.8.6	TEST RESULTS.....	73
5.9	IMMUNITY TO CONDUCTED DISTURBANCES INDUCED BY RF FIELDS (CS).....	74
5.9.1	TEST SPECIFICATION .....	74
5.9.2	TEST INSTRUMENTS .....	75
5.9.3	TEST PROCEDURE .....	76
5.9.4	DEVIATION FROM TEST STANDARD .....	76
5.9.5	TEST SETUP .....	77
5.9.6	TEST RESULTS.....	78
5.10	POWER FREQUENCY MAGNETIC FIELD IMMUNITY TEST.....	79
5.10.1	TEST SPECIFICATION .....	79
5.10.2	TEST INSTRUMENTS .....	79
5.10.3	TEST PROCEDURE .....	79
5.10.4	DEVIATION FROM TEST STANDARD .....	79
5.10.5	TEST SETUP .....	80
5.10.6	TEST RESULTS.....	81
5.11	VOLTAGE DIP/SHORT INTERRUPTIONS/VOLTAGE VARIATIONS (DIP) IMMUNITY TEST .....	82
5.11.1	TEST SPECIFICATION .....	82
5.11.2	TEST INSTRUMENTS .....	82
5.11.3	TEST PROCEDURE .....	82
5.11.4	DEVIATION FROM TEST STANDARD .....	82
5.11.5	TEST SETUP .....	83
5.11.6	TEST RESULTS – FOR EN 61204-3 .....	84
5.11.7	TEST RESULTS – FOR EN 55024 .....	85
6	PHOTOGRAPHS OF THE TEST CONFIGURATION.....	86
7	APPENDIX - INFORMATION ON THE TESTING LABORATORIES.....	95



A D T

## RELEASE CONTROL RECORD

ISSUE NO.	REASON FOR CHANGE	DATE ISSUED
CP110704D09A	Original release	Oct. 19, 2011



# 1 CERTIFICATION

**PRODUCT:** Switching Power Supply

**BRAND NAME:** GlobTek

**MODEL NO.:** GT-43008-WWVV-X.X-T2 series

(WW is the rated output wattage designation, with a maximum value of "50.4";  
VV is the standard rated output voltage designation, with a maximum value of "24"  
-X.X designates the optional deviation, X.X should be VV minus the rated voltage,  
and it can be blank)

**TEST ITEM:** ENGINEERING SAMPLE

**APPLICANT:** GlobTek, Inc.

**TESTED:** Aug. 5 ~ 11, 2011

**STANDARDS:** **EN 61204-3: 2000, Class B**

***Emission:***

CISPR 22: 1997, Class B

IEC 61000-3-2: 2005

+A1: 2008+A2: 2009

IEC 61000-3-3: 2008

***Immunity:***

IEC 61000-4-2: 2008 ED.2.0

IEC 61000-4-3: 2006

+A1: 2007+A2: 2010 ED.3.0

IEC 61000-4-4: 2004+A1:2010 ED.2.0

IEC 61000-4-5: 2005 ED.2.0

IEC 61000-4-6: 2008 ED.3.0

IEC 61000-4-11: 2004 ED.2.0

**EN 55022: 2006+A1: 2007, Class B**

**CISPR 22: 2008, Class B**

**AS/NZS CISPR 22: 2009, Class B**

**EN 61000-3-2:2006+A1: 2009**

**+A2: 2009**

**EN 61000-3-3: 2008**

**EN 55024: 1998+A1: 2001+A2: 2003**

IEC 61000-4-2: 2008 ED.2.0

IEC 61000-4-3: 2006+A1: 2007

+A2: 2010 ED.3.0

IEC 61000-4-4: 2004+A1:2010 ED.2.0

IEC 61000-4-5: 2005 ED.2.0

IEC 61000-4-6: 2008 ED.3.0

IEC 61000-4-8: 2009 ED.2.0

IEC 61000-4-11: 2004 ED.2.0

The above equipment have been tested by **Bureau Veritas Consumer Products Services (H.K.) Ltd., Taoyuan Branch**, and found compliance with the requirement of the above standards.

Approval signature – on next page



**CERTIFICATION – Continued**

The test record, data evaluation & Equipment Under Test (EUT) configurations represented herein are true and accurate accounts of the measurements of the sample's EMC characteristics under the conditions specified in this report.

PREPARED BY : Albee Chu , DATE: Oct. 19, 2011  
( Albee Chu / Specialist )

APPROVED BY : Kenny Meng , DATE: Oct. 19, 2011  
( Kenny Meng / Assistant Manager )

## 2 SUMMARY OF TEST RESULTS

The EUT has been tested according to the following specifications:

EMISSION			
Standard	Test Type	Result	Remarks
CISPR 22: 1997, Class B  EN 55022: 2006 +A1: 2007, Class B	Conducted Test	PASS	Meets Class B Limit Minimum passing margin is -1.20 dB at 0.197 MHz
CISPR 22: 2008, Class B  AS/NZS CISPR 22: 2009, Class B	Radiated Test (30MHz to 1GHz)	PASS	Meets Class B Limit Minimum passing margin is -2.25 dB at 76.54 MHz
IEC 61000-3-2: 2005 +A1: 2008+A2: 2009, Class D  EN 61000-3-2: 2006 +A1: 2009+A2: 2009, Class D	Harmonic current emissions	PASS	The power consumption of EUT is less than 75W and no limits apply
IEC 61000-3-3: 2008 EN 61000-3-3: 2008	Voltage fluctuations & flicker	PASS	Meets the requirements.

**Note:** The EUT highest frequency generated below 108MHz and therefore the test frequency range was performed for 30MHz to 1GHz for radiated emission test.





<b>IMMUNITY (EN 61204-3: 2000) &amp; (EN 55024: 1998+A1: 2001+A2: 2003)</b>			
<b>Standard</b>	<b>Test Type</b>	<b>Result</b>	<b>Remarks</b>
IEC 61000-4-2: 2008 ED.2.0	Electrostatic discharge immunity test	PASS	Meets the requirements of Performance Criterion A
IEC 61000-4-3: 2006 +A1: 2007+A2: 2010 ED.3.0	Radiated, radio-frequency, electromagnetic field immunity test	PASS	Meets the requirements of Performance Criterion A
IEC 61000-4-4: 2004 ED.2.0	Electrical fast transient / burst immunity test.	PASS	Meets the requirements of Performance Criterion A
IEC 61000-4-5: 2005 ED.2.0	Surge immunity test	PASS	Meets the requirements of Performance Criterion A
IEC 61000-4-6: 2008 ED.3.0	Immunity to conducted disturbances, induced by radio-frequency fields	PASS	Meets the requirements of Performance Criterion A
IEC 61000-4-8: 2009 ED.2.0 <i>(for EN 55024 only)</i>	Power frequency magnetic field immunity test.	PASS	Meets the requirements of Performance Criterion A
IEC 61000-4-11: 2004 ED.2.0 <i>(for EN 61204-3)</i>	Voltage dips, short interruptions and voltage variations immunity tests	PASS	Meets the requirements of <b>Voltage Dips:</b> i).30% reduction – Performance Criterion A ii).60% reduction – Performance Criterion B <b>Voltage Interruptions:</b> i).>95% reduction – Performance Criterion B
IEC 61000-4-11: 2004 ED.2.0 <i>(for EN 55024)</i>	Voltage dips, short interruptions and voltage variations immunity tests	PASS	Meets the requirements of <b>Voltage Dips:</b> i). >95% reduction – Performance Criterion A ii). 30% reduction – Performance Criterion A <b>Voltage Interruptions:</b> i). >95% reduction – Performance Criterion B

## 2.1 MEASUREMENT UNCERTAINTY

Where relevant, the following measurement uncertainty levels have been estimated for tests performed on the EUT as specified in CISPR 16-4-2:

This uncertainty represents an expanded uncertainty expressed at approximately the 95% confidence level using a coverage factor of  $k=2$ .

MEASUREMENT	UNCERTAINTY
Conducted emissions	3.46 dB
Radiated emissions	3.78 dB

### 3 GENERAL INFORMATION

#### 3.1 GENERAL DESCRIPTION OF EUT

<b>PRODUCT</b>	Switching Power Supply
<b>MODEL NO.</b>	GT-43008-WWVV-X.X-T2 series
<b>POWER SUPPLY</b>	Switching Rating refer to below Power Coed: Non-shielded DC cable (1.5m)
<b>DATA CABLE SUPPLIED</b>	N/A

**NOTE:**

- The EUT is a Switching Power Supply (AC 2-pin).
- The "WW", "VV", "-X.X" in the model no.: GT-43008-WWVV-X.X-T2 series could be defined as the following:
  - ◆ WW is the rated output wattage designation, with a maximum value of "50.4"
  - ◆ VV is the standard rated output voltage designation, with a maximum value of "24";
  - ◆ -X.X designates the optional deviation, X.X should be VV minus the rated voltage, and it can be blank.
- The EUT has following models which are identical to each other except for their output rating and transformer difference, as follows:

Model No	DC Output		Resistor		Transformer
	Voltage (V)	Current (A)	R21 (ohm)	R23 (ohm)	
GT-43008-3306-1.0-T2	5	6.5	3.57K±1%	3.32K±1%	XF00732
GT-43008-3606-T2	5.95	6	5.6K±1%	3.9K±1%	
GT-43008-4509-T2	9	4	8.87K±1%	3.32K±1%	XF00751
GT-43008-3609-T2	9	5	8.87K±1%	3.32K±1%	
GT-43008-5015-3.0-T2	12	4.2	18.2K±1%	4.64K±1%	XF00623
GT-43008-5015-T2	15	3.34	20.0K±1%	3.0K±1%	
GT-43008-5024-5.0-T2	19	2.64	20.0K±1%	3.0K±1%	XF00624
GT-43008-5024-T2	24	2.08	38.3K±1%	4.42K±1%	

**AC I/P:** 100-240V, 50-60Hz, 1.2A

- For a more detailed features description, please refer to the manufacturer's specifications or the User's Manual.

### 3.2 DESCRIPTION OF TEST MODES

1. The EUT is designed with AC power supply of 100-240V, 50-60Hz. For radiated evaluation, 230V/ 50Hz (for EN 55022), 120V/ 60Hz (for FCC Part 15) had been covered during the pre-test. The worst radiated emission data was founded at **120V/ 60Hz** and recorded in the applied test report.
2. For radiated emission test, all models were pre-tested. The worse radiated emission data were founded at models: **GT-43008-3306-1.0-T2**, **GT-43008-3609-T2**, **GT-43008-5015-3.0-T2**, **GT-43008-5024-T2** and recorded in the applied test report.
3. Per pre-test result, the EUT was tested under the following modes:

Test Item	Test Mode	Description of Test Mode		
		Model No.	Input Power	Test Condition
Conducted Test	Mode 1	GT-43008-3306-1.0-T2	230V/50Hz	Full load
	Mode 2	GT-43008-3606-T2		
	Mode 3	GT-43008-3609-T2		
	Mode 4	GT-43008-4509-T2		
	Mode 5	GT-43008-5015-3.0-T2		
	Mode 6	GT-43008-5015-T2		
	Mode 7	GT-43008-5024-5.0-T2		
	Mode 8	GT-43008-5024-T2		
Radiated Test	Mode 1	GT-43008-3306-1.0-T2	120V/60Hz	Full load
	Mode 2	GT-43008-3609-T2		
	Mode 3	GT-43008-5015-3.0-T2		
	Mode 4	GT-43008-5024-T2		
	The test mode was selected the worse case of each transformer per pre-tested result.			
Harmonic / Flicker / Immunity Tests	Mode 1	GT-43008-3609-T2	230V/50Hz	

### 3.3 GENERAL DESCRIPTION OF APPLIED STANDARDS

The EUT is a Switching Power Supply, which are intended for sale to an end-users or installer. Therefore, according to the specifications of the manufacturers, must comply with the requirements of the following standards:

**EN 61204-3: 2000, Class B**

***Emission:***

CISPR 22: 1997, Class B

IEC 61000-3-2: 2005+A1: 2008+A2: 2009

IEC 61000-3-3: 2008

***Immunity:***

IEC 61000-4-2: 2008 ED.2.0

IEC 61000-4-3: 2006+A1: 2007+A2: 2010

ED.3.0

IEC 61000-4-4: 2004+A1: 2010 ED.2.0

IEC 61000-4-5: 2005 ED.2.0

IEC 61000-4-6: 2008 ED.3.0

IEC 61000-4-11: 2004 ED.2.0

**EN 55022: 2006+A1: 2007, Class B**

**CISPR 22: 2008, Class B**

**AS/NZS CISPR 22: 2009, Class B**

**EN 61000-3-2:2006+A1: 2009+A2: 2009**

**EN 61000-3-3: 2008**

**EN 55024: 1998+A1: 2001+A2: 2003**

IEC 61000-4-2: 2008 ED.2.0

IEC 61000-4-3: 2006+A1: 2007+A2: 2010

ED.3.0

IEC 61000-4-4: 2004+A1: 2010 ED.2.0

IEC 61000-4-5: 2005 ED.2.0

IEC 61000-4-6: 2008 ED.3.0

IEC 61000-4-8: 2009 ED.2.0

IEC 61000-4-11: 2004 ED.2.0

**Notes:** The above IEC basic standards are applied with latest version if customer has no special requirement

### 3.4 DESCRIPTION OF SUPPORT UNITS

The EUT has been tested as an independent unit together with other necessary accessories or support units. The following support units or accessories were used to form a representative test configuration during the tests.

#### 3.4.1 FOR EMISSION TEST

NO.	PRODUCT	BRAND	MODEL NO.	SERIAL NO.	FCC ID
1	DUMMY LOAD	BVADT	L19B	L2-010027	N/A
2	DUMMY LOAD	BVADT	L19B	L2-010028	N/A

**NOTE:** One non-shielded AC 3-Pin power cord (1.8 m) was connected to EUT.

#### TEST CONFIGURATION

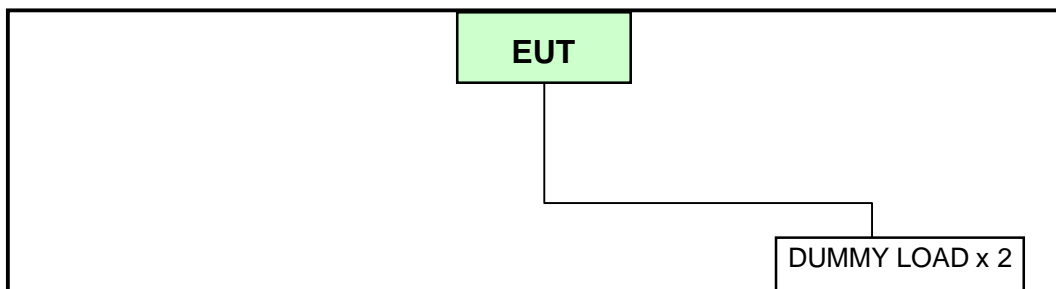

### 3.4.2 FOR HARMONICS, FLICKER & IMMUNITY TEST

NO.	PRODUCT	BRAND	MODEL NO.	SERIAL NO.	FCC ID
1	DUMMY LOAD	BVADT	L19B	L2-010029	N/A
2	Multimeter	YFE	YF-370A	N/A	N/A

**NOTE:** One non-shielded AC 3-Pin power cord (1.8 m) was connected to EUT.

#### TEST CONFIGURATION – for Harmonic & Flicker Test

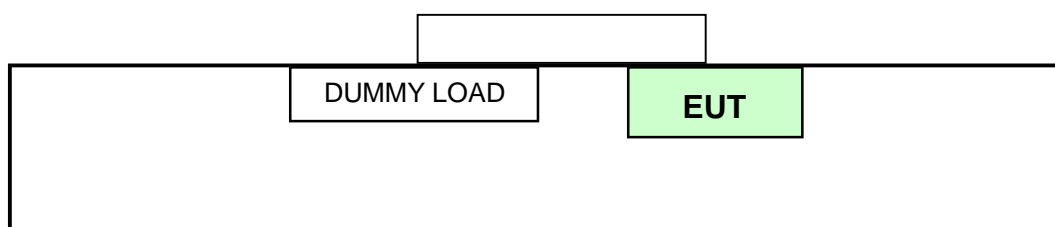

#### TEST CONFIGURATION – for Immunity Test

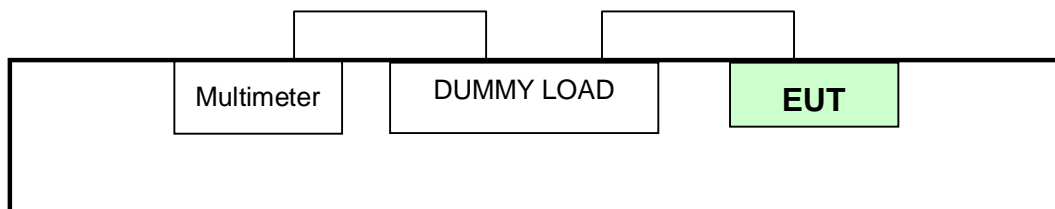

## 4 EMISSION TEST

### 4.1 CONDUCTED EMISSION MEASUREMENT

#### 4.1.1 LIMITS OF CONDUCTED EMISSION MEASUREMENT

TEST STANDARD: EN 55022 / EN 61204-3

FREQUENCY (MHz)	Class A (dBuV)		Class B (dBuV)	
	Quasi-peak	Average	Quasi-peak	Average
0.15 - 0.5	79	66	66 - 56	56 - 46
0.50 - 5.0	73	60	56	46
5.0 - 30.0	73	60	60	50

- NOTE:**
- (1) The lower limit shall apply at the transition frequencies.
  - (2) The limit decreases in line with the logarithm of the frequency in the range of 0.15 to 0.50 MHz.
  - (3) All emanations from a class A/B digital device or system, including any network of conductors and apparatus connected thereto, shall not exceed the level of field strengths specified above.

#### 4.1.2 TEST INSTRUMENTS

DESCRIPTION & MANUFACTURER	MODEL NO.	SERIAL NO.	CALIBRATED DATE	CALIBRATED UNTIL
ROHDE & SCHWARZ Test Receiver	ESCS 30	834115/016	Apr. 07, 2011	Apr. 06, 2012
ROHDE & SCHWARZ Artificial Mains Network (For EUT)	ESH2-Z5	828075/003	Aug. 23, 2010	Aug. 22, 2011
LISN With Adapter (for EUT)	AD10	C03Ada-001	Aug. 23, 2010	Aug. 22, 2011
EMCO L.I.S.N. (For peripherals)	3825/2	9504-2359	Jul. 11, 2011	Jul. 10, 2012
Software	ADT_Cond_V7.3.7	NA	NA	NA
Software	ADT_ISN_V7.3.7	NA	NA	NA
RF cable (JYBAO)	5D-FB	Cable-C03.01	Jan. 08, 2011	Jan. 07, 2012
LYNICS Terminator (For EMCO LISN)	0900510	E1-01-300	Jan. 24, 2011	Jan. 23, 2012
LYNICS Terminator (For EMCO LISN)	0900510	E1-01-301	Jan. 24, 2011	Jan. 23, 2012

- NOTE:**
1. The calibration interval of the above test instruments is 12 months and the calibrations are traceable to NML/ROC and NIST/USA.
  2. The test was performed in Shielded Room No. 3.
  3. The VCCI Site Registration No. C-274.



### 4.1.3 TEST PROCEDURE

- a. The EUT was placed 0.4 meters from the conducting wall of the shielded room with EUT being connected to the power mains through a line impedance stabilization network (LISN). Other support units were connected to the power mains through another LISN. The two LISNs provide 50 Ohm/ 50uH of coupling impedance for the measuring instrument.
- b. Both lines of the power mains connected to the EUT were checked for maximum conducted interference.
- c. The frequency range from 150 kHz to 30 MHz was searched. Emission levels under (Limit -20dB) were not recorded.

### 4.1.4 DEVIATION FROM TEST STANDARD

No deviation

### 4.1.5 TEST SETUP

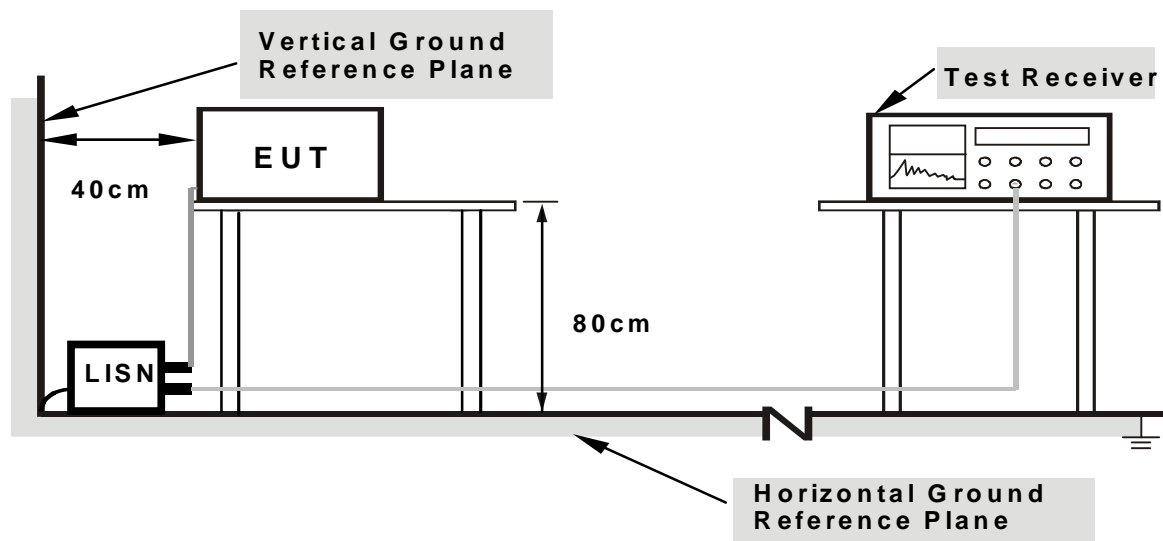

- Note:**
1. Support units were connected to second LISN.
  2. Both of LISNs (AMN) are 80cm from EUT and at least 80cm from other units and other metal planes support units.

For the actual test configuration, please refer to the related item – Photographs of the Test Configuration.

### 4.1.6 EUT OPERATING CONDITIONS

Set the EUT under full resistor load.



A D T

### 4.1.7 TEST RESULTS (1)

<b>TEST MODE</b>	Mode 1	<b>6dB BANDWIDTH</b>	9 kHz
<b>INPUT POWER</b>	230Vac, 50 Hz	<b>PHASE</b>	Line (L)
<b>ENVIRONMENTAL CONDITIONS</b>	26deg. C, 61% RH	<b>TESTED BY:</b> Dalen Dai	

No	Freq. [MHz]	Corr. Factor (dB)	Reading Value		Emission Level		Limit		Margin	
			[dB (uV)]		[dB (uV)]		[dB (uV)]		(dB)	
			Q.P.	AV.	Q.P.	AV.	Q.P.	AV.	Q.P.	AV.
1	0.150	0.24	38.23	14.17	38.47	14.41	66.00	56.00	-27.53	-41.59
2	0.193	0.27	49.08	32.45	49.35	32.72	63.91	53.91	-14.56	-21.19
3	0.271	0.28	39.48	24.89	39.76	25.17	61.08	51.08	-21.32	-25.91
4	1.207	0.45	27.03	12.36	27.48	12.81	56.00	46.00	-28.52	-33.19
5	2.172	0.55	28.95	16.85	29.50	17.40	56.00	46.00	-26.50	-28.60
6	3.758	0.52	30.70	20.99	31.22	21.51	56.00	46.00	-24.78	-24.49

- REMARKS:**
1. Q.P. and AV. are abbreviations of quasi-peak and average individually.
  2. "-": The Quasi-peak reading value also meets average limit and measurement with the average detector is unnecessary.
  3. The emission levels of other frequencies were very low against the limit.
  4. Margin value = Emission level - Limit value
  5. Correction factor = Insertion loss + Cable loss
  6. Emission Level = Correction Factor + Reading Value.

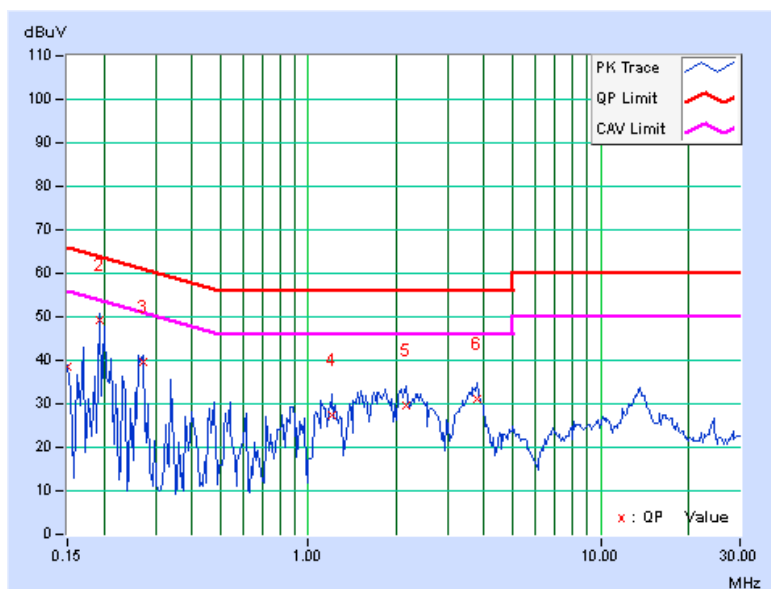



A D T

<b>TEST MODE</b>	Mode 1	<b>6dB BANDWIDTH</b>	9 kHz
<b>INPUT POWER</b>	230Vac, 50 Hz	<b>PHASE</b>	Neutral (N)
<b>ENVIRONMENTAL CONDITIONS</b>	26deg. C, 61% RH	<b>TESTED BY:</b> Dalen Dai	

No	Freq. [MHz]	Corr. Factor (dB)	Reading Value		Emission Level		Limit		Margin	
			[dB (uV)]		[dB (uV)]		[dB (uV)]		(dB)	
	Q.P.	AV.	Q.P.	AV.	Q.P.	AV.	Q.P.	AV.	Q.P.	AV.
1	0.150	0.27	39.54	15.46	39.81	15.73	66.00	56.00	-26.19	-40.27
2	0.201	0.30	50.83	39.62	51.13	39.92	63.58	53.58	-12.45	-13.66
3	0.275	0.31	39.86	24.99	40.17	25.30	60.97	50.97	-20.79	-25.66
4	0.783	0.42	28.31	15.81	28.73	16.23	56.00	46.00	-27.27	-29.77
5	1.523	0.52	27.80	15.56	28.32	16.08	56.00	46.00	-27.68	-29.92
6	3.793	0.62	32.48	19.46	33.10	20.08	56.00	46.00	-22.90	-25.92

- REMARKS:**
1. Q.P. and AV. are abbreviations of quasi-peak and average individually.
  2. "-": The Quasi-peak reading value also meets average limit and measurement with the average detector is unnecessary.
  3. The emission levels of other frequencies were very low against the limit.
  4. Margin value = Emission level - Limit value
  5. Correction factor = Insertion loss + Cable loss
  6. Emission Level = Correction Factor + Reading Value.

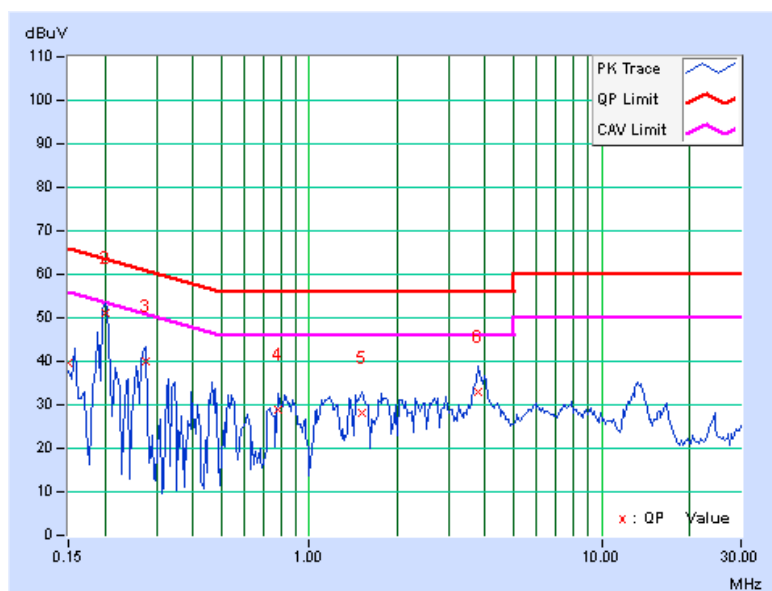

### 4.1.8 TEST RESULTS (2)

<b>TEST MODE</b>	Mode 2	<b>6dB BANDWIDTH</b>	9 kHz
<b>INPUT POWER</b>	230Vac, 50 Hz	<b>PHASE</b>	Line (L)
<b>ENVIRONMENTAL CONDITIONS</b>	26deg. C, 61% RH	<b>TESTED BY:</b> Dalen Dai	

No	Freq. [MHz]	Corr. Factor (dB)	Reading Value		Emission Level		Limit		Margin	
			[dB (uV)]		[dB (uV)]		[dB (uV)]		(dB)	
			Q.P.	AV.	Q.P.	AV.	Q.P.	AV.	Q.P.	AV.
1	0.209	0.27	47.71	30.50	47.98	30.77	63.26	53.26	-15.28	-22.49
2	0.263	0.28	41.08	26.31	41.36	26.59	61.33	51.33	-19.96	-24.73
3	0.392	0.31	35.22	22.43	35.53	22.74	58.02	48.02	-22.49	-25.28
4	1.543	0.50	28.91	13.56	29.41	14.06	56.00	46.00	-26.59	-31.94
5	3.879	0.52	31.70	20.14	32.22	20.66	56.00	46.00	-23.78	-25.34
6	13.027	0.66	28.73	21.07	29.39	21.73	60.00	50.00	-30.61	-28.27

- REMARKS:**
1. Q.P. and AV. are abbreviations of quasi-peak and average individually.
  2. "-": The Quasi-peak reading value also meets average limit and measurement with the average detector is unnecessary.
  3. The emission levels of other frequencies were very low against the limit.
  4. Margin value = Emission level - Limit value
  5. Correction factor = Insertion loss + Cable loss
  6. Emission Level = Correction Factor + Reading Value.

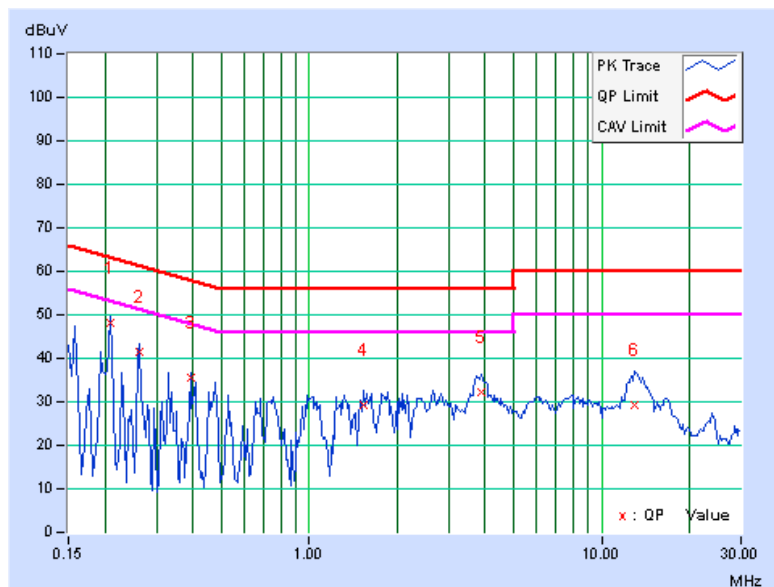



A D T

<b>TEST MODE</b>	Mode 2	<b>6dB BANDWIDTH</b>	9 kHz
<b>INPUT POWER</b>	230Vac, 50 Hz	<b>PHASE</b>	Neutral (N)
<b>ENVIRONMENTAL CONDITIONS</b>	26deg. C, 61% RH	<b>TESTED BY:</b> Dalen Dai	

No	Freq. [MHz]	Corr. Factor (dB)	Reading Value		Emission Level		Limit		Margin	
			[dB (uV)]		[dB (uV)]		[dB (uV)]		(dB)	
	Q.P.	AV.	Q.P.	AV.	Q.P.	AV.	Q.P.	AV.	Q.P.	AV.
1	0.205	0.30	50.42	36.37	50.72	36.67	63.42	53.42	-12.70	-16.75
2	0.275	0.31	38.61	20.19	38.92	20.50	60.97	50.97	-22.04	-30.46
3	0.404	0.34	33.04	18.31	33.38	18.65	57.77	47.77	-24.39	-29.12
4	2.168	0.58	29.72	17.22	30.30	17.80	56.00	46.00	-25.70	-28.20
5	3.684	0.62	32.30	21.53	32.92	22.15	56.00	46.00	-23.08	-23.85
6	13.074	0.76	26.79	19.06	27.55	19.82	60.00	50.00	-32.45	-30.18

- REMARKS:**
1. Q.P. and AV. are abbreviations of quasi-peak and average individually.
  2. "-": The Quasi-peak reading value also meets average limit and measurement with the average detector is unnecessary.
  3. The emission levels of other frequencies were very low against the limit.
  4. Margin value = Emission level - Limit value
  5. Correction factor = Insertion loss + Cable loss
  6. Emission Level = Correction Factor + Reading Value.

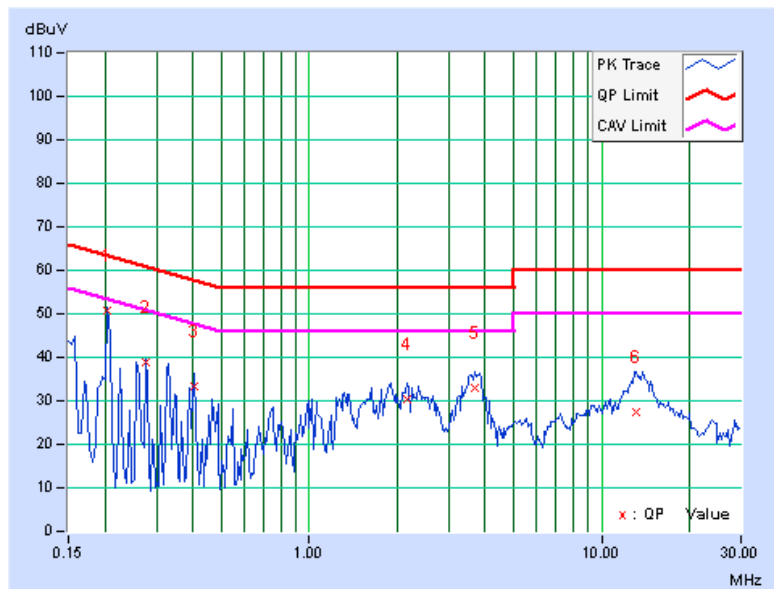



A D T

### 4.1.9 TEST RESULTS (3)

<b>TEST MODE</b>	Mode 3	<b>6dB BANDWIDTH</b>	9 kHz
<b>INPUT POWER</b>	230Vac, 50 Hz	<b>PHASE</b>	Line (L)
<b>ENVIRONMENTAL CONDITIONS</b>	26deg. C, 61% RH	<b>TESTED BY:</b> Dalen Dai	

No	Freq. [MHz]	Corr. Factor (dB)	Reading Value		Emission Level		Limit		Margin	
			[dB (uV)]		[dB (uV)]		[dB (uV)]		(dB)	
			Q.P.	AV.	Q.P.	AV.	Q.P.	AV.	Q.P.	AV.
1	0.197	0.27	55.18	42.10	55.45	42.37	63.74	53.74	-8.29	-11.37
2	0.255	0.28	47.60	30.43	47.88	30.71	61.58	51.58	-13.70	-20.87
3	0.330	0.30	39.37	21.84	39.67	22.14	59.46	49.46	-19.79	-27.32
4	1.609	0.50	29.63	17.54	30.13	18.04	56.00	46.00	-25.87	-27.96
5	3.590	0.53	27.98	14.30	28.51	14.83	56.00	46.00	-27.49	-31.17
6	28.395	0.58	34.99	29.33	35.57	29.91	60.00	50.00	-24.43	-20.09

- REMARKS:**
1. Q.P. and AV. are abbreviations of quasi-peak and average individually.
  2. "-": The Quasi-peak reading value also meets average limit and measurement with the average detector is unnecessary.
  3. The emission levels of other frequencies were very low against the limit.
  4. Margin value = Emission level - Limit value
  5. Correction factor = Insertion loss + Cable loss
  6. Emission Level = Correction Factor + Reading Value.

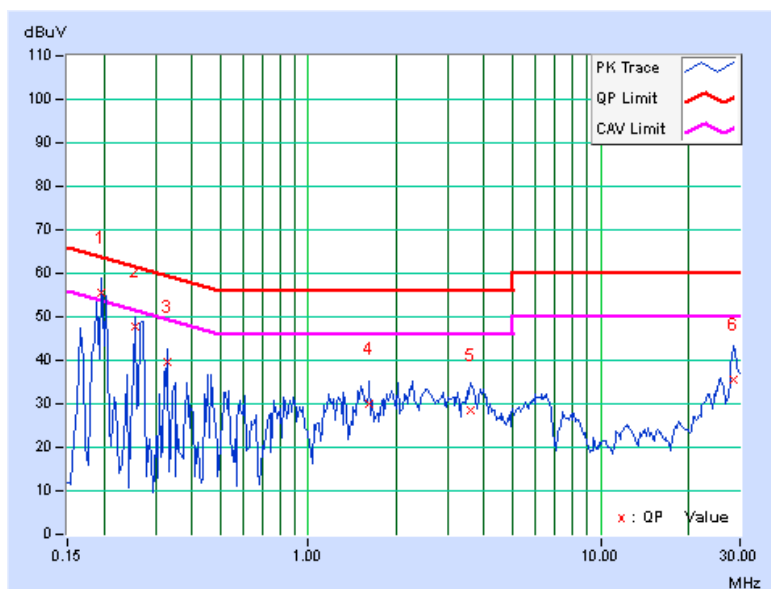



A D T

<b>TEST MODE</b>	Mode 3	<b>6dB BANDWIDTH</b>	9 kHz
<b>INPUT POWER</b>	230Vac, 50 Hz	<b>PHASE</b>	Neutral (N)
<b>ENVIRONMENTAL CONDITIONS</b>	26deg. C, 61% RH	<b>TESTED BY:</b> Dalen Dai	

No	Freq. [MHz]	Corr. Factor (dB)	Reading Value		Emission Level		Limit		Margin	
			[dB (uV)]		[dB (uV)]		[dB (uV)]		(dB)	
	Q.P.	AV.	Q.P.	AV.	Q.P.	AV.	Q.P.	AV.	Q.P.	AV.
1	0.193	0.30	56.45	41.42	56.75	41.72	63.91	53.91	-7.17	-12.20
2	0.255	0.31	48.41	29.88	48.72	30.19	61.58	51.58	-12.86	-21.39
3	0.326	0.33	40.14	22.04	40.47	22.37	59.56	49.56	-19.09	-27.19
4	1.582	0.53	29.41	15.95	29.94	16.48	56.00	46.00	-26.06	-29.52
5	3.617	0.62	27.54	13.64	28.16	14.26	56.00	46.00	-27.84	-31.74
6	29.117	0.93	36.85	31.25	37.78	32.18	60.00	50.00	-22.22	-17.82

- REMARKS:**
1. Q.P. and AV. are abbreviations of quasi-peak and average individually.
  2. "-": The Quasi-peak reading value also meets average limit and measurement with the average detector is unnecessary.
  3. The emission levels of other frequencies were very low against the limit.
  4. Margin value = Emission level - Limit value
  5. Correction factor = Insertion loss + Cable loss
  6. Emission Level = Correction Factor + Reading Value.

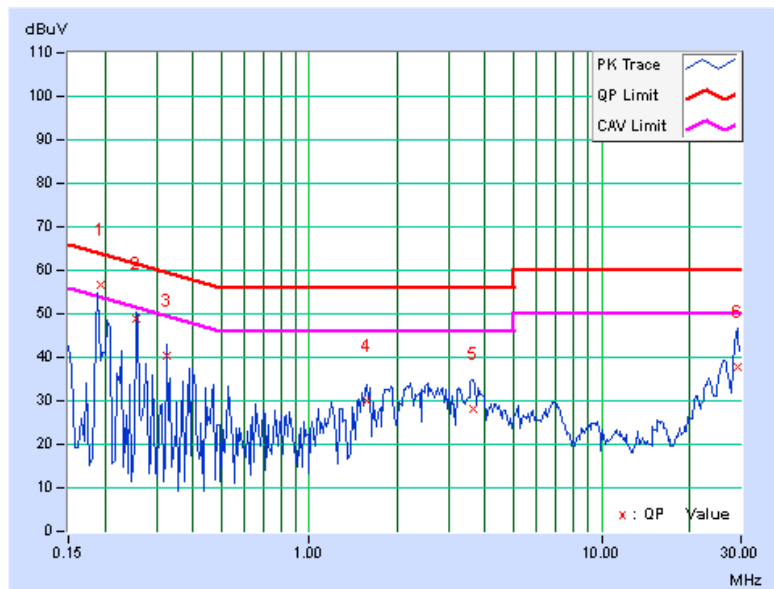



A D T

### 4.1.10 TEST RESULTS (4)

<b>TEST MODE</b>	Mode 4	<b>6dB BANDWIDTH</b>	9 kHz
<b>INPUT POWER</b>	230Vac, 50 Hz	<b>PHASE</b>	Line (L)
<b>ENVIRONMENTAL CONDITIONS</b>	26deg. C, 61% RH	<b>TESTED BY:</b> Dalen Dai	

No	Freq. [MHz]	Corr. Factor (dB)	Reading Value		Emission Level		Limit		Margin	
			[dB (uV)]		[dB (uV)]		[dB (uV)]		(dB)	
			Q.P.	AV.	Q.P.	AV.	Q.P.	AV.	Q.P.	AV.
1	0.201	0.27	55.20	42.46	55.47	42.73	63.58	53.58	-8.11	-10.85
2	0.259	0.28	47.37	34.36	47.65	34.64	61.45	51.45	-13.80	-16.81
3	0.334	0.30	38.48	21.53	38.78	21.83	59.36	49.36	-20.58	-27.53
4	0.740	0.38	30.40	20.86	30.78	21.24	56.00	46.00	-25.22	-24.76
5	2.684	0.54	29.47	18.69	30.01	19.23	56.00	46.00	-25.99	-26.77
6	4.121	0.52	30.61	19.72	31.13	20.24	56.00	46.00	-24.87	-25.76

- REMARKS:**
1. Q.P. and AV. are abbreviations of quasi-peak and average individually.
  2. "-": The Quasi-peak reading value also meets average limit and measurement with the average detector is unnecessary.
  3. The emission levels of other frequencies were very low against the limit.
  4. Margin value = Emission level - Limit value
  5. Correction factor = Insertion loss + Cable loss
  6. Emission Level = Correction Factor + Reading Value.

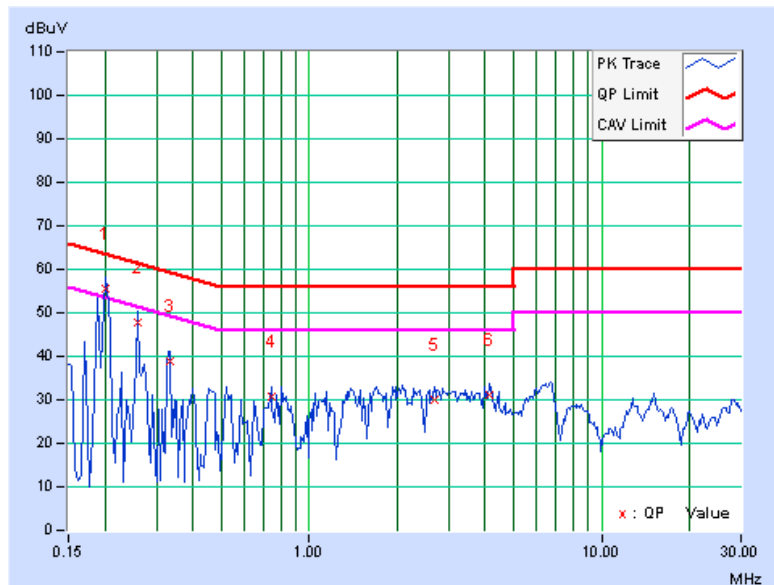





A D T

<b>TEST MODE</b>	Mode 4	<b>6dB BANDWIDTH</b>	9 kHz
<b>INPUT POWER</b>	230Vac, 50 Hz	<b>PHASE</b>	Neutral (N)
<b>ENVIRONMENTAL CONDITIONS</b>	26deg. C, 61% RH	<b>TESTED BY:</b> Dalen Dai	

No	Freq. [MHz]	Corr. Factor (dB)	Reading Value		Emission Level		Limit		Margin	
			[dB (uV)]		[dB (uV)]		[dB (uV)]		(dB)	
			Q.P.	AV.	Q.P.	AV.	Q.P.	AV.	Q.P.	AV.
1	0.193	0.30	55.84	39.96	56.14	40.26	63.91	53.91	-7.77	-13.65
2	0.259	0.31	45.55	32.58	45.86	32.89	61.45	51.45	-15.59	-18.56
3	0.338	0.33	36.83	20.00	37.16	20.33	59.26	49.26	-22.11	-28.94
4	0.470	0.35	30.97	18.88	31.32	19.23	56.51	46.51	-25.18	-27.27
5	2.379	0.59	29.99	15.89	30.58	16.48	56.00	46.00	-25.42	-29.52
6	4.191	0.63	26.26	12.34	26.89	12.97	56.00	46.00	-29.11	-33.03

- REMARKS:**
1. Q.P. and AV. are abbreviations of quasi-peak and average individually.
  2. "-": The Quasi-peak reading value also meets average limit and measurement with the average detector is unnecessary.
  3. The emission levels of other frequencies were very low against the limit.
  4. Margin value = Emission level - Limit value
  5. Correction factor = Insertion loss + Cable loss
  6. Emission Level = Correction Factor + Reading Value.

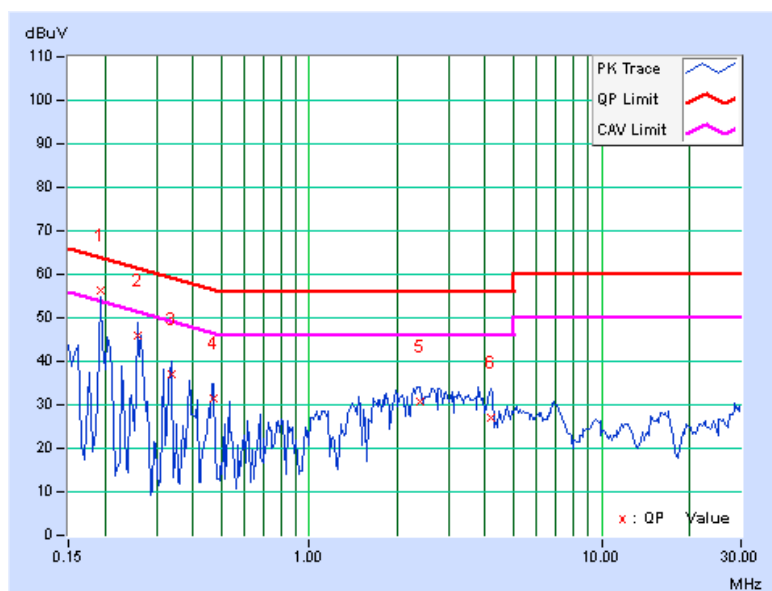



A D T

### 4.1.11 TEST RESULTS (5)

<b>TEST MODE</b>	Mode 5	<b>6dB BANDWIDTH</b>	9 kHz
<b>INPUT POWER</b>	230Vac, 50 Hz	<b>PHASE</b>	Line (L)
<b>ENVIRONMENTAL CONDITIONS</b>	26deg. C, 61% RH	<b>TESTED BY:</b> Dalen Dai	

No	Freq. [MHz]	Corr. Factor (dB)	Reading Value		Emission Level		Limit		Margin	
			[dB (uV)]		[dB (uV)]		[dB (uV)]		(dB)	
			Q.P.	AV.	Q.P.	AV.	Q.P.	AV.	Q.P.	AV.
1	0.197	0.27	57.57	42.81	57.84	43.08	63.74	53.74	-5.90	-10.66
2	0.252	0.28	49.81	32.91	50.09	33.19	61.71	51.71	-11.62	-18.52
3	0.318	0.29	42.04	24.96	42.33	25.25	59.76	49.76	-17.43	-24.51
4	0.396	0.31	39.33	24.60	39.64	24.91	57.93	47.93	-18.30	-23.03
5	3.910	0.52	32.35	17.94	32.87	18.46	56.00	46.00	-23.13	-27.54
6	12.066	0.65	30.30	21.84	30.95	22.49	60.00	50.00	-29.05	-27.51

- REMARKS:**
1. Q.P. and AV. are abbreviations of quasi-peak and average individually.
  2. "-": The Quasi-peak reading value also meets average limit and measurement with the average detector is unnecessary.
  3. The emission levels of other frequencies were very low against the limit.
  4. Margin value = Emission level - Limit value
  5. Correction factor = Insertion loss + Cable loss
  6. Emission Level = Correction Factor + Reading Value.

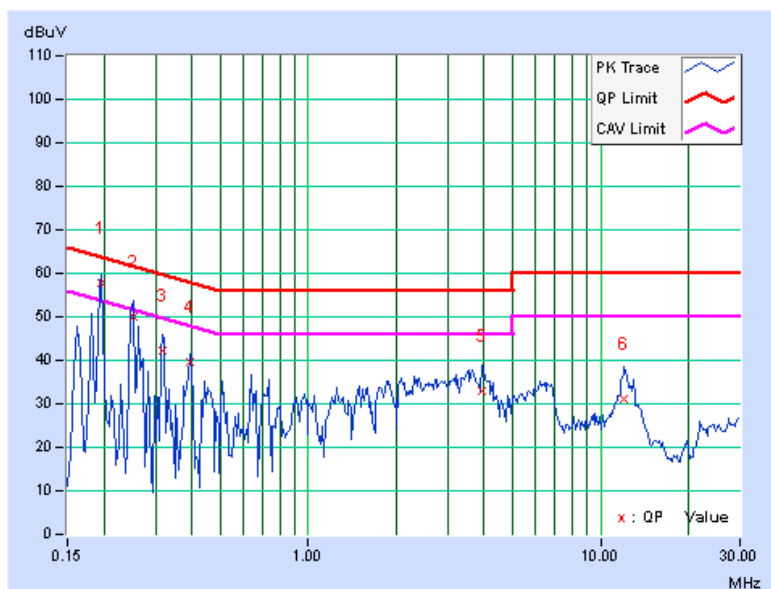

<b>TEST MODE</b>	Mode 5	<b>6dB BANDWIDTH</b>	9 kHz
<b>INPUT POWER</b>	230Vac, 50 Hz	<b>PHASE</b>	Neutral (N)
<b>ENVIRONMENTAL CONDITIONS</b>	26deg. C, 61% RH	<b>TESTED BY:</b> Dalen Dai	

No	Freq. [MHz]	Corr. Factor (dB)	Reading Value		Emission Level		Limit		Margin	
			[dB (uV)]		[dB (uV)]		[dB (uV)]		(dB)	
			Q.P.	AV.	Q.P.	AV.	Q.P.	AV.	Q.P.	AV.
1	0.193	0.30	59.90	46.06	60.20	46.36	63.91	53.91	-3.71	-7.55
2	0.252	0.31	50.82	34.66	51.13	34.97	61.71	51.71	-10.58	-16.74
3	0.318	0.32	42.89	26.15	43.21	26.47	59.76	49.76	-16.55	-23.29
4	0.521	0.36	34.35	22.00	34.71	22.36	56.00	46.00	-21.29	-23.64
5	3.918	0.63	33.73	20.20	34.36	20.83	56.00	46.00	-21.64	-25.17
6	12.414	0.75	30.08	22.79	30.83	23.54	60.00	50.00	-29.17	-26.46

- REMARKS:**
1. Q.P. and AV. are abbreviations of quasi-peak and average individually.
  2. "-": The Quasi-peak reading value also meets average limit and measurement with the average detector is unnecessary.
  3. The emission levels of other frequencies were very low against the limit.
  4. Margin value = Emission level - Limit value
  5. Correction factor = Insertion loss + Cable loss
  6. Emission Level = Correction Factor + Reading Value.

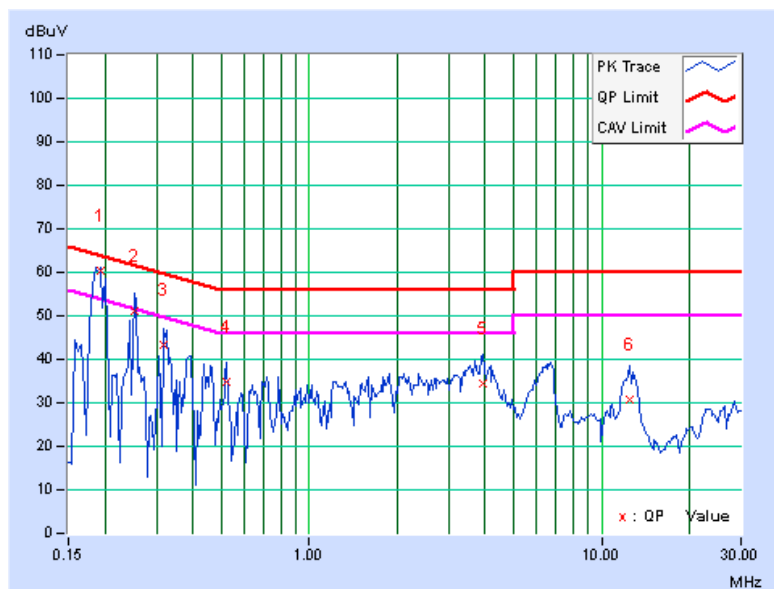



A D T

### 4.1.12 TEST RESULTS (6)

<b>TEST MODE</b>	Mode 6	<b>6dB BANDWIDTH</b>	9 kHz
<b>INPUT POWER</b>	230Vac, 50 Hz	<b>PHASE</b>	Line (L)
<b>ENVIRONMENTAL CONDITIONS</b>	26deg. C, 61% RH	<b>TESTED BY:</b> Dalen Dai	

No	Freq. [MHz]	Corr. Factor (dB)	Reading Value		Emission Level		Limit		Margin	
			[dB (uV)]		[dB (uV)]		[dB (uV)]		(dB)	
			Q.P.	AV.	Q.P.	AV.	Q.P.	AV.	Q.P.	AV.
1	0.197	0.27	57.53	41.08	57.80	41.35	63.74	53.74	-5.94	-12.39
2	0.259	0.28	48.69	32.68	48.97	32.96	61.45	51.45	-12.48	-18.49
3	0.326	0.30	41.10	25.54	41.40	25.84	59.56	49.56	-18.16	-23.72
4	0.384	0.31	37.56	22.32	37.87	22.63	58.18	48.18	-20.32	-25.56
5	0.455	0.32	32.49	19.14	32.81	19.46	56.79	46.79	-23.98	-27.33
6	3.758	0.52	30.40	14.18	30.92	14.70	56.00	46.00	-25.08	-31.30

- REMARKS:**
1. Q.P. and AV. are abbreviations of quasi-peak and average individually.
  2. "-": The Quasi-peak reading value also meets average limit and measurement with the average detector is unnecessary.
  3. The emission levels of other frequencies were very low against the limit.
  4. Margin value = Emission level - Limit value
  5. Correction factor = Insertion loss + Cable loss
  6. Emission Level = Correction Factor + Reading Value.

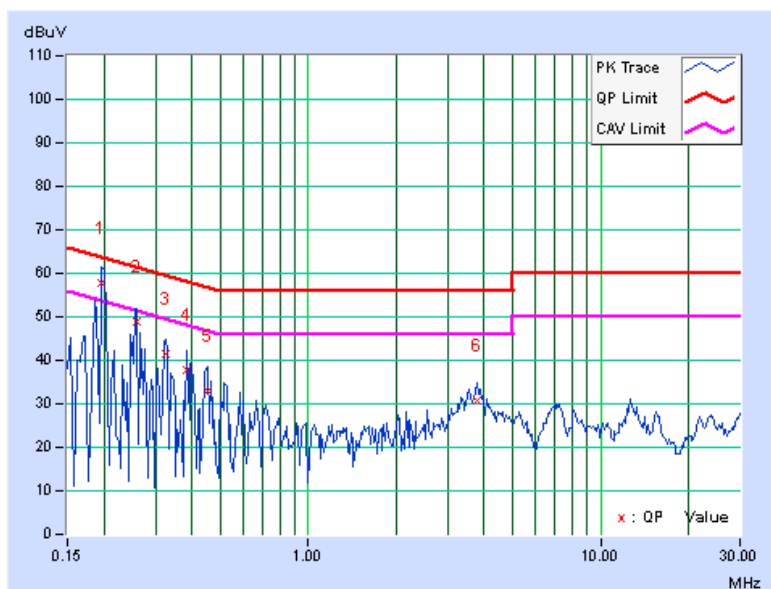



A D T

<b>TEST MODE</b>	Mode 6	<b>6dB BANDWIDTH</b>	9 kHz
<b>INPUT POWER</b>	230Vac, 50 Hz	<b>PHASE</b>	Neutral (N)
<b>ENVIRONMENTAL CONDITIONS</b>	26deg. C, 61% RH	<b>TESTED BY:</b> Dalen Dai	

No	Freq. [MHz]	Corr. Factor (dB)	Reading Value		Emission Level		Limit		Margin	
			[dB (uV)]		[dB (uV)]		[dB (uV)]		(dB)	
	Q.P.	AV.	Q.P.	AV.	Q.P.	AV.	Q.P.	AV.	Q.P.	AV.
1	0.193	0.30	57.09	41.71	57.39	42.01	63.91	53.91	-6.52	-11.90
2	0.263	0.31	47.78	31.28	48.09	31.59	61.33	51.33	-13.23	-19.73
3	0.314	0.32	38.65	16.03	38.97	16.35	59.86	49.86	-20.89	-33.51
4	0.388	0.34	36.23	20.52	36.57	20.86	58.10	48.10	-21.53	-27.24
5	3.875	0.63	28.83	15.87	29.46	16.50	56.00	46.00	-26.54	-29.50
6	12.250	0.75	24.74	17.61	25.49	18.36	60.00	50.00	-34.51	-31.64

- REMARKS:**
1. Q.P. and AV. are abbreviations of quasi-peak and average individually.
  2. "-": The Quasi-peak reading value also meets average limit and measurement with the average detector is unnecessary.
  3. The emission levels of other frequencies were very low against the limit.
  4. Margin value = Emission level - Limit value
  5. Correction factor = Insertion loss + Cable loss
  6. Emission Level = Correction Factor + Reading Value.

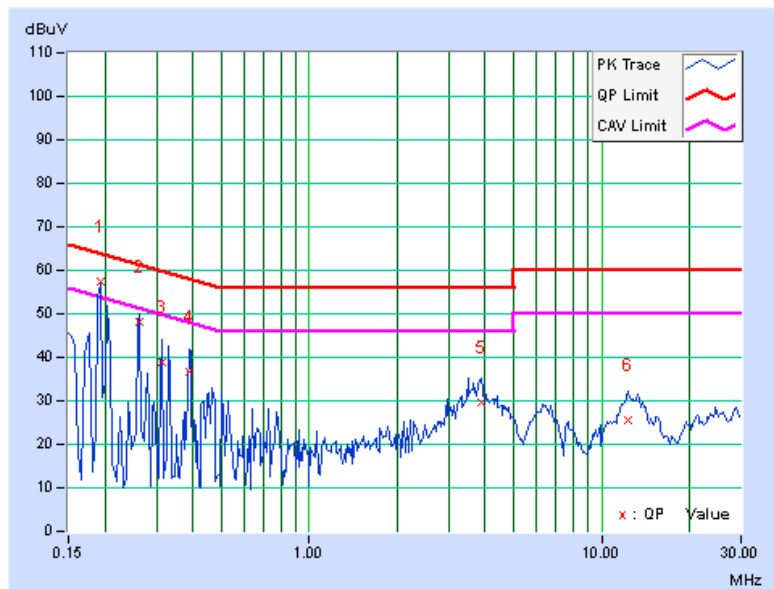



A D T

### 4.1.13 TEST RESULTS (7)

<b>TEST MODE</b>	Mode 7	<b>6dB BANDWIDTH</b>	9 kHz
<b>INPUT POWER</b>	230Vac, 50 Hz	<b>PHASE</b>	Line (L)
<b>ENVIRONMENTAL CONDITIONS</b>	26deg. C, 61% RH	<b>TESTED BY:</b> Dalen Dai	

No	Freq. [MHz]	Corr. Factor (dB)	Reading Value		Emission Level		Limit		Margin	
			[dB (uV)]		[dB (uV)]		[dB (uV)]		(dB)	
			Q.P.	AV.	Q.P.	AV.	Q.P.	AV.	Q.P.	AV.
1	0.197	0.27	59.11	42.38	59.38	42.65	63.74	53.74	-4.36	-11.09
2	0.255	0.28	50.99	-	51.27	-	61.58	51.58	-10.31	-
3	0.318	0.29	43.38	-	43.67	-	59.76	49.76	-16.09	-
4	0.380	0.31	39.40	-	39.71	-	58.27	48.27	-18.56	-
5	0.455	0.32	36.04	-	36.36	-	56.79	46.79	-20.43	-
6	13.332	0.67	28.37	-	29.04	-	60.00	50.00	-30.96	-

- REMARKS:**
1. Q.P. and AV. are abbreviations of quasi-peak and average individually.
  2. "-": The Quasi-peak reading value also meets average limit and measurement with the average detector is unnecessary.
  3. The emission levels of other frequencies were very low against the limit.
  4. Margin value = Emission level - Limit value
  5. Correction factor = Insertion loss + Cable loss
  6. Emission Level = Correction Factor + Reading Value.

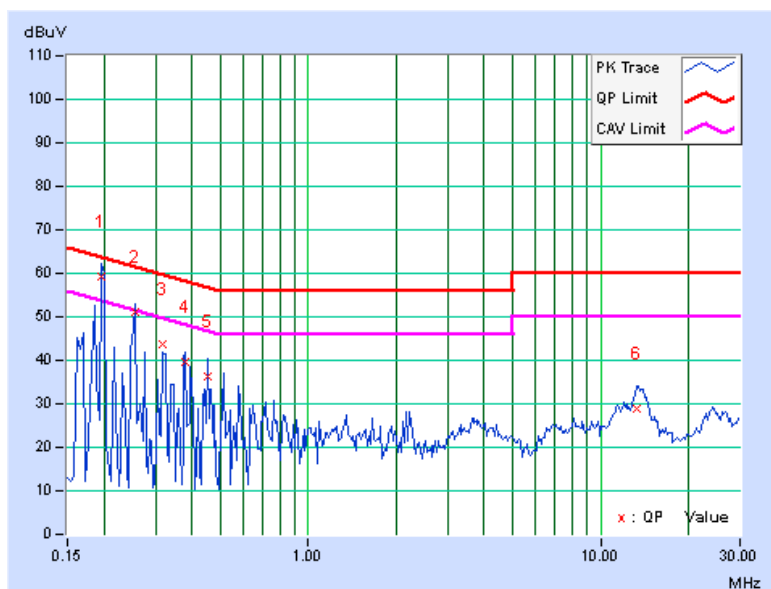



A D T

<b>TEST MODE</b>	Mode 7	<b>6dB BANDWIDTH</b>	9 kHz
<b>INPUT POWER</b>	230Vac, 50 Hz	<b>PHASE</b>	Neutral (N)
<b>ENVIRONMENTAL CONDITIONS</b>	26deg. C, 61% RH	<b>TESTED BY:</b> Dalen Dai	

No	Freq. [MHz]	Corr. Factor (dB)	Reading Value		Emission Level		Limit		Margin	
			[dB (uV)]		[dB (uV)]		[dB (uV)]		(dB)	
			Q.P.	AV.	Q.P.	AV.	Q.P.	AV.	Q.P.	AV.
1	0.189	0.29	58.91	40.89	59.20	41.18	64.08	54.08	-4.87	-12.89
2	0.255	0.31	50.43	33.03	50.74	33.34	61.58	51.58	-10.84	-18.24
3	0.326	0.33	41.79	23.70	42.12	24.03	59.56	49.56	-17.44	-25.53
4	0.392	0.34	36.92	19.75	37.26	20.09	58.02	48.02	-20.76	-27.93
5	0.445	0.35	34.67	17.79	35.02	18.14	56.96	46.96	-21.94	-28.82
6	13.883	0.77	29.30	24.03	30.07	24.80	60.00	50.00	-29.93	-25.20

- REMARKS:**
1. Q.P. and AV. are abbreviations of quasi-peak and average individually.
  2. "-": The Quasi-peak reading value also meets average limit and measurement with the average detector is unnecessary.
  3. The emission levels of other frequencies were very low against the limit.
  4. Margin value = Emission level - Limit value
  5. Correction factor = Insertion loss + Cable loss
  6. Emission Level = Correction Factor + Reading Value.

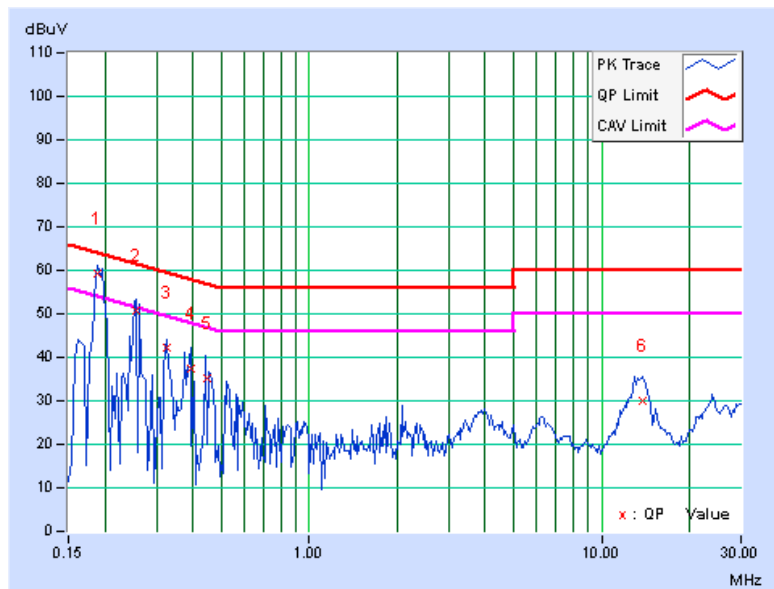



A D T

### 4.1.14 TEST RESULTS (8)

<b>TEST MODE</b>	Mode 8	<b>6dB BANDWIDTH</b>	9 kHz
<b>INPUT POWER</b>	230Vac, 50 Hz	<b>PHASE</b>	Line (L)
<b>ENVIRONMENTAL CONDITIONS</b>	26deg. C, 61% RH	<b>TESTED BY:</b> Dalen Dai	

No	Freq. [MHz]	Corr. Factor (dB)	Reading Value		Emission Level		Limit		Margin	
			[dB (uV)]		[dB (uV)]		[dB (uV)]		(dB)	
			Q.P.	AV.	Q.P.	AV.	Q.P.	AV.	Q.P.	AV.
1	0.204	0.27	60.47	44.21	60.74	44.48	63.47	53.47	-2.73	-8.99
2	0.267	0.28	51.44	35.28	51.72	35.56	61.20	51.20	-9.48	-15.64
3	0.338	0.30	44.17	27.78	44.47	28.08	59.26	49.26	-14.80	-21.19
4	2.660	0.54	39.32	28.15	39.86	28.69	56.00	46.00	-16.14	-17.31
5	20.961	0.83	39.95	33.42	40.78	34.25	60.00	50.00	-19.22	-15.75
6	29.602	0.54	40.63	34.95	41.17	35.49	60.00	50.00	-18.83	-14.51

- REMARKS:**
1. Q.P. and AV. are abbreviations of quasi-peak and average individually.
  2. "-": The Quasi-peak reading value also meets average limit and measurement with the average detector is unnecessary.
  3. The emission levels of other frequencies were very low against the limit.
  4. Margin value = Emission level - Limit value
  5. Correction factor = Insertion loss + Cable loss
  6. Emission Level = Correction Factor + Reading Value.

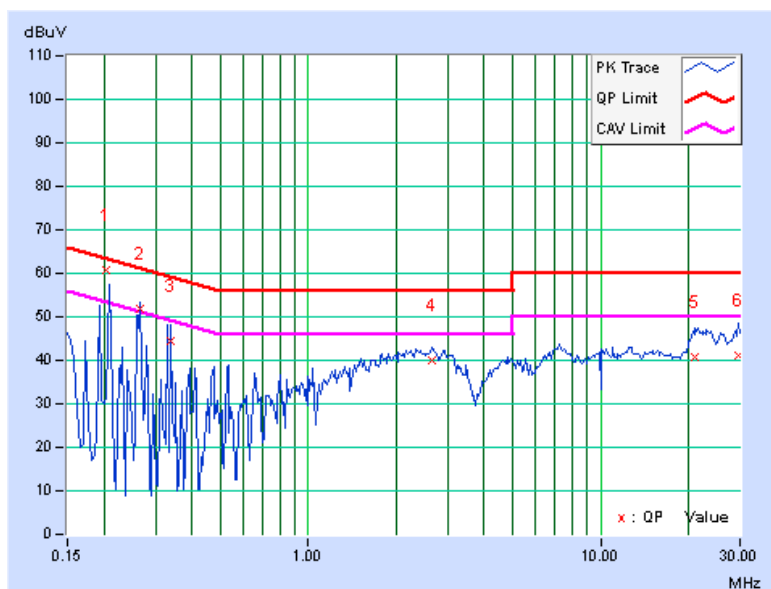





A D T

<b>TEST MODE</b>	Mode 8	<b>6dB BANDWIDTH</b>	9 kHz
<b>INPUT POWER</b>	230Vac, 50 Hz	<b>PHASE</b>	Neutral (N)
<b>ENVIRONMENTAL CONDITIONS</b>	26deg. C, 61% RH	<b>TESTED BY:</b> Dalen Dai	

No	Freq. [MHz]	Corr. Factor (dB)	Reading Value		Emission Level		Limit		Margin	
			[dB (uV)]		[dB (uV)]		[dB (uV)]		(dB)	
	Q.P.	AV.	Q.P.	AV.	Q.P.	AV.	Q.P.	AV.	Q.P.	AV.
1	0.197	0.30	62.24	46.16	62.54	46.46	63.74	53.74	-1.20	-7.28
2	0.271	0.31	52.90	36.72	53.21	37.03	61.08	51.08	-7.87	-14.05
3	0.334	0.33	45.14	28.20	45.47	28.53	59.36	49.36	-13.89	-20.83
4	0.533	0.37	36.24	22.17	36.61	22.54	56.00	46.00	-19.39	-23.46
5	2.309	0.59	38.58	25.76	39.17	26.35	56.00	46.00	-16.83	-19.65
6	29.047	0.93	41.33	35.99	42.26	36.92	60.00	50.00	-17.74	-13.08

- REMARKS:**
1. Q.P. and AV. are abbreviations of quasi-peak and average individually.
  2. "-": The Quasi-peak reading value also meets average limit and measurement with the average detector is unnecessary.
  3. The emission levels of other frequencies were very low against the limit.
  4. Margin value = Emission level - Limit value
  5. Correction factor = Insertion loss + Cable loss
  6. Emission Level = Correction Factor + Reading Value.

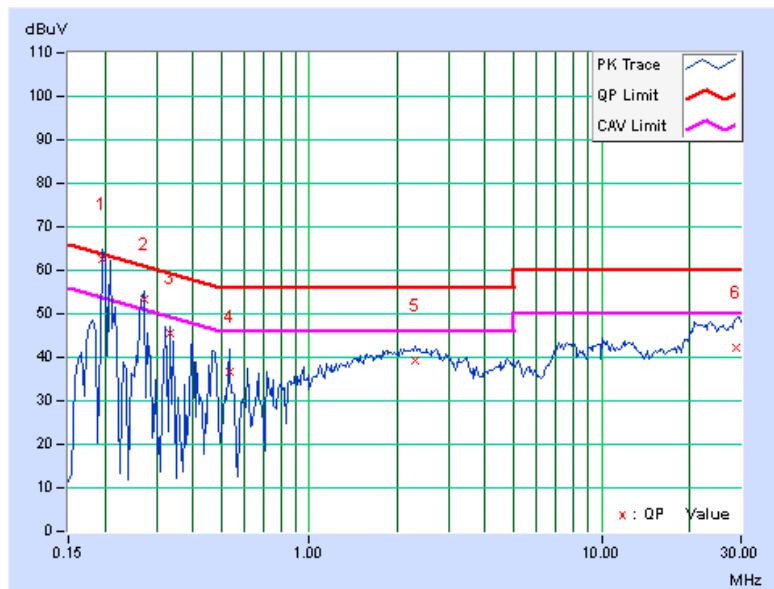

## 4.2 RADIATED EMISSION MEASUREMENT

### 4.2.1 LIMITS OF RADIATED EMISSION MEASUREMENT

**TEST STANDARD: EN 55022 / EN 61204-3**

#### FOR FREQUENCY BELOW 1000 MHz

FREQUENCY (MHz)	Class A (at 10m)	Class B (at 10m)
	dBuV/m	dBuV/m
30 – 230	40	30
230 – 1000	47	37

**TEST STANDARD: EN 55022**

#### FOR FREQUENCY ABOVE 1000 MHz

FREQUENCY (GHz)	Class A (dBuV/m) (at 3m)		Class B (dBuV/m) (at 3m)	
	PEAK	AVERAGE	PEAK	AVERAGE
1 to 3	76	56	70	50
3 to 6	80	60	74	54

- NOTE:** (1) The lower limit shall apply at the transition frequencies.  
 (2) Emission level (dBuV/m) = 20 log Emission level (uV/m).  
 (3) All emanation from a class A/B digital device or system, including any network of conductors and apparatus connected thereto, shall not exceed the level of field strengths specified above.

### FREQUENCY RANGE OF RADIATED MEASUREMENT (For unintentional radiators)

Highest frequency generated or used in the device or on which the device operates or tunes (MHz)	Upper frequency of measurement Range (MHz)
Below 108	1000
108 – 500	2000
500 – 1000	5000
Above 1000	Up to 5 times of the highest frequency or 6 GHz, whichever is less



A D T

## 4.2.2 TEST INSTRUMENTS

DESCRIPTION & MANUFACTURER	MODEL NO.	SERIAL NO.	CALIBRATED DATE	CALIBRATED UNTIL
Agilent Preamplifier	8447D	2944A11062	Mar. 04, 2011	Mar. 03, 2012
Agilent Preamplifier	8447D	2944A11064	Mar. 04, 2011	Mar. 03, 2012
Agilent Test Spectrum	E4443A	MY46182050	Aug. 02, 2011	Aug. 01, 2012
Agilent Test Spectrum	E4443A	MY46182049	Jul. 27, 2011	Jul. 26, 2012
Agilent Test Preselector	N9039A	MY46520284	Aug. 02, 2011	Aug. 01, 2012
Agilent Test Preselector	N9039A	MY46520283	Jul. 27, 2011	Jul. 26, 2012
Agilent Signal Generator	N5181A	MY47421329	Jul. 27, 2011	Jul. 26, 2012
Schwarzbeck Antenna	VULB9168	9168-316	Apr. 15, 2011	Apr. 14, 2012
Schwarzbeck Antenna	VULB9168	9168-317	Apr. 18, 2011	Apr. 17, 2012
Max Full. Turn Table & Tower	MF7802	MF7802121	NA	NA
Max Full. Tower	MF7802	MF780208105	NA	NA
Software	ADT_Radiated_V8.7.03.5	NA	NA	NA
WOKEN RF cable	8D	CABLE-CH8-0 1.V	Dec. 23, 2010	Dec. 22, 2011
JYE BAO RF cable	8D	CABLE-CH8-0 2.H	Dec. 23, 2010	Dec. 22, 2011
JYE BAO RF cable	8D	CABLE-CH8-0 3.3M	Dec. 23, 2010	Dec. 22, 2011

- NOTE:**
1. The calibration interval of the above test instruments is 12 months. And the calibrations are traceable to NML/ROC and NIST/USA.
  2. The test was performed in Chamber No. 8.
  3. The Industry Canada Reference No. IC 7450E-8.
  4. The VCCI Site Registration No. R-2946
  5. The FCC Site Registration No. 493821.

### 4.2.3 TEST PROCEDURE

- a. The EUT was placed on the top of a rotating table 0.8 meters above the ground at a 10-meter Semi-anechoic chamber room. The table was rotated 360 degrees to determine the position of the highest radiation.
- b. The EUT was set 10 meters away from the interference-receiving antenna, which was mounted on the top of a variable-height antenna tower.
- c. The height of antenna is varied from one meter to four meters above the ground to determine the maximum value of the field strength. Both horizontal and vertical polarizations of the antenna are set to make the measurement.
- d. For each suspected emission, the EUT was arranged to its worst case and then the antenna was tuned to heights from 1 meter to 4 meters and the turn table was turned from 0 degrees to 360 degrees to find the maximum reading.
- e. The test-receiver system was set to quasi-peak detect function and specified bandwidth with maximum hold mode when the test frequency is below 1 GHz.

**NOTE:** The resolution bandwidth of test receiver/spectrum analyzer is 120kHz for Quasi-peak detection (QP) at frequency below 1GHz.

### 4.2.4 DEVIATION FROM TEST STANDARD

No deviation

## 4.2.5 TEST SETUP

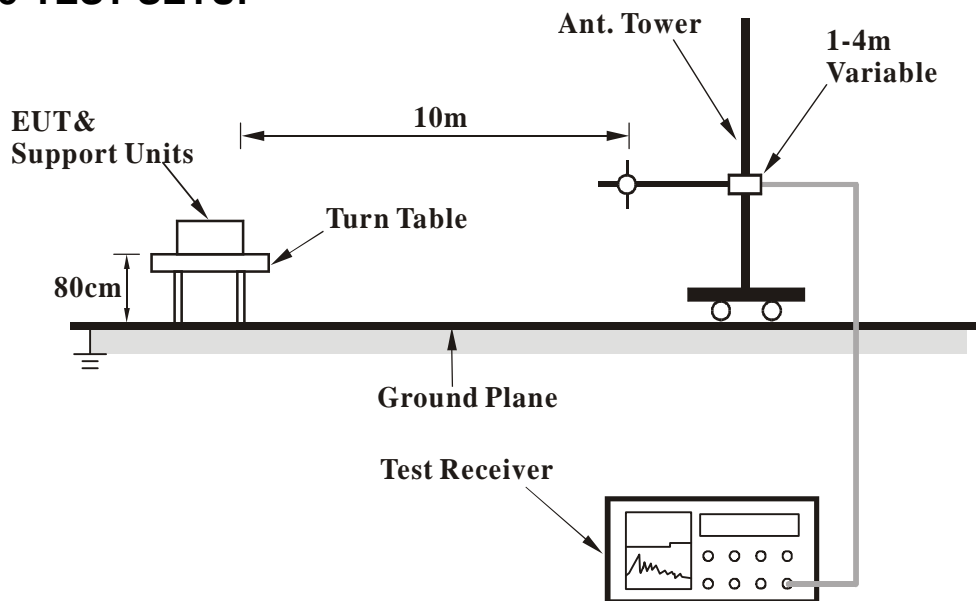

For the actual test configuration, please refer to the related item – Photographs of the Test Configuration.

## 4.2.6 EUT OPERATING CONDITIONS

Same as item 4.1.6.



A D T

### 4.2.7 TEST RESULTS (1)

<b>TEST MODE</b>	Mode 1		
<b>FREQUENCY RANGE</b>	30-1000 MHz	<b>DETECTOR FUNCTION &amp; BANDWIDTH</b>	Quasi-Peak, 120kHz
<b>ENVIRONMENTAL CONDITIONS</b>	24deg. C, 68% RH	<b>TESTED BY:</b> Mars Wang	

#### ANTENNA POLARITY & TEST DISTANCE: HORIZONTAL AT 10 M

No.	Freq. (MHz)	Emission Level (dBuV/m)	Limit (dBuV/m)	Margin (dB)	Antenna Height (m)	Table Angle (Degree)	Raw Value (dBuV)	Correction Factor (dB/m)
1	40.89	23.16 QP	30.00	-6.84	4.00 H	74	8.76	14.40
2	54.63	18.61 QP	30.00	-11.39	4.00 H	184	4.94	13.67
3	70.15	19.22 QP	30.00	-10.78	4.00 H	246	6.80	12.42
4	117.16	21.35 QP	30.00	-8.65	4.00 H	127	9.17	12.18
5	145.58	24.08 QP	30.00	-5.92	4.00 H	171	9.73	14.35
6	155.88	20.98 QP	30.00	-9.02	4.00 H	118	6.28	14.70

- REMARKS:**
1. Emission level(dBuV/m)=Raw Value(dBuV) + Correction Factor(dB/m)
  2. Correction Factor(dB/m) = Antenna Factor (dB/m) + Cable Factor (dB)
  3. The other emission levels were very low against the limit.
  4. Margin value = Emission level – Limit value.

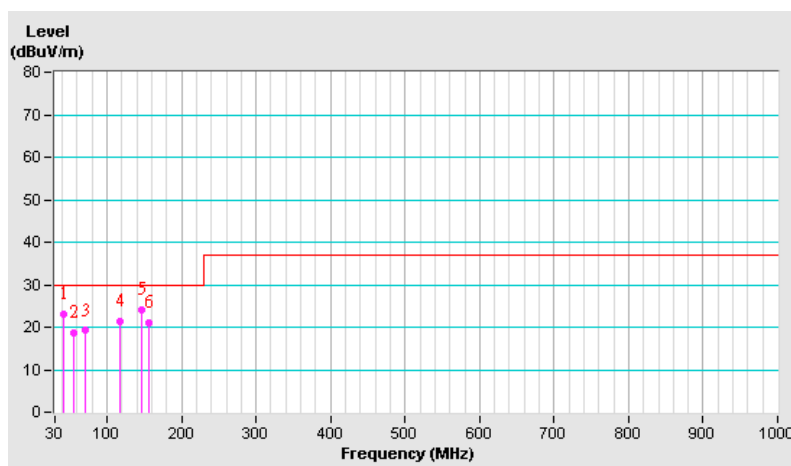



A D T

<b>TEST MODE</b>	Mode 1		
<b>FREQUENCY RANGE</b>	30-1000 MHz	<b>DETECTOR FUNCTION &amp; BANDWIDTH</b>	Quasi-Peak, 120kHz
<b>ENVIRONMENTAL CONDITIONS</b>	24deg. C, 68% RH	<b>TESTED BY:</b> Mars Wang	

**ANTENNA POLARITY & TEST DISTANCE: VERTICAL AT 10 M**

No.	Freq. (MHz)	Emission Level (dBuV/m)	Limit (dBuV/m)	Margin (dB)	Antenna Height (m)	Table Angle (Degree)	Raw Value (dBuV)	Correction Factor (dB/m)
1	30.12	24.99 QP	30.00	-5.01	1.00 V	332	12.77	12.22
2	37.46	23.26 QP	30.00	-6.74	1.00 V	22	9.95	13.31
3	48.59	25.18 QP	30.00	-4.82	1.00 V	332	11.07	14.11
4	78.20	23.81 QP	30.00	-6.19	1.87 V	147	13.57	10.24
5	85.90	24.33 QP	30.00	-5.67	1.49 V	332	15.21	9.12
6	119.17	21.53 QP	30.00	-8.47	1.00 V	359	9.18	12.35

- REMARKS:**
1. Emission level(dBuV/m)=Raw Value(dBuV) + Correction Factor(dB/m)
  2. Correction Factor(dB/m) = Antenna Factor (dB/m) + Cable Factor (dB)
  3. The other emission levels were very low against the limit.
  4. Margin value = Emission level – Limit value.

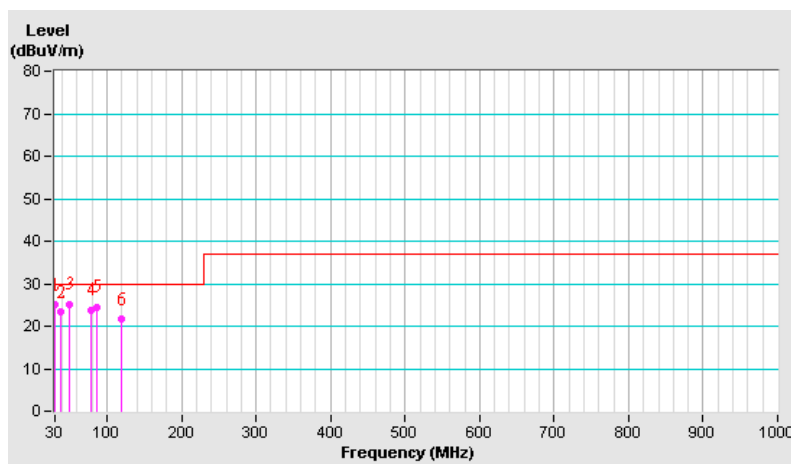



### 4.2.8 TEST RESULTS (2)

<b>TEST MODE</b>	Mode 2		
<b>FREQUENCY RANGE</b>	30-1000 MHz	<b>DETECTOR FUNCTION &amp; BANDWIDTH</b>	Quasi-Peak, 120kHz
<b>ENVIRONMENTAL CONDITIONS</b>	24deg. C, 68% RH	<b>TESTED BY:</b> Mars Wang	

#### ANTENNA POLARITY & TEST DISTANCE: HORIZONTAL AT 10 M

No.	Freq. (MHz)	Emission Level (dBuV/m)	Limit (dBuV/m)	Margin (dB)	Antenna Height (m)	Table Angle (Degree)	Raw Value (dBuV)	Correction Factor (dB/m)
1	46.46	25.35 QP	30.00	-4.65	3.96 H	210	11.33	14.02
2	53.09	18.70 QP	30.00	-11.30	3.84 H	178	4.94	13.76
3	101.05	20.11 QP	30.00	-9.89	3.89 H	253	10.13	9.98
4	110.41	18.82 QP	30.00	-11.18	3.97 H	162	7.56	11.26
5	126.63	18.98 QP	30.00	-11.02	3.72 H	253	5.90	13.08
6	193.54	18.72 QP	30.00	-11.28	3.80 H	211	6.56	12.16

- REMARKS:**
1. Emission level(dBuV/m)=Raw Value(dBuV) + Correction Factor(dB/m)
  2. Correction Factor(dB/m) = Antenna Factor (dB/m) + Cable Factor (dB)
  3. The other emission levels were very low against the limit.
  4. Margin value = Emission level – Limit value.

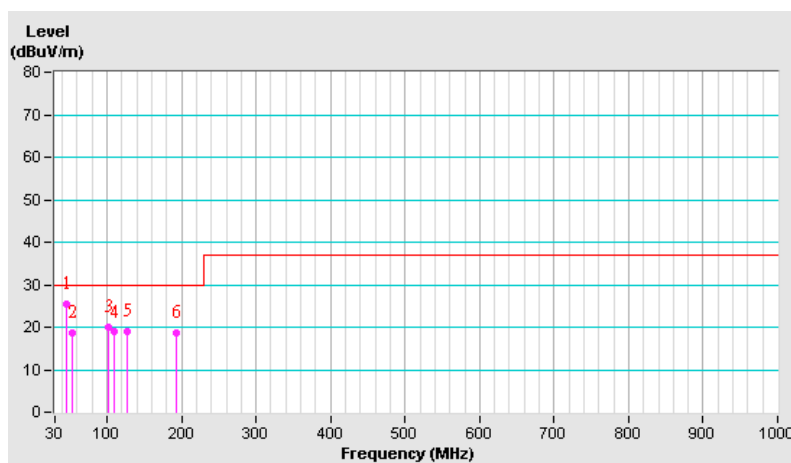





A D T

<b>TEST MODE</b>	Mode 2		
<b>FREQUENCY RANGE</b>	30-1000 MHz	<b>DETECTOR FUNCTION &amp; BANDWIDTH</b>	Quasi-Peak, 120kHz
<b>ENVIRONMENTAL CONDITIONS</b>	24deg. C, 68% RH	<b>TESTED BY:</b> Mars Wang	

**ANTENNA POLARITY & TEST DISTANCE: VERTICAL AT 10 M**

No.	Freq. (MHz)	Emission Level (dBuV/m)	Limit (dBuV/m)	Margin (dB)	Antenna Height (m)	Table Angle (Degree)	Raw Value (dBuV)	Correction Factor (dB/m)
1	35.33	27.07 QP	30.00	-2.93	1.07 V	86	14.18	12.89
2	46.82	26.64 QP	30.00	-3.36	1.04 V	346	12.59	14.05
<b>3</b>	<b>76.54</b>	<b>27.75 QP</b>	<b>30.00</b>	<b>-2.25</b>	<b>1.16 V</b>	<b>315</b>	<b>17.12</b>	<b>10.63</b>
4	85.90	22.62 QP	30.00	-7.38	1.35 V	116	13.50	9.12
5	93.83	23.67 QP	30.00	-6.33	1.29 V	47	14.53	9.14
6	101.29	23.90 QP	30.00	-6.10	1.23 V	44	13.80	10.10

- REMARKS:**
1. Emission level(dBuV/m)=Raw Value(dBuV) + Correction Factor(dB/m)
  2. Correction Factor(dB/m) = Antenna Factor (dB/m) + Cable Factor (dB)
  3. The other emission levels were very low against the limit.
  4. Margin value = Emission level – Limit value.

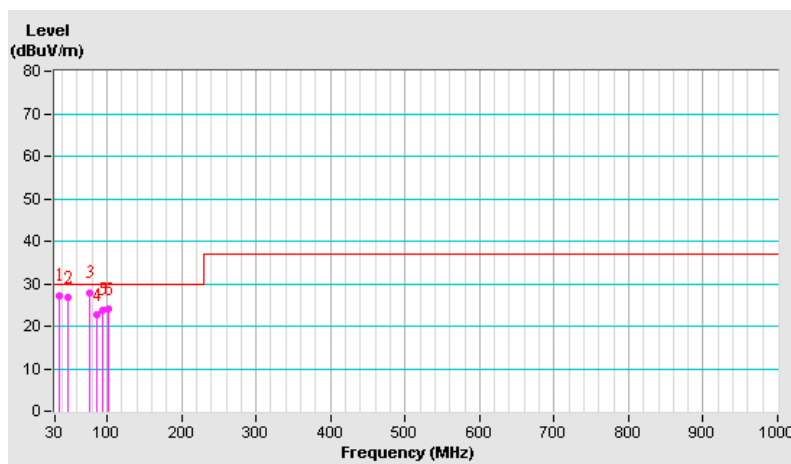



A D T

### 4.2.9 TEST RESULTS (3)

<b>TEST MODE</b>	Mode 3		
<b>FREQUENCY RANGE</b>	30-1000 MHz	<b>DETECTOR FUNCTION &amp; BANDWIDTH</b>	Quasi-Peak, 120kHz
<b>ENVIRONMENTAL CONDITIONS</b>	24deg. C, 68% RH	<b>TESTED BY:</b> Mars Wang	

#### ANTENNA POLARITY & TEST DISTANCE: HORIZONTAL AT 10 M

No.	Freq. (MHz)	Emission Level (dBuV/m)	Limit (dBuV/m)	Margin (dB)	Antenna Height (m)	Table Angle (Degree)	Raw Value (dBuV)	Correction Factor (dB/m)
1	48.24	18.57 QP	30.00	-11.43	3.98 H	204	4.58	13.99
2	110.65	16.96 QP	30.00	-13.04	3.85 H	148	5.67	11.29
3	114.67	21.28 QP	30.00	-8.72	3.89 H	142	9.44	11.84
4	123.67	19.03 QP	30.00	-10.97	3.74 H	162	6.18	12.85
5	161.45	14.78 QP	30.00	-15.22	3.90 H	184	0.05	14.73
6	174.95	17.26 QP	30.00	-12.74	3.96 H	236	3.24	14.02

- REMARKS:**
1. Emission level(dBuV/m)=Raw Value(dBuV) + Correction Factor(dB/m)
  2. Correction Factor(dB/m) = Antenna Factor (dB/m) + Cable Factor (dB)
  3. The other emission levels were very low against the limit.
  4. Margin value = Emission level – Limit value.

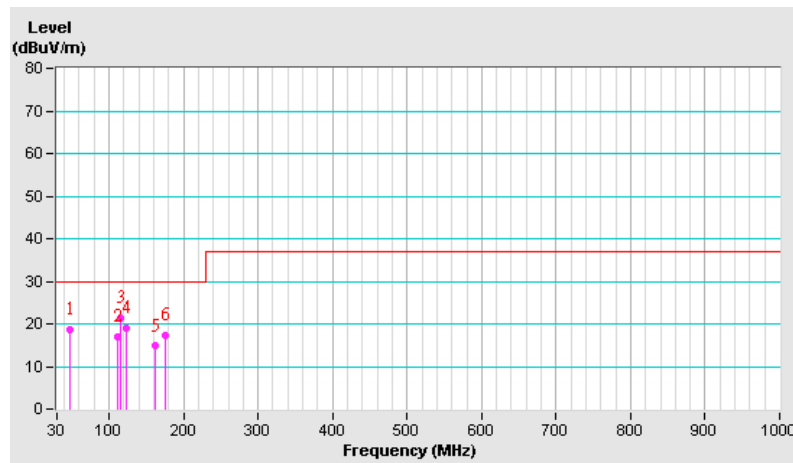



A D T

<b>TEST MODE</b>	Mode 3		
<b>FREQUENCY RANGE</b>	30-1000 MHz	<b>DETECTOR FUNCTION &amp; BANDWIDTH</b>	Quasi-Peak, 120kHz
<b>ENVIRONMENTAL CONDITIONS</b>	24deg. C, 68% RH	<b>TESTED BY:</b> Mars Wang	

**ANTENNA POLARITY & TEST DISTANCE: VERTICAL AT 10 M**

No.	Freq. (MHz)	Emission Level (dBuV/m)	Limit (dBuV/m)	Margin (dB)	Antenna Height (m)	Table Angle (Degree)	Raw Value (dBuV)	Correction Factor (dB/m)
1	35.57	22.24 QP	30.00	-7.76	1.02 V	21	9.30	12.94
2	47.41	21.52 QP	30.00	-8.48	1.09 V	357	7.45	14.07
3	76.54	22.65 QP	30.00	-7.35	1.01 V	312	12.02	10.63
4	95.96	23.33 QP	30.00	-6.67	1.14 V	65	13.92	9.41
5	106.50	20.65 QP	30.00	-9.35	1.25 V	292	9.89	10.76
6	114.79	21.51 QP	30.00	-8.49	1.17 V	19	9.71	11.80

- REMARKS:**
1. Emission level(dBuV/m)=Raw Value(dBuV) + Correction Factor(dB/m)
  2. Correction Factor(dB/m) = Antenna Factor (dB/m) + Cable Factor (dB)
  3. The other emission levels were very low against the limit.
  4. Margin value = Emission level – Limit value.

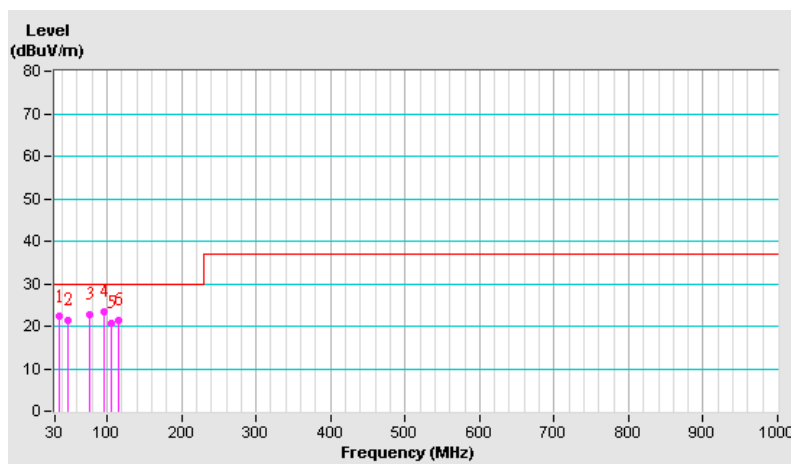



### 4.2.10 TEST RESULTS (4)

<b>TEST MODE</b>	Mode 4		
<b>FREQUENCY RANGE</b>	30-1000 MHz	<b>DETECTOR FUNCTION &amp; BANDWIDTH</b>	Quasi-Peak, 120kHz
<b>ENVIRONMENTAL CONDITIONS</b>	24deg. C, 68% RH	<b>TESTED BY:</b> Mars Wang	

ANTENNA POLARITY & TEST DISTANCE: HORIZONTAL AT 10 M								
No.	Freq. (MHz)	Emission Level (dBuV/m)	Limit (dBuV/m)	Margin (dB)	Antenna Height (m)	Table Angle (Degree)	Raw Value (dBuV)	Correction Factor (dB/m)
1	47.53	17.52 QP	30.00	-12.48	3.89 H	211	3.52	14.00
2	111.59	18.70 QP	30.00	-11.30	3.95 H	158	7.28	11.42
3	119.76	15.06 QP	30.00	-14.94	3.76 H	169	2.52	12.54
4	152.09	15.95 QP	30.00	-14.05	3.82 H	342	1.35	14.60
5	168.32	15.02 QP	30.00	-14.98	3.99 H	24	0.65	14.37
6	177.67	16.61 QP	30.00	-13.39	3.72 H	28	2.96	13.65

- REMARKS:**
1. Emission level(dBuV/m)=Raw Value(dBuV) + Correction Factor(dB/m)
  2. Correction Factor(dB/m) = Antenna Factor (dB/m) + Cable Factor (dB)
  3. The other emission levels were very low against the limit.
  4. Margin value = Emission level – Limit value.

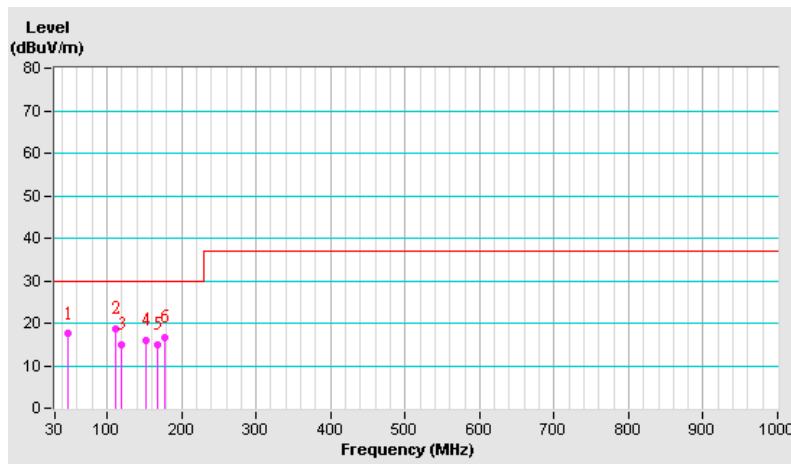



A D T

<b>TEST MODE</b>	Mode 4		
<b>FREQUENCY RANGE</b>	30-1000 MHz	<b>DETECTOR FUNCTION &amp; BANDWIDTH</b>	Quasi-Peak, 120kHz
<b>ENVIRONMENTAL CONDITIONS</b>	24deg. C, 68% RH	<b>TESTED BY:</b> Mars Wang	

**ANTENNA POLARITY & TEST DISTANCE: VERTICAL AT 10 M**

No.	Freq. (MHz)	Emission Level (dBuV/m)	Limit (dBuV/m)	Margin (dB)	Antenna Height (m)	Table Angle (Degree)	Raw Value (dBuV)	Correction Factor (dB/m)
1	35.33	21.44 QP	30.00	-8.56	1.09 V	30	8.55	12.89
2	78.67	23.53 QP	30.00	-6.47	1.04 V	322	13.40	10.13
3	87.43	21.47 QP	30.00	-8.53	1.18 V	53	12.53	8.94
4	96.44	21.41 QP	30.00	-8.59	1.13 V	56	11.93	9.48
5	110.65	19.46 QP	30.00	-10.54	1.24 V	77	8.18	11.28
6	178.38	22.12 QP	30.00	-7.88	1.43 V	56	8.76	13.36

- REMARKS:**
1. Emission level(dBuV/m)=Raw Value(dBuV) + Correction Factor(dB/m)
  2. Correction Factor(dB/m) = Antenna Factor (dB/m) + Cable Factor (dB)
  3. The other emission levels were very low against the limit.
  4. Margin value = Emission level – Limit value.

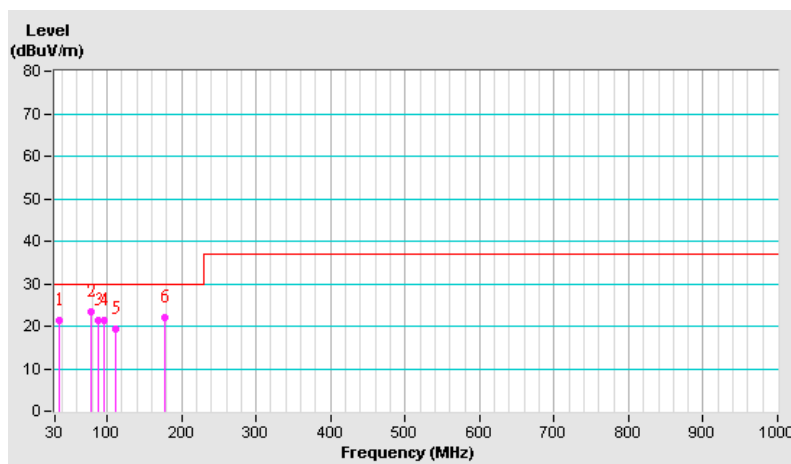



### 4.3 HARMONICS CURRENT MEASUREMENT

#### 4.3.1 LIMITS OF HARMONICS CURRENT MEASUREMENT

##### TEST STANDARD: IEC 61000-3-2 / EN 61000-3-2

Limits for Class A equipment	
Harmonics Order n	Max. permissible harmonics current A
Odd harmonics	
3	2.30
5	1.14
7	0.77
9	0.40
11	0.33
13	0.21
15<=n<=39	0.15x15/n
Even harmonics	
2	1.08
4	0.43
6	0.30
8<=n<=40	0.23x8/n

Limits for Class D equipment		
Harmonics Order n	Max. permissible harmonics current per watt mAW	Max. permissible harmonics current A
Odd Harmonics only		
3	3.4	2.30
5	1.9	1.14
7	1.0	0.77
9	0.5	0.40
11	0.35	0.33
13	0.30	0.21
15<=n<=39	3.85/n	0.15x15/n

- NOTE:** 1. Class A and Class D are classified according to section 5 of IEC 61000-3-2: 2005/ EN 61000-3-2:2006.
2. According to section 7 of IEC 61000-3-2: 2005/ EN 61000-3-2: 2006, the above limits for all equipment except for lighting equipment are for all applications having an active input power > 75 W and no limits apply for equipment with an active input power up to and including 75 W.

#### 4.3.2 TEST INSTRUMENTS

DESCRIPTION & MANUFACTURER	MODEL NO.	SERIAL NO.	CALIBRATED DATE	CALIBRATED UNTIL
EMC PARTNER EMC Emission Tester	HAR1000-1P	084	Apr. 12, 2011	Apr. 11, 2012
Software	HARCS	NA	NA	NA

- NOTE:** 1. The test was performed in EMS Room No. 1.
2. The calibration interval of the above test instruments is 12 months and the calibrations are traceable to NML/ROC and NIST/USA.
3. According to IEC 61000-4-7: 2002, the time window shall be synchronized with each group of 10 or 12 cycles (200 ms) for power frequency of 50 or 60Hz.

### 4.3.3 TEST PROCEDURE

- a. The EUT was placed on the top of a wooden table 0.8 meters above the ground and operated to produce the maximum harmonic components under normal operating conditions for each successive harmonic component in turn.
- b. The classification of EUT is according to section 5 of IEC 61000-3-2: 2005/ EN 61000-3-2: 2006.

The EUT is classified as follows:

Class A: Balanced three-phase equipment, Household appliances excluding equipment as Class D, Tools excluding portable tools, Dimmers for incandescent lamps, audio equipment, equipment not specified in one of the three other classes.

Class B: Portable tools. ; Arc welding equipment which is not professional equipment

Class C: Lighting equipment.

Class D: Equipment having a specified power less than or equal to 600 W of the following types: Personal computers and personal computer monitors and television receivers.

- c. The correspondent test program of test instrument to measure the current harmonics emanated from EUT is chosen. The measure time shall be not less than the time necessary for the EUT to be exercised.

### 4.3.4 DEVIATION FROM TEST STANDARD

No deviation

### 4.3.5 TEST SETUP

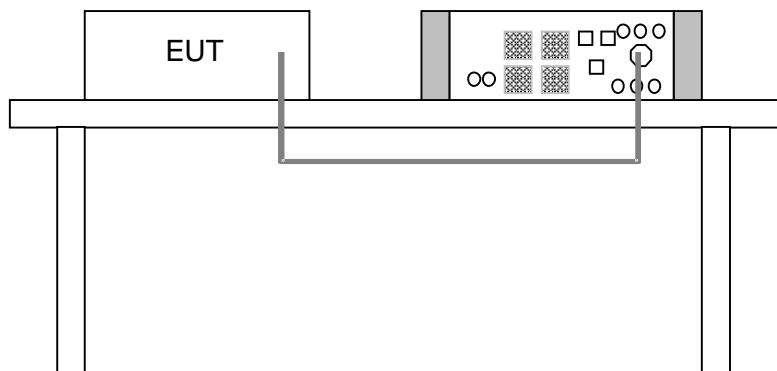

For the actual test configuration, please refer to the related item – Photographs of the Test Configuration.

### 4.3.6 EUT OPERATING CONDITIONS

Connected resistor load to DC output port of EUT to make EUT have maximum power consumption.



A D T

### 4.3.7 TEST RESULTS

<b>TEST MODE</b>	Mode 1		
<b>FUNDAMENTAL VOLTAGE/AMPERE</b>	230.3Vrms/ 0.469Arms	<b>POWER FREQUENCY</b>	49.987Hz
<b>POWER CONSUMPTION</b>	42.70W	<b>POWER FACTOR</b>	0.396
<b>ENVIRONMENTAL CONDITIONS</b>	26deg. C, 70% RH	<b>TESTED BY:</b> Ted Huang	

**NOTE:** Limits are not specified for equipment with a rated power of 75W or less (other than lighting equipment).



## 4.4 VOLTAGE FLUCTUATION AND FLICKS MEASUREMENT

### 4.4.1 LIMITS OF VOLTAGE FLUCTUATION AND FLICKS MEASUREMENT

TEST STANDARD: IEC 61000-3-3 / EN 61000-3-3

TEST ITEM	LIMIT	NOTE
$P_{st}$	1.0	$P_{st}$ means short-term flicker indicator.
$P_{lt}$	0.65	$P_{lt}$ means long-term flicker indicator.
$T_{d(t)}$ (ms)	500	$T_{d(t)}$ means maximum time that $d(t)$ exceeds 3.3%.
$d_{max}$ (%)	4	$d_{max}$ means maximum relative voltage change.
dc (%)	3.3	dc means relative steady-state voltage change

### 4.4.2 TEST INSTRUMENTS

DESCRIPTION & MANUFACTURER	MODEL NO.	SERIAL NO.	CALIBRATED DATE	CALIBRATED UNTIL
EMC PARTNER EMC Emission Tester	HAR1000-1P	084	Apr. 12, 2011	Apr. 11, 2012
Software	HARCS	NA	NA	NA

**NOTE:** 1. The test was performed in EMS Room No. 1.  
2. The calibration interval of the above test instruments is 12 months and the calibrations are traceable to NML/ROC and NIST/USA.

### 4.4.3 TEST PROCEDURE

- a. The EUT was placed on the top of a wooden table 0.8 meters above the ground and operated to produce the most unfavorable sequence of voltage changes under normal operating conditions.
- b. During the flick measurement, the measure time shall include that part of whole operation cycle in which the EUT produce the most unfavorable sequence of voltage changes. The observation period for short-term flicker indicator is 10 minutes and the observation period for long-term flicker indicator is 2 hours.

### 4.4.4 DEVIATION FROM TEST STANDARD

No deviation

#### 4.4.5 TEST SETUP

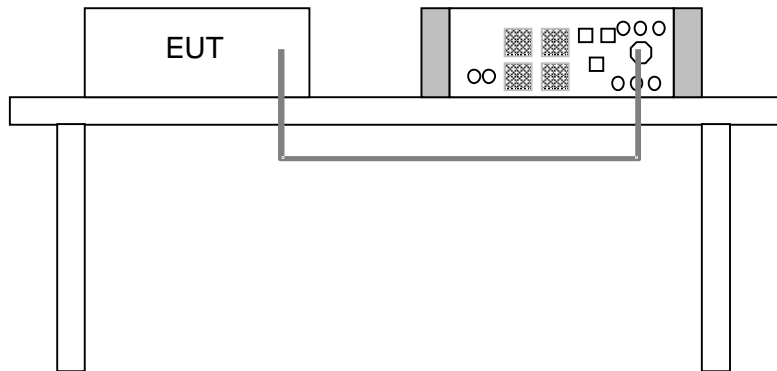

For the actual test configuration, please refer to the related item – Photographs of the Test Configuration.

#### 4.4.6 EUT OPERATING CONDITIONS

Same as item 4.3.6

#### 4.4.7 TEST RESULTS

<b>TEST MODE</b>	Mode 1		
<b>FUNDAMENTAL VOLTAGE/AMPERE</b>	230.3Vrms/ 0.469Arms	<b>POWER FREQUENCY</b>	49.987Hz
<b>OBSERVATOPM PERIOD (Tp)</b>	10 min	<b>POWER FACTOR</b>	0.396
<b>ENVIRONMENTAL CONDITIONS</b>	26deg. C, 70% RH	<b>TESTED BY:</b> Ted Huang	

<b>TEST PARAMETER</b>	<b>MEASUREMENT VALUE</b>	<b>LIMIT</b>	<b>REMARKS</b>
P <sub>st</sub>	0.072	1.0	Pass
P <sub>lt</sub>	0.072	0.65	Pass
T <sub>d(t)</sub> (ms)	0	500	Pass
d <sub>max</sub> (%)	0	4	Pass
dc (%)	0.040	3.3	Pass

- NOTE:**
- (1) P<sub>st</sub> means short-term flicker indicator.
  - (2) P<sub>lt</sub> means long-term flicker indicator.
  - (3) T<sub>d(t)</sub> means maximum time that d(t) exceeds 3.3%.
  - (4) d<sub>max</sub> means maximum relative voltage change.
  - (5) dc means relative steady-state voltage change.

## 5 IMMUNITY TEST

### 5.1 GENERAL DESCRIPTION

<b>Product Standard:</b>	<b>EN 61204-3: 2000</b>	
<b>Basic Standard, specification requirement, and Performance Criteria:</b>	IEC 61000-4-2	Electrostatic Discharge – ESD: 8kV air discharge, 4kV Contact discharge, Performance Criterion B
	IEC 61000-4-3	Radio-Frequency Electromagnetic Field Amplitude modulated – RS: 80-1000 MHz, 3V/m, 80% AM (1kHz), Performance Criterion B
		Radio-Frequency Electromagnetic Field, Keyed carrier: 900+/-5 MHz, 3V/m, 50 % duty cycle, Rep. Frequency 200 Hz, Performance Criterion B
	IEC 61000-4-4	Electrical Fast Transient/Burst - EFT, Power line: 1kV, Signal line: 0.5kV, Performance Criterion B
	IEC 61000-4-5	Surge Immunity Test: 1.2/50 us Open Circuit Voltage, 8 /20 us Short Circuit Current, line to line: 1kV, line to earth: 2kV, Performance Criterion B
	IEC 61000-4-6	Conducted Radio Frequency Disturbances Test – CS: 0.15-80 MHz, 3Vrms, 80% AM, 1kHz, Performance Criterion B
	IEC 61000-4-11	Voltage Dips: i) 30% reduction – 10ms, Performance Criterion B ii) 60% reduction – 100ms, Performance Criterion C
Voltage Interruptions: i) >95% reduction – 5000ms, Performance Criterion C		



<b>Product Standard:</b>	<b>EN 55024:1998+A1:2001+A2: 2003</b>	
<b>Basic Standard, specification requirement, and Performance Criteria:</b>	IEC 61000-4-2	Electrostatic Discharge – ESD: 8kV air discharge, 4kV Contact discharge, Performance Criterion B
	IEC 61000-4-3	Radio-Frequency Electromagnetic Field Susceptibility Test – RS: 80-1000 MHz, 3V/m, 80% AM (1kHz), Performance Criterion A
	IEC 61000-4-4	Electrical Fast Transient/Burst - EFT AC Power line: 1kV, DC Power line: 0.5kV Signal line: 0.5kV Performance Criterion B
	IEC 61000-4-5	Surge Immunity Test: 1.2/50 us Open Circuit Voltage, 8 /20 us Short Circuit Current AC Power Line: line to line 1 kV, line to earth 2kV DC Power Line: line to earth 0.5kV Signal line: 1kV Performance Criterion B
	IEC 61000-4-6	Conducted Radio Frequency Disturbances Test – CS: 0.15-80 MHz, 3V, 80% AM, 1kHz, Performance Criterion A
	IEC 61000-4-8	Power Frequency Magnetic Field Test, 50 Hz, 1A/m, Performance Criterion A
	IEC 61000-4-11	Voltage Dips: i) >95% reduction -0.5 period, Performance Criterion B ii) 30% reduction – 25 period, Performance Criterion C Voltage Interruptions: i). >95% reduction – 250 period, Performance Criterion C

## 5.2 GENERAL PERFORMANCE CRITERIA DESCRIPTION

According to Clause 6.1 of EN 61204-3: 2000 standard, the following describes the general performance criteria.

<b>Performance Criteria</b>	Basic specifications	Remarks
<b>A</b>	No loss of function or performance during the test	Operating as intended within specified tolerance
<b>B</b>	Temporary loss of function or performance during the test Self recoverable	Degradation of performance shall be specified by the manufacturer PSU shall continue to operate as intended after the test
<b>C</b>	Loss of function or performance Not self-recoverable Not damaged	Any re-settable condition allowed including shut-down

According to EN 55024: 1998 +A1: 2001+A2: 2003 standard, the following describes the general performance criteria.

<b>CRITERION A</b>	The equipment shall continue to operate as intended without operator intervention. No degradation of performance or loss of function is allowed below a performance level specified by the manufacturer when the equipment is used as intended. The performance level may be replaced by a permissible loss of performance. If the minimum performance level or the permissible performance loss is not specified by the manufacturer, then either of these may be derived from the product description and documentation, and by what the user may reasonably expect from the equipment if used as intended.
<b>CRITERION B</b>	<p>After the test, the equipment shall continue to operate as intended without operator intervention. No degradation of performance or loss of function is allowed, after the application of the phenomenon below a performance level specified by the manufacturer, when the equipment is used as intended. The performance level may be replaced by a permissible loss of performance.</p> <p>During the test, degradation of performance is allowed. However, no change of operating state if stored data is allowed to persist after the test. If the minimum performance level (or the permissible performance loss) is not specified by the manufacturer, then either of these may be derived from the product description and documentation, and by what the user may reasonably expect from the equipment if used as intended.</p>
<b>CRITERION C</b>	<p>Loss of function is allowed, provided the function is self-recoverable, or can be restored by the operation of the controls by the user in accordance with the manufacturer's instructions.</p> <p>Functions, and/or information stored in non-volatile memory, or protected by a battery backup, shall not be lost.</p>

### 5.3 EUT OPERATING CONDITION

Connected a resistor load to DC output port of EUT to make EUT have maximum power consumption and a multimeter was used to monitor voltage of output.

## 5.4 ELECTROSTATIC DISCHARGE IMMUNITY TEST (ESD)

### 5.4.1 TEST SPECIFICATION

<b>Basic Standard:</b>	IEC 61000-4-2
<b>Discharge Impedance:</b>	330 ohm / 150 pF
<b>Discharge Voltage:</b>	Air Discharge: 2kV/ 4kV/ 8kV (Direct) Contact Discharge: 2kV/ 4kV (Indirect)
<b>Polarity:</b>	Positive & Negative
<b>Number of Discharge:</b>	<b>For EN 55024:</b> Air Discharge: min. 20 times at each test point Contact Discharge: min. 200 times in total <b>For EN 61204-3:</b> 20 times at each test point
<b>Discharge Mode:</b>	Single Discharge
<b>Discharge Period:</b>	1 second minimum

### 5.4.2 TEST INSTRUMENTS

DESCRIPTION & MANUFACTURER	MODEL NO.	SERIAL NO.	CALIBRATED DATE	CALIBRATED UNTIL
KeyTek, ESD Simulator	MZ-15/EC	0401299	May. 18, 2011	May. 17, 2012

- NOTE:** 1. The test was performed in ESD Room No. 3.  
2. The calibration interval of the above test instruments is 12 months and the calibrations are traceable to NML/ROC and NIST/USA.

### 5.4.3 TEST PROCEDURE

The discharges shall be applied in two ways: **<For EN 55024>**

- a. Contact discharges to the conductive surfaces and coupling planes:

The EUT shall be exposed to at least 200 discharges, 100 each at negative and positive polarity, at a minimum of four test points. One of the test points shall be subjected to at least 50 indirect discharges to the center of the front edge of the horizontal coupling plane. The remaining three test points shall each receive at least 50 direct contact discharges. If no direct contact test points are available, then at least 200 indirect discharges shall be applied in the indirect mode. Test shall be performed at a maximum repetition rate of one discharge per second.

- b. Air discharges at slots and apertures and insulating surfaces:

On those parts of the EUT where it is not possible to perform contact discharge testing, the equipment should be investigated to identify user accessible points where breakdown may occur. Such points are tested using the air discharge method. This investigation should be restricted to those area normally handled by the user. A minimum of 10 single air discharges shall be applied to the selected test point for each such area.



The basic test procedure was in accordance with **IEC 61000-4-2**:

- a. Electrostatic discharges were applied only to those points and surfaces of the EUT that are accessible to users during normal operation.
- b. The test was performed with at least ten single discharges on the pre-selected points in the most sensitive polarity.
- c. The time interval between two successive single discharges was at least 1 second.
- d. The ESD generator was held perpendicularly to the surface to which the discharge was applied and the return cable was at least 0.2 meters from the EUT.
- e. Contact discharges were applied to the non-insulating coating, with the pointed tip of the generator penetrating the coating and contacting the conducting substrate.
- f. Air discharges were applied with the round discharge tip of the discharge electrode approaching the EUT as fast as possible (without causing mechanical damage) to touch the EUT. After each discharge, the ESD generator was removed from the EUT and re-triggered for a new single discharge. The test was repeated until all discharges were complete.
- g. At least ten single discharges (in the most sensitive polarity) were applied to the **Horizontal Coupling Plane** at points on each side of the EUT. The ESD generator was positioned horizontally at a distance of 0.1 meters from the EUT with the discharge electrode touching the **HCP**.
- h. At least ten single discharges (in the most sensitive polarity) were applied to the center of one vertical edge of the **Vertical Coupling Plane** in sufficiently different positions that the four faces of the EUT were completely illuminated. The **VCP** (dimensions 0.5m x 0.5m) was placed vertically to and 0.1 meters from the EUT.

#### 5.4.4 DEVIATION FROM TEST STANDARD

No deviation

### 5.4.5 TEST SETUP

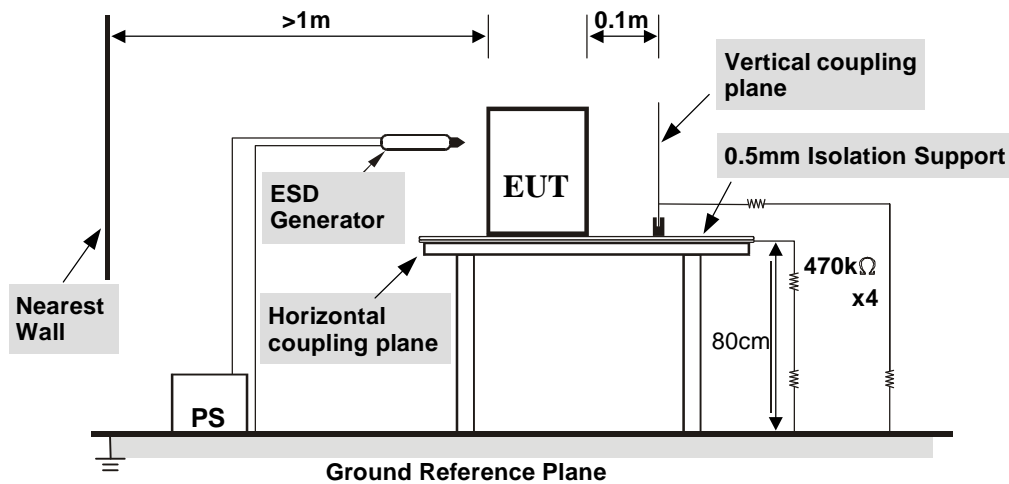

For the actual test configuration, please refer to the related item – Photographs of the Test Configuration.

**NOTE:**

TABLE-TOP EQUIPMENT

The configuration consisted of a wooden table 0.8 meters high standing on the **Ground Reference Plane**. The **GRP** consisted of a sheet of aluminum at least 0.25mm thick, and 2.5 meters square connected to the protective grounding system. A **Horizontal Coupling Plane** (1.6m x 0.8m) was placed on the table and attached to the **GRP** by means of a cable with 940kΩ total impedance. The equipment under test, was installed in a representative system as described in section 7 of IEC 61000-4-2, and its cables were placed on the **HCP** and isolated by an insulating support of 0.5mm thickness. A distance of 1-meter minimum was provided between the EUT and the walls of the laboratory and any other metallic structure.

FLOOR-STANDING EQUIPMENT

The equipment under test was installed in a representative system as described in section 7 of IEC 61000-4-2, and its cables were isolated from the Ground Reference Plane by an insulating support of 0.1-meter thickness. The GRP consisted of a sheet of aluminum that is at least 0.25mm thick, and 2.5 meters square connected to the protective grounding system and extended at least 0.5 meters from the EUT on all sides.

### 5.4.6 TEST RESULTS

<b>TEST MODE</b>	Mode 1	<b>INPUT POWER</b>	230Vac, 50 Hz
<b>ENVIRONMENTAL CONDITIONS</b>	24deg. C, 43% RH, 1009hPa	<b>TESTED BY:</b> Aga Lin	

TEST RESULTS OF DIRECT APPLICATION					
Discharge Level (kV)	Polarity	Test Point	Contact Discharge	Air Discharge	Performance Criterion
2, 4, 8	+/-	1 ~ 5	N/A	Note	A

**Description of test point:** Please refer to ESD test photo for representative mark only.

TEST RESULTS OF INDIRECT APPLICATION					
Discharge Level (kV)	Polarity	Test Point	Horizontal Coupling Plane	Vertical Coupling Plane	Performance Criterion
2, 4	+/-	1 ~ 4	Note	Note	A

**Description of test point:**

1. Left side
2. Right side
3. Front side
4. Rear side

**NOTE:** There was no change compared with initial operation during the test.

## 5.5 RADIATED, RADIO-FREQUENCY, ELECTROMAGNETIC FIELD IMMUNITY TEST (RS)

### 5.5.1 TEST SPECIFICATION

<b>Basic Standard:</b>	IEC 61000-4-3
<b>Frequency Range:</b>	80 MHz - 1000 MHz
<b>Field Strength:</b>	3 V/m
<b>Modulation:</b>	1 kHz Sine Wave, 80%, AM Modulation
<b>Frequency Step:</b>	1 % of fundamental
<b>Polarity of Antenna:</b>	Horizontal and Vertical
<b>Antenna Height:</b>	1.5 m
<b>Dwell Time:</b>	3 seconds

## 5.5.2 TEST INSTRUMENTS

DESCRIPTION & MANUFACTURER	MODEL NO.	SERIAL NO.	CALIBRATED DATE	CALIBRATED UNTIL
R&S Signal Generator	SML03	101801	Dec. 23, 2010	Dec. 22, 2011
AR RF Amplifier	60S1G3	304334	NA	NA
BOONTON RF Meter	4232A	94901	Jun. 29, 2011	Jun. 28, 2012
BOONTON Power Sensor	51011-EMC	32832	Jun. 29, 2011	Jun. 28, 2012
BOONTON Power Sensor	51011-EMC	32807	Jun. 29, 2011	Jun. 28, 2012
Radisense Electric Field Sensor	CTR1001A RadiSense 6	06D00232SNO-02 06D00232SNO39	Jul. 15, 2011	Jul. 14, 2012
FRANKONIA Power Amplifier	FLH-200B	1071	NA	NA
Dell Antenna	NA	NA	NA	NA
AR Log-Periodic Antenna	AT5080	312115	NA	NA
HP-IB Extender	37204	3212U26684	NA	NA
ADVANTEST Spectrum Analyzer	R3261C	81720152	NA	NA
COMTEST Compact Full Anechoic Chamber (7x3x3 m)	CFAC	RS-001	Oct. 02, 2010	Oct. 01, 2011
Software	ADT_RS_V7.6	NA	NA	NA

- NOTE:**
1. The test was performed in RS Room No.1.
  2. The calibration interval of the above test instruments is 12 months and the calibrations are traceable to NML/ROC and NIST/USA.
  3. The transmit antenna was located at a distance of 3 meters from the EUT.

### 5.5.3 TEST PROCEDURE

The test procedure was in accordance with IEC 61000-4-3

- a. The testing was performed in a fully-anechoic chamber.
- b. The frequency range is swept from 80 MHz to 1000 MHz with the signal 80% amplitude modulated with a 1kHz sine wave.
- c. The dwell time at each frequency shall not be less than the time necessary for the EUT to be exercised and to respond, but shall in no case be less than 0,5s.
- d. The field strength level was 3V/m.
- e. The test was performed with the EUT exposed to both vertically and horizontally polarized fields on each of the four sides.

### 5.5.4 DEVIATION FROM TEST STANDARD

No deviation

### 5.5.5 TEST SETUP

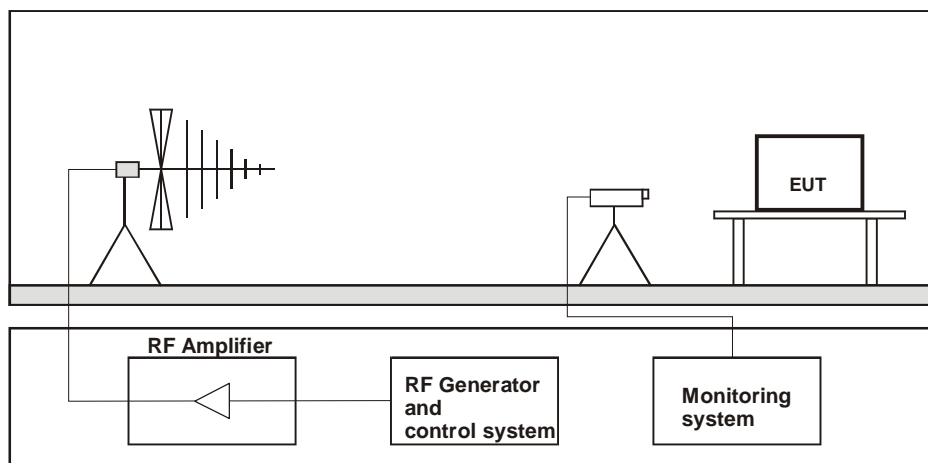

For the actual test configuration, please refer to the related item – Photographs of the Test Configuration.

#### NOTE:

##### TABLETOP EQUIPMENT

The EUT installed in a representative system as described in section 7 of IEC 61000-4-3 was placed on a non-conductive table 0.8 meters in height. The system under test was connected to the power and signal wire according to relevant installation instructions.

##### FLOOR STANDING EQUIPMENT

The EUT installed in a representative system as described in section 7 of IEC 61000-4-3 was placed on a non-conductive wood support 0.1 meters in height. The system under test was connected to the power and signal wire according to relevant installation instructions.

### 5.5.6 TEST RESULTS

<b>TEST MODE</b>	Mode 1	<b>INPUT POWER</b>	230Vac, 50 Hz
<b>ENVIRONMENTAL CONDITIONS</b>	25deg. C, 63%RH	<b>TESTED BY:</b> Thomas Cheng	

Frequency (MHz)	Polarity	Azimuth	Field Strength (V/m)	Observation	Performance Criterion
80 – 1000	V&H	0	3	Note	A
	V&H	90	3		
	V&H	180	3		
	V&H	270	3		

**NOTE:** There was no change compared with initial operation during the test.

## 5.6 RADIO-FREQUENCY ELECTROMAGNETIC FIELD – KEYED CARRIER TEST

### 5.6.1 TEST SPECIFICATION

<b>Basic Standard:</b>	IEC 61000-4-3
<b>Frequency Range:</b>	895 MHz - 905 MHz
<b>Field Strength:</b>	3 V/m
<b>Modulation:</b>	Pulse 200 Hz, 50% Duty Cycle
<b>Frequency Step:</b>	1 MHz
<b>Polarity of Antenna:</b>	Horizontal and Vertical
<b>Antenna Height:</b>	1.5 m
<b>Dwell Time:</b>	3 seconds



## 5.6.2 TEST INSTRUMENTS

DESCRIPTION & MANUFACTURER	MODEL NO.	SERIAL NO.	CALIBRATED DATE	CALIBRATED UNTIL
R&S Signal Generator	SML03	101801	Dec. 23, 2010	Dec. 22, 2011
AR RF Amplifier	60S1G3	304334	NA	NA
BOONTON RF Meter	4232A	94901	Jun. 29, 2011	Jun. 28, 2012
BOONTON Power Sensor	51011-EMC	32832	Jun. 29, 2011	Jun. 28, 2012
BOONTON Power Sensor	51011-EMC	32807	Jun. 29, 2011	Jun. 28, 2012
Radisense Electric Field Sensor	CTR1001A RadiSense 6	06D00232SNO-02 06D00232SNO39	Jul. 15, 2011	Jul. 14, 2012
FRANKONIA Power Amplifier	FLH-200B	1071	NA	NA
Dell Antenna	NA	NA	NA	NA
AR Log-Periodic Antenna	AT5080	312115	NA	NA
HP-IB Extender	37204	3212U26684	NA	NA
ADVANTEST Spectrum Analyzer	R3261C	81720152	NA	NA
COMTEST Compact Full Anechoic Chamber (7x3x3 m)	CFAC	RS-001	Oct. 02, 2010	Oct. 01, 2011
Software	ADT_RS_V7.6	NA	NA	NA

- NOTE:**
1. The test was performed in RS Room No.1.
  2. The calibration interval of the above test instruments is 12 months and the calibrations are traceable to NML/ROC and NIST/USA.
  3. The transmit antenna was located at a distance of 3 meters from the EUT.

### 5.6.3 TEST PROCEDURE

The test procedure was in accordance with IEC 61000-4-3

- a. The testing was performed in a fully-anechoic chamber.
- b. The frequency range was from 895 MHz to 905 MHz. The test spot frequencies with keying capability were at 200 Hz, 50 % duty cycle.
- c. The dwell time at each frequency shall be not less than the time necessary for the EUT to be able to respond, but shall in no case be less than 0,5s.
- d. The field strength level was 3V/m.
- e. The test was performed with the EUT exposed to both vertically and horizontally polarized fields on each of the four sides.

### 5.6.4 DEVIATION FROM TEST STANDARD

No deviation

### 5.6.5 TEST SETUP

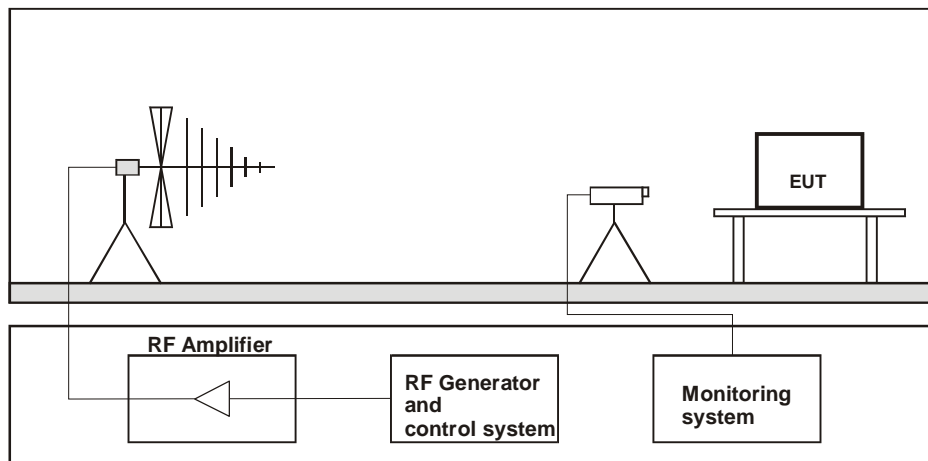

For the actual test configuration, please refer to the related item – Photographs of the Test Configuration.

#### **NOTE:**

##### TABLETOP EQUIPMENT

The EUT installed in a representative system as described in section 7 of IEC 61000-4-3 was placed on a non-conductive table 0.8 meters in height. The system under test was connected to the power and signal wire according to relevant installation instructions.

##### FLOOR STANDING EQUIPMENT

The EUT installed in a representative system as described in section 7 of IEC 61000-4-3 was placed on a non-conductive wood support 0.1 meters in height. The system under test was connected to the power and signal wire according to relevant installation instructions.

### 5.6.6 TEST RESULTS

<b>TEST MODE</b>	Mode 1	<b>INPUT POWER</b>	230Vac, 50 Hz
<b>ENVIRONMENTAL CONDITIONS</b>	25deg. C, 63%RH	<b>TESTED BY:</b> Thomas Cheng	

Frequency (MHz)	Polarity	Azimuth	Field Strength (V/m)	Observation	Performance Criterion
895 -905	V & H	0	3	Note	A
	V & H	90	3	Note	A
	V & H	180	3	Note	A
	V & H	270	3	Note	A

**NOTE:** There was no change compared with initial operation during the test.

## 5.7 ELECTRICAL FAST TRANSIENT/BURST IMMUNITY TEST (EFT)

### 5.7.1 TEST SPECIFICATION

<b>Basic Standard:</b>	IEC 61000-4-4
<b>Test Voltage:</b>	Power Line: 1 kV Signal/Control Line: N/A
<b>Polarity:</b>	Positive & Negative
<b>Impulse Frequency:</b>	5 kHz
<b>Impulse Waveshape:</b>	5/50 ns
<b>Burst Duration:</b>	15 ms
<b>Burst Period:</b>	300 ms
<b>Test Duration:</b>	1 min.

### 5.7.2 TEST INSTRUMENTS

DESCRIPTION & MANUFACTURER	MODEL NO.	SERIAL NO.	CALIBRATED DATE	CALIBRATED UNTIL
Haefely, EFT Generator	PEFT 4010	154954	Apr. 19, 2011	Apr. 18, 2012
Haefely, Capacitive Clamp	IP4A	155173	NA	NA

- NOTE:** 1. The test was performed in EFT Room  
 2. The calibration interval of the above test instruments is 12 months and the calibrations are traceable to NML/ROC and NIST/USA.

### 5.7.3 TEST PROEDURE

- Both positive and negative polarity discharges were applied.
- The length of the “hot wire” from the coaxial output of the EFT generator to the terminals on the EUT should not exceed 0.5 meter  $\pm$  0.05 meter.
- The duration time of each test sequential was 1 minute.
- The transient/burst waveform was in accordance with IEC 61000-4-4, 5/50ns.

### 5.7.4 DEVIATION FROM TEST STANDARD

No deviation

## 5.7.5 TEST SETUP

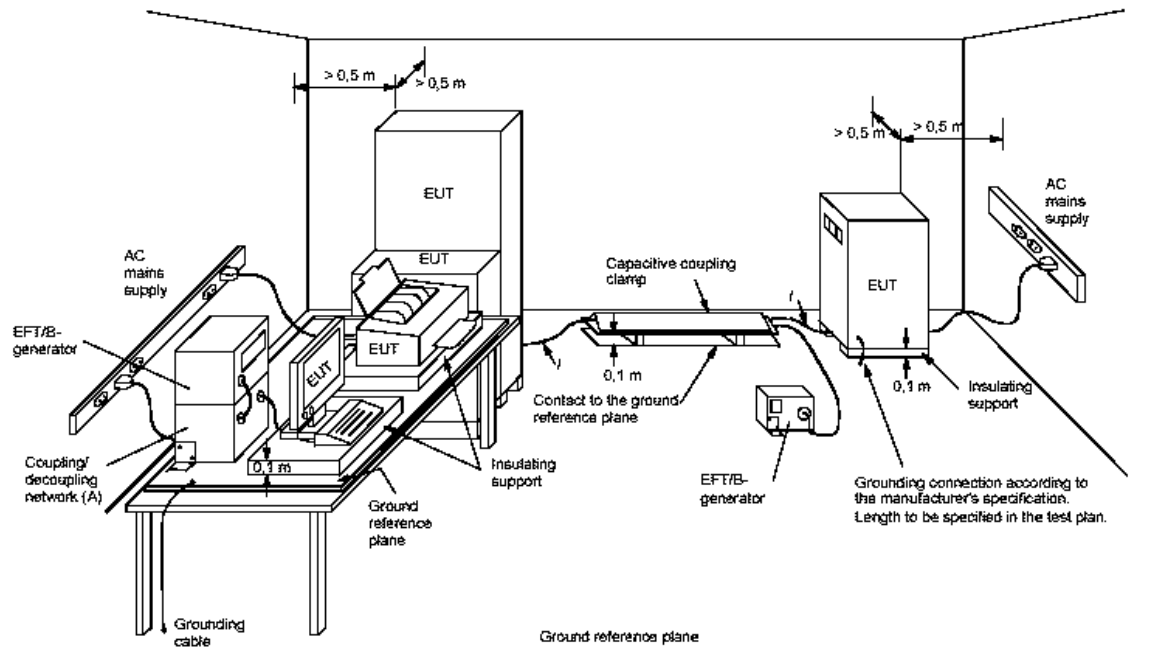

For the actual test configuration, please refer to the related item – Photographs of the Test Configuration.

### **NOTE:**

#### **TABLETOP EQUIPMENT**

The configuration consisted of a wooden table standing on the Ground Reference Plane and should be located 0.1m +/- 0.01m above the Ground Reference Plane.

The GRP consisted of a sheet of aluminum (at least 0.25mm thick and 2.5m square) connected to the protective grounding system. A minimum distance of 0.5m was provided between the EUT and the walls of the laboratory or any other metallic structure.

#### **FLOOR STANDING EQUIPMENT**

The EUT installed in a representative system as described in section 7 of IEC 61000-4-4 and its cables, were isolated from the Ground Reference Plane by an insulating support that is 0.1-meter thick. The GRP consisted of a sheet of aluminum (at least 0.25mm thick and 2.5m square) connected to the protective grounding system.

### 5.7.6 TEST RESULTS

<b>TEST MODE</b>	Mode 1	<b>INPUT POWER</b>	230Vac, 50 Hz
<b>ENVIRONMENTAL CONDITIONS</b>	27deg. C, 67%RH	<b>TESTED BY:</b> Ted Huang	

Test Point	Polarity	Test Level (kV)	Observation	Performance Criterion
L1	+/-	1	Note	A
L2	+/-	1	Note	A
L1-L2	+/-	1	Note	A

**NOTE:** There was no change compared with initial operation during the test.

## 5.8 SURGE IMMUNITY TEST

### 5.8.1 TEST SPECIFICATION

<b>Basic Standard:</b>	IEC 61000-4-5
<b>Wave-Shape:</b>	Combination Wave 1.2/50 us Open Circuit Voltage 8 /20 us Short Circuit Current
<b>Test Voltage:</b>	Power Line: 0.5kV/ 1kV
<b>Surge Input/ Output:</b>	L1-L2
<b>Generator Source</b>	2 ohm between networks
<b>Impedance:</b>	12 ohm between network and ground
<b>Polarity:</b>	Positive/Negative
<b>Phase Angle:</b>	0° /90°/180°/270°
<b>Pulse Repetition Rate:</b>	1 time / 20 sec.
<b>Number of Tests:</b>	5 positive and 5 negative at selected points

### 5.8.2 TEST INSTRUMENTS

DESCRIPTION & MANUFACTURER	MODEL NO.	SERIAL NO.	CALIBRATED DATE	CALIBRATED UNTIL
NoiseKen Surge Generator	LSS-15AX-C3 A	LSS1071126	Oct. 28, 2010	Oct. 27, 2011
Coupling Decoupling Network	CDN-UTP8	028	Jul. 18, 2011	Jul. 17, 2012
Surge Cable	WE-4	SU1Cab-001	NA	NA
Surge Adapter WONPRO	WA-9	SU1ADA-002	NA	NA

- NOTE:** 1. The test was performed in Surge Room.  
2. The calibration interval of the above test instruments is 12 months and the calibrations are traceable to NML/ROC and NIST/USA.

### 5.8.3 TEST PROCEDURE

a. For EUT power supply:

The surge is to be applied to the EUT power supply terminals via the capacitive coupling network. Decoupling networks are required in order to avoid possible adverse effects on equipment not under test that may be powered by the same lines, and to provide sufficient decoupling impedance to the surge wave. The power cord between the EUT and the coupling/decoupling networks shall be 2 meters in length (or shorter).

b. For test applied to unshielded unsymmetrically operated interconnection lines of EUT:

The surge is applied to the lines via the capacitive coupling. The coupling / decoupling networks shall not influence the specified functional conditions of the EUT. The interconnection line between the EUT and the coupling/decoupling networks shall be 2 meters in length (or shorter).

c. For test applied to unshielded symmetrically operated interconnection / telecommunication lines of EUT:

The surge is applied to the lines via gas arrestors coupling. Test levels below the ignition point of the coupling arrestor cannot be specified. The interconnection line between the EUT and the coupling/decoupling networks shall be 2 meters in length (or shorter).

### 5.8.4 DEVIATION FROM TEST STANDARD

No deviation

### 5.8.5 TEST SETUP

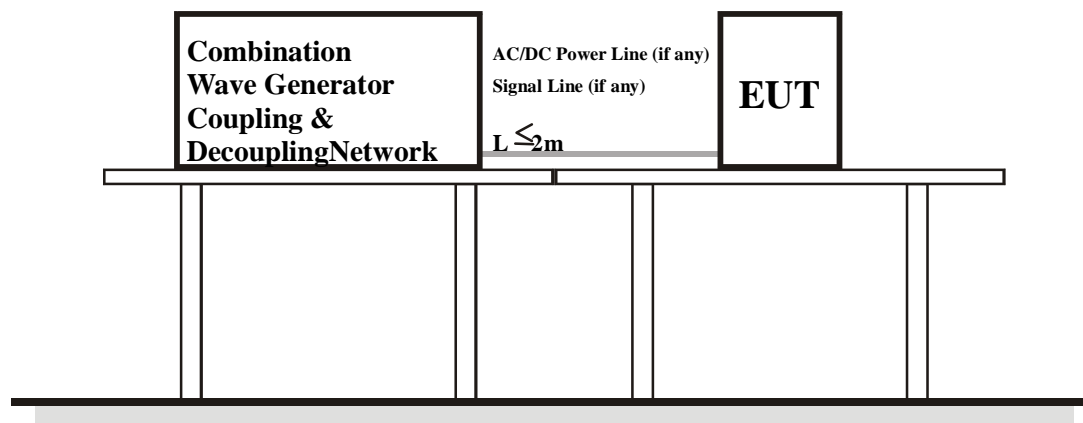

For the actual test configuration, please refer to the related item – Photographs of the Test Configuration.



### 5.8.6 TEST RESULTS

<b>TEST MODE</b>	Mode 1	<b>INPUT POWER</b>	230Vac, 50 Hz
<b>ENVIRONMENTAL CONDITIONS</b>	27deg. C, 65%RH	<b>TESTED BY:</b> Ted Huang	

<b>VOLTAGE (kV)</b>	<b>TEST POINT</b>	<b>POLARITY</b>	<b>OBSERVATION</b>	<b>PERFORMANCE CRITERION</b>
0.5, 1	L1-L2	+/-	Note	A

**NOTE:** There was no change compared with the initial operation during the test.

## 5.9 IMMUNITY TO CONDUCTED DISTURBANCES INDUCED BY RF FIELDS (CS)

### 5.9.1 TEST SPECIFICATION

<b>Basic Standard:</b>	IEC 61000-4-6
<b>Frequency Range:</b>	0.15 MHz - 80 MHz
<b>Field Strength:</b>	3 V <sub>r.m.s.</sub>
<b>Modulation:</b>	1 kHz Sine Wave, 80%, AM Modulation
<b>Frequency Step:</b>	1 % of fundamental
<b>Coupled Cable:</b>	Power Mains
<b>Coupling Device:</b>	CDN-M2 (2 wires)



A D T

## 5.9.2 TEST INSTRUMENTS

DESCRIPTION & MANUFACTURER	MODEL NO.	SERIAL NO.	CALIBRATED DATE	CALIBRATED UNTIL
ROHDE & SCHWARZ Signal Generator	SMY01	841104/033	Nov. 23, 2010	Nov. 22, 2011
Digital Sweep Function Generator	8120	984801	NA	NA
AR Power Amplifier	75A250AM1	312196	NA	NA
FCC Coupling Decoupling Network	FCC-801-M3-25A	48	Jul. 14, 2011	Jul. 13, 2012
FCC Coupling Decoupling Network	FCC-801-M3-25A	01022	Feb. 25, 2011	Feb. 24, 2012
FCC Coupling Decoupling Network	FCC-801-M2-16A	01047	Jul. 14, 2011	Jul. 13, 2012
FISCHER CUSTOM COMMUNICATIONS EM Injection Clamp	FCC-203I	50	NA	NA
FISCHER CUSTOM COMMUNICATIONS Current Injection Clamp	F-120-9A	361	NA	NA
EM TEST Coupling Decoupling Network	CDN M1/32A	306508	Feb. 25, 2011	Feb. 24, 2012
FCC Coupling Decoupling Network	FCC-801-T8	02038	Feb. 25, 2011	Feb. 24, 2012
FCC Coupling Decoupling Network	FCC-801-T4	02031	Feb. 25, 2011	Feb. 24, 2012
FCC Coupling Decoupling Network	FCC-801-T2	02021	Feb. 25, 2011	Feb. 24, 2012
R&S Power Sensor	NRV-Z5	837878/038	Nov. 01, 2010	Oct. 31, 2011
R&S Power Sensor	NRV-Z5	837878/039	Nov. 01, 2010	Oct. 31, 2011
R&S Power Meter	NRVD	837794/040	Nov. 01, 2010	Oct. 31, 2011
Software	ADT_CS_V7.4.2	NA	NA	NA

- NOTE:** 1. The test was performed in CS Room No. 1.  
2. The calibration interval of the above test instruments is 12 months and the calibrations are traceable to NML/ROC and NIST/USA.

### 5.9.3 TEST PROCEDURE

- a. The EUT shall be tested within its intended operating and climatic conditions.
- b. An artificial hand was placed on the hand-held accessory and connected to the ground reference plane.
- c. One of the CDNs not used for injection was terminated with  $50\Omega$ , providing only one return path. All other CDNs were coupled as decoupling networks.
- d. The frequency range is swept from 150 kHz to 80 MHz, using the signal level established during the setting process and with a disturbance signal of 80 % amplitude. The signal is modulated with a 1 kHz sine wave, pausing to adjust the RF signal level or the switch coupling devices as necessary. Where the frequency is swept incrementally, the step size shall not exceed 1 % of the preceding frequency value.
- e. The dwell time of the amplitude modulated carrier at each frequency shall not be less than the time necessary for the EUT to be exercised and to respond, but shall in no case be less than 0,5 s. The sensitive frequencies (e.g. clock frequencies) shall be analyzed separately.
- f. Attempts should be made to fully exercise the EUT during testing, and to fully interrogate all exercise modes selected for susceptibility.

### 5.9.4 DEVIATION FROM TEST STANDARD

No deviation

### 5.9.5 TEST SETUP

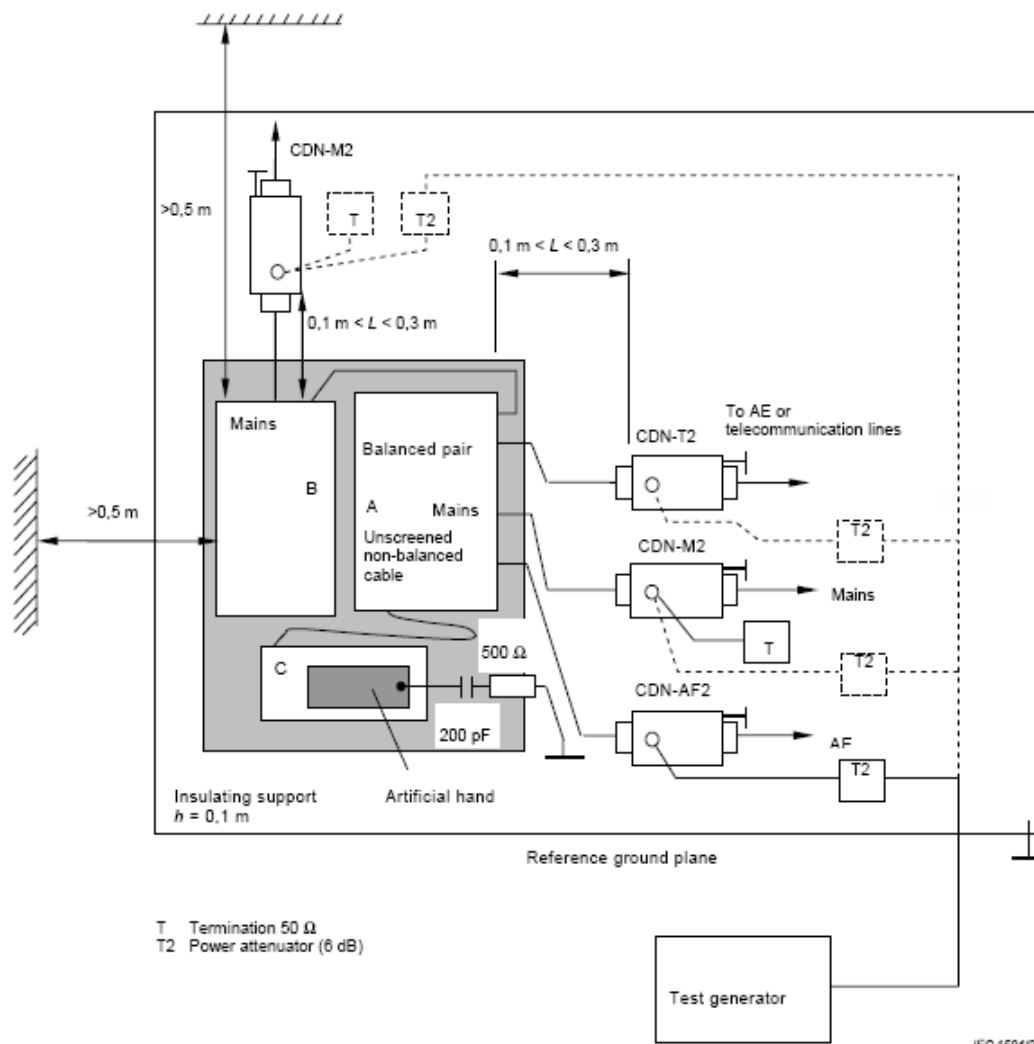

- Note:**
1. The EUT clearance from any metallic obstacles shall be at least 0,5 m.
  2. Interconnecting cables ( $\leq 1$  m) belonging to the EUT shall remain on the insulating support.

For the actual test configuration, please refer to the related item – Photographs of the Test Configuration.

**NOTE:**

The equipment to be tested is placed on an insulating support of 0.1 meters height above a ground reference plane. All relevant cables shall be provided with the appropriate coupling and decoupling devices at a distance between 0.1 meters and 0.3 meters from the projected geometry of the EUT on the ground reference plane.

### 5.9.6 TEST RESULTS

<b>TEST MODE</b>	Mode 1	<b>INPUT POWER</b>	230Vac, 50 Hz
<b>ENVIRONMENTAL CONDITIONS</b>	24deg. C, 62%RH	<b>TESTED BY:</b> Todd Chang	

<b>FREQUENCY (MHz)</b>	<b>FIELD STRENGTH (V<sub>r.m.s.</sub>)</b>	<b>CABLE</b>	<b>INJECTION METHOD</b>	<b>RETURN PATH</b>	<b>OBSER- VATION</b>	<b>PERFORMANCE CRITERION</b>
0.15 – 80	3	AC power line	CDN-M2	N/A	Note	A

**NOTE:** There was no change compared with the initial operation during the test.

## 5.10 POWER FREQUENCY MAGNETIC FIELD IMMUNITY TEST

### 5.10.1 TEST SPECIFICATION

*For EN 55024 only*

<b>Basic Standard:</b>	IEC 61000-4-8
<b>Frequency Range:</b>	50 Hz
<b>Field Strength:</b>	1 A/m
<b>Observation Time:</b>	1 minute
<b>Inductance Coil:</b>	Rectangular type, 1 m x 1 m

### 5.10.2 TEST INSTRUMENTS

DESCRIPTION & MANUFACTURER	MODEL NO.	SERIAL NO.	CALIBRATED DATE	CALIBRATED UNTIL
HAEFELY Magnetic Field Tester	MAG 100.1	083794-06	NA	NA
COMBINOVA Magnetic Field Meter	MFM10	224	Mar. 02, 2011	Mar. 01, 2012

**NOTE:** 1. The test was performed in EMS Room No. 1.  
 2. The calibration interval of the above test instruments is 12 months and the calibrations are traceable to NML/ROC and NIST/USA.

### 5.10.3 TEST PROCEDURE

- The equipment is configured and connected to satisfy its functional requirements.
- The power supply, input and output circuits shall be connected to the sources of power supply, control and signal.
- The cables supplied or recommended by the equipment manufacturer shall be used. 1 meter of all cables used shall be exposed to the magnetic field.

### 5.10.4 DEVIATION FROM TEST STANDARD

No deviation

## 5.10.5 TEST SETUP

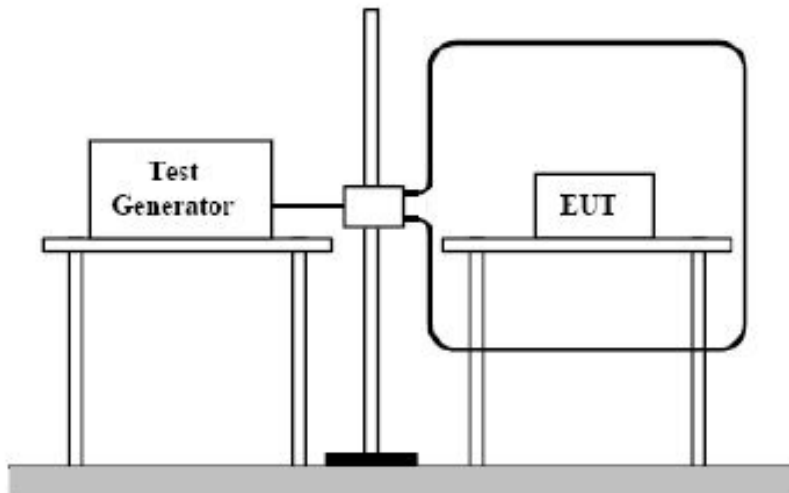

For the actual test configuration, please refer to the related item – Photographs of the Test Configuration.

### NOTE:

#### TABLETOP EQUIPMENT

The equipment shall be subjected to the test magnetic field by using the induction coil of standard dimension (1 m x 1 m). The induction coil shall then be rotated by 90 degrees in order to expose the EUT to the test field with different orientations.

#### FLOOR-STANDING EQUIPMENT

The equipment shall be subjected to the test magnetic field by using induction coils of suitable dimensions. The test shall be repeated by moving and shifting the induction coils, in order to test the whole volume of the EUT for each orthogonal direction. The test shall be repeated with the coil shifted to different positions along the side of the EUT, in steps corresponding to 50 % of the shortest side of the coil. The induction coil shall then be rotated by 90 degrees in order to expose the EUT to the test field with different orientations.



### 5.10.6 TEST RESULTS

<b>TEST MODE</b>	Mode 1	<b>INPUT POWER</b>	230Vac, 50 Hz
<b>ENVIRONMENTAL CONDITIONS</b>	27deg. C, 70%RH	<b>TESTED BY:</b> Ted Huang	

<b>Direction</b>	<b>Field Strength (A/m)</b>	<b>Observation</b>	<b>Performance Criterion</b>
X - Axis	1	Note	A
Y - Axis	1	Note	A
Z - Axis	1	Note	A

**NOTE:** There was no change compared with the initial operation during the test.



## 5.11 VOLTAGE DIP/SHORT INTERRUPTIONS/VOLTAGE VARIATIONS (DIP) IMMUNITY TEST

### 5.11.1 TEST SPECIFICATION

<b>Basic Standard:</b>	IEC 61000-4-11
<b>Test Duration Time:</b>	Minimum three test events in sequence
<b>Interval between Event:</b>	Minimum ten seconds
<b>Phase Angle:</b>	0° & 180°
<b>Test Cycle:</b>	3 times

### 5.11.2 TEST INSTRUMENTS

DESCRIPTION & MANUFACTURER	MODEL NO.	SERIAL NO.	CALIBRATED DATE	CALIBRATED UNTIL
HAEFELY Mains Interference Simulator	PLINE1610	083690-17	Jun 02, 2011	Jun 01, 2012

- NOTE:** 1. The test was performed in EMS Room No. 1.  
2. The calibration interval of the above test instruments is 12 months and the calibrations are traceable to NML/ROC and NIST/USA.

### 5.11.3 TEST PROCEDURE

The EUT shall be tested for each selected combination of test levels and duration with a sequence of three dips/interruptions with intervals of 10 s minimum (between each test event). Each representative mode of operation shall be tested. Abrupt changes in supply voltage shall occur at zero crossings of the voltage waveform.

### 5.11.4 DEVIATION FROM TEST STANDARD

No deviation

### 5.11.5 TEST SETUP

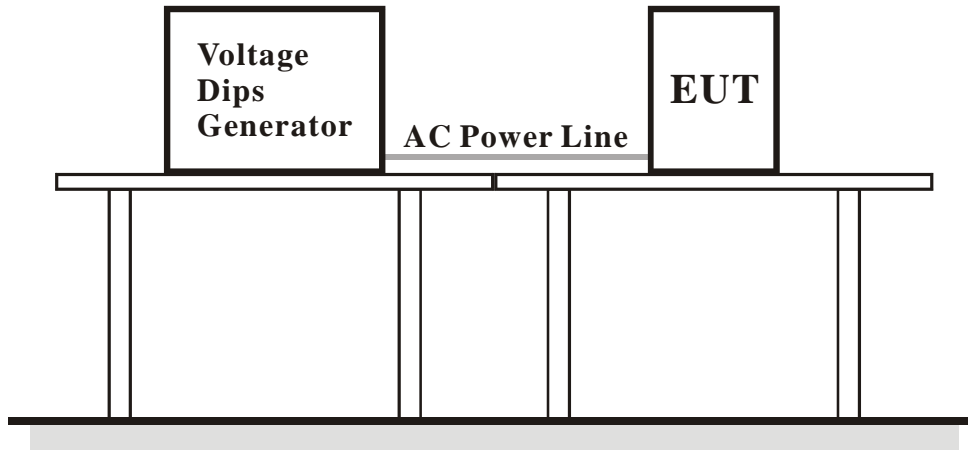

For the actual test configuration, please refer to the related item – Photographs of the Test Configuration.

### 5.11.6 TEST RESULTS – FOR EN 61204-3

<b>TEST MODE</b>	Mode 1	<b>INPUT POWER</b>	230Vac, 50Hz & 100Vac, 50Hz
<b>ENVIRONMENTAL CONDITIONS</b>	27deg. C, 70%RH	<b>TESTED BY:</b> Ted Huang	

<b>INPUT POWER FOR TESTING: 230VAC, 50Hz</b>			
<b>VOLTAGE % REDUCTION</b>	<b>DURATIONS (ms)</b>	<b>OBSERVATION</b>	<b>PERFORMANCE CRITERION</b>
30	10	Note (1)	A
60	100	Note (1)	A
>95	5000	Note (2)	B

<b>INPUT POWER FOR TESTING: 100VAC, 50Hz</b>			
<b>VOLTAGE % REDUCTION</b>	<b>DURATIONS (ms)</b>	<b>OBSERVATION</b>	<b>PERFORMANCE CRITERION</b>
30	10	Note (1)	A
60	100	Note (2)	B
>95	5000	Note (2)	B

**NOTE:** (1) There was no change compared with the initial operation during the test.  
 (2) The EUT reset during the test.

### 5.11.7 TEST RESULTS – FOR EN 55024

<b>TEST MODE</b>	Mode 1	<b>INPUT POWER</b>	230Vac, 50Hz & 100Vac, 50Hz
<b>ENVIRONMENTAL CONDITIONS</b>	27deg. C, 70%RH	<b>TESTED BY:</b> Ted Huang	

<b>INPUT POWER FOR TESTING: 230VAC, 50HZ</b>			
<b>VOLTAGE % REDUCTION</b>	<b>PERIOD</b>	<b>OBSERVATION</b>	<b>PERFORMANCE CRITERION</b>
>95	0.5	Note (1)	A
30	25	Note (1)	A
>95	250	Note (2)	B

<b>INPUT POWER FOR TESTING: 100VAC, 50HZ</b>			
<b>VOLTAGE % REDUCTION</b>	<b>PERIOD</b>	<b>OBSERVATION</b>	<b>PERFORMANCE CRITERION</b>
>95	0.5	Note (1)	A
30	25	Note (1)	A
>95	250	Note (2)	B

**NOTE:** (1) There was no change compared with the initial operation during the test.  
 (2) The EUT reset during the test.

## 6 PHOTOGRAPHS OF THE TEST CONFIGURATION

### CONDUCTED EMISSION TEST

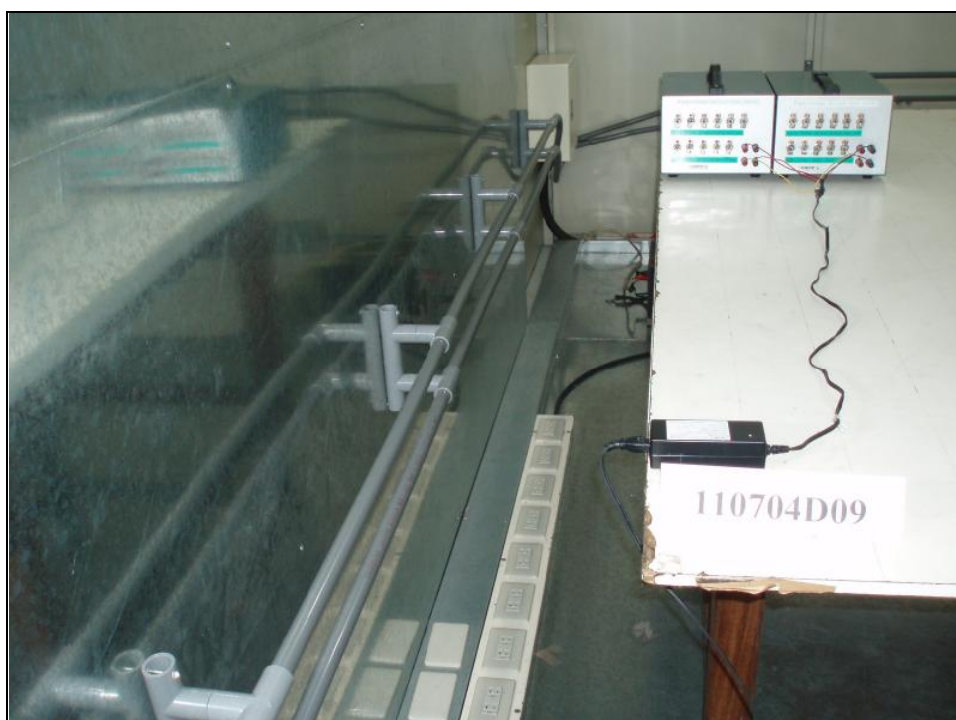

## RADIATED EMISSION TEST

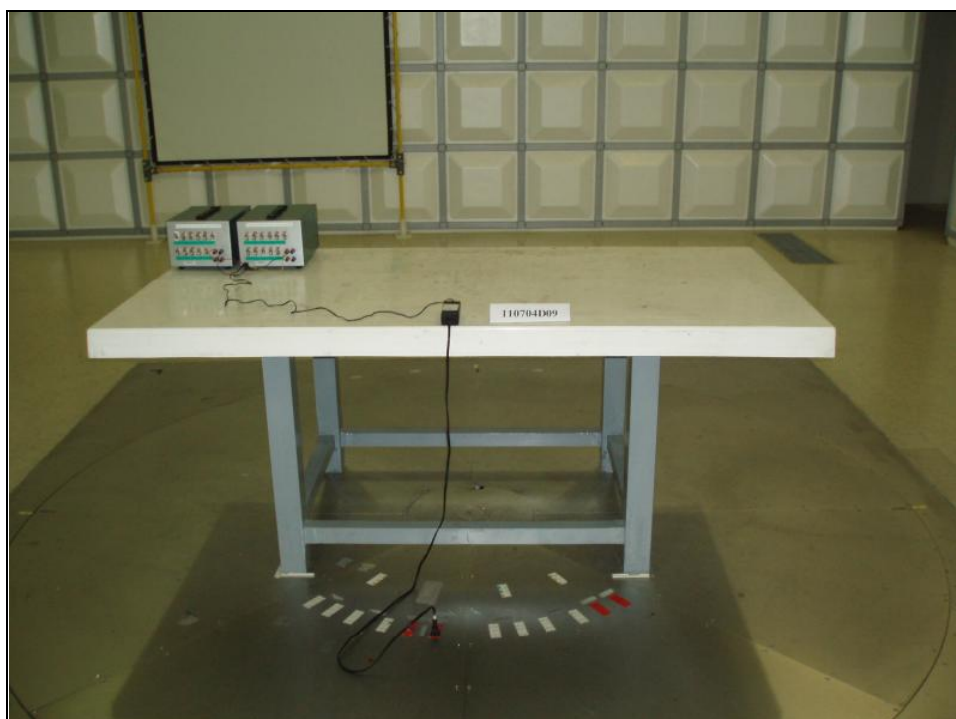

## HARMONICS EMISSION TEST & VOLTAGE FLUCTUATIONS AND FLICKER TEST





### ESD TEST



### ESD TEST POINT

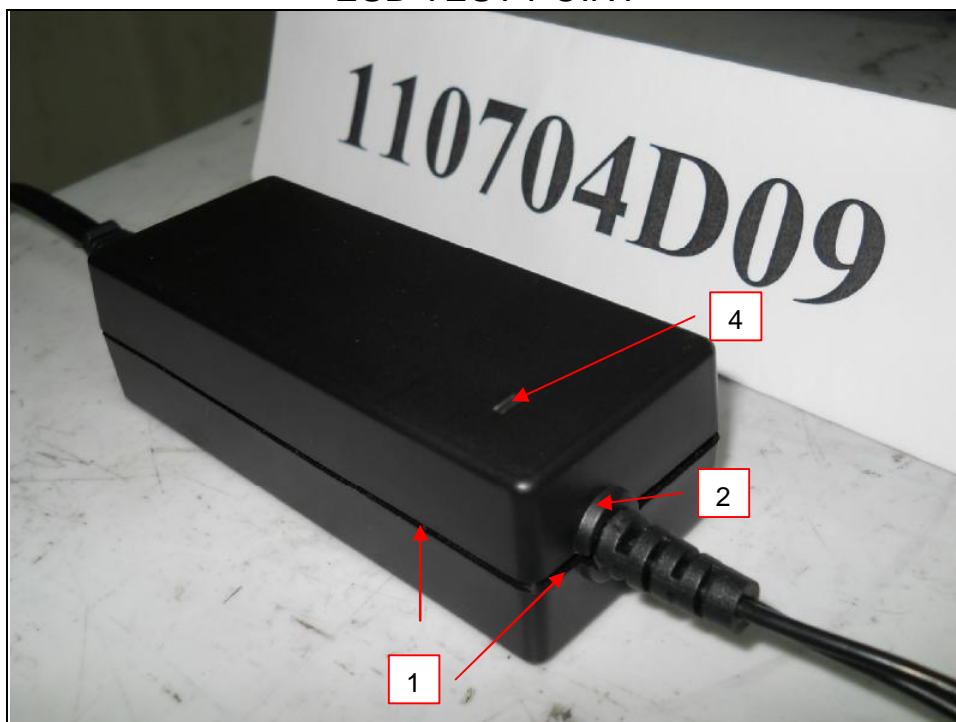

### ESD TEST POINT

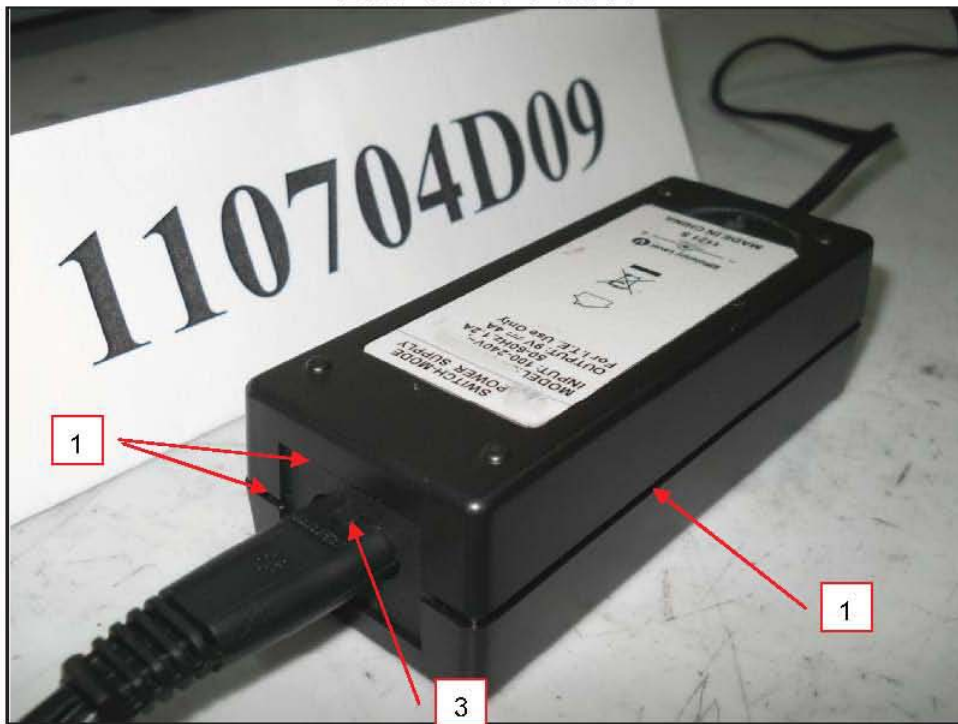

## RS TEST



### EFT TEST

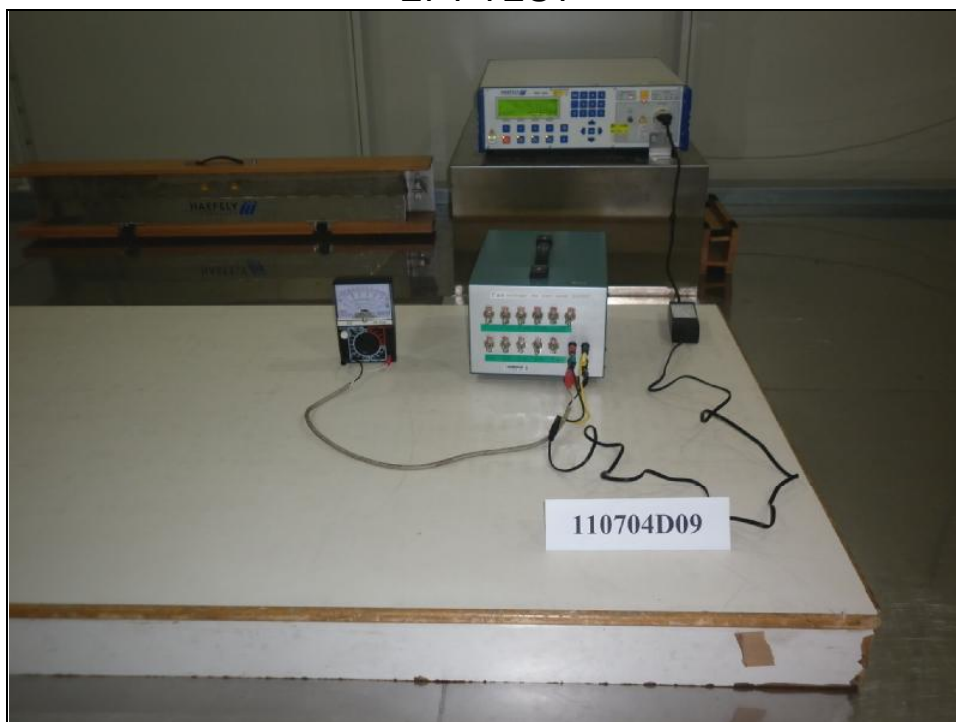

### SURGE TEST

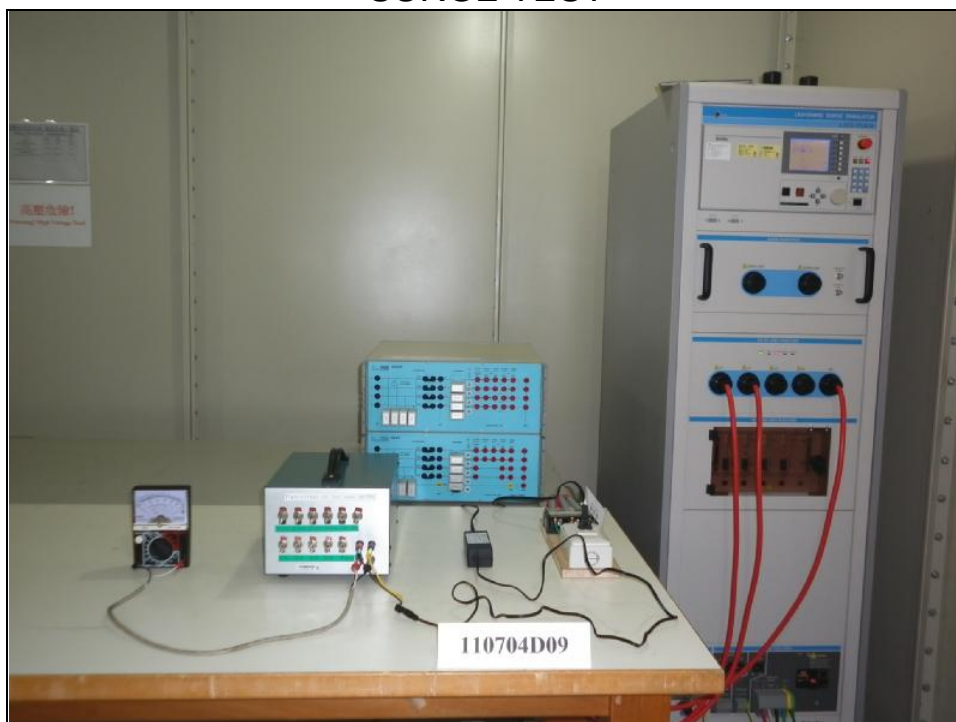



### CONDUCTED SUSCEPTIBILITY TEST



### POWER-FREQUENCY MAGNETIC FIELDS TEST – *For EN 55024 only*



## VOLTAGE DIPS AND INTERRUPTIONS TEST





## 7 APPENDIX - INFORMATION ON THE TESTING LABORATORIES

We, Bureau Veritas Consumer Products Services (H.K.) Ltd., Taoyuan Branch, were founded in 1988 to provide our best service in EMC, Radio, Telecom and Safety consultation. Our laboratories are accredited and approved according to ISO/IEC 17025.

Copies of accreditation and authorization certificates of our laboratories obtained from approval agencies can be downloaded from our web site: [www.adt.com.tw/index.5.phtml](http://www.adt.com.tw/index.5.phtml). If you have any comments, please feel free to contact us at the following:

**Linko EMC/RF Lab:**

Tel: 886-2-26052180

Fax: 886-2-26051924

**Hsin Chu EMC/RF Lab:**

Tel: 886-3-5935343

Fax: 886-3-5935342

**Hwa Ya EMC/RF/Safety/Telecom Lab:**

Tel: 886-3-3183232

Fax: 886-3-3185050

**Email:** [service.adt@tw.bureauveritas.com](mailto:service.adt@tw.bureauveritas.com)

**Web Site:** [www.adt.com.tw](http://www.adt.com.tw)

The address and road map of all our labs can be found in our web site also.

--- END ---