



Test Report issued under the responsibility of:



**IEC 60601-1
Medical electrical equipment**

Part 1: General requirements for basic safety and essential performance

Report Reference No.....: T223-0143/12
Date of issue: 2012-05-16
Total number of pages.....: 269 pages

CB Testing Laboratory.....: **SIQ – Slovenian Institute of Quality and Metrology**
Testing Laboratory is accredited by Slovenian Accreditation, Reg. No.: LP-009
Address: **Tržaška cesta 2, 1000 Ljubljana, Slovenia**

Applicant's name.....: **GlobTek, Inc.**
Address: **186 Veterans Drive, Northvale, NJ 07647, USA**

Test specification:
Standard: **IEC 60601-1: 2005 + CORR. 1 (2006) + CORR. 2 (2007)**
Test procedure.....: **CB Scheme**
Non-standard test method.....: **N/A**

Test Report Form No.....: **IEC60601_1G**
Test Report Form Originator.....: **Underwriters Laboratories Inc.**
Master TRF: **Dated 2011-11**



Copyright © 2011 IEC System for Conformity Testing and Certification of Electrical Equipment (IECEE), Geneva, Switzerland. All rights reserved.

This publication may be reproduced in whole or in part for non-commercial purposes as long as the IECEE is acknowledged as copyright owner and source of the material. IECEE takes no responsibility for and will not assume liability for damages resulting from the reader's interpretation of the reproduced material due to its placement and context.

If this Test Report Form is used by non-IECEE members, the IECEE/IEC logo shall be removed

This report is not valid as a CB Test Report unless signed by an approved CB Testing Laboratory and appended to a CB Test Certificate issued by an NCB in accordance with IECEE 02.

Test item description: **Switch Mode Power Supply for Building-In**
Trade Mark:  **GlobTek, Inc.**
Manufacturer.....: **GlobTek, Inc.**
186 Veterans Drive, Northvale, NJ 07647, USA
Model/Type reference.....: **GTM91092-110-M**
Ratings: **I/P: 100-240 V~; 50-60 Hz; 3,0-1,5 A; Class I**
O/P: DC1: + 5 Vdc / 6 A
DC2: + 5 Vdc / 3 A
DC3: - 5 Vdc / 1 A
DC4: 0 to + 130 Vdc / 0,1 A
DC5: + 13,5 Vdc / 2,5 A

Testing procedure and testing location:	
<input checked="" type="checkbox"/> CB Testing Laboratory:	SIQ – Slovenian Institute of Quality and Metrology
Testing location/ address.....:	Tržaška cesta 2, 1000 Ljubljana, Slovenia
<input type="checkbox"/> Associated CB Test Laboratory:	
Testing location/ address.....:	
Tested by (name + signature) ..:	Janez Vidmar 
Approved by (+ signature)	Boštjan Glavič 
<input type="checkbox"/> Testing procedure: TMP	
Tested by (name + signature) ..:	
Approved by (+ signature)	
Testing location/ address.....:	
<input type="checkbox"/> Testing procedure: WMT	
Tested by (name + signature) ..:	
Witnessed by (+ signature)	
Approved by (+ signature)	
Testing location/ address.....:	
<input type="checkbox"/> Testing procedure: SMT	
Tested by (name + signature) ..:	
Approved by (+ signature)	
Supervised by (+ signature).....:	
Testing location/ address.....:	
<input type="checkbox"/> Testing procedure: RMT	
Tested by (name + signature) ..:	
Approved by (+ signature)	
Supervised by (+ signature).....:	
Testing location/ address.....:	

List of Attachments (including a total number of pages in each attachment):

1. Test Report (204 pages)
2. National Differences to IEC 60601-1:2005 – Enclosure No. 1 (11 pages)
3. Photo documentation – Enclosure No. 2 (6 pages)
4. Schematics, layouts and transformer drawings – Enclosure No. 3 (47 pages)

Summary of testing

Tests performed (name of test and test clause):	Testing location:
See next pages	SIQ – Slovenian Institute of Quality and Metrology
The risk management requirements of the standard were not addressed.	Tržaška cesta 2, 1000 Ljubljana, Slovenia







Summary of compliance with National Differences (See enclosure No. 1 for details)

List of countries addressed:

- **US NATIONAL DIFFERENCES to IEC 60601-1 Third edition**
National standard ANSI/AAMI ES60601-1: 2005
- **CANADA NATIONAL DIFFERENCES to IEC 60601-1 Third edition**
National standard CAN/CSA-C22.2 No. 60601-1:08
- **SWITZERLAND NATIONAL DIFFERENCES to IEC 60601-1 Third edition**
National standard SN EN 60601-1:06

Copy of marking plate

The artwork below may be only a draft. The use of certification marks on a product must be authorized by the respective NCBs that own these marks.

 GlobTek, Inc. MEDICAL POWER SUPPLY MODEL:GTM91092-110-M INPUT:100-240~, 50-60Hz, 3.0~1.5A	OUTPUT: 5VDC @ 6A 5VDC @ 3A -5VDC @ 1A 13.5VDC @ 2.5A 0-130VDC @ 0.1A	 
	 IEC 60601-1 RoHS	
		
MADE IN CHINA		

Tests performed (name of test and test clause):		Verdict
4.11	Power Input	P
7.1.3	Durability of marking	P
8.4	Limitation of voltage current and energy	P
8.5.5.	Defibrillation- proof applied parts	N/A
8.6.4.	Impedance and current- carrying capability of protective earth connections	P
8.7.4.5	Earth Leakage Current	P
8.7.4.6.	Touch Current	N/A
8.7.4.7.	Patient Leakage Current	N/A
8.7.4.8.	Patient Auxiliary Current	N/A
8.7.4.9.	Multiple Patient Connections	N/A
8.8.3A	Dielectric Strength test of solid insulation materials with safety functions- MOOP	P
8.8.3B	Dielectric Strength test of solid insulation materials with safety functions- MOPP	N/A
8.9.2	Short circuits in Mains part over creepage and clearance distances	P
8.9.3.2	Thermal Cycling Test on one sample of insulation compound forming solid insulation between conductive parts	N/A
8.9.3.4	Thermal Cycling test on one Sample of Cemented joint	N/A
9.2.2.2	Measurement of gap "a" according to table 20 (ISO 13452:1996)	N/A
10.1.1	Measurement of X- radiation	N/A
11.1	Excessive temperatures in ME EQUIPMENT	P
11.2.2.1	Existence of ignition sources	N/A
13.1	Power or energy dissipation	N/A
13.2	Single Fault conditions	P
15.3	Mechanical strength	P
15.4.6	Actuating parts of controls	N/A
15.5.1.2	Transformer short circuit	P
15.5.1.3	Transformer overload	P
15.5.2	Transformer dielectric strength after humidity preconditioning of 5.7	N/A
--	Working voltage Measurement	P

GENERAL INFORMATION	
Test item particulars (see also Clause 6):	
Classification of installation and use	Equipment for building-in
Device type (component/sub-assembly/ equipment/ system)	Component level power supply
Intended use (Including type of patient, application location)	EUT is intended to provide power to medical devices with isolation grade MOOP
Mode of operation	Continuous
Supply connection	Appliance coupler
Accessories and detachable parts included	No accessories and detachable parts
Other options include.....	No other options included
Testing	
Date of receipt of test item(s)	2012-02-06
Dates tests performed.....	From 2012-02-27 to 2012-05-10
Possible test case verdicts:	
- test case does not apply to the test object	N/A
- test object does meet the requirement	Pass (P)
- test object was not evaluated for the requirement	N/E
- test object does not meet the requirement.....	Fail (F)
Abbreviations used in the report:	
- normal condition	N.C.
- single fault condition	S.F.C.
- means of Operator protection	MOOP
- means of Patient protection ...	MOPP
General remarks:	
"(see Attachment #)" refers to additional information appended to the report.	
"(see appended table)" refers to a table appended to the report.	
The tests results presented in this report relate only to the object tested.	
This report shall not be reproduced except in full without the written approval of the testing laboratory.	
List of test equipment must be kept on file and available for review.	
Additional test data and/or information provided in the attachments to this report.	
Throughout this report a <input checked="" type="checkbox"/> comma / <input type="checkbox"/> point is used as the decimal separator.	

Manufacturer's Declaration per sub-clause 6.2.5 of IECEE 02:

The application for obtaining a CB Test Certificate includes more than one factory location and a declaration from the Manufacturer stating that the sample(s) submitted for evaluation is (are) representative of the products from each factory has been provided..... :

Yes
 Not applicable

When differences exist; they shall be identified in the General product information section.

Name and address of factory (ies)..... :

- 1) GlobTek Inc.
Corporate Headquarters, 186 Veterans Drive,
Northvale, NJ 07647, USA
- 2) GlobTek (Suzhou) Co., Ltd.
Building 4, No. 76, Jinling East Road, Suzhou
Industrial Park, Jiangsu 215021, China

General product information:

Equipment under test (Model: GTM91092-110-M) is switch mode power supply unit intended for building in the end medical product. Equipment provides five outputs. Those outputs shall not be accessible by the user and are only used for supplying end medical product by its output voltages.

Equipment under test (Model: GTM91092-110-M) is provided with metal enclosure and in incorporated two ventilation fans inside the enclosure. Openings provided on the right side of the enclosure, on the back left side of the enclosure (near ventilation fans) and on the right side of the enclosure. See pictures below. Those openings are not accessible when the power supply unit is mounted inside the end medical product.



Marking plate is provided on the back side of the enclosure. It is not visible when the power supply unit is build-in the end medical product. Type and fuse rating of external accessible fuses is provided on the front side of the enclosure.

Transformers and inductors constructions are enclosed to the test report. See Enclosure No. 2 for details.

The Power Supply GTM91092-110-M has been designed for the supplying various medical devices with integrated 2 x MOOP isolation (means of operator protection) between primary and secondary circuit and integrated 1 x MOOP between primary circuit and protective earth.

Power supply is not intended for direct patient connection.

The power supply unit is provided with incorporated appliance coupler and it is constructed for wide range mains voltage.

Power supply cord not part of the investigation.

The power supply in maintenance free.

The power supply is intended for operating at ambient temperature up to 55°C.

The unit shall not be used for use in an oxygen rich environment.

The unit it is not intended to be use with flammable anaesthetics and not intended for use in conjunction with flammable agents.

Compliance with IEC / EN 60601-1-2 shall be evaluated during the end medical product approval.

Summary of testing:

The risk management requirements of the standard were not addressed. The power supply tested in this test report is only component level power supply. Risk management shall be addressed to the end type medical equipment.

Switch Mode Power Supply Unit has been judged on the basis of the required spacing in the Third Edition of the Standard for Medical Electrical Equipment, Part 1: General Requirements for basic safety and essential performance, IEC 60601-1:2005, which covers the end use product for which the component is designed.

Essential performance shall be determined within the end medical equipment; however for this medical power supply essential performance is considered MOOP. MOOP is tested within this test report:

The unit is for building-in equipment.

The unit provide two fuses mounted inside approved appliance coupler. One in line and one in neutral pole.

The earth leakage current test was performed for information only and has to be verified in the end use application. Outputs are intended only for supplying end medical product by its output voltages and therefore patient leakage current is not applicable. Metal enclosure of the equipment is protectively earthed and therefore touch leakage current is not applicable.

Power supply unit was evaluated only for MOOP (Means of Operator Protection):

- 2 x MOOP between primary and secondary circuit (PCB, transformer, bridging capacitors, optocouplers)
- 1 x MOOP between primary and protective earth (PCB, bridging capacitors)

The power supply is rated as class I. The power supply shall be properly bonded to the main protective bonding termination in the end product. The earth leakage current is below 3,5mA. An investigation of the protective bonding terminal has been conducted.

The transformer T2 provide reinforced insulation. This transformer is built up to fulfil the requirement of insulation class B. See also list of safety critical components.

The equipment has been evaluated for use in a Pollution Degree 2 and overvoltage category II environment and a maximum altitude of 2000m.

Switching Power Supply was evaluated for a maximum ambient temperature of 55°C with 100% output power.

Power supply unit is provided in aluminium enclosure. Only front side of the equipment shall be accessible by the user.

A suitable Electrical and Fire enclosure shall be provided in the end equipment

Cleaning and other applicable tests shall be considered within end product investigation.

Switching Power Supply is shipped without manual as required for a medical end product. The manual has to be part of the end medical product. Only technical specifications provided by the manufacturer of the power supply unit.

The output circuits have not been evaluated for direct patient connection (Type B, BF or CF). Outputs are intended only for supplying end medical product by its output voltages.

Only functional insulation between high voltage output (DC4) and other outputs provided. Short circuit between high voltage (130 Vdc max.) and other outputs performed. See table 13.2: Abnormal operation.

Consideration should be given to the measuring of the temperature rises according to the standard IEC 60601-1:2005 within the end medical product.

Consideration should be given to the accompanying documents of the end medical product.

Consideration should be given to the indicator lights of the end medical product. Power supply unit is intended for building-in and provided without indicator lights.

Switch Mode Power Supply Unit is intended for building in and shall be installed in compliance with the enclosure, mounting, spacing and segregation requirements of the end use application.

Power supply unit was not evaluated for use in an oxygen rich environment.

Power supply unit was not evaluated for use with flammable anaesthetics and was not evaluated for use in conjunction with flammable agents.

Power supply cord not part of the investigation.

IEC 60601-1

Clause	Requirement + Test	Result - Remark	Verdict
--------	--------------------	-----------------	---------

INSULATION DIAGRAM

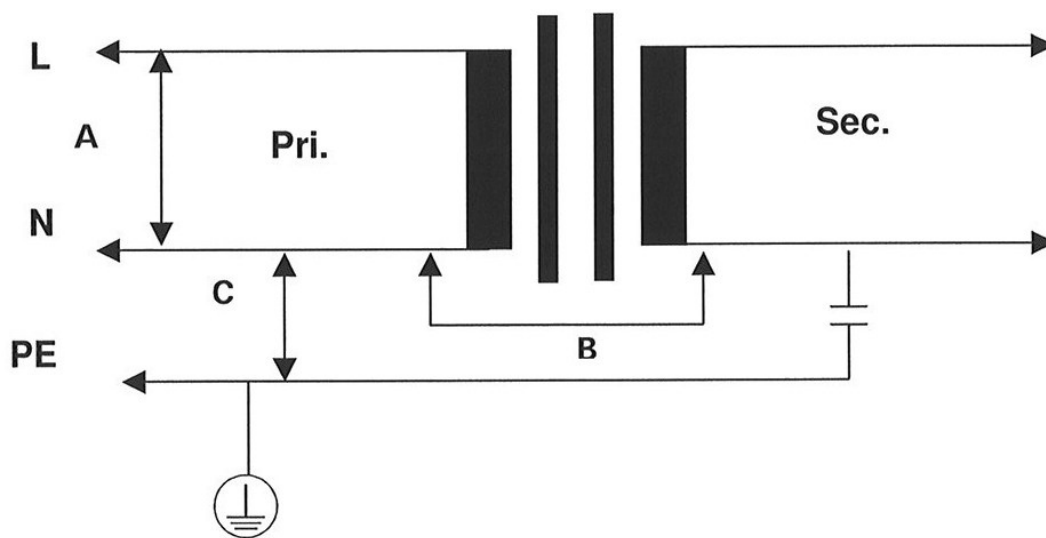

IEC 60601-1			
Clause	Requirement + Test	Result - Remark	Verdict

TABLE: To insulation diagram									P
Pollution degree				PD 2					—
Overvoltage category				OVC II					—
Altitude.....				Up to 2.000 meters					—
Additional details on parts considered as applied parts				<input checked="" type="checkbox"/> None <input type="checkbox"/> Areas _____ (See Clause 4.6 for details)					—
Area	Number and type of Means of Protection: MOOP, MOPP	CTI (IIIb, unless is known)	Working voltage		Required creepage (mm)	Required clearance (mm)	Measured creepage (mm)	Measured clearance (mm)	Remarks
			Vrms	Vpk					
A	1xMOOP	IIIb	250	354	3,0	1,6	Verified by short circuit. Approved appliance inlet with incorporated fuse holder for two primary fuses provided. See list of critical components.		
A1	1xMOOP	IIIb	250	354	Verified by short circuit (after primary fuses)				
B1	2x MOOP	IIIb	384	600	8,0	4,6	8,0	5,6	Under optocoupler U6 See 1)
B2	2x MOOP	IIIb	384	600	8,0	4,6	9,4	5,7	Below transformer T2 on PCB
B3	2x MOOP	IIIb	384	600	8,0	4,6	8,0	5,4	Under optocouplers U7, U300 See 2)
B4	2x MOOP	IIIb	384	600	8,0	4,6	8,2	8,2	R305 and secondary track
B5	2x MOOP	IIIb	384	600	8,0	4,6	9,9	9,9	Transformer T2 pin and R150
B6	2x MOOP	IIIb	384	600	8,0	4,6	10,8	9,0	Primary track and connector CON1 See 3)
B7	2x MOOP	IIIb	384	600	8,0	4,6	17,1	8,1	HS2 heat sink and L117 body See 4)

IEC 60601-1									
Clause	Requirement + Test				Result - Remark				Verdict
B8	2x MOOP	IIIb	384	600	8,0	4,6	17,1	7,1	HS2 heat sink and secondary track See 4)
B9a	1x MOOP	IIIb	384	600	4,0	2,3	4,0	4,0	Under bridging capacitors C310 See 5)
B9b	1x MOOP	IIIb	384	600	4,0	2,3	4,0	4,0	Under bridging capacitor C311 See 5)
B11	2x MOOP	IIIb	384	600	8,0	4,6	8,1	8,1	Transformer T2 See 6)
C	1x MOOP	IIIb	250	354	2,5	2,0	4,0	4,0	Primary track to PE
C	1x MOOP	IIIb	250	354	2,5	2,0	4,9	4,9	Primary components to metal enclosure

Supplementary information:

- 1) Slot provided below optocoupler U6 (between primary and secondary pins). Width of the slot is 1,3 mm. The space between optocoupler body and PCB is 1,0 mm minimum.
- 2) Slot provided below optocoupler U7 and U300 (between primary and secondary pins). Width of the slot is 1,3 mm. The space between optocouplers body and PCB is 1,0 mm.
- 3) Slot provided between primary track and secondary track (output connector CON1). Width of the slot is 1,3 mm.
- 4) Insulation sleeving placed over the inductor L117. Additional insulation tape provided over the heat sink HS2. Between L117 and HS2 1,3 mm width slot provided.
- 5) Two approved Y2 capacitors in series provided between primary and secondary circuit of the switch mode power supply unit (C310, C311). See list of critical components for details.
- 6) Approved triple insulation wire used for secondary windings. See list of critical components for details.
- 7) Insulation foil provided between heat sinks and the followings components: Q3, Q1, D103, D102, U106, D104, and Q109. See list of critical components.
- 8) Insulation sleeving provided over the followings inductors: L302, L109, L105, L117, L111, L108, L115, L118, L112 and L113.

IEC 60601-1			
Clause	Requirement + Test	Result - Remark	Verdict

INSULATION DIAGRAM CONVENTIONS and GUIDANCE:

A measured value must be provided in the value columns for the device under evaluation. The symbol > (greater than sign) must not be used. Switch-mode power supplies must be re-evaluated in the device under evaluation therefore N/A must not be used with a generic statement that the component is certified.

Insulation diagram is a graphical representation of equipment insulation barriers, protective impedance and protective earthing. If feasible, use the following conventions to generate the diagram:

- All isolation barriers are identified by letters between separate parts of diagram, for example separate transformer windings, optocouplers, wire insulation, creepage and clearance distances.
- Parts connected to earth with large dots are protectively earthed. Other connections to earth are functional
- Applied parts are extended beyond the equipment enclosure and terminated with an arrow.
- Parts accessible to the operator only are extended outside of the enclosure, but are not terminated with an arrow.

IEC 60601-1			
Clause	Requirement + Test	Result - Remark	Verdict

Table: working voltage measurement GTM91092-110-M			P
Location	RMS voltage (V)	Peak voltage (V)	Comments
Transformer T2			
Pin 2 to PE	315	416	*
Pin 4 to PE	374	591	*
Pin 5 to PE	-357	170	*
Pin 6 to PE	174	432	*
Pin 4 to pin 7	358	568	*
Pin 4 to pin 8/9	373	584	*
Pin 4 to pin 10	334	527	*
Pin 4 to pin 11	384	600	*
Pin 4 to pin 12	365	576	*
Across Capacitors C311 & C310			
C311 to C310	168	352	*
Optocoupler U6			
Pin 1 to pin 3	180	373	*
Pin 1 to pin 4	179	368	*
Pin 2 to pin 3	179	368	*
Pin 2 to pin 4	178	367	*
Optocoupler U300			
Pin 1 to pin 3	173	360	*
Pin 1 to pin 4	172	360	*
Pin 2 to pin 3	172	359	*
Pin 2 to pin 4	172	359	*
Optocoupler U7			
Pin 1 to pin 3	180	368	*
Pin 1 to pin 4	171	352	*
Pin 2 to pin 3	180	368	*
Pin 2 to pin 4	171	352	*
supplementary information:			
Input voltage: 240Vac.			
* Test Condition: Rated load specified by manufacturer.			
The following terminals were connected to earth: Neutral and COM.			

IEC 60601-1			
Clause	Requirement + Test	Result - Remark	Verdict

Transformer T2

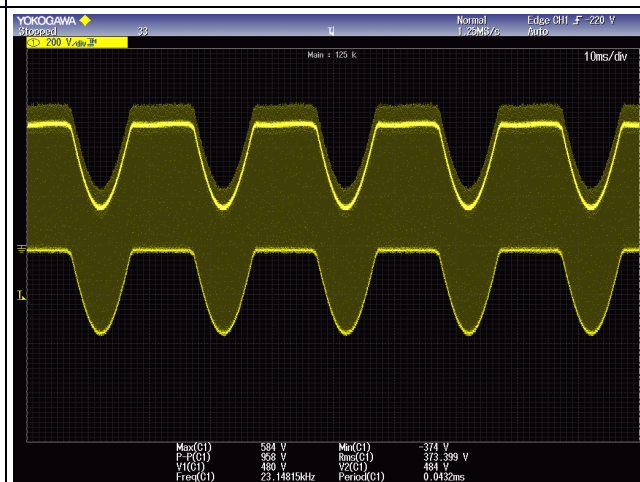
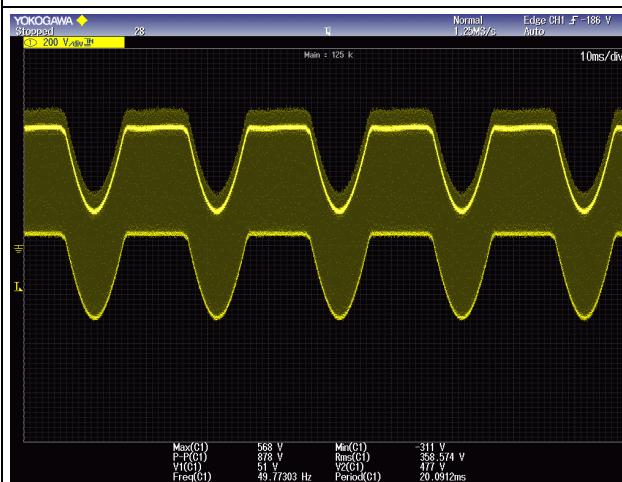
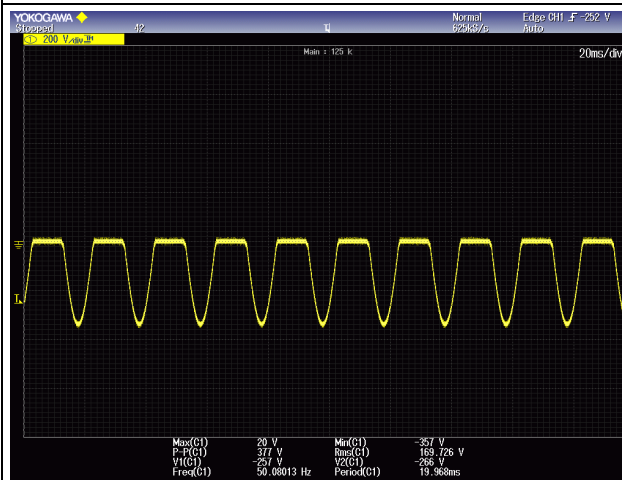
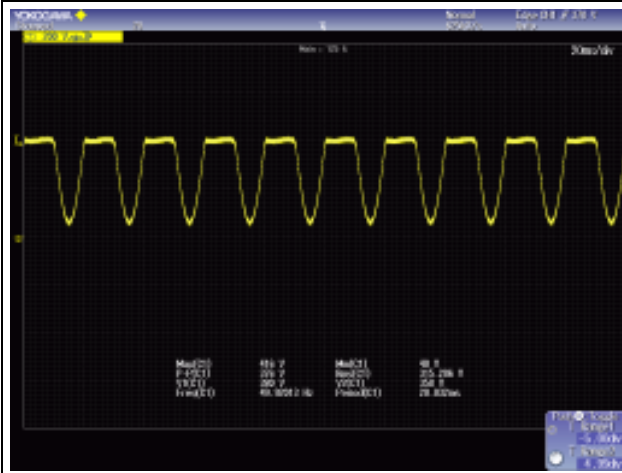

IEC 60601-1

Clause	Requirement + Test	Result - Remark	Verdict
--------	--------------------	-----------------	---------

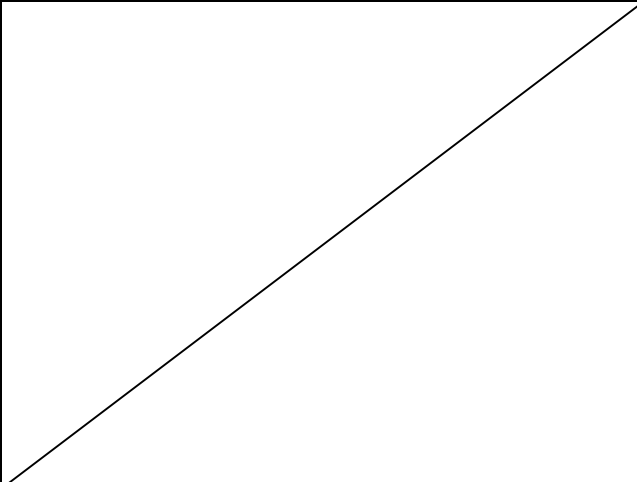
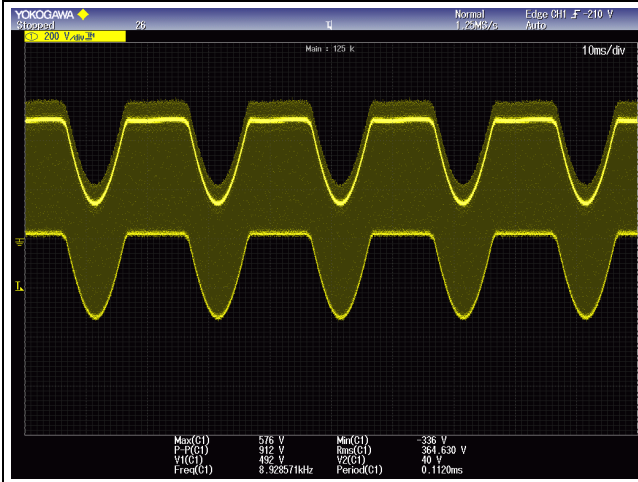
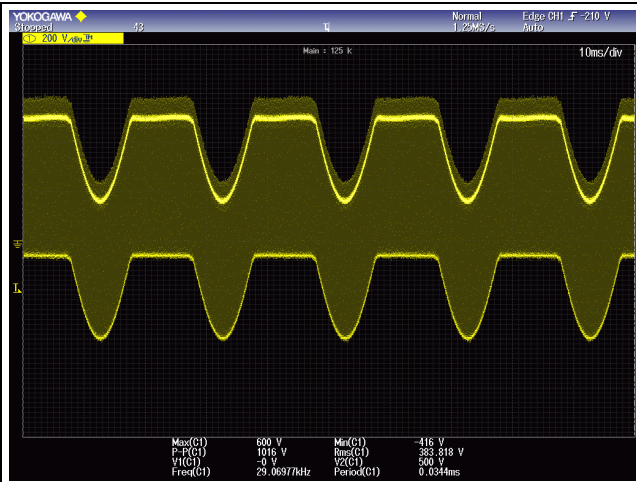
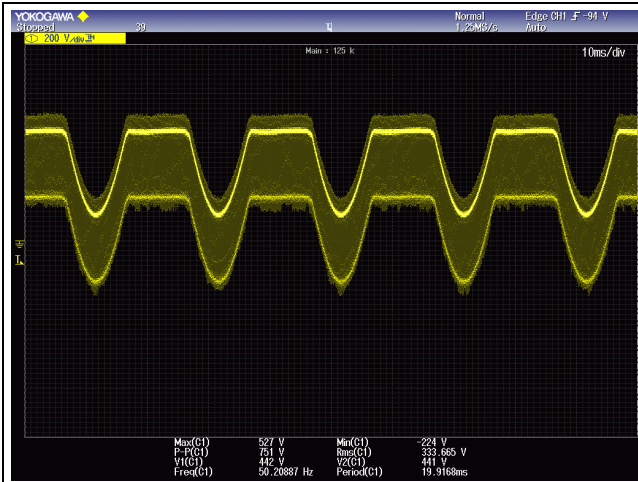

Across capacitors C311 & C310

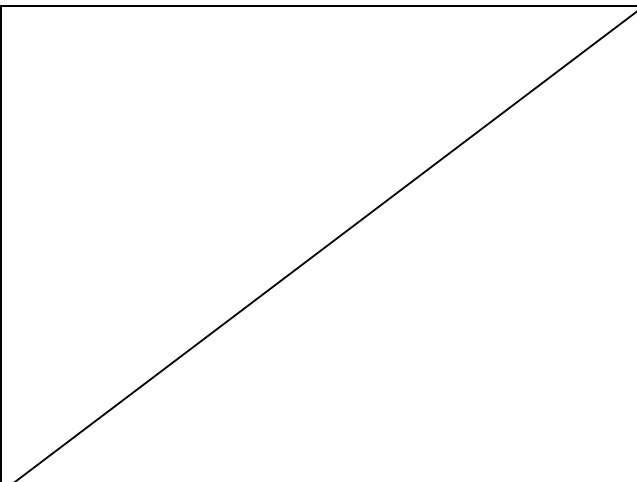

IEC 60601-1			
Clause	Requirement + Test	Result - Remark	Verdict

Optocoupler U6

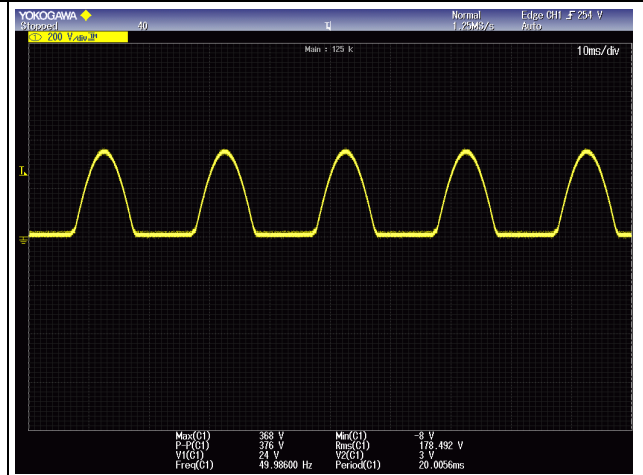
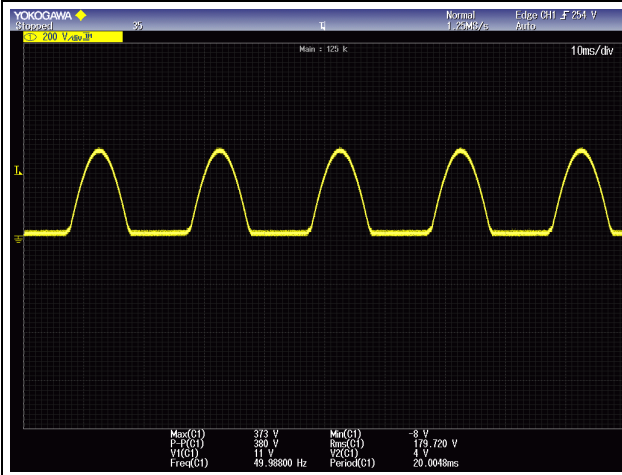

Optocoupler U300

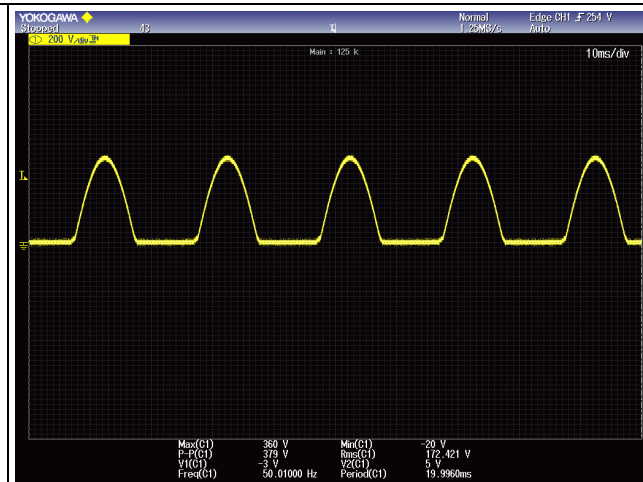
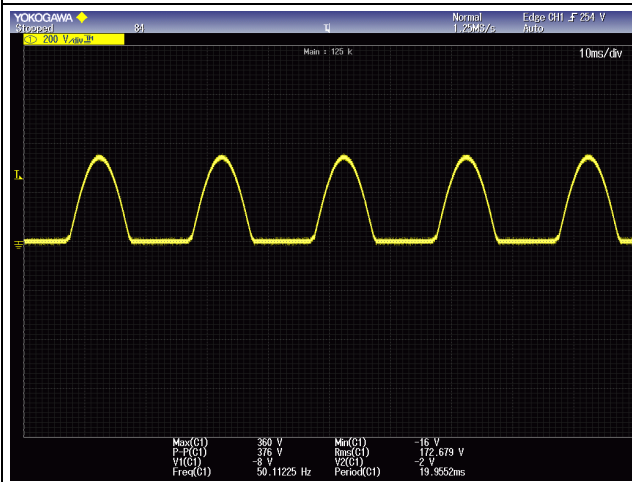

IEC 60601-1

Clause	Requirement + Test	Result - Remark	Verdict
--------	--------------------	-----------------	---------

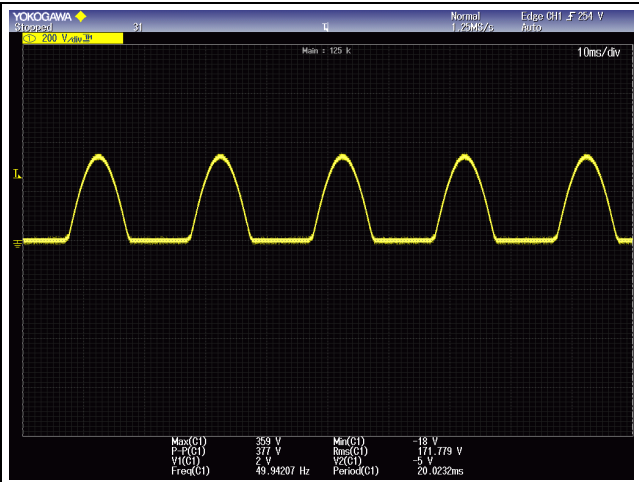

Optocoupler U7

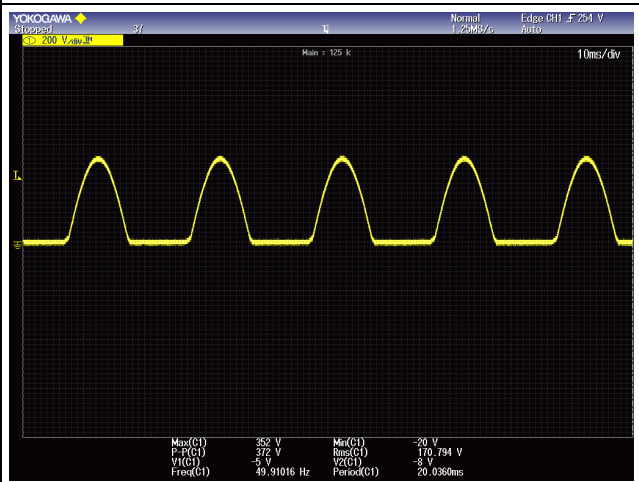
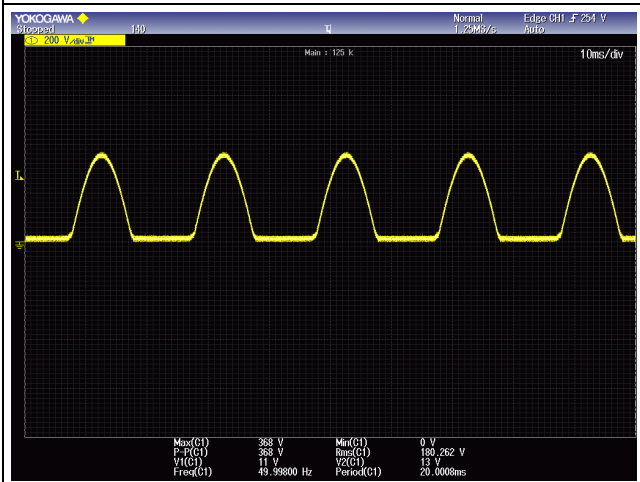
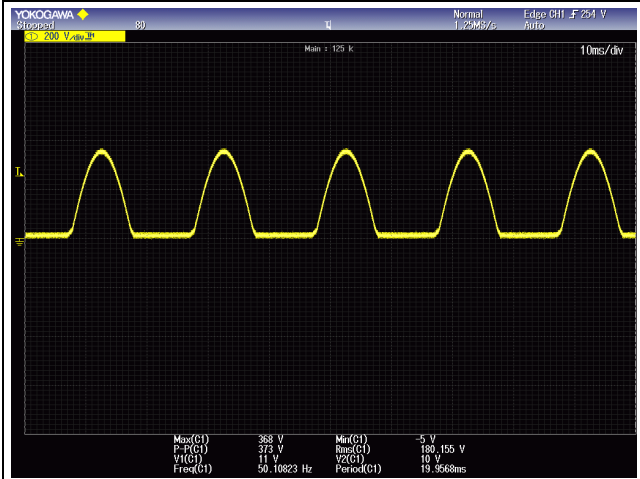

IEC 60601-1			
Clause	Requirement + Test	Result - Remark	Verdict
4	GENERAL REQUIREMENTS		P
4.1	Requirements of this standard applied in NORMAL USE and reasonably foreseeable misuse	--	P
4.2	A RISK MANAGEMENT PROCESS complying with ISO 14971 was performed	The risk management requirements of the standard were not addressed. EUT is component level medical power supply unit; therefore not classified as end medical product.	N/A
4.3	ESSENTIAL PERFORMANCE functions identified according to MANUFACTURER'S policy for RISK acceptability in RISK MANAGEMENT FILE.....:	See Appended Table 4.3 and RM Results Table 4.3	N/A
	ESSENTIAL PERFORMANCE functions maintained following particular tests as applicable	--	N/A
4.4	EXPECTED SERVICE LIFE stated in RISK MANAGEMENT FILE	--	N/A
4.5	Alternative means of addressing particular RISKS considered acceptable based on MANUFACTURER'S justification that RESIDUAL RISKS resulting from application of alternative means equal to or less than RESIDUAL RISKS resulting from requirements of this standard	See Appended RM Results Table 4.5	N/A
4.6	RISK MANAGEMENT PROCESS identifies parts that can come into contact with PATIENT but not defined as APPLIED PARTS, subjected to the requirements for APPLIED PARTS, except for Clause 7.2.10.....:	See Appended Insulation Diagram Table and RM Results Table 4.6	N/A
4.7	ME EQUIPMENT remained SINGLE FAULT SAFE, or the RISK remained acceptable as determined by Clause 4.2.....:	See Appended RM Results Table 4.7	P
	Failure of any one component at a time that could result in a HAZARDOUS SITUATION, including those in 13.1, simulated physically or theoretically	See Appended Table 13.2 for simulated physical test, or See Attachment No. __ for theoretical simulation	P
	Risk associated with failure of component during EXPECTED SERVICE LIFE of ME EQUIPMENT taken into account to evaluate if a component should be subjected to failure simulation	Short circuit or open circuit of relevant single components performed. See Table 13.2: Single fault conditions in accordance with 13.2.2 to 13.2.13, inclusive.	P

IEC 60601-1			
Clause	Requirement + Test	Result - Remark	Verdict
4.8	All components and wiring whose failure could result in a HAZARDOUS SITUATION used according to their applicable ratings, except as specified, or by RISK MANAGEMENT PROCESS.....:	See Appended RM Results Table 4.8 The RM requirements of the standard were not addressed. IEC approved components provided within the equipment. See Table 8.10 list of critical components.	P
	Reliability of components used as MEANS OF PROTECTION assessed for conditions of use in ME EQUIPMENT, and they complied with one of the following:	--	P
	a) Applicable safety requirements of a relevant IEC or ISO standard	--	P
	b) Requirements of this standard applied in the absence of a relevant IEC or ISO standard	--	P
4.9	A COMPONENT WITH HIGH-INTEGRITY CHARACTERISTICS provided because a fault in a particular component can generate an unacceptable RISK.....:	See appended Table 8.10 & RM Results Table 4.9 Optocouplers, bridging capacitors.	P
	COMPONENTS WITH HIGH-INTEGRITY CHARACTERISTICS selected and evaluated consistent with their conditions of use and reasonable foreseeable misuse during EXPECTED SERVICE LIFE of ME EQUIPMENT by reviewing RISK MANAGEMENT FILE	See Appended RM Results Table 4.9	N/A
4.10	Power supply		P
4.10.1	ME EQUIPMENT is suitable for connection to a SUPPLY MAINS, specified to be connected to a separate power supply, can be powered by an INTERNAL ELECTRICAL POWER SOURCE, or a combination of the three	Power supply is suitable for connection to supply mains Appliance inlet provided for connection to the mains.	P
4.10.2	Maximum rated voltage for ME EQUIPMENT intended to be connected to SUPPLY MAINS is 250 V for HAND-HELD ME EQUIPMENT (V)	Not hand-held equipment	N/A
	– 250 V d.c. or single-phase a.c., or 500 V polyphase a.c. for ME EQUIPMENT and ME SYSTEMS with a RATED input ≤ 4 kVA (V)	100-240 Vac	P
	– 500 V for all other ME EQUIPMENT and ME SYSTEMS	--	N/A
4.11	Power input		P

IEC 60601-1			
Clause	Requirement + Test	Result - Remark	Verdict
	Steady-state measured input of ME EQUIPMENT or ME SYSTEM at RATED voltage and at operating settings indicated in instructions for use did not exceed marked rating by more than 10% .. :	See appended Table 4.11	P
	– Measurements on ME EQUIPMENT or a ME SYSTEM marked with one or more RATED voltage ranges made at both upper and lower limits of the range	See appended Table 4.11	P
	Measurements made at a voltage equal to the mean value of the range when each marking of RATED input was related to the mean value of relevant voltage range	--	N/A
	Power input, expressed in volt-amperes, measured with a volt-ampere meter or calculated as the product of steady state current (measured as described above) and supply voltage	See appended Table 4.11 Power input expressed in Amperes.	N/A

5	GENERAL REQUIREMENTS FOR TESTING ME EQUIPMENT		P
5.1	TYPE TESTS determined in consideration of Clause 4, in particular 4.2	--	P
	Test not performed when analysis indicated condition being tested was adequately evaluated by other tests or methods	See Appended RM Results Table 5.1	N/A
	Results of RISK ANALYSIS used to determine combination(s) of simultaneous faults to be tested	Applicable single faults performed.	N/A
5.2	TYPE TESTS conducted on one representative sample under investigation; multiple samples used simultaneously when validity of results was not significantly affected	Type test performed on multiple samples. Validity of results not significantly affected.	P
5.3	a) Tests conducted within the environmental conditions specified in technical description	--	P
	Temperature (°C), Relative Humidity (%)	0-55°C Up to 90% RH.	—
	Atmospheric Pressure (kPa)	Atmospheric pressure not influence on the operation of the PSU.	—
	b) ME EQUIPMENT shielded from other influences that might affect the validity of tests	No other influences.	P
	c) Test conditions modified and results adjusted accordingly when ambient temperature could not be maintained	Temperature tests performed in chamber at 55°C ambient temperature.	P

IEC 60601-1			
Clause	Requirement + Test	Result - Remark	Verdict
5.4	a) ME EQUIPMENT tested under least favourable working conditions specified in instructions for use and identified during RISK ANALYSIS, except as noted..... :	See Appended RM Results Table 5.4a Maximum ambient temperature specified by the manufacturer: 55°C. The risk management requirements of the standard were not addressed.	P
	b) ME EQUIPMENT with adjustable or controlled operating values by anyone other than SERVICE PERSONNEL adjusted to values least favourable for the relevant test per instructions for use	No adjustable or controlled operating values provided.	N/A
	c) When test results influenced by inlet pressure and flow or chemical composition of a cooling liquid, tests performed within the limits in technical description..... :	No pressure used.	N/A
	d) Potable water used for cooling	No provision for cooling provided.	N/A
5.5	Supply voltage during tests was the least favourable of the voltages specified in 4.10 or voltages marked on ME EQUIPMENT (V) :	--	P
	ME EQUIPMENT marked with a RATED frequency range tested at the least favourable frequency within the range (Hz) :	Supply frequency: 50-60 Hz	P
	ME EQUIPMENT with more than one RATED voltage, or both a.c./ d.c. tested in conditions (see 5.4) related to the least favourable voltage, nature of supply, and type of current :	Supply voltage: 100-240 Vac Only AC supply voltage used for supplying power supply unit.	P
	ME EQUIPMENT tested with alternative ACCESSORIES and components specified in ACCOMPANYING DOCUMENTS to result in the least favourable conditions :	No such components. No accessories specified by the manufacturer.	P
	ME EQUIPMENT connected to a separate power supply as specified in instructions for use	Mains operated equipment.	N/A
5.6	When failure occurred or probability of future failure detected during sequence of tests, per agreement with manufacturer, all tests affecting results conducted on a new sample	Considered	P
	Alternatively, upon repair and modification of the sample, only the relevant tests conducted	Considered	P

IEC 60601-1			
Clause	Requirement + Test	Result - Remark	Verdict
5.7	ME EQUIPMENT or parts thereof affected by climatic conditions were set up completely, or partially, with covers detached and subjected to a humidity preconditioning prior to tests of Clauses 8.7.4 and 8.8.3..... :	See Appended RM Results Table 5.7 Complete power supply unit was subjected to standard humidity preconditioning treatment (48 hours).	P
	Manually detachable parts removed and treated concurrently with major parts and manually removable ACCESS COVERS were opened and detached	No such parts.	N/A
	ME EQUIPMENT heated to a temperature between T and T + 4 °C for at least 4 h and placed in a humidity chamber with a relative humidity of 93 % ± 3 % and an ambient within 2 °C of T in the range of + 20 °C to + 32 °C for 48 h	Standard humidity treatment performed.	P
	When RISK MANAGEMENT PROCESS indicated ME EQUIPMENT can be exposed to high humidity for extended periods (i.e., out-door use), test time extended proportionally (h) :	See above.	N/A
5.8	Unless stated otherwise, tests in this standard sequenced as in Annex B to prevent results of one test on a subsequent test	Considered.	P
5.9	Determination of APPLIED PARTS and ACCESSIBLE PARTS		P
5.9.1	APPLIED PARTS identified by inspection and reference to ACCOMPANYING DOCUMENTS :	See clause 4.6 Remark No applied parts provided.	N/A
5.9.2	ACCESSIBLE PARTS		N/A
5.9.2.1	Accessibility, when necessary, determined using standard test finger of Fig 6 applied in a bent or straight position	See Appended Table 5.9.2 No openings on the top cover provided. Power supply unit is intended for building-in. End product consideration.	N/A
	Openings preventing entry of test finger of Fig. 6 mechanically tested with a straight un-jointed test finger of the same dimensions with a force of 30 N	Power supply unit is intended for building-in. End product consideration.	N/A
	When the straight un-jointed test finger entered, test with the standard test finger (Fig 6) was repeated, if necessary, by pushing the finger through the opening	Power supply unit is intended for building-in. End product consideration.	N/A
5.9.2.2	Test hook of Fig. 7 inserted in all openings of ME EQUIPMENT and pulled with a force of 20 N for 10 s	Power supply unit is intended for building-in. End product consideration.	N/A

IEC 60601-1			
Clause	Requirement + Test	Result - Remark	Verdict
	All additional parts that became accessible checked using standard test finger and by inspection	--	N/A
5.9.2.3	Conductive parts of actuating mechanisms of electrical controls accessible after removal of handles, knobs, levers and the like regarded as ACCESSIBLE PARTS :	No actuating mechanisms provided.	N/A
	Conductive parts of actuating mechanisms not considered ACCESSIBLE PARTS when removal of handles, knobs, etc. required use of a TOOL, and inspection of RISK MANAGEMENT FILE indicated the relevant part is unlikely to detach unintentionally during EXPECTED SERVICE LIFE of ME EQUIPMENT :	See Appended RM Results Table 5.9.2.3	N/A

6	CLASSIFICATION OF ME EQUIPMENT AND ME SYSTEMS		P
6.2	CLASS I ME EQUIPMENT, externally powered	Class I equipment.	P
	CLASS II ME EQUIPMENT, externally powered	--	N/A
	INTERNALLY POWERED ME EQUIPMENT	EUT under test is not internally powered.	N/A
	EQUIPMENT with means of connection to a SUPPLY MAINS complied with CLASS I or CLASS II ME EQUIPMENT requirements when so connected, and when not connected to SUPPLY MAINS with INTERNALLY POWERED ME EQUIPMENT requirements	Not internally powered equipment. EUT is intended for connection to the mains.	N/A
	TYPE B APPLIED PART	No applied parts provided.	N/A
	TYPE BF APPLIED PART	--	N/A
	TYPE CF APPLIED PART	--	N/A
	DEFIBRILLATION-PROOF APPLIED PARTS	--	N/A
6.3	ENCLOSURES classified according to degree of protection against ingress of water and particulate matter (IPN ₁ N ₂) as per IEC 60529 :	See RM Results Table 11.6.5. EUT does not have final enclosure. Protection against ingress of water and dust is subject to end product investigation.	N/A
6.4	ME EQUIPMENT or its parts intended to be sterilized classified according to method(s) of sterilization in instructions for use :	No such parts.	N/A
6.5	ME EQUIPMENT and ME SYSTEMS intended for use in an OXYGEN RICH ENVIRONMENT classified for such use and complied with 11.2.2	EUT was not evaluated for use in oxygen rich environments.	N/A

IEC 60601-1			
Clause	Requirement + Test	Result - Remark	Verdict
6.6	CONTINUOUS or Non-CONTINUOUS OPERATION :	Power supply unit is designed for continuous operation. No markings provided on the outer side of enclosure.	P

7	ME EQUIPMENT IDENTIFICATION, MARKING, AND DOCUMENTS		P
7.1.1	RISK of poor USABILITY associated with the design of ME EQUIPMENT'S identification and marking addressed in a USABILITY ENGINEERING PROCESS..... :	EUT is medical power supply unit for building in. Identification and markings are provided on the marking plate. Usability is not associated with the EUT since it is subject to end product investigation.	N/A
7.1.2	Legibility of Markings Test for Markings specified in Clause 7.2-7.6..... :	See Appended Table 7.1.2 Power supply unit is intended for building-in. Marking plate shall not be visible after installation within the end medical product.	N/A
7.1.3	Required markings can be removed only with a TOOL or by appreciable force, are durable and remain CLEARLY LEGIBLE during EXPECTED SERVICE LIFE of ME EQUIPMENT in NORMAL USE	--	P
	a) After tests, adhesive labels didn't loosen up or curl up at edges and markings complied with requirements in Clause 7.1.2..... :	See appended Tables 7.1.3 and 8.10	P
	b) Markings required by 7.2-7.6 remained CLEARLY LEGIBLE after marking durability test ... :	See appended Tables 7.1.3 and 8.10	P
7.2	Marking on the outside of ME EQUIPMENT or ME EQUIPMENT parts		P
7.2.1	At least markings in 7.2.2, 7.2.5, 7.2.6 (not for PERMANENTLY INSTALLED ME EQUIPMENT), 7.2.10, and 7.2.13 were applied when size of EQUIPMENT, its part, an ACCESSORY, or ENCLOSURE did not permit application of all required markings :	See attached copy of Marking Plate All required markings are provided on the marking plate.	P
	Remaining markings fully recorded in ACCOMPANYING DOCUMENTS :	See above.	N/A
	Markings applied to individual packaging when impractical to apply to ME EQUIPMENT	Packaging not part of investigation.	N/A

IEC 60601-1			
Clause	Requirement + Test	Result - Remark	Verdict
	A material, component, ACCESSORY, or ME EQUIPMENT intended for a single use, or its packaging marked "Do Not Reuse" or with symbol 28 of Table D.1 (ISO 7000-1051, DB:2004-01)	No such material, component, accessory or equipment parts intended for single use.	N/A
7.2.2	MANUFACTURER's name or trademark marked on ME EQUIPMENT and detachable components	Provided.	P
	Misidentification does not present an unacceptable risk	See Appended RM Results Table 7.2.2	P
	MODEL OR TYPE REFERENCE also marked, except when misidentification would not present an unacceptable RISK	See attached copy of Marking Plate	P
	Software forming part of a PEMS identified with a unique identifier, such as revision level or date of release/issue, and identification are available to designated persons	No software incorporated. EUT is medical in power supply unit.	N/A
7.2.3	Symbol 11 on Table D.1 (ISO 7000-1641, DB: 2004-01) used, optionally, advice to OPERATOR to consult ACCOMPANYING DOCUMENTS	Power supply unit is intended for building-in; therefore symbol not required.	N/A
	Safety sign 10 on Table D.2 (safety sign IEC 60878 Safety 01) used, advising OPERATOR that ACCOMPANYING DOCUMENTS must be consulted	--	N/A
7.2.4	ACCESSORIES marked with name or trademark of MANUFACTURER or supplier, and with a MODEL or TYPE REFERENCE	No accessories provided.	N/A
	Markings applied to individual packaging when not practical to apply to ACCESSORIES	--	N/A
7.2.5	MODEL OR TYPE REFERENCE of equipment to be connected to ME EQUIPMENT to provide power, is marked adjacent to the relevant connection point when this connection could result in an unacceptable RISK.....	See Appended RM Results Table 7.2.5 Mains operated equipment.	N/A
7.2.6	Connection to the Supply Mains		P
	Except for PERMANENTLY INSTALLED ME EQUIPMENT, marking appearing on the outside of part containing SUPPLY MAINS connection and, adjacent to connection point	All relevant information provided on the marking plate. Power supply unit is intended for building-in.	P
	For PERMANENTLY INSTALLED ME EQUIPMENT, NOMINAL supply voltage or range marked inside or outside of ME EQUIPMENT, preferably, adjacent to supply connection terminals	EUT is not permanently installed equipment.	N/A
	- RATED supply voltage(s) or RATED voltage range(s) with a hyphen (-) between minimum and maximum voltages (V, V-V)	100-240 Vac Marking provided on the marking plate.	P

IEC 60601-1			
Clause	Requirement + Test	Result - Remark	Verdict
	Multiple RATED supply voltages or multiple RATED supply voltage ranges are separated by (V/V)....:	--	N/A
	– Nature of supply (e.g., No. of phases, except single-phase) and type of current	Symbol “ ~ ” provided near rated supply voltage.	P
	Symbols 1-5, Table D.1 (symbols of IEC 60417-5032, 5032-1, 5032-2, 5031, and 5033, all DB: 2002-10) used, optionally, for same parameters:	Symbol No. 1 from table D.1 used for input voltage.	P
	– RATED supply frequency or RATED frequency range in hertz.....:	50-60 Hz	P
	– Symbol 9 of Table D.1 (symbol IEC 60417-5172, DB: 2003-02) used for CLASS II ME EQUIPMENT	Class I equipment.	N/A
7.2.7	RATED input in amps or volt-amps, or in watts when power factor exceeds 0.9 (A, VA, W).....:	Rated input expressed in Amperes.	P
	RATED input for one or more RATED voltage ranges provided for upper and lower limits of the range or ranges when the range(s) is/are greater than ± 10 % of the mean value of specified range (A, VA,W).....:	Rated input expressed in Amperes for lower and upper voltage range:	P
	Input at mean value of range marked when range limits do not differ by more than 10 % from mean value (A, VA, W)	--	N/A
	Marking includes long-time and most relevant momentary volt-ampere ratings when provided, each plainly identified and indicated in ACCOMPANYING DOCUMENTS (VA).....:	--	N/A
	Marked input of ME EQUIPMENT provided with means for connection of supply conductors of other electrical equipment includes RATED and marked output of such means (A, VA, W)	--	N/A
7.2.8	Output connectors		P
7.2.8.1	See 16.9.2.1 b) for MULTIPLE SOCKET-OUTLETS integral with ME EQUIPMENT	--	N/A
7.2.8.2	Output connectors are marked, except for MULTIPLE SOCKET-OUTLETS or connectors intended for specified ACCESSORIES or equipment	Output ratings provided on the marking plate.	P
	Rated Voltage (V), Rated Current (A).....:	See copy of marking plate for details.	—
	Rated Power (W), Output Frequency (Hz)	--	—
7.2.9	ME EQUIPMENT or its parts marked with the IP environmental Code per IEC 60529 according to classification in 6.3 (Table D.3, Code 2).....:	Power supply unit is intended for building-in. End product consideration.	N/A
7.2.10	Degrees of protection against electric shock as classified in 6.2 for all APPLIED PARTS marked with relevant symbols as follows (not applied to parts identified according to 4.6):	No applied parts provided.	N/A

IEC 60601-1			
Clause	Requirement + Test	Result - Remark	Verdict
	TYPE B APPLIED PARTS with symbol 19 of Table D.1 (IEC 60417-5840, DB: 2002-10), not applied in such a way as to give the impression of being inscribed within a square in order to distinguish it from symbol IEC 60417-5333	--	N/A
	TYPE BF APPLIED PARTS with symbol 20 of Table D.1 (IEC 60417-5333, DB: 2002-10)	--	N/A
	TYPE CF APPLIED PARTS with symbol 21 of Table D.1 (IEC 60417-5335, DB: 2002-10)	--	N/A
	DEFIBRILLATION-PROOF APPLIED PARTS marked with symbols 25-27 of Table D.1 (IEC 60417-5841, IEC 60417-5334, or IEC 60417-5336, all DB: 2002-10):	--	N/A
	Proper symbol marked adjacent to or on connector for APPLIED PART, except marked on APPLIED PART when there is no connector, or connector used for more than one APPLIED PART and different APPLIED PARTS with different classifications	--	N/A
	Safety sign 2 of Table D.2 (ISO 7010-W001) placed near relevant outlet when protection against effect of discharge of a cardiac defibrillator is partly in the PATIENT cable	--	N/A
	An explanation indicating protection of ME EQUIPMENT against effects of discharge of a cardiac defibrillator depends on use of proper cables included in instructions for use	--	N/A
7.2.11	ME EQUIPMENT not marked to the contrary assumed to be suitable for CONTINUOUS OPERATION	EUT intended for continuous operation.	N/A
	DUTY CYCLE for ME EQUIPMENT intended for non-CONTINUOUS OPERATION appropriately marked to provide maximum "on" and "off" time	--	N/A
7.2.12	Type and full rating of a fuse marked adjacent to ACCESSIBLE fuse-holder	External accessible fuses marked near approved appliance inlet. Fuses are incorporated within approved appliance inlet. See enclosed pictures of the unit for details.	P
	Fuse type	T4AH 250 Vac Provided above fuse holder.	—
	Voltage (V) and Current (A) rating	T4AH 250 Vac Provided above fuse holder.	—
	Operating speed (s) and Breaking capacity	T4AH 250 Vac Provided above fuse holder.	—

IEC 60601-1			
Clause	Requirement + Test	Result - Remark	Verdict
7.2.13	A safety sign CLEARLY LEGIBLE and visible after INSTALLATION in NORMAL USE applied to a prominent location of EQUIPMENT that produce physiological effects capable of causing HARM to PATIENT or OPERATOR not obvious to OPERATOR ...:	EUT produces no physiological effect.	N/A
	Nature of HAZARD and precautions for avoiding or minimizing the associated RISK described in instructions for use	See Appended RM Results Table 7.2.13	N/A
7.2.14	HIGH VOLTAGE TERMINAL DEVICES on the outside of ME EQUIPMENT accessible without the use of a TOOL marked with symbol 24 of Table D.1 (symbol IEC 60417-5036, DB: 2002-10)	No such terminals.	N/A
7.2.15	Requirements for cooling provisions marked (e.g., supply of water or air).....:	--	N/A
7.2.16	ME EQUIPMENT with limited mechanical stability	Unit for building-in.	N/A
7.2.17	Packaging marked with special handling instructions for transport and/or storage.....:	--	N/A
	Permissible environmental conditions for transport and storage marked on outside of packaging	--	N/A
	Packaging marked with a suitable safety sign indicating premature unpacking of ME EQUIPMENT could result in an unacceptable RISK	See Appended RM Results Table 7.2.17	N/A
	Packaging of sterile ME EQUIPMENT or ACCESSORIES marked sterile	--	N/A
7.2.18	RATED maximum supply pressure from an external source marked on ME EQUIPMENT adjacent to each input connector.....:	--	N/A
7.2.19	Symbol 7 of Table D.1 (IEC 60417-5017, DB:2002-10) marked on FUNCTIONAL EARTH TERMINAL.....:	No functional earth terminal provided.	N/A
7.2.20	Protective means, required to be removed to use a particular function of ME EQUIPMENT with alternate applications, marked to indicate the necessity for replacement when the function is no longer needed	--	N/A
	No marking applied when an interlock provided	--	N/A
7.3	Marking on the inside of ME EQUIPMENT or ME EQUIPMENT parts		P
7.3.1	Maximum power loading of heating elements or lamp-holders designed for use with heating lamps marked near or in the heater (W)	No heating elements provided.	N/A
	A marking referring to ACCOMPANYING DOCUMENTS provided for heating elements or lamp-holders designed for heating lamps that can be changed only by SERVICE PERSONNEL using a TOOL	--	N/A

IEC 60601-1			
Clause	Requirement + Test	Result - Remark	Verdict
7.3.2	Symbol 24 of Table D.1 (symbol IEC 60417-5036, DB: 2002-10), or safety sign 3 of Table D.2 used to mark presence of HIGH VOLTAGE parts..... :	No such parts.	N/A
7.3.3	Type of battery and mode of insertion when applicable is marked..... :	No batteries provided.	N/A
	An identifying marking provided referring to instructions in ACCOMPANYING DOCUMENTS for batteries intended to be changed only by SERVICE PERSONNEL using a TOOL :	--	N/A
	A warning provided indicating replacement of lithium batteries or fuel cells when incorrect replacement by inadequately trained personnel would result in an unacceptable RISK (e.g., excessive temperatures, fire or explosion) :	--	N/A
	An identifying marking also provided referring to instructions in ACCOMPANYING DOCUMENTS..... :	See Appended RM Results Table 7.3.3	N/A
7.3.4	Fuses, replaceable THERMAL CUT-OUTS and OVER-CURRENT RELEASES, accessible by use of a TOOL, marked by type and full rating at the component or by reference to ACCOMPANYING DOCUMENTS	External accessible fuses marked near appliance inlet. Fuses are incorporated within approved appliance inlet.	P
	Type :	T4AH 250 Vac	—
	Voltage (V) and Current (A) rating..... :	T4AH 250 Vac	—
	Operating speed (s) and Breaking capacity..... :	T4AH 250 Vac	—
7.3.5	PROTECTIVE EARTH TERMINAL marked with symbol 6 of Table D.1 (IEC 60417-5019, DB: 2002-10), except for the PROTECTIVE EARTH TERMINAL in an APPLIANCE INLET according to IEC 60320-1	Protective earth terminal is part of approved appliance inlet. Symbol number 6 of Table D.1 provided on the appliance inlet enclosure.	N/A
	Markings on or adjacent to PROTECTIVE EARTH TERMINALS not applied to parts requiring removal to make the connection, and remained visible after connection made	--	N/A
7.3.6	Symbol 7 of Table D.1 (IEC 60417-5017, DB: 2002 -10) marked on FUNCTIONAL EARTH TERMINALS	No functional earth.	N/A
7.3.7	Terminals for supply conductors marked adjacent to terminals, except when no HAZARD would result when interchanging connections	See Appended RM Results Table 7.3.7	N/A
	Terminal markings included in ACCOMPANYING DOCUMENTS when ME EQUIPMENT too small to accommodate markings	--	N/A
	Terminals exclusively for neutral supply conductor in PERMANENTLY INSTALLED ME EQUIPMENT marked with Code 1 of Table D.3 (Code in IEC 60445)	EUT intended for building-in	N/A

IEC 60601-1			
Clause	Requirement + Test	Result - Remark	Verdict
	Marking for connection to a 3-phase supply, if necessary, complies with IEC 60445	Single phase connection.	N/A
	Markings on or adjacent to electrical connection points not applied to parts requiring removal to make connection, and remained visible after connection made	--	N/A
7.3.8	“For supply connections, use wiring materials suitable for at least X °C” (where X > than max temperature measured in terminal box or wiring compartment under NORMAL USE), or equivalent, marked at the point of supply connections	End product consideration.	N/A
	Statement not applied to parts requiring removal to make the connection, and CLEARLY LEGIBLE after connections made	--	N/A
7.4	Marking of controls and instruments		P
7.4.1	The “on” & “off” positions of switch to control power to ME EQUIPMENT or its parts, including mains switch, marked with symbols 12 and 13 of Table D.1 (IEC 60417-5007, DB: 2002-10, and IEC 60417-5008, DB: 2002-10), or	Mains switch provided on the outer side of the metal enclosure marked with symbols 12 and 13 of Table D.1 See enclosed pictures of the unit for details.	P
	– indicated by an adjacent indicator light, or	--	N/A
	– indicated by other unambiguous means	--	N/A
	The “on/off” positions of push button switch with bi-stable positions marked with symbol 14 of Table D.1 (IEC 60417-5010 DB: 2002-10), and	No push buttons provided.	N/A
	– status indicated by adjacent indicator light	--	N/A
	– status indicated by other unambiguous means	--	N/A
	The “on/off” positions of push button switch with momentary on position marked with symbol 15 of Table D.1 (symbol 60417-5011 DB: 2002-10), or	--	N/A
	– status indicated by adjacent indicator light	--	N/A
	– status indicated by other unambiguous means	--	N/A
7.4.2	Different positions of control devices/switches indicated by figures, letters, or other visual means	No control devices provided.	N/A
	Controls provided with an associated indicating device when change of setting of a control could result in an unacceptable RISK to PATIENT in NORMAL USE, or	See Appended RM Results Table 7.4.2	N/A
	– an indication of direction in which magnitude of the function changes	--	N/A

IEC 60601-1			
Clause	Requirement + Test	Result - Remark	Verdict
7.4.3	Numeric indications of parameters on ME EQUIPMENT expressed in SI units according to ISO 31 except the base quantities listed in Table 1 expressed in the indicated units	--	N/A
	ISO 1000 applied for application of SI units, their multiples, and certain other units	--	N/A
	All Markings in Sub-clause 7.4 complied with tests and criteria of 7.1.2 and 7.1.3	See Appended Tables 7.1.2 and 7.1.3.	N/A
7.5	Safety signs		N/A
	Markings used to convey a warning, prohibition or mandatory action mitigating a RISK not obvious to OPERATOR are safety signs from ISO 7010	See Appended RM Results Table 7.5 No safety signs provided. EUT is power supply unit intended for building-in.	N/A
	Affirmative statement together with safety sign placed in instructions for use if insufficient space on ME EQUIPMENT	--	N/A
	Specified colours in ISO 3864-1 used for safety signs.....:	--	N/A
	Safety notices include appropriate precautions or instructions on how to reduce RISK(S)	--	N/A
	Safety signs including any supplementary text or symbols described in instructions for use	--	N/A
7.6	Symbols		P
7.6.1	Meanings of symbols used for marking described in instructions for use.....:	Symbols described within technical specifications provided by the manufacturer.	P
7.6.2	Symbols required by this standard conform to IEC or ISO publication referenced	According to Annex D.	P
7.6.3	Symbols used for controls and performance conform to the IEC or ISO publication where symbols are defined, as applicable	--	N/A
7.7	Colours of the insulation of conductors		P
7.7.1	PROTECTIVE EARTH CONDUCTOR identified by green and yellow insulation	Protective earth conductor provided from approved appliance inlet to enclosure with green/yellow colour of insulation.	P
7.7.2	Insulation on conductors inside ME EQUIPMENT forming PROTECTIVE EARTH CONNECTIONS identified by green and yellow at least at terminations	Protective earth conductor provided from approved appliance inlet to enclosure with green/yellow colour of insulation.	N/A

IEC 60601-1			
Clause	Requirement + Test	Result - Remark	Verdict
7.7.3	Green and yellow insulation identify only following conductors:	Protective earth conductor provided from approved appliance inlet to enclosure.	P
	– PROTECTIVE EARTH CONDUCTORS	--	P
	– conductors specified in 7.7.2	--	P
	– POTENTIAL EQUALIZATION CONDUCTORS	Potential equalization terminal fixed directly to the metal enclosure.	N/A
	– FUNCTIONAL EARTH CONDUCTORS	No functional earth provided.	N/A
7.7.4	Neutral conductors of POWER SUPPLY CORDS are “light blue” specified in IEC 60227-1 or IEC 60245-1	Power supply cord not part of investigation.	N/A
7.7.5	Colours of conductors in POWER SUPPLY CORDS in accordance with IEC 60227-1 or IEC 60245-1	--	N/A
7.8	Indicator lights and controls		N/A
7.8.1	Red indicator lights mean: Warning (i.e., immediate response by OPERATOR required)	No indicator lights provided. Power supply unit is intended for building-in.	N/A
	Yellow indicator lights mean: Caution (i.e., prompt response by OPERATOR required)	--	N/A
	Green indicator lights mean: Ready for use	--	N/A
	Other colours, if used: Meaning other than red, yellow, or green (colour, meaning)	--	N/A
7.8.2	Red used only for emergency control	--	N/A
7.9	ACCOMPANYING DOCUMENTS		P
7.9.1	ME EQUIPMENT accompanied by documents containing at least instructions for use, and a technical description	Technical specifications provided by the manufacturer.	P
	ACCOMPANYING DOCUMENTS identify ME EQUIPMENT by the following, as applicable:	--	P
	– Name or trade-name of MANUFACTURER and an address the RESPONSIBLE ORGANIZATION can be referred to	Provided within technical specifications.	P
	– MODEL or TYPE REFERENCE	Model name provided within technical specifications.	P
	When ACCOMPANYING DOCUMENTS provided electronically (e.g., on CDROM), RISK MANAGEMENT PROCESS includes instructions as to what is required in hard copy or as markings on ME EQUIPMENT (for emergency operation)	See Appended RM Results Table 7.9.1 Paper version provided by the manufacturer.	N/A

IEC 60601-1			
Clause	Requirement + Test	Result - Remark	Verdict
	ACCOMPANYING DOCUMENTS specify special skills, training, and knowledge required of OPERATOR or RESPONSIBLE ORGANIZATION and environmental restrictions on locations of use	Power supply unit is intended for building-in.	P
	ACCOMPANYING DOCUMENTS written at a level consistent with education, training, and other needs of individuals for whom they are intended	Power supply unit is intended for building-in.	P
7.9.2	Instructions for use include the required information		P
7.9.2.1	– intended use of ME EQUIPMENT,	EUT is medical in power supply unit for building in, intended for supplying end medical product by supplying its output voltage.	P
	– frequently used functions, and	EUT is medical in power supply unit for building in, intended for supplying end medical product by supplying its output voltage.	N/A
	– known contraindication(s) to use of ME EQUIPMENT	No contraindications.	N/A
	Classifications as in Clause 6, all markings per Clause 7.2, and explanation of safety signs and symbols marked on ME EQUIPMENT	Provided within technical specifications.	P
	Instructions for use are in a language acceptable to the intended operator	English version evaluated.	P
7.9.2.2	Instructions for use include all warning and safety notices	Provided within user instructions.	P
	Warning statement for CLASS I ME EQUIPMENT indicating: “WARNING: To avoid risk of electric shock, this equipment must only be connected to a supply mains with protective earth”	Class I equipment. EUT is for building in. Connection to the mains shall be investigated within the end product. Warning note is end product consideration.	N/A
	Warnings regarding significant RISKS of reciprocal interference posed by ME EQUIPMENT during specific investigations or treatments	--	N/A
	Information on potential electromagnetic or other interference and advice on how to avoid or minimize such interference	--	N/A
	Warning statement for ME EQUIPMENT supplied with an integral MULTIPLE SOCKET-OUTLET indicating, “connecting electrical equipment to MSO effectively leads to creating an ME SYSTEM, and can result in a reduced level of safety”	Mains operated equipment.	N/A

IEC 60601-1			
Clause	Requirement + Test	Result - Remark	Verdict
	The RESPONSIBLE ORGANIZATION is referred to this standard for the requirements applicable to ME SYSTEMS	--	N/A
7.9.2.3	Statement on ME EQUIPMENT for connection to a separate power supply indicating "power supply is specified as a part of ME EQUIPMENT or combination is specified as a ME SYSTEM"	Mains operated equipment.	N/A
7.9.2.4	Warning statement for mains- operated ME EQUIPMENT with additional power source not automatically maintained in a fully usable condition indicating the necessity for periodic checking or replacement of power source	No additional power source provided.	N/A
	Warning to remove primary batteries when ME EQUIPMENT is not likely to be used for some time when leakage from battery would result in an unacceptable RISK..... :	See Appended RM Results Table 7.9.2.4	N/A
	Specifications of replaceable INTERNAL ELECTRICAL POWER SOURCE when provided	--	N/A
	Warning indicating ME EQUIPMENT must be connected to an appropriate power source when loss of power source would result in an unacceptable RISK..... :	See Appended RM Results Table 7.9.2.4	N/A
7.9.2.5	Instructions for use include a description of ME EQUIPMENT, its functions, significant physical and performance characteristics together with the expected positions of OPERATOR, PATIENT, or other persons near ME EQUIPMENT in NORMAL USE	Power supply unit is intended for building-in. End product consideration.	N/A
	Information provided on materials and ingredients PATIENT or OPERATOR is exposed to when such exposure can constitute an unacceptable RISK	--	N/A
	Restrictions specified on other equipment or NETWORK/DATA COUPLINGS, other than those forming part of an ME SYSTEM, to which a SIGNAL INPUT/OUTPUT PART may be connected	--	N/A
	APPLIED PARTS specified	No applied parts.	N/A
7.9.2.6	Information provided indicating where the installation instructions may be found or information on qualified personnel who can perform the installation	--	N/A
7.9.2.7	Instructions provided indicating not to position ME EQUIPMENT to make it difficult to operate the disconnection device when an APPLIANCE COUPLER or separable plug is used as isolation means to meet 8.11.1 a)	EUT intended for building-in.	N/A

IEC 60601-1			
Clause	Requirement + Test	Result - Remark	Verdict
7.9.2.8	Necessary information provided for OPERATOR to bring ME EQUIPMENT into operation including initial control settings, and connection to or positioning of PATIENT prior to use of ME EQUIPMENT, its parts, or ACCESSORIES	--	N/A
7.9.2.9	Information provided to operate ME EQUIPMENT including explanation of controls, displays and signals, sequence of operation, connection of detachable parts or ACCESSORIES, replacement of material consumed during operation	No such parts.	N/A
	Meanings of figures, symbols, warning statements, abbreviations and indicator lights described in instructions for use	--	N/A
7.9.2.10	A list of all system messages, error messages, and fault messages provided with an explanation of messages including important causes and possible action(s) to be taken to resolve the problem indicated by the message	No messages provided.	N/A
7.9.2.11	Information provided for the OPERATOR to safely terminate operation of ME EQUIPMENT	Termination of the ME equipment shall be investigated within the end product.	N/A
7.9.2.12	Information provided on cleaning, disinfection, and sterilization methods, and applicable parameters that can be tolerated by ME EQUIPMENT parts or ACCESSORIES specified	EUT is maintenance free.	N/A
	Components, ACCESSORIES or ME EQUIPMENT marked for single use, except when required by MANUFACTURER to be cleaned, disinfected, or sterilized prior to use	--	N/A
7.9.2.13	Instructions provided on preventive inspection, calibration, maintenance and its frequency	EUT is maintenance free.	N/A
	Information provided for safe performance of routine maintenance necessary to ensure continued safe use of ME EQUIPMENT	--	N/A
	Parts requiring preventive inspection and maintenance to be performed by SERVICE PERSONNEL identified including periods of application	No such parts specified by the manufacturer.	N/A
	Instructions provided to ensure adequate maintenance of ME EQUIPMENT containing rechargeable batteries to be maintained by anyone other than SERVICE PERSONNEL	No rechargeable batteries incorporated.	N/A
7.9.2.14	A list of ACCESSORIES, detachable parts, and materials for use with ME EQUIPMENT provided	No such parts.	N/A
	Other equipment providing power to ME SYSTEM sufficiently described (e.g. part number, RATED VOLTAGE, max or min power, protection class, intermittent or continuous service)	Mains operated equipment.	N/A

IEC 60601-1			
Clause	Requirement + Test	Result - Remark	Verdict
7.9.2.15	RISKS associated with disposal of waste products, residues, etc., and of ME EQUIPMENT and ACCESSORIES at the end of their EXPECTED SERVICE LIFE are identified, and instructions provided on minimizing these RISKS	Provided within technical specifications.	P
7.9.2.16	Instructions for use include information specified in 7.9.3 or identify where it can be found (e.g. in a service manual)	Provided within technical specifications.	P
7.9.3	Technical description		P
7.9.3.1	All essential data provided for safe operation, transport, storage, and measures or conditions necessary for installing ME EQUIPMENT, and preparing it for use including the following:		P
	– information as in clause 7.2	Provided within technical specification provided by the manufacturer.	P
	– permissible environmental conditions of use including conditions for transport and storage	Operating conditions: 0 to 55°C temperature 5 to 95% humidity Storage conditions: -20°C to 70°C temperature 5 to 95% humidity	P
	– all characteristics of ME EQUIPMENT including range(s), accuracy, and precision of displayed values or where they can be found	--	N/A
	– special installation requirements such as max. permissible apparent impedance of SUPPLY MAINS	Not specified.	N/A
	– permissible range of values of inlet pressure and flow, and chemical composition of cooling liquid used for cooling	No pressure used.	N/A
	– a description of means of isolating ME EQUIPMENT from SUPPLY MAINS, when such means not in ME EQUIPMENT	Power supply unit is intended for building-in. End product consideration.	N/A
	– a description of means for checking oil level in partially sealed oil filled ME EQUIPMENT or its parts when applicable	--	N/A
	– a warning statement addressing HAZARDS that can result from unauthorized modification of ME EQUIPMENT according to following examples	Statement shall be provided within the end product documentation: A modification of the power supply unit or ME equipment is not allowed. Modification itself is not applicable to the component level of the power supply.	N/A

IEC 60601-1			
Clause	Requirement + Test	Result - Remark	Verdict
	“WARNING: No modification of this equipment is allowed”	--	N/A
	“WARNING: Do not modify this equipment without authorization of the manufacturer”	--	N/A
	“WARNING: If this equipment is modified, appropriate inspection and testing must be conducted to ensure continued safe use of equipment”	--	N/A
	Technical description separable from instructions for use contains required information, as follows		N/A
	– information as in clause 7.2	Only technical specification provided by the manufacturer. No instruction for use provided due the power supply unit is intended for building-in.	N/A
	– all applicable classifications in Clause 6, warning and safety notices, and explanation of safety signs marked on ME EQUIPMENT	--	N/A
	– a brief description of ME EQUIPMENT, how it functions, and its significant physical and performance characteristics	--	N/A
	MANUFACTURER’S optional requirements for minimum qualifications of SERVICE PERSONNEL documented in technical description	--	N/A
7.9.3.2	The technical description contains the following required information		P
	–type and full rating of fuses used in SUPPLY MAINS external to PERMANENTLY INSTALLED ME EQUIPMENT, when type and rating of fuses are not apparent from information on RATED current and mode of operation of ME EQUIPMENT	See Appended RM Results Table 7.9.3.2 EUT is not permanently installed equipment.	P
	– a statement for ME EQUIPMENT with a non-DETACHABLE POWER SUPPLY CORD if POWER SUPPLY CORD is replaceable by SERVICE PERSONNEL, and if so, instructions for correct connection and anchoring to ensure compliance with 8.11.3	EUT is provided with appliance inlet used for connection the mains.	N/A
	– instructions for correct replacement of interchangeable or detachable parts specified by MANUFACTURER as replaceable by SERVICE PERSONNEL, and	No such parts.	N/A
	– warnings identifying nature of HAZARD when replacement of a component could result in an unacceptable RISK, and when replaceable by SERVICE PERSONNEL all information necessary to safely replace the component	--	N/A

IEC 60601-1			
Clause	Requirement + Test	Result - Remark	Verdict
7.9.3.3	Technical description indicates, MANUFACTURER will provide circuit diagrams, component part lists, descriptions, calibration instructions to assist to SERVICE PERSONNEL in parts repair	Provided within technical specifications.	P
7.9.3.4	Means used to comply with requirements of 8.11.1 clearly identified in technical description	Power supply unit is intended for building-in. End product consideration.	N/A

8	PROTECTION AGAINST ELECTRICAL HAZARDS FROM ME EQUIPMENT		P
8.1	Limits specified in Clause 8.4 not exceeded for ACCESSIBLE PARTS and APPLIED PARTS in NORMAL or SINGLE FAULT CONDITIONS	--	P
	NORMAL CONDITION considered as simultaneous occurrence of situations identified in 8.1a)	--	P
	SINGLE FAULT CONDITION considered to include the occurrences as specified in Clause 8.1b)... :	See Appended RM Results Tables 8.1b(1), (2), (3)	N/A
	ACCESSIBLE PARTS determined according to 5.9	--	N/A
	LEAKAGE CURRENTS measured according to 8.7	--	P
8.2	Requirements related to power sources		N/A
8.2.1	When ME EQUIPMENT specified for connection to a separate power source other than SUPPLY MAINS, separate power source considered as part of ME EQUIPMENT or combination considered as an ME SYSTEM	EUT is intended for connection to the mains.	N/A
	Tests performed with ME EQUIPMENT connected to separate power supply when one specified	--	N/A
	When a generic separate power supply specified, specification in ACCOMPANYING DOCUMENTS examined	--	N/A
8.2.2	No HAZARDOUS SITUATION other than absence of ESSENTIAL PERFORMANCE developed when a connection with wrong polarity made for ME EQUIPMENT from an external d.c. source	See Appended RM Results Table 8.2.2	N/A
	ME EQUIPMENT connected with correct polarity did not present an unacceptable RISK	--	N/A
	Protective devices that can be reset by anyone without a TOOL restore correct operation on reset	--	N/A
8.3	Classification of APPLIED PARTS		N/A
	a) APPLIED PART specified in ACCOMPANYING DOCUMENTS as suitable for DIRECT CARDIAC APPLICATION is TYPE CF	No applied parts provided.	N/A

IEC 60601-1			
Clause	Requirement + Test	Result - Remark	Verdict
	b) An APPLIED PART provided with a PATIENT CONNECTION intended to deliver electrical energy or an electrophysiological signal to or from PATIENT is TYPE BF OR CF APPLIED PART	--	N/A
	c) An APPLIED PART not covered by a) or b) is a TYPE B, BF, or CF	--	N/A
	d) Requirements of a TYPE B APPLIED PART applied to a part in 4.6 to be subjected to requirements for an APPLIED PART (except marking)	--	N/A
	Requirements for a TYPE BF or CF APPLIED PART applied as in RISK MANAGEMENT PROCESS	See Appended RM Results Table 8.3d	N/A
8.4	Limitation of voltage, current or energy		P
8.4.1	PATIENT CONNECTIONS intended to deliver Current		N/A
	Limits in 8.4.2 not applied to currents intended to flow through body of PATIENT to produce a physiological effect during NORMAL USE	No patient connection.	N/A
8.4.2	ACCESSIBLE PARTS including APPLIED PARTS		P
	a) Currents from, to, or between PATIENT CONNECTIONS did not exceed limits for PATIENT LEAKAGE CURRENT and PATIENT AUXILIARY CURRENT per Tables 3 and 4 when measured according to Clause 8.7.4	See appended Table 8.7	N/A
	b) LEAKAGE CURRENTS from, to, or between ACCESSIBLE PARTS did not exceed limits for TOUCH CURRENT in Cl. 8.7.3 c) when measured per Clause 8.7.4 (mA)	See appended Table 8.7 Power supply unit is intended for building-in with protectively earthed own metal. Enclosure not accessible after installation within the end medical product. Equipment provides five outputs. Those outputs shall not be accessible by the user and are only used for supplying end medical product by its output voltages.	N/A
	c) Limits specified in b) not applied to parts when probability of a connection to a PATIENT, directly or through body of OPERATOR, is negligible in NORMAL USE, and the OPERATOR is appropriately instructed	See Appended RM Results Table 8.4.2c	N/A
	- accessible contacts of connectors	--	N/A
	- contacts of fuseholders accessible during replacement of fuse	--	N/A

IEC 60601-1			
Clause	Requirement + Test	Result - Remark	Verdict
	– contacts of lampholders accessible after removal of lamp	--	N/A
	– parts inside an ACCESS COVER that can be opened without a TOOL, or where a TOOL is needed but the instructions for use instruct an OPERATOR other than SERVICE PERSONNEL to open the relevant ACCESS COVER	--	N/A
	Voltage to earth or to other ACCESSIBLE PARTS did not exceed 42.4 V peak a.c. or 60 V d.c. for above parts in NORMAL or single fault condition (V a.c. or d.c.)	See appended Table 8.4.2 Equipment provides five outputs. Those outputs shall not be accessible by the user and are only used for supplying end medical product by its output voltages. Measurements performed only for reference.	P
	Limit of 60 V d.c. applied with no more than 10% peak-to-peak ripple, and when ripple larger than specified value, 42.4 V peak limit applied (V d.c.)	See appended Table 8.4.2 Equipment provides five outputs. Those outputs shall not be accessible by the user and are only used for supplying end medical product by its output voltages. Measurements performed only for reference	P
	Energy did not exceed 240 VA for longer than 60 s or stored energy available did not exceed 20 J at a potential up to 2 V (VA or J)	See appended Table 8.4.2 Equipment provides five outputs. Those outputs shall not be accessible by the user and are only used for supplying end medical product by its output voltages. Measurements performed only for reference	P
	LEAKAGE CURRENT limits referred to in 8.4.2 b) applied when voltages higher than limits in 8.4.2 c) were present (mA)	See appended Table 8.4.2	N/A
	d) Voltage and energy limits specified in c) above also applied to the following:	--	N/A
	– internal parts, other than contacts of plugs, connectors and socket-outlets, touchable by test pin in Fig 8 inserted through an opening in an ENCLOSURE; and	--	N/A

IEC 60601-1			
Clause	Requirement + Test	Result - Remark	Verdict
	– internal parts touchable by a metal test rod with a diameter of 4 mm and a length of 100 mm, inserted through any opening on top of ENCLOSURE or through any opening provided for adjustment of pre-set controls using a TOOL	--	N/A
	Test pin or the test rod inserted through relevant openings with minimal force of no more than 1 N	--	N/A
	Test rod inserted in every possible position through openings provided for adjustment of pre-set controls that can be adjusted in NORMAL USE, with a force of 10 N	--	N/A
	Test repeated with a TOOL specified in instructions for use	--	N/A
	Test rod freely and vertically suspended through openings on top of ENCLOSURE	--	N/A
	e) Devices used to de-energize parts when an ACCESS COVER opened without a TOOL gives access to parts at voltages above levels permitted by this Clause comply with 8.11.1 for mains isolating switches and remain effective in SINGLE FAULT CONDITION	--	N/A
	A TOOL is required when it is possible to prevent the devices from operating	--	N/A
8.4.3	Worst case voltage between pins of plug and between either supply pin and ENCLOSURE did not exceed 60 V one s after disconnecting the plug of ME EQUIPMENT or its parts (V)	See appended Table 8.4.3	P
	A triggering circuit used to ensure disconnection occurred at peak of supply voltage waveform	--	P
	When voltage exceeded 60 V, calculated or measured stored charge didn't exceed 45 µC .. :	See appended Table 8.4.3	N/A
8.4.4	Residual voltage of conductive parts of capacitive circuits, having become accessible after ME EQUIPMENT was de-energized after removal of ACCESS COVERS, didn't exceed 60V or calculated stored charge didn't exceed 45µC... :	See appended Table 8.4.4	N/A
	A device manually discharging capacitors used when automatic discharging was not possible and ACCESS COVERS could be removed only with aid of a TOOL	--	N/A
	Capacitor(s) and connected circuitry marked with symbol 24 of Table D.1 (IEC 60417-5036, DB: 2002-10), and manual discharging device specified in technical description	--	N/A
8.5	Separation of parts		P
8.5.1	MEANS OF PROTECTION (MOP)		P

IEC 60601-1			
Clause	Requirement + Test	Result - Remark	Verdict
8.5.1.1	Two MEANS of PROTECTION provided for ME EQUIPMENT to prevent APPLIED and other ACCESSIBLE PARTS from exceeding limits in 8.4	2xMOOP provided between primary and secondary circuit within the equipment and 1xMOOP between primary circuit and protective earth.	P
	Each MEANS OF PROTECTION categorized as a MEANS OF PATIENT PROTECTION or a MEANS OF OPERATOR PROTECTION, taking into account Clause 4.6, and flow chart in Fig A.12	Protection categorized as OPERATOR protection.	P
	Varnishing, enameling, oxidation, and similar protective finishes and coatings with sealing compounds replasticizing at temperatures expected during operation and sterilization disregarded as MEANS OF PROTECTION	--	N/A
	Coatings and other insulation intended as a MEANS OF PROTECTION complying with IEC 60950-1:2001 considered acceptable as a MEANS OF OPERATOR PROTECTION but not automatically as a MEANS OF PATIENT PROTECTION	Considered.	P
	RISK MANAGEMENT PROCESS taken into consideration for MEANS OF PATIENT PROTECTION	No applied parts.	N/A
	Components and wiring forming a MEANS OF PROTECTION comply with 8.10	--	P
	Insulation, CREEPAGE, CLEARANCES, components or earth connections not complying with 8.5.1.2 and 8.5.1.3 not considered as MEANS OF PROTECTION, and failure of these parts regarded as NORMAL CONDITION	Considered. See also single fault conditions.	P
8.5.1.2	MEANS OF PATIENT PROTECTION (MOPP)	EUT not evaluated as means of patient protection (MOPP).	N/A
	Solid insulation forming a MEANS OF PATIENT PROTECTION complied with dielectric strength test of Clause 8.8 at test voltage of Table 6	--	N/A
	CREEPAGE and CLEARANCES forming a MEANS OF PATIENT PROTECTION complied with Table 12	--	N/A
	PROTECTIVE EARTH CONNECTIONS forming a MEANS OF PATIENT PROTECTION complied with Cl. 8.6	--	N/A
	A Y1 capacitor complying with IEC 60384-14 and having passed dielectric strength test for two MEANS OF PATIENT PROTECTION considered equivalent to one MEANS OF PATIENT PROTECTION	See Appended Tables 8.8.3 and 8.10	N/A
	Two capacitors used in series, each RATED for total WORKING VOLTAGE across the pair and have the same NOMINAL capacitance	--	N/A
	Voltage _{Total Working} (V) and C _{Nominal} (µF) :	--	—
8.5.1.3	MEANS OF OPERATOR PROTECTION (MOOP)	--	P

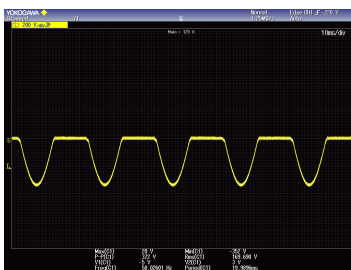
IEC 60601-1			
Clause	Requirement + Test	Result - Remark	Verdict
	Solid insulation forming a MEANS OF OPERATOR PROTECTION complied with:	--	P
	– dielectric strength test of 8.8 at test voltage of Table 6; or	--	P
	– requirements of IEC 60950-1 for INSULATION CO-ORDINATION	--	N/A
	CREEPAGE and CLEARANCES forming a MEANS OF OPERATOR PROTECTION complied with:	--	P
	– limits of Tables 13 to 16 (inclusive); or	--	P
	– requirements of IEC 60950-1 for INSULATION CO-ORDINATION	--	N/A
	PROTECTIVE EARTH CONNECTIONS forming a MEANS OF OPERATOR PROTECTION complied with Cl. 8.6, or	--	P
	– requirements and tests of IEC 60950-1 for protective earthing.....:	See Attachment #	N/A
	A Y2 capacitor complying with IEC 60384-14 and passing dielectric strength test for one MEANS OF OPERATOR PROTECTION considered equivalent to one MEANS OF OPERATOR PROTECTION :	See Appended Tables 8.8.3 and 8.10 Y2 capacitors provided between primary circuit and protective earth.	P
	A Y1 capacitor complying with IEC 60384-14 and having passed dielectric strength test for two MEANS OF OPERATOR PROTECTION considered equivalent to two MEANS OF OPERATOR PROTECTION :	See Appended Tables 8.8.3 and 8.10 Two Y2 capacitors in series connected primary to secondary.	P
	Two capacitors used in series each RATED for total WORKING VOLTAGE across the pair and have the same NOMINAL capacitance	2 x 4,7 nF Rated voltage: 250 Vac each	P
	Voltage_{Total Working} (V) and C_{Nominal} (µF)..... :	Measured voltage: 168 V _{rms} 	—
	Points at which impedances of components, CREEPAGE, CLEARANCES, PROTECTIVE EARTH CONNECTIONS or insulation, prevent ACCESSIBLE PARTS from exceeding limits in 8.4 examined whether a failure at any of these points is to be regarded as a NORMAL or SINGLE FAULT CONDITION	--	N/A

IEC 60601-1			
Clause	Requirement + Test	Result - Remark	Verdict
	A MEANS OF PROTECTION protecting APPLIED PARTS, or parts identified by 4.6 as parts subject to the same requirements, considered MEANS OF PATIENT PROTECTION..... :	--	N/A
	A MEANS OF PROTECTION protecting other parts considered MEANS OF OPERATOR PROTECTION :	--	N/A
8.5.2	Separation of PATIENT CONNECTIONS		N/A
8.5.2.1	PATIENT CONNECTIONS of F-TYPE APPLIED PART separated from all other parts by equivalent to one MEANS OF PATIENT PROTECTION for a WORKING VOLTAGE equal to maximum MAINS VOLTAGE and complied with limit for PATIENT LEAKAGE CURRENT at 110 % of max. MAINS VOLTAGE :	See appended Table 8.7. No applied parts provided. No patient connections provided.	N/A
	Separation requirement not applied between multiple functions of a single F-TYPE APPLIED PART	--	N/A
	PATIENT CONNECTIONS treated as one APPLIED PART in the absence of electrical separation between PATIENT CONNECTIONS of same or another function	--	N/A
	MANUFACTURER has defined if multiple functions are to be considered as all within one APPLIED PART or as multiple APPLIED PARTS :	--	N/A
	Classification as TYPE BF, CF, or DEFIBRILLATION-PROOF applied to one entire APPLIED PART	--	N/A
	LEAKAGE CURRENT tests conducted per 8.7.4 :	See appended Table 8.7	N/A
	Dielectric strength test conducted per 8.8.3.... :	See appended Table 8.8.3	N/A
	CREEPAGE and CLEARANCES measured per 8.9 and Tables 11 to 16 as applicable	--	N/A
	A protective device connected between PATIENT CONNECTIONS of an F-TYPE APPLIED PART and ENCLOSURE to protect against excessive voltages did not operate below 500 V r.m.s	--	N/A
8.5.2.2	PATIENT CONNECTIONS of a TYPE B APPLIED PART not PROTECTIVELY EARTHED are separated by one MEANS OF PATIENT PROTECTION from metal ACCESSIBLE PARTS not PROTECTIVELY EARTHED :	See Appended RM Results Table 8.5.2.2	N/A
	– except when metal ACCESSIBLE PART is physically close to APPLIED PART and can be regarded as a part of APPLIED PART; and	--	N/A
	– RISK that metal ACCESSIBLE PART will make contact with a source of voltage or LEAKAGE CURRENT above permitted limits is acceptably low	--	N/A
	LEAKAGE CURRENT tests conducted per 8.7.4 :	See appended Table 8.7	N/A
	Dielectric strength test conducted per 8.8.3.... :	See appended Table 8.8.3	N/A

IEC 60601-1			
Clause	Requirement + Test	Result - Remark	Verdict
	Relevant CREEPAGE and CLEARANCES measured per 8.9 and Tables 11 to 16 as applicable	--	N/A
	The RISK MANAGEMENT FILE reviewed	--	N/A
8.5.2.3	A connector on a PATIENT lead located at the end of the lead remote from PATIENT, with conductive part not separated from all PATIENT CONNECTIONS by one MEANS OF PATIENT PROTECTION for a WORKING VOLTAGE equal to MAXIMUM MAINS VOLTAGE		N/A
	- cannot be connected to earth or hazardous voltage while the PATIENT CONNECTIONS are in contact with PATIENT.....:	See Appended RM Results Table 8.5.2.3	N/A
	- conductive part of connector not separated from all PATIENT CONNECTIONS did not come into contact with a flat conductive plate of not less than 100 mm diameter	--	N/A
	- CLEARANCE between connector pins and a flat surface is at least 0.5 mm	--	N/A
	- conductive part pluggable into a mains socket protected from making contact with parts at MAINS VOLTAGE by insulation with a CREEPAGE DISTANCE of at least 1.0 mm, a 1500 V dielectric strength and complying with 8.8.4.1	--	N/A
	- required test finger did not make electrical contact with conductive part when applied against access openings with a force of 10 N, except when RISK MANAGEMENT PROCESS indicated no unacceptable RISK existed from contact with objects other than a mains socket or a flat surface	See Appended RM Results Table 8.5.2.3	N/A
8.5.3	MAXIMUM MAINS VOLTAGE		P
	- MAXIMUM MAINS VOLTAGE determined to be the highest RATED supply voltage for single-phase or d.c. SUPPLY MAINS powered ME EQUIPMENT, as well as INTERNALLY POWERED ME EQUIPMENT with a means of connection to a SUPPLY MAINS (V)	240 Vac Supply voltage: 100-240 Vac	P
	When less than 100 V, MAXIMUM MAINS VOLTAGE was 250 V	--	N/A
	- MAXIMUM MAINS VOLTAGE was the highest RATED phase to neutral supply voltage for poly-phase ME EQUIPMENT (V)	Single-phase equipment.	N/A
	- for other INTERNALLY POWERED ME EQUIPMENT, maximum mains voltage was 250 V	Not internally powered equipment.	N/A
8.5.4	WORKING VOLTAGE		P
	- Input supply voltage to ME EQUIPMENT was RATED voltage or voltage within RATED range resulting in highest measured value (V).....:	Input voltage: 240 Vac	P

IEC 60601-1			
Clause	Requirement + Test	Result - Remark	Verdict
	– WORKING VOLTAGE for d.c. voltages with superimposed ripple was average value when peak-to-peak ripple less than 10% of average value or peak voltage when peak-to-peak ripple exceeding 10% of average value (V)..... :	--	N/A
	– WORKING VOLTAGE for each MEANS OF PROTECTION forming DOUBLE INSULATION was voltage DOUBLE INSULATION, as a whole, subjected to (V)..... :	See Insulation Diagram and Insulation Table	P
	– Intentional or accidental earthing of PATIENT regarded as a NORMAL CONDITION for WORKING VOLTAGE involving a PATIENT CONNECTION not connected to earth	--	N/A
	– WORKING VOLTAGE between PATIENT CONNECTIONS of an F-TYPE APPLIED PART and ENCLOSURE was highest voltage appearing across insulation in NORMAL USE including earthing of any part of APPLIED PART (V)..... :	No applied parts provided.	N/A
	– WORKING VOLTAGE for DEFIBRILLATION-PROOF APPLIED PARTS determined disregarding possible presence of defibrillation voltages	No applied parts provided.	N/A
	– WORKING VOLTAGE was equal to resonance voltage in case of motors provided with capacitors between the point where a winding and a capacitor are connected together and a terminal for external conductors (V)..... :	No motors provided.	N/A
8.5.5	DEFIBRILLATION-PROOF APPLIED PARTS	No applied parts.	N/A
8.5.5.1	Classification “DEFIBRILLATION-PROOF APPLIED PART” applied to one APPLIED PART in its entirety, but not separate functions of same APPLIED PART	--	N/A
	Possibility of an OPERATOR receiving a shock from such parts taken into consideration in RISK MANAGEMENT PROCESS	--	N/A
	Isolation of PATIENT CONNECTIONS of a DEFIBRILLATION-PROOF APPLIED PART from other parts of ME EQUIPMENT accomplished as follows:	--	N/A
	a) No hazardous electrical energies appear during a discharge of cardiac defibrillator	See Appended Table 8.5.5.1a	N/A
	b) ME EQUIPMENT complied with relevant requirements of this standard, providing BASIC SAFETY and ESSENTIAL PERFORMANCE following exposure to defibrillation voltage, and recovery time stated in ACCOMPANYING DOCUMENTS	See Appended Table 8.5.5.1b	N/A
8.5.5.2	Means provided to limit energy delivered to a 100 Ω load to at least 90% of energy delivered to this load with ME EQUIPMENT disconnected .. :	See Appended Table 8.5.5.2	N/A
8.6	Protective and functional earthing and potential equalization of ME EQUIPMENT		P

IEC 60601-1			
Clause	Requirement + Test	Result - Remark	Verdict
8.6.1	Requirements of 8.6.2 to 8.6.8 applied	EUT is class I equipment.	P
	Parts complying with IEC 60950-1 for protective earthing and serving as MEANS OF OPERATOR PROTECTION but not PATIENT PROTECTION exempted from requirements of 8.6.2 to 8.6.8	--	N/A
8.6.2	PROTECTIVE EARTH TERMINAL is suitable for connection to an external protective earthing system by a PROTECTIVE EARTH CONDUCTOR in a POWER SUPPLY CORD and a suitable plug or by a FIXED PROTECTIVE EARTH CONDUCTOR	Part of approved appliance inlet.	P
	Clamping means of PROTECTIVE EARTH TERMINAL of ME EQUIPMENT for FIXED supply conductors or POWER SUPPLY CORDS comply with 8.11.4.3, and cannot be loosened without TOOL	Internal protective earth conductor fixed to enclosure by screw. See enclosed pictures of the unit for details.	P
	Screws for internal PROTECTIVE EARTH CONNECTIONS completely covered or protected against accidental loosening from outside.....	Internal earth connections.	P
	Earth pin of APPLIANCE INLET forming supply connection to ME EQUIPMENT regarded as PROTECTIVE EARTH TERMINAL	--	P
	PROTECTIVE EARTH TERMINAL not used for mechanical connection between different parts of ME EQUIPMENT or securing components not related to protective or functional earthing	Not used for other purposes.	N/A
8.6.3	PROTECTIVE EARTH CONNECTION not used for a moving part, except when MANUFACTURER demonstrated in RISK MANAGEMENT FILE connection will remain reliable during EXPECTED SERVICE LIFE	See Appended RM Results Table 8.6.3 No such moving parts.	N/A
8.6.4	a) PROTECTIVE EARTH CONNECTIONS carried fault currents reliably and without excessive voltage drop	See appended Table 8.6.4	P
	b) Allowable TOUCH CURRENT and PATIENT LEAKAGE CURRENT in SINGLE FAULT CONDITION were not exceeded, when impedance of PROTECTIVE EARTH CONNECTIONS exceeded values in 8.6.4 a) and Table 8.6.4, due to limited current capability of relevant circuits	See appended Table 8.6.4 & Clause 8.7	N/A
8.6.5	Surface coatings		N/A
	Poorly conducting surface coatings on conductive elements removed at the point of contact	--	N/A
	Coating not removed when requirements for impedance and current-carrying capacity met	--	N/A
8.6.6	Plugs and sockets		P

IEC 60601-1			
Clause	Requirement + Test	Result - Remark	Verdict
	PROTECTIVE EARTH CONNECTION where connection between SUPPLY MAINS and ME EQUIPMENT or between separate parts of ME EQUIPMENT made via a plug and socket was made before and interrupted after supply connections	Approved appliance inlet used. PE pin on socket longer than line and neutral.	P
	- applied also where interchangeable parts are PROTECTIVELY EARTHED	No such parts.	N/A
8.6.7	Terminal for connection of a POTENTIAL EQUALIZATION CONDUCTOR		P
	- Terminal is accessible to OPERATOR with ME EQUIPMENT in any position of NORMAL USE	Terminal provided near appliance inlet. See enclosed pictures of the unit for details.	P
	- RISK of accidental disconnection minimized in NORMAL USE	Standard connector used.	P
	- Terminal allows conductor to be detached without a TOOL	Standard connector used.	P
	- Terminal not used for a PROTECTIVE EARTH CONNECTION	Not used.	P
	- Terminal marked with symbol 8 of Table D.1 (i.e., symbol IEC 60417-5021)	Correct symbol used.	P
	- Instructions for use contain information on function and use of POTENTIAL EQUALIZATION CONDUCTOR together with a reference to requirements of this standard	Power supply unit is intended for building-in. Shall be provided within user manual of the end medical product.	N/A
	POWER SUPPLY CORD does not incorporate a POTENTIAL EQUALIZATION CONDUCTOR	--	N/A
8.6.8	FUNCTIONAL EARTH TERMINAL not used to provide a PROTECTIVE EARTH CONNECTION		N/A
8.6.9	Class II ME EQUIPMENT		N/A
	Third conductor of POWER SUPPLY CORD connected to protective earth contact of MAINS PLUG provided with CLASS II ME EQUIPMENT with isolated internal screens used as functional earth connection to the screen's FUNCTIONAL EARTH TERMINAL, coloured green and yellow	EUT Class I equipment.	N/A
	Two MEANS OF PROTECTION provided by insulation of internal screens and all internal wiring connected to them with a related explanation in technical description	--	N/A
8.7	LEAKAGE CURRENTS and PATIENT AUXILIARY CURRENTS		P
8.7.1	a) Electrical isolation providing protection against electric shock limits currents to values in 8.7.3..... :	See appended Tables 8.7	P

IEC 60601-1			
Clause	Requirement + Test	Result - Remark	Verdict
	b) Specified values of EARTH LEAKAGE, TOUCH, PATIENT LEAKAGE, and PATIENT AUXILIARY CURRENTS applied in combination of conditions in appended Table 8.7	See appended Tables 8.7	P
8.7.2	Allowable values specified in 8.7.3 applied under SINGLE FAULT CONDITIONS of 8.1 b), except	--	P
	– where insulation used in conjunction with a PROTECTIVE EARTH CONNECTION, insulation short circuited only under conditions in 8.6.4 b)	--	N/A
	– the only SINGLE FAULT CONDITION for EARTH LEAKAGE CURRENT was interruption of one supply conductor at a time	--	P
	– LEAKAGE CURRENTS and PATIENT AUXILIARY CURRENT not measured in SINGLE FAULT CONDITION of short circuiting of one constituent part of DOUBLE INSULATION	--	N/A
	SINGLE FAULT CONDITIONS not applied at same time as special test conditions of MAXIMUM MAINS VOLTAGE on APPLIED PARTS and non-PROTECTIVELY EARTHED parts of ENCLOSURE	No applied parts provided.	N/A
8.7.3	Allowable Values		P
	a) Allowable values in 8.7.3 b), c), and d) measured based on, and are relative to currents in Fig 12 a), or by a device measuring frequency contents of currents as in Fig 12 b.:	See appended Table 8.7	P
	b) Allowable values of PATIENT LEAKAGE and AUXILIARY CURRENTS are according to Tables 3 & 4, and values of a.c. are relative to currents having a frequency not less than 0.1Hz	See appended Table 8.7	N/A
	c) TOUCH CURRENT did not exceed 100 μA in NORMAL CONDITION and 500 μA in SINGLE FAULT CONDITION (I_{TNC}, I_{TSFC})	See appended Table 8.7 Equipment provides five outputs. Those outputs shall not be accessible by the user and are only used for supplying end medical product by its output voltages. Metal enclosure of the equipment protectively earthed .	N/A
	d) EARTH LEAKAGE CURRENT did not exceed 5 mA in NORMAL CONDITION and 10 mA in SINGLE FAULT CONDITION (I_{ENC}, I_{ESFC})	See appended Table 8.7	P
	Higher values of EARTH LEAKAGE CURRENT permitted for PERMANENTLY INSTALLED ME EQUIPMENT connected to a supply circuit supplying only this ME EQUIPMENT according to local regulations or IEC 60364-7-710	See appended Table 8.7	N/A

IEC 60601-1			
Clause	Requirement + Test	Result - Remark	Verdict
	e) LEAKAGE CURRENTS, regardless of waveform and frequency, did not exceed 10 mA r.m.s. in NORMAL or in SINGLE FAULT CONDITION (measured with a non-frequency-weighted device :	See appended Table 8.7	N/A
8.7.4	LEAKAGE and PATIENT AUXILIARY CURRENTS measurements :	See appended Table 8.7	P
8.8	Insulation		P
8.8.1	Insulation relied on as MEANS OF PROTECTION, including REINFORCED INSULATION and insulation between parts of opposite polarity of MAINS PART on SUPPLY MAINS side of mains fuse or OVER-CURRENT RELEASE	--	P
	Insulation exempted from test (complies with clause 4.8)	IEC approved optocouplers U300, U6, U7 provided between primary and secondary circuit.	P
	Insulation forming MEANS OF OPERATOR PROTECTION and complying with IEC 60950-1 for INSULATION CO-ORDINATION not tested as in 8.8	--	P
8.8.2	Distance through solid insulation or use of thin sheet material		P
	Solid insulation forming SUPPLEMENTARY or REINFORCED INSULATION for a PEAK WORKING VOLTAGE greater than 71 V provided with:	--	P
	a) 0.4 mm, min, distance through insulation, or	IEC approved optocouplers U300, U6, U7 provided between primary and secondary circuit. See list of critical components for details.	P
	b) does not form part of an ENCLOSURE and not subject to handling or abrasion during NORMAL USE, and comprised of:	--	N/A
	– at least two layers of material, each passed the appropriate dielectric strength test, or	See appended Table 8.8.3	N/A
	– three layers of material, for which all combinations of two layers together passed the appropriate dielectric strength test	See appended Table 8.8.3 Approved triple insulated wire used for secondary windings of transformer T2. See list of critical components.	N/A
	Dielectric strength test for one or two layers was same as for one MEANS OF PROTECTION for SUPPLEMENTARY INSULATION	--	N/A
	Dielectric strength test for one or two layers was same as for two MEANS OF PROTECTION for REINFORCED INSULATION	--	N/A

IEC 60601-1			
Clause	Requirement + Test	Result - Remark	Verdict
	BASIC, SUPPLEMENTARY, and REINFORCED INSULATION required between windings of wound components separated by interleaved insulation complying with a) or b), or both, except when	--	P
	c) Wire with solid insulation, other than solvent based enamel, complying with a)	--	P
	d) Wire with multi-layer extruded or spirally wrapped insulation complying with b) and complying with Annex L	Approved triple insulated wire used for secondary windings on transformer T2. See list of critical components.	P
	e) Finished wire with spirally wrapped or multi-layer extruded insulation, complying with Annex L	--	N/A
	– BASIC INSULATION: minimum two wrapped layers or one extruded layer	--	N/A
	– SUPPLEMENTARY INSULATION: minimum two layers, wrapped or extruded	--	N/A
	– REINFORCED INSULATION: minimum three layers, wrapped or extruded	--	N/A
	In d) and e), for spirally wrapped insulation with CREEPAGE DISTANCES between layers less than in Table 12 or 16 (Pollution Degree 1) depending on type of insulation, path between layers sealed as a cemented joint in 8.9.3.3 and test voltages of TYPE TESTS in L.3 equal 1.6 times of normal values	--	N/A
	Protection against mechanical stress provided where two insulated wires or one bare and one insulated wire are in contact inside wound component, crossing at an angle between 45° and 90° and subject to winding tension	--	N/A
	Finished component complied with routine dielectric strength tests of 8.8.3	See appended Table 8.8.3	N/A
	Tests of Annex L not repeated since material data sheets confirm compliance	See Table 8.10 and Material Information Attachment	N/A
8.8.3	Dielectric Strength		P
	Solid insulating materials with a safety function withstood dielectric strength test voltages	See appended Table 8.8.3	P
8.8.4	Insulation other than wire insulation		P
8.8.4.1	Resistance to heat retained by all insulation and insulating partition walls during EXPECTED SERVICE LIFE OF ME EQUIPMENT	--	P

IEC 60601-1			
Clause	Requirement + Test	Result - Remark	Verdict
	ME EQUIPMENT and RISK MANAGEMENT FILE examined in conjunction with resistance to moisture, dielectric strength, and mechanical strength tests	See Appended RM Results Table 8.8.4.1	N/A
	Satisfactory evidence of compliance provided by manufacturer for resistance to heat	Manufacturer is using approved materials with adequate temperature characteristics. See Table 8.10. No additional test was considered required.	P
	Tests conducted in absence of satisfactory evidence for resistance to heat	--	N/A
	a) ENCLOSURE and other external parts of insulating material, except insulation of flexible cords and parts of ceramic material, subjected to ball-pressure test using apparatus of Fig 21	See Table 8.8.4.1	N/A
	b) Parts of insulating material supporting uninsulated parts of MAINS PART subjected to ball-pressure test in a), except at 125 °C ± 2 ° C or ambient indicated in technical description ±2°C plus temperature rise determined during test of 11.1 of relevant part, if higher (°C)	See Table 8.8.4.1	N/A
	Test not performed on parts of ceramic material, insulating parts of commutators, brush-caps, and similar, and on coil formers not used as REINFORCED INSULATION	--	N/A
8.8.4.2	Resistance to environmental stress		N/A
	Insulating characteristics and mechanical strength of all MEANS OF PROTECTION not likely to be impaired by environmental stresses including deposition of dirt resulting from wear of parts within EQUIPMENT, potentially reducing CREEPAGE and CLEARANCES below 8.9	--	N/A
	Ceramic and similar materials not tightly sintered, and beads alone not used as SUPPLEMENTARY OF REINFORCED INSULATION	--	N/A
	Insulating material with embedded heating conductors considered as one MEANS OF PROTECTION but not two MEANS OF PROTECTION	--	N/A
	Parts of natural latex rubber aged by suspending samples freely in an oxygen cylinder containing commercial oxygen to a pressure of 2.1 MPa ± 70 kPa, with an effective capacity of at least 10 times volume of samples	--	N/A

IEC 60601-1			
Clause	Requirement + Test	Result - Remark	Verdict
	There were no cracks visible to naked eyes after samples kept in cylinder at 70 °C ± 2 °C for 96h, and afterwards, left at room temperature for at least 16h	--	N/A
8.9	CREEPAGE DISTANCES and AIR CLEARANCES		P
8.9.1.1	CREEPAGE DISTANCES and AIR CLEARANCES are ≥ to values in Tables 11 to 16 (inclusive), except as specified in Clauses 8.9.1.2 to 8.9.1.15	--	P
8.9.1.2	Tables 11 to 16 (inclusive) not applied to CREEPAGE and CLEARANCES forming MEANS OF OPERATOR PROTECTION per IEC 60950-1 for INSULATION CO-ORDINATION and used under conditions compliance was tested	Creepage and clearance distances in accordance with table 11 to 16 apply.	N/A
8.9.1.3	Specified min CLEARANCE applied as min CREEPAGE for CREEPAGE DISTANCES across glass, mica, ceramic and other inorganic insulating materials with similar tracking characteristics	No such insulation material provided.	N/A
8.9.1.4	When min CREEPAGE derived from Tables 11 to 16 (inclusive) was less than min applicable CLEARANCE, value of min CLEARANCE applied as min CREEPAGE DISTANCE	Considered.	P
8.9.1.5	ME EQUIPMENT RATED to operate at an altitude of 2000 m	EUT was evaluated for use up to 2.000 meters.	P
	ME EQUIPMENT RATED to operate at an altitude specified by MANUFACTURER (m)	--	N/A
	Operating altitude corresponding to actual air pressure for ME EQUIPMENT intended for pressurized environments (e.g., aircraft) used to determine multiplication factor from Table 8, and AIR CLEARANCE was multiplied by this factor	--	N/A
	CREEPAGE DISTANCES not subjected to multiplication factors, but were at least as large as the resulting value for AIR CLEARANCE	--	N/A
8.9.1.6	When WORKING VOLTAGE was between those in Tables 11 to 16 (inclusive), CREEPAGE and CLEARANCES calculated as follows:	--	P
	– CREEPAGE DISTANCES determined by linear interpolation between the nearest two values, and the calculated spacing rounded off to the next higher 0.1 mm increment (mm)	See Insulation Diagram/Table. Considered.	P
	– CLEARANCES for PEAK WORKING VOLTAGES above 2800 V peak or d.c. determined by linear interpolation between the nearest two values, and the calculated spacing rounded off to the next higher 0.1 mm increment (mm)	See Insulation Diagram/Table. No such voltages obtained during normal use of the equipment.	N/A
	– for AIR CLEARANCES corresponding to PEAK WORKING VOLTAGE up to 2800 V peak or d.c., the higher of the two values applied	See above.	N/A

IEC 60601-1			
Clause	Requirement + Test	Result - Remark	Verdict
8.9.1.7	Material groups classified in accordance with Table 9 (Material Group)..... :	See Insulation Diagram/Table.	P
	Material group evaluated using 50 drops of solution A based on test data for material according to IEC 60112 :	See attached test data	N/A
	Material of unknown group considered IIIb	Considered.	P
8.9.1.8	– Pollution degree 1: Micro-environment sealed to exclude dust and moisture	--	N/A
	– Pollution degree 2: Micro-environment with non-conductive pollution, except occasional conductivity caused by condensation	EUT was evaluated for use within pollution degree 2 environmental.	P
	– Pollution degree 3: Micro-environment subject to conductive pollution, or dry non-conductive pollution that could become conductive due to expected condensation	--	N/A
	– Pollution degree 4: Micro-environment where continuous conductivity occurs due to conductive dust, rain, or other wet conditions	--	N/A
	Pollution degree 4 not used for insulation providing a MEANS OF PROTECTION	--	N/A
	Where insulation between MAINS PART and earth might be compromised, measures such as maintenance ensure that micro-environment is mitigated to a lower pollution degree	--	N/A
8.9.1.9	Overvoltage category classification; value of MAINS TRANSIENT VOLTAGE determined from overvoltage category per IEC60664-1 and NOMINAL a.c. MAINS VOLTAGE using Table 10	--	P
	V_{MT} Peak (V)	2500	—
	V_{MN} r.m.s (V)	300	—
8.9.1.10	AIR CLEARANCE for MAINS PARTS (operating on RATED MAINS VOLTAGES up to 300 V) were values for r.m.s. or d.c. RATED MAINS VOLTAGE in Table 13 plus additional CLEARANCE in Table 14 for PEAK WORKING VOLTAGE	Considered.	P
8.9.1.11	SUPPLY MAINS overvoltage category II applied according to IEC 60664-1	--	P
	For ME EQUIPMENT intended for overvoltage category III, Tables 13 to 15 (inclusive) not used for clearance, instead values in the next MAINS TRANSIENT VOLTAGE column upwards used	--	N/A
	When PATIENT protection (Table 12) is required for use of ME EQUIPMENT on overvoltage category III SUPPLY MAINS, guidance provided on values required in the rationale for Cl. 8.9 used	No applied parts provided.	N/A

IEC 60601-1			
Clause	Requirement + Test	Result - Remark	Verdict
8.9.1.12	A SECONDARY CIRCUIT derived from a SUPPLY MAINS, normally, considered to be overvoltage category I according to IEC 60664-1 when the MAINS PART is overvoltage category II (Table 15)	--	N/A
	Table 15 applied to earthed SECONDARY CIRCUIT OR INTERNALLY POWERED ME EQUIPMENT	--	N/A
	Requirements for primary circuits in Tables 13 and 14 used for an unearthed SECONDARY CIRCUIT derived from a SUPPLY MAINS	--	N/A
	Table 15 applied when SECONDARY CIRCUIT was separated from MAINS PART by a functionally earthed or PROTECTIVELY EARTHED metal screen or transients in SECONDARY CIRCUIT were below the levels expected for overvoltage category I	--	N/A
	Table 15 column for circuits not subject to transient overvoltages applied to:	--	N/A
	– d.c. SECONDARY CIRCUITS reliably connected to earth and have capacitive filtering limiting peak-to-peak ripple to 10 % of d.c. voltage, and	--	N/A
	– circuits in INTERNALLY POWERED ME EQUIPMENT	EUT is not internally powered equipment.	N/A
8.9.1.13	For PEAK WORKING VOLTAGES above 1400 V peak or d.c. Table 15 not applied since all the following conditions were met:	No such voltages under normal use of the equipment.	N/A
	– CLEARANCE was at least 5 mm	--	N/A
	– insulation complied with dielectric strength test of 8.8.3 using an a.c. test voltage with an r.m.s. value equal to 1.06 times PEAK WORKING VOLTAGE, or	--	N/A
	– a d.c. test voltage equal to peak value of a.c. test voltage with an r.m.s. value equal to 1.06 times PEAK WORKING VOLTAGE, and	--	N/A
	– CLEARANCE path was partly or entirely through air or along the surface of an insulating material of material group I	--	N/A
	Dielectric strength test conducted only across part(s) of the path that are through air when CLEARANCE path was also partly along surface of a non- group I material	--	N/A
8.9.1.14	Minimum CREEPAGE DISTANCES for two MEANS OF OPERATOR PROTECTION obtained by doubling values in Table 16 for one MEANS OF OPERATOR PROTECTION	Considered.	P
8.9.1.15	CREEPAGE DISTANCES and AIR CLEARANCES for DEFIBRILLATION-PROOF APPLIED PARTS are 4 mm or more to meet 8.5.5.1	No applied parts provided.	N/A

IEC 60601-1			
Clause	Requirement + Test	Result - Remark	Verdict
8.9.2	a) Short circuiting of each single one of CREEPAGE DISTANCES and CLEARANCES in turn did not result in a HAZARDOUS SITUATION for insulation in MAINS PART between parts of opposite polarity, therefore, min CREEPAGE and CLEARANCES not applied..... :	See appended Table 8.9.2 Sufficient creepage and clearance distances provided between parts of opposite polarity before mains fuses. Short circuit performed after primary fuses. No hazardous situation.	N/A
	b) Contribution to CREEPAGE DISTANCES of grooves or air gaps less than 1 mm wide limited to widths	Considered.	P
	c) Relative positioning of CLEARANCE providing a MEANS OF PROTECTION is such that the relevant parts are rigid and located by molding, or there is no reduction of a distance below specified value by deformation or movement of parts	--	P
	Normal or likely limited movements of relevant parts taken into consideration when calculating minimum AIR CLEARANCE	--	N/A
8.9.3	Spaces filled by insulating compound		N/A
8.9.3.1	Only solid insulation requirements applied where distances between conductive parts filled with insulating compound were such that CLEARANCES and CREEPAGE DISTANCES don't exist	No parts filled with insulation compounds. Approved optocouplers connected between primary and secondary circuit. See list of critical components.	N/A
	Thermal cycling, humidity preconditioning, and dielectric strength tests in 8.9.3.2 and 8.9.3.4 or 8.9.3.3 and 8.9.3.4 conducted	--	N/A
8.9.3.2	For insulating compound forming solid insulation between conductive parts, a single sample subjected to thermal cycling PROCEDURE of 8.9.3.4 followed by humidity preconditioning per 5.7 (for 48 hours), followed by dielectric strength test (clause 8.8.3), test voltage multiplied by 1.6..... :	See appended Table 8.9.3.2	N/A
	Cracks or voids in insulating compound affecting homogeneity of material didn't occur	--	N/A
8.9.3.3	Where insulating compound forms a cemented joint with other insulating parts, three samples tested for reliability of joint	--	N/A
	A winding of solvent-based enameled wire replaced for the test by a metal foil or by a few turns of bare wire placed close to cemented joint, and three samples tested as follows:	--	N/A

IEC 60601-1			
Clause	Requirement + Test	Result - Remark	Verdict
	– One sample subjected to thermal cycling PROCEDURE of 8.9.3.4, and immediately after the last period at highest temperature during thermal cycling, it was subjected to dielectric strength test of 8.8.3 except at 1.6 times the test voltage	See appended Table 8.9.3.4	N/A
	– The other two samples subjected to humidity preconditioning of 5.7, except for 48 hours only followed by a dielectric strength test of 8.8.3 at 1.6 times the test voltage	--	N/A
8.9.3.4	One sample containing the cemented joint subjected to a sequence of temperature cycling tests for 10 times	See appended Table 8.9.3.4	N/A
8.10	Components and wiring		P
8.10.1	Components of ME EQUIPMENT likely to result in an unacceptable RISK by their movements mounted securely as indicated in RISK MANAGEMENT FILE	See Appended RM Results Table 8.10.1 All components mounted securely. Glue used for fixing of some components. Unwanted movement of single component not result unacceptable risk. See enclosed pictures of the unit for details.	P
8.10.2	Conductors and connectors of ME EQUIPMENT adequately secured or insulated to prevent accidental detachment in a HAZARDOUS SITUATION	See Appended RM Results Table 8.10.2 Internal conductors adequate secured.	P
	Conductors and connectors of ME EQUIPMENT when breaking free at their joint are not capable of touching circuit points resulting in a HAZARDOUS SITUATION as indicated in RISK MANAGEMENT FILE	--	N/A
	Breaking free of one means of mechanical restraint considered a SINGLE FAULT CONDITION	--	N/A
	Stranded conductors are not solder-coated when secured by clamping means to prevent HAZARDOUS SITUATIONS due to poor contact	--	N/A
8.10.3	Flexible cords detachable without a TOOL used to interconnect different parts of ME EQUIPMENT provided with means for connection to comply with requirements for metal ACCESSIBLE PARTS of 8.4 when a connection is loosened or broken as shown by measurement or using test finger	See Appended Table 5.9.2 No such cord provided.	N/A
8.10.4	Cord-connected HAND-HELD parts and cord-connected foot-operated control devices		N/A

IEC 60601-1			
Clause	Requirement + Test	Result - Remark	Verdict
8.10.4.1	Control devices of ME EQUIPMENT and their connection cords contain only conductors and components operating at 42.4 V peak a.c., max, or 60 V d.c. in circuits isolated from MAINS PART by two MEANS OF PROTECTION	EUT for building-in.	N/A
	d.c. limit of 60 V applied to d.c. with no more than 10 % peak-to-peak ripple	--	N/A
	42.4 V peak limit applied when ripple exceeded 10 % peak-to-peak limit	--	N/A
8.10.4.2	Connection and anchorage of a flexible cord to a HAND-HELD or foot-operated control device of ME EQUIPMENT at both ends of cable to control device complied with 8.11.3 when breaking free or shorting between conductors could result in a HAZARDOUS SITUATION	--	N/A
	This requirement applied to other HAND-HELD parts when disturbance or breaking of one or more of connections could result in a HAZARDOUS SITUATION	--	N/A
8.10.5	Mechanical protection of wiring		P
	a) Internal cables and wiring adequately protected against contact with a moving part or from friction at sharp corners and edges where damage to insulation could result in a HAZARDOUS SITUATION	See Appended RM Results Table 8.10.5 There are only two ventilation fans. Internal cables protected against contact with ventilation blades. No other moving parts.	P
	b) Wiring, cord forms, or components are not likely to be damaged during assembly or during opening or closing of ACCESS COVERS where such damage could result in a HAZARDOUS SITUATION as shown by manual tests and RISK MANAGEMENT FILE	--	N/A
8.10.6	Guiding rollers of insulated conductors prevent bending of movable insulated conductors around a radius of less than five times the outer diameter of the lead concerned in NORMAL USE	--	N/A
8.10.7	a) Insulating sleeve that can only be removed by breaking or cutting, or secured at both ends, is used on internal wiring of when needed	See appended Table 8.10 No insulation sleeve used on internal wiring.	N/A
	b) Sheath of a flexible cord not used as a MEANS OF PROTECTION inside ME EQUIPMENT when it is subject to mechanical or thermal stresses beyond its RATED characteristics	--	N/A

IEC 60601-1			
Clause	Requirement + Test	Result - Remark	Verdict
	c) Insulated conductors subject to temperatures > 70 °C in NORMAL USE provided with insulation of heat-resistant material when compliance is likely to be impaired due to deterioration of insulation.....:	See appended Table 8.10	N/A
8.11	MAINS PARTS, components and layout		P
8.11.1	a) ME EQUIPMENT provided with means of electrically isolating its circuits from SUPPLY MAINS simultaneously on all poles.....:	See appended Table 8.10 Power supply is intended for building in. Means of disconnection from the mains shall be provided within the end product.	N/A
	PERMANENTLY INSTALLED ME EQUIPMENT connected to a poly-phase SUPPLY MAINS equipped with a device not interrupting neutral conductor, provided local installation conditions prevent voltage on neutral conductor from exceeding limits in 8.4.2 c)	EUT not permanently installed equipment.	N/A
	b) Means of isolation incorporated in ME EQUIPMENT, and external means described in technical description	See appended Table 8.10	N/A
	c) A SUPPLY MAINS switch used to comply with 8.11.1 a) complies with CREEPAGE and CLEARANCES in IEC 61058-1 for a MAINS TRANSIENT VOLTAGE of 4 kV	See appended Table 8.10	N/A
	d) A SUPPLY MAINS switch not incorporated in a POWER SUPPLY CORD or external flexible lead	--	N/A
	e) Direction of movement of actuator of a SUPPLY MAINS switch used to comply with 8.11.1 a) complies with IEC 60447	--	N/A
	f) A suitable plug device such as an APPLIANCE COUPLER or a flexible cord with a MAINS PLUG used in non-PERMANENTLY INSTALLED ME EQUIPMENT to isolate it from SUPPLY MAINS considered to comply with 8.11.1 a)	See appended Table 8.10	N/A
	g) A fuse or a semiconductor device not used as an isolating means	--	N/A
	h) ME EQUIPMENT not provided with a device causing disconnection of ME EQUIPMENT from SUPPLY MAINS by producing a short circuit resulting in operation of an overcurrent protection device	--	N/A

IEC 60601-1			
Clause	Requirement + Test	Result - Remark	Verdict
	i) Parts within ENCLOSURE of ME EQUIPMENT with a circuit > 42.4 V peak a.c. or 60 V d.c. that cannot be disconnected from its supply by an external switch or a plug device accessible at all times is protected against touch even after opening ENCLOSURE by an additional covering	--	N/A
	A clear warning notice is marked on outside of ME EQUIPMENT to indicate it exceeds allowable touch voltage (symbol 10 of Table D.1 is insufficient)	--	N/A
	For a part that could not be disconnected from supply by an external switch or a plug device accessible at all times, the required cover or warning notice complied with this clause	--	N/A
	Standard test finger of Fig 6 applied	--	N/A
8.11.2	MULTIPLE SOCKET-OUTLETS integral with ME EQUIPMENT complied with 16.2 d), second dash; and 16.9.2	No multiple socket outlet provided.	N/A
8.11.3	POWER SUPPLY CORDS		N/A
8.11.3.1	MAINS PLUG not fitted with more than one POWER SUPPLY CORD	Power supply cord not part of the investigation.	N/A
8.11.3.2	POWER SUPPLY CORDS are no less robust than ordinary tough rubber sheathed flexible cord (IEC 60245-1:2003, Annex A, designation 53) or ordinary polyvinyl chloride sheathed flexible cord (IEC 60227-1:1993, Annex A, design. 53).. :	See appended Table 8.10	N/A
	Only polyvinyl chloride insulated POWER SUPPLY CORD with appropriate temperature rating used for ME EQUIPMENT having external metal parts with a temperature > 75 °C touchable by the cord in NORMAL USE	See appended Table 8.10	N/A
8.11.3.3	NOMINAL cross-sectional area of conductors of POWER SUPPLY CORDS of ME EQUIPMENT is not less than in Table 17 (mm ² Cu)..... :	--	N/A
8.11.3.4	APPLIANCE COUPLERS complying with IEC 60320-1 are considered to comply with 8.11.3.5 and 8.11.3.6	See appended Table 8.10	N/A
8.11.3.5	Cord anchorage (for APPLIANCE COUPLERS not complying with IEC 60320-1)		N/A
	a) Conductors of POWER SUPPLY CORD provided with strain relieve and insulation protected from abrasion at point of entry to ME EQUIPMENT or a MAINS CONNECTOR by a cord anchorage	Power supply cord not part of the investigation.	N/A
	b) Cord anchorage of POWER SUPPLY CORD is made of and arranged as follows when a total insulation failure of POWER SUPPLY CORD caused conductive NON-PROTECTIVELY EARTHED ACCESSIBLE PARTS to exceed limits of 8.4:	--	N/A
	– insulating material, or	--	N/A

IEC 60601-1			
Clause	Requirement + Test	Result - Remark	Verdict
	– metal, insulated from conductive ACCESSIBLE PARTS non-PROTECTIVELY EARTHED by a MEANS OF PROTECTION, or	--	N/A
	– metal provided with an insulating lining affixed to cord anchorage, except when it is a flexible bushing forming part of the cord guard in 8.11.3.6, and complying with the requirements for one MEANS OF PROTECTION	--	N/A
	c) Cord anchorage prevents cord from being clamped by a screw bearing directly on cord insulation	--	N/A
	d) Screws to be operated when replacing POWER SUPPLY CORD do not serve to secure any components other than parts of cord anchorage	--	N/A
	e) Conductors of POWER SUPPLY CORD arranged to prevent PROTECTIVE EARTH CONDUCTOR against strain as long as phase conductors are in contact with their terminals when cord anchorage fails	--	N/A
	f) Cord anchorage prevents POWER SUPPLY CORD from being pushed into ME EQUIPMENT or MAINS CONNECTOR	--	N/A
	Conductors of POWER SUPPLY CORD supplied by MANUFACTURER disconnected from terminals or from MAINS CONNECTOR and cord subjected 25 times to a pull applied with no jerks, each time for 1 s, on sheath of the value in Table 18	See appended Table 8.11.3.5	N/A
	Cord subjected to a torque in Table 18 for 1 min immediately after pull tests	--	N/A
	Cord anchorage did not allow cord sheath to be longitudinally displaced by more than 2 mm or conductor ends to move over a distance of more than 1 mm from their connected position	--	N/A
	CREEPAGE and CLEARANCES not reduced below limits in 8.9	--	N/A
	It was not possible to push the cord into ME EQUIPMENT or MAINS CONNECTOR to an extent the cord or internal parts would be damaged	--	N/A
8.11.3.6	POWER SUPPLY CORDS other than for STATIONARY ME EQUIPMENT protected against excessive bending at inlet opening of equipment or of MAINS CONNECTOR by means of an insulating cord guard or by means of an appropriately shaped opening	Power supply cord not part of the investigation.	N/A
	Cord guard complied with test of IEC 60335-1:2001, Clause 25.14, or	--	N/A

IEC 60601-1			
Clause	Requirement + Test	Result - Remark	Verdict
	ME EQUIPMENT placed such that axis of cord guard projected at an angle of 45° with cord free from stress, and a mass equal 10 x D ² gram attached to the free end of cord (g) :	See appended Table 8.11.3.6	N/A
	Cord guard of temperature-sensitive material tested at 23 °C ± 2 °C, and flat cords bent in the plane of least resistance	--	N/A
	Curvature of the cord radius, immediately after mass attached, was not less than 1.5 x D :	See appended Table 8.11.3.6	N/A
8.11.4	MAINS TERMINAL DEVICES		N/A
8.11.4.1	PERMANENTLY INSTALLED and ME EQUIPMENT with non-DETACHABLE POWER SUPPLY CORD replaceable by SERVICE PERSONNEL provided with MAINS TERMINAL DEVICES ensuring reliable connection	Not permanently installed equipment. EUT for building. Mains connected via approved appliance inlet.	N/A
	Terminals alone are not used to keep conductors in position, except when barriers are provided such that CREEPAGE and CLEARANCES cannot be reduced below 8.9 if any conductor breaks away	--	N/A
	Terminals of components other than terminal blocks complying with requirements of this Clause and marked according to 7.3.7 used as terminals intended for external conductors	--	N/A
	Screws and nuts clamping external conductors do not serve to secure any other component, except they also clamp internal conductors when unlikely to be displaced when fitting the supply conductors	--	N/A
8.11.4.2	Arrangement of MAINS TERMINAL DEVICES		N/A
	a) Terminals provided for connection of external cords or POWER SUPPLY CORDS together with PROTECTIVE EARTH TERMINAL grouped to provide convenient means of connection	--	N/A
	b) PROTECTIVE EARTH CONDUCTOR connections complied with 8.6	--	N/A
	c) Marking of MAINS TERMINAL DEVICES complied with 7.3	--	N/A
	d) MAINS TERMINAL DEVICES not accessible without use of a TOOL	--	N/A
	e) A MEANS OF PROTECTION are not short circuited when one end of a flexible conductor with NOMINAL cross-sectional area is stripped 8 mm and a single free wire is bent in each possible direction	--	N/A

IEC 60601-1			
Clause	Requirement + Test	Result - Remark	Verdict
8.11.4.3	Internal wiring not subjected to stress and CREEPAGE and CLEARANCES not reduced below 8.9 after fastening and loosening a conductor of largest cross-sectional area 10 times	--	N/A
8.11.4.4	Terminals with clamping means for a rewirable flexible cord did not require special preparation of conductors and conductors were not damaged and did not slip out when clamping means tightened as verified by test of 8.11.3.4	--	N/A
8.11.4.5	Adequate space provided inside ME EQUIPMENT designed for FIXED wiring or a re-wirable POWER SUPPLY CORD to allow for connection of conductors, and covers fitted without damage to conductors or their insulation	--	N/A
	Correct connection and positioning of conductors before ACCESS COVER was fitted verified by an installation test	--	N/A
8.11.5	Mains fuses and OVER-CURRENT RELEASES		P
	A fuse or OVER-CURRENT RELEASE provided in each supply lead for CLASS I and CLASS II ME EQUIPMENT with a functional earth connection per clause 8.6.9, and in at least one supply lead for other single-phase CLASS II ME EQUIPMENT.....:	See appended Table 8.10 and Appended RM Results Table 8.11.5 Two primary fuses used (in line and neutral) EUT is Class I equipment.	P
	– neutral conductor not fused for PERMANENTLY INSTALLED ME EQUIPMENT	Not permanently installed equipment.	N/A
	– fuses or OVER-CURRENT RELEASES omitted due to provision of two MEANS OF PROTECTION between all parts of opposite polarity within MAINS PART, and between all parts of MAINS PART and earth, and such provisions continued within all components	--	N/A
	Effect of short-circuit fault conditions in other circuits taken into consideration before eliminating fuses or OVER-CURRENT RELEASES	--	N/A
	Protective devices have adequate breaking capacity to interrupt the maximum fault current including the available short-circuit	See appended Table 8.10	P
	A fuse or OVER-CURRENT RELEASE not provided in a PROTECTIVE EARTH CONDUCTOR	Not fused.	P
	Fuses complying with IEC 60127 have high breaking capacity (1 500 A) and prospective short-circuit current > 35 A or 10 times current rating of the fuse, whichever is greater	High breaking primary fuses F1, F2 incorporated within the power supply.	P
	Justification for omission of fuses or OVER-CURRENT RELEASES is in RISK MANAGEMENT FILE	--	N/A

IEC 60601-1			
Clause	Requirement + Test	Result - Remark	Verdict
8.11.6	Internal wiring of the MAINS PART		P
	a) Cross-sectional area of internal wiring in a MAINS PART between MAINS TERMINAL DEVICE and protective devices is not less than minimum required for POWER SUPPLY CORD as in clause 8.11.3.3 (mm ² Cu)..... :	Primary fuses incorporated within approved appliance inlet.	N/A
	b) Cross-sectional area of other wiring in MAINS PART and sizes of tracks on printed wiring circuits sufficient to prevent fire in case of fault currents..... :	See appended Table 8.10	P
	When necessary, ME EQUIPMENT connected to a SUPPLY MAINS with max available short-circuit fault, and subsequent simulation of a fault in a single insulation in MAINS PART did not result in any of the HAZARDOUS SITUATIONS in 13.1.2	--	N/A
9	PROTECTION AGAINST MECHANICAL HAZARDS OF ME EQUIPMENT AND ME SYSTEMS		P
9.1	ME EQUIPMENT complies with Clause 4 for design and manufacture, and mechanical strength (15.3)	--	P
9.2	HAZARDS associated with moving parts		N/A
9.2.1	When ME EQUIPMENT with moving parts PROPERLY INSTALLED, used per ACCOMPANYING DOCUMENTS or under foreseeable misuse, RISKS associated with moving parts reduced to an acceptable level..... :	See Appended RM Results Table 9.2.1 Only two ventilation fans provided. All cables are protected with the contact with ventilation blades. No other moving parts.	N/A
	RISK from contact with moving parts reduced to an acceptable level using protective measures, (access, function, shape of parts, energy, speed of motion, and benefits to PATIENT considered)	--	N/A
	RESIDUAL RISK associated with moving parts considered acceptable when exposure was needed for ME EQUIPMENT to perform its function	--	N/A
	Warnings marked on ME EQUIPMENT or included in instructions for use when HAZARDS persisted after implementing all reasonable protective measures..... :	See provided Marking Labels	N/A
9.2.2	TRAPPING ZONE		N/A

IEC 60601-1			
Clause	Requirement + Test	Result - Remark	Verdict
9.2.2.1	ME EQUIPMENT with a TRAPPING ZONE complied with one or more of the following as feasible:	EUT is medical power supply unit for building in. No trapping zones.	N/A
	– Gaps in Clause 9.2.2.2, or	--	N/A
	– Safe distances in Clause 9.2.2.3, or	--	N/A
	– GUARDS and protective measures in 9.2.2.4, or	--	N/A
	– Continuous activation in Clause 9.2.2.5	--	N/A
	Control of relevant motion complied with 9.2.2.6 when implementation of above protective measures were inconsistent with INTENDED USE of ME EQUIPMENT or ME SYSTEM	--	N/A
9.2.2.2	A TRAPPING ZONE considered not to present a MECHANICAL HAZARD when gaps of TRAPPING ZONE complied with dimensions per Table 20 . :	See appended Table 9.2.2.2	N/A
9.2.2.3	A TRAPPING ZONE considered not to present a MECHANICAL HAZARD when distances separating OPERATOR, PATIENT, and others from TRAPPING ZONES exceeded values in ISO 13852	See appended Table 9.2.2.2	N/A
	Distances measured from expected positions of OPERATOR, PATIENT, and others near EQUIPMENT in NORMAL USE or under foreseeable misuse	--	N/A
9.2.2.4	GUARDS and protective measures		N/A
9.2.2.4.1	A TRAPPING ZONE considered not to present a MECHANICAL HAZARD when GUARDS and protective measures were of robust construction, not easy to bypass or render non-operational, and did not introduce additional unacceptable RISK based on results of applicable tests in 15.3 for ENCLOSURES..... :	See Appended Table 15.3	N/A
9.2.2.4.2	FIXED GUARDS held in place by systems that cannot be dismantled without a TOOL	--	N/A
9.2.2.4.3	Movable GUARDS that can be opened without a TOOL remained attached when GUARD was open	See Appended RM Results Table 9.2.2.4.3	N/A
	– they are associated with an interlock preventing relevant moving parts from starting to move while TRAPPING ZONE is accessible, and stops movement when the GUARD is opened,	--	N/A
	– absence or failure of one of their components prevents starting, and stops moving parts	--	N/A
	Movable GUARDS complied with all applicable tests as confirmed by review of RISK MANAGEMENT FILE	--	N/A

IEC 60601-1			
Clause	Requirement + Test	Result - Remark	Verdict
9.2.2.4.4	Protective measures provided in control system prevented moving parts from starting to move while in reach of persons	See Appended RM Results Table 9.2.2.4.4	N/A
	– protective measures prevented TRAPPING ZONE from reach, or, when it was reached, system movement stopped once ME EQUIPMENT started to move, and in the latter case, no HAZARD or damage resulted	--	N/A
	– when protective measure was in a SINGLE FAULT CONDITION, and an unacceptable RISK could arise, one or more emergency stopping device(s) provided	--	N/A
	RISK MANAGEMENT FILE reviewed and all conditions confirmed	--	N/A
9.2.2.5	Continuous activation		N/A
	TRAPPING ZONE not considered to present a MECHANICAL HAZARD where impractical to make TRAPPING ZONE inaccessible when:	--	N/A
	a) movement was in OPERATOR'S field of view	--	N/A
	b) movement of ME EQUIPMENT or its parts was possible only by continuous activation of control by OPERATOR as long as OPERATOR response to deactivate device relied upon to prevent HARM	--	N/A
	Manually operated movements complied with this clause since mass and velocity allowed adequate control of positioning without causing an unacceptable RISK	--	N/A
	c) when in a SINGLE FAULT CONDITION of continuous activation system an unacceptable RISK could arise, one or more emergency stopping device(s) provided in ME EQUIPMENT ..:	See Appended RM Results Table 9.2.2.5 c)	N/A
9.2.2.6	Speed of movement(s) positioning parts of ME EQUIPMENT or PATIENT, when contact with ME EQUIPMENT could result in a HAZARDOUS SITUATION, limited to allow OPERATOR control of positioning without resulting in an unacceptable RISK	See Appended RM Results Table 9.2.2.6	N/A
	Over travel (stopping distance) of such movement occurring after operation of a control to stop movement, did not result in an unacceptable RISK	--	N/A
9.2.3	Other HAZARDS associated with moving parts		N/A
9.2.3.1	Controls positioned, recessed, or protected by other means and could not be accidentally actuated to result in unacceptable RISK, except when ergonomic considerations for a PATIENT with special needs require otherwise	--	N/A

IEC 60601-1			
Clause	Requirement + Test	Result - Remark	Verdict
9.2.3.2	RISK due to over travel (past range limits) of ME EQUIPMENT parts reduced to an acceptable level, and stops or other means with mechanical strength to withstand intended loading in NORMAL USE and foreseeable misuse provided limiting measure in NORMAL and SINGLE FAULT CONDITION..... :	See appended Table 8.10 and Appended RM Results Table 9.2.3.2	N/A
9.2.4	Emergency stopping devices		N/A
	Where necessary to have one or more emergency stopping device(s), emergency stopping device complied with all the following, except for actuating switch capable of interrupting all power	See Appended RM Results Table 9.2.4 No emergency stopping device provided.	N/A
	a) Emergency stopping device reduced RISK to an acceptable level	--	N/A
	b) Proximity and response of OPERATOR to actuate emergency stopping device could be relied upon to prevent HARM	--	N/A
	c) Emergency stopping device actuator was readily accessible to OPERATOR	--	N/A
	d) Emergency stopping device(s) are not part of normal operation of ME EQUIPMENT	--	N/A
	e) Emergency switching operation or stopping means neither introduced further HAZARD nor interfered with operation necessary to remove original HAZARD	--	N/A
	f) Emergency stopping device was able to break full load of relevant circuit, including possible stalled motor currents and the like	--	N/A
	g) Means for stopping of movements operate as a result of one single action	--	N/A
	h) Emergency stopping device provided with an actuator in red and easily distinguishable and identifiable from other controls	--	N/A
	i) An actuator interrupting/opening mechanical movements marked on or immediately adjacent to face of actuator with symbol 18 of Table D.1 (symbol IEC 60417-5638, DB:2002-10) or "STOP"	--	N/A
	j) Emergency stopping device, once actuated, maintained ME EQUIPMENT in disabled condition until a deliberate action, different from that used to actuate it, was performed	--	N/A
	k) Emergency stopping device is suitable for its application	--	N/A

IEC 60601-1			
Clause	Requirement + Test	Result - Remark	Verdict
9.2.5	Means provided to permit quick and safe release of PATIENT in event of breakdown of ME EQUIPMENT or failure of power supply, activation of a protective measure, or emergency stopping, and	See Appended RM Results Table 9.2.5	N/A
	– Uncontrolled or unintended movement of ME EQUIPMENT that could result in an unacceptable RISK prevented	--	N/A
	– Situations where PATIENT is subjected to unacceptable RISKS due to proximity of moving parts, removal of normal exit routes, or other HAZARDS prevented	--	N/A
	– Measures provided to reduce RISK to an acceptable level when after removal of counterbalanced parts, other parts of ME EQUIPMENT can move in a hazardous way	--	N/A
9.3	Rough surfaces, sharp corners and edges of ME EQUIPMENT that could result in an unacceptable RISK avoided or covered	See Appended RM Results Table 9.3 Corners properly protected with insulation foil. No rough surfaces or sharp edges.	P
9.4	Instability HAZARDS		N/A
9.4.1	ME EQUIPMENT, other than FIXED and hand-held, for placement on a surface did not overbalance (tip over) or move unexpectedly, to the degree that it could present an unacceptable RISK to PATIENT, or OPERATOR as tested in 9.4.2 to 9.4.4	EUT for building-in.	N/A
9.4.2	Instability – overbalance		N/A
9.4.2.1	ME EQUIPMENT or its parts did not overbalance when prepared per ACCOMPANYING DOCUMENTS, or when not specified, as in 9.4.2.2, and placed on a 10° inclined plane from horizontal consisting of a hard and flat surface (e.g., concrete floor covered with 2 to 4 mm thick vinyl material)	See Appended Table 9.4.2.1	N/A
9.4.2.2	Instability excluding transport		N/A
	ME EQUIPMENT or its parts prepared based on a) to g), inclusive, did not overbalance when placed in different positions of NORMAL USE, except transport positions, on a 5° inclined plane from horizontal (hard and flat surface)	See Appended Table 9.4.2.2	N/A

IEC 60601-1			
Clause	Requirement + Test	Result - Remark	Verdict
	A warning provided, stating “Transport only under conditions described in instructions for use or marked on ME EQUIPMENT with an indication of RESIDUAL RISK if ME EQUIPMENT or its parts overbalances” when overbalance occurred during 10° inclined plane test	--	N/A
9.4.2.3	Instability from horizontal and vertical forces		N/A
	a) ME EQUIPMENT with a mass of 25 kg or more, other than FIXED ME EQUIPMENT for use on floor, did not overbalance due to pushing or resting	Mass of equipment less than 25 kg. EUT for building-in.	N/A
	Surfaces of ME EQUIPMENT where a RISK of overbalancing exists from pushing, leaning, resting etc., permanently marked with a CLEARLY LEGIBLE warning of the RISK (e.g., safety sign 5 of Table D.2, safety sign ISO 7010-P017)	--	N/A
	ME EQUIPMENT did not overbalance when placed on a horizontal plane, and a force of 25% of its weight, but not more than 220 N, applied in different directions, except a direction with an upward component	--	N/A
	b) ME EQUIPMENT, other than FIXED ME EQUIPMENT, for use on the floor or on a table, did not overbalance due to sitting or stepping, except when a legible warning of this RISK provided on ME EQUIPMENT (e.g., safety signs 6 and 7 of Table D.2, safety signs ISO 7010-P018, or ISO 7010-P019 as appropriate)	--	N/A
	ME EQUIPMENT did not overbalance when placed on a horizontal plane, and a constant force of 800 N applied at the point of maximum moment to working surfaces, offering an foothold or sitting surface of a min 20 x 20 cm area, and at a height ≤ 1 m from the floor :	See Appended Table 9.4.2.3	N/A
9.4.2.4	Castors and wheels		N/A
9.4.2.4.1	Means used for transportation of MOBILE ME EQUIPMENT (e.g., castors or wheels) did not result in an unacceptable RISK when MOBILE ME EQUIPMENT moved or parked in NORMAL USE	--	N/A
9.4.2.4.2	Force required to move MOBILE ME EQUIPMENT along a hard and flat horizontal surface did not exceed 200 N applied at a height of 1 m above floor or highest point on ME EQUIPMENT when < 1 m high, except when instructions indicated more than one person needed (N) ... :	See Appended Table 9.4.2.4.2	N/A

IEC 60601-1			
Clause	Requirement + Test	Result - Remark	Verdict
9.4.2.4.3	MOBILE ME EQUIPMENT exceeding 45 kg configured with a SAFE WORKING LOAD, moved 10 times in forward direction over a solid vertical plane obstruction with wheels impacting the obstruction at a speed of 0.4 m/s ± 0.1 m/s for manual or with max speed for motor driven MOBILE ME EQUIPMENT	See Appended Table 9.4.2.4.3	N/A
	ME EQUIPMENT went up the obstruction without overbalancing or any other unacceptable RISK as determined by examination of RISK MANAGEMENT FILE, ME EQUIPMENT and its parts.....	See Appended RM Results Table 9.4.2.3	N/A
	There was no reduction of CREEPAGE and CLEARANCES below 8.9, no access to parts exceeding limits in 8.4, and no access to moving parts capable of causing HARM, and	--	N/A
	– Assessment criteria in Clause 9 and 11.6 used	--	N/A
	– Dielectric strength test of 8.8.3 conducted to evaluate integrity of solid SUPPLEMENTARY or REINFORCED INSULATION	--	N/A
	– CREEPAGE DISTANCES and AIR CLEARANCES measured compared favourably with min distances in clause 8.9	--	N/A
	Small chips not adversely affecting protection against electric shock or moisture, disregarded	--	N/A
9.4.3	Instability from unwanted lateral movement (including sliding)		N/A
9.4.3.1	a) Brakes of power-driven MOBILE ME EQUIPMENT normally activated and could only be released by continuous actuation of a control	--	N/A
	b) MOBILE ME EQUIPMENT provided with locking means to prevent unwanted movements of ME EQUIPMENT or its parts in transport position	--	N/A
	c) No unacceptable RISK due to unwanted lateral movement resulted when MOBILE ME EQUIPMENT placed in its transport position or worst case NORMAL USE position with SAFE WORKING LOAD, and locking device activated, on a 10° inclined hard flat surface with castors in the worst-case position	--	N/A
	Following initial elastic movement, creepage, and pivoting of castors, no further movement of MOBILE ME EQUIPMENT > 50 mm (in relation to inclined plane) occurred (mm).....	See Appended Table 9.4.3.1	N/A
	RISK due to any initial movement assessed taking into consideration NORMAL USE of ME EQUIPMENT	--	N/A
9.4.3.2	Instability excluding transport		N/A

IEC 60601-1			
Clause	Requirement + Test	Result - Remark	Verdict
	a) Further movement of ME EQUIPMENT (after initial elastic movement) was less than 50 mm when MOBILE ME EQUIPMENT with a SAFE WORKING LOAD positioned on a 5° inclined hard flat surface with wheel locked or braking system activated (mm)	See Appended Table 9.4.3.2	N/A
	RISK due to initial movements assessed taking into consideration NORMAL USE OF ME EQUIPMENT	--	N/A
	b) TRANSPORTABLE or STATIONARY ME EQUIPMENT for use on the floor and with a SAFE WORKING LOAD prepared as in 9.4.2.2 and placed on a horizontal plane with locking device activated and castors, when supplied, in their worst – case position	--	N/A
	Further movement of ME EQUIPMENT (after initial elastic movement), was no more than 50 mm when a force of 25 % of weight of unit, but less than 220 N, applied in different directions, except a direction with an upwards component, at highest point of ME EQUIPMENT but ≤ 1.5 m from floor	See Appended Table 9.4.3.2	N/A
	RISK due to initial movements assessed taking into consideration NORMAL USE OF ME EQUIPMENT	--	N/A
9.4.4	Grips and other handling devices		N/A
	a) ME EQUIPMENT other than PORTABLE EQUIPMENT or its part with a mass of over 20 kg requiring lifting in NORMAL USE or transport provided with suitable handling means, or ACCOMPANYING DOCUMENTS specify safe lifting method, except when handling is obvious and not causing HAZARDS	--	N/A
	Handles, when supplied, suitably placed to enable ME EQUIPMENT or its part to be carried by two or more persons and by examination of EQUIPMENT, its part, or ACCOMPANYING DOCUMENTS	--	N/A
	b) PORTABLE ME EQUIPMENT with a mass > 20 kg provided with one or more carrying-handles suitably placed to enable carrying by two or more persons as confirmed by actual carrying	--	N/A
	c) Carrying handles and grips and their means of attachment withstood loading test.....	See Appended Table 9.4.4	N/A
9.5	Expelled parts HAZARD		N/A
9.5.1	Suitability of means of protecting against unacceptable RISK of expelled parts determined by assessment and examination of RISK MANAGEMENT FILE	See Appended RM Results Table 9.5.1	N/A
9.5.2	Cathode ray tube(s) complied with IEC 60065:2001, Clause 18, or IEC 61965.....	See appended Table 8.10	N/A

IEC 60601-1			
Clause	Requirement + Test	Result - Remark	Verdict
9.6	Acoustic energy (including infra- and ultrasound) and vibration		N/A
9.6.1	Human exposure to acoustic energy and vibration from ME EQUIPMENT doesn't result in unacceptable RISK as confirmed in RISK MANAGEMENT FILE including audibility of auditory alarm signals, PATIENT sensitivity, and tests of 9.6.2 and 9.6.3	See Appended RM Results Table 9.6.1	N/A
9.6.2	Acoustic energy		N/A
9.6.2.1	PATIENT, OPERATOR, and other persons are not exposed to acoustic energy from ME EQUIPMENT in NORMAL USE, except for auditory alarm signals	--	N/A
	– 80 dBA for a cumulative exposure of 24 h over a 24 h period (dBA).....:	--	—
	- 83 dBA (when halving the cumulative exposure time) (dBA)	--	—
	– 140 dB un-weighted sound pressure level for impulsive or impact acoustic energy (dB).....:	--	—
9.6.2.2	RISK MANAGEMENT FILE examined for RISKS associated with infrasound or ultrasound, when present, addressed in RISK MANAGEMENT PROCESS	See Appended RM Results Table 9.6.2.2	N/A
9.6.3	Hand-transmitted vibration		N/A
	Means provided, except for INTENDED USE vibrations, to protect PATIENT and OPERATOR when hand-transmitted frequency-weighted r.m.s. acceleration generated in NORMAL USE exceeds specified values measured at points of hand contact with PATIENT or OPERATOR	--	N/A
	– 2.5 m/s ² for a cumulative time of 8 h during a 24 h period (m/s ²)	--	N/A
	– Accelerations for different times, inversely proportional to square root of time (m/s ²)	--	N/A
9.7	Pressure vessels and parts subject to pneumatic and hydraulic pressure		N/A
9.7.1	Requirements of this clause applied to vessels and parts of ME EQUIPMENT subject to pressure resulting in rupture and unacceptable RISK	--	N/A
	Parts of a pneumatic or hydraulic system used as a support system, comply with 9.8	--	N/A
9.7.2	Pneumatic and hydraulic parts of ME EQUIPMENT or ACCESSORIES met following requirements based on examination of RISK MANAGEMENT FILE	See Appended RM Results Table 9.7.2	N/A
	– No unacceptable RISK resulted from loss of pressure or loss of vacuum	--	N/A

IEC 60601-1			
Clause	Requirement + Test	Result - Remark	Verdict
	– No unacceptable RISK resulted from a fluid jet caused by leakage or a component failure	--	N/A
	– Elements of ME EQUIPMENT or an ACCESSORY, especially pipes and hoses leading to an unacceptable RISK protected against harmful external effects	--	N/A
	– Reservoirs and similar vessels leading to an unacceptable RISK are automatically depressurized when ME EQUIPMENT is isolated from its power supply	--	N/A
	Means provided for isolation, or local depressurizing reservoirs and similar vessels, and pressure indication when above not possible	--	N/A
	– All elements remaining under pressure after isolation of ME EQUIPMENT or an ACCESSORY from its power supply resulting in an unacceptable RISK provided with clearly identified exhaust devices, and a warning to depressurize these elements before setting or maintenance activity	--	N/A
9.7.3	Maximum pressure a part of ME EQUIPMENT can be subjected to in NORMAL and SINGLE FAULT CONDITIONS considered to be highest of following:	--	N/A
	a) RATED maximum supply pressure from an external source	--	N/A
	b) Pressure setting of a pressure-relief device provided as part of assembly	--	N/A
	c) Max pressure that can develop by a source of pressure that is part of assembly, unless pressure limited by a pressure-relief device	--	N/A
9.7.4	Max pressure in NORMAL and SINGLE FAULT CONDITIONS did not exceed MAXIMUM PERMISSIBLE WORKING PRESSURE for EQUIPMENT part, except as allowed in 9.7.7, confirmed by examination of ME EQUIPMENT and RISK MANAGEMENT FILE, and by functional tests..... :	See Appended RM Results Table 9.7.4	N/A
9.7.5	A pressure vessel withstood a HYDRAULIC TEST PRESSURE when pressure was > 50 kPa, and product of pressure and volume was more than 200 kPa..... :	See Appended Table 9.7.5	N/A
9.7.6	Pressure-control device regulating pressure in ME EQUIPMENT with pressure-relief device completed 100,000 cycles of operation under RATED load and prevented pressure from exceeding 90 % of setting of pressure-relief device in different conditions of NORMAL USE . :	See Appended RM Results Table 9.7.6	N/A

IEC 60601-1			
Clause	Requirement + Test	Result - Remark	Verdict
9.7.7	Pressure-relief device(s) used where MAXIMUM PERMISSIBLE WORKING PRESSURE could otherwise be exceeded met the following, as confirmed by MANUFACTURER'S data, ME EQUIPMENT, RISK MANAGEMENT FILE, and functional tests	See Appended RM Results Table 9.7.7	N/A
	a) Connected as close as possible to pressure vessel or parts of system it is to protect	--	N/A
	b) Installed to be readily accessible for inspection, maintenance, and repair	--	N/A
	c) Could be adjusted or rendered inoperative without a TOOL	--	N/A
	d) With discharge opening located and directed as to not to release material towards any person	--	N/A
	e) With discharge opening located and directed as to not to deposit material on parts that could result in an unacceptable RISK	--	N/A
	f) Adequate discharge capacity provided to ensure that pressure will not exceed MAXIMUM PERMISSIBLE WORKING PRESSURE of system it is connected to by more than 10 % when failure occurs in control of supply pressure	--	N/A
	g) No shut-off valve provided between a pressure-relief device and parts it is to protect	--	N/A
	h) Min number of cycles of operation 100 000, except for one-time use devices (bursting disks)	--	N/A
9.8	HAZARDS associated with support systems		N/A
9.8.1	ME EQUIPMENT parts designed to support loads or provide actuating forces when a mechanical fault could constitute an unacceptable RISK	See appended Table 8.10 and Appended RM Results Table 9.8.1	N/A
	– Construction of support, suspension, or actuation system complied with Table 21 and TOTAL LOAD	--	N/A
	– Means of attachment of ACCESSORIES prevent possibility of incorrect attachment that could result in an unacceptable RISK	--	N/A
	– RISK ANALYSIS of support systems included HAZARDS from static, dynamic, vibration, impact and pressure loading, foundation and other movements, temperature, environmental, manufacture and service conditions	--	N/A

IEC 60601-1			
Clause	Requirement + Test	Result - Remark	Verdict
	– RISK ANALYSIS included effects of failures such as excessive deflection, plastic deformation, ductile/brittle fracture, fatigue fracture, instability (buckling), stress-assisted corrosion cracking, wear, material creep and deterioration, and residual stresses from manufacturing PROCESSES	--	N/A
	– Instructions on attachment of structures to a floor, wall, ceiling, included in ACCOMPANYING DOCUMENTS making adequate allowances for quality of materials used to make the connection and list the required materials	--	N/A
	Additional instructions provided on checking adequacy of surface of structure parts will be attached to	--	N/A
9.8.2	Support systems maintain structural integrity during EXPECTED SERVICE LIFE, and TENSILE SAFETY FACTORS are not less than in Table 21, except when an alternative method used to demonstrate structural integrity throughout EXPECTED SERVICE LIFE, or for a foot rest	--	N/A
	Compliance with 9.8.1 and 9.8.2 confirmed by examination of ME EQUIPMENT, RISK MANAGEMENT FILE, specifications and material processing.. :	See Appended RM Results Table 9.8.2	N/A
	When test results were part of information, testing consisted of application of a test load to support assembly equal to TOTAL LOAD times required TENSILE SAFETY FACTOR while support assembly under test was in equilibrium after 1 min, or not resulted in an unacceptable RISK . :	See appended Table 8.10	N/A
9.8.3	Strength of PATIENT or OPERATOR support or suspension systems		N/A
9.8.3.1	ME EQUIPMENT parts supporting or immobilizing PATIENTS minimize RISK of physical injuries and accidental loosening of secured joints	See Appended RM Results Table 9.8.3.1	N/A
	SAFE WORKING LOAD of ME EQUIPMENT or its parts supporting or suspending PATIENTS or OPERATORS is sum of mass of PATIENTS or mass of OPERATORS plus mass of ACCESSORIES supported by ME EQUIPMENT or its parts	--	N/A
	Supporting and suspending parts for adult human PATIENTS or OPERATORS designed for a PATIENT or OPERATOR with a min mass of 135 kg and ACCESSORIES with a min mass of 15 kg, unless stated by MANUFACTURER	--	N/A
	Maximum mass of PATIENT included in SAFE WORKING LOAD of ME EQUIPMENT or its parts supporting or suspending PATIENTS adapted when MANUFACTURER specified applications	--	N/A

IEC 60601-1			
Clause	Requirement + Test	Result - Remark	Verdict
	Max allowable PATIENT mass < 135 kg marked on ME EQUIPMENT and stated in ACCOMPANYING DOCUMENTS	--	N/A
	Max allowable PATIENT mass > 135 kg stated in ACCOMPANYING DOCUMENTS	--	N/A
	Examination of markings, ACCOMPANYING DOCUMENTS, and RISK MANAGEMENT FILE confirmed compliance	See copy of Marking Label	N/A
9.8.3.2	Part of SAFE WORKING LOAD representing mass of PATIENTS or OPERATORS is distributed on support/suspension surface representing human body as in Fig A.19	--	N/A
	Part of SAFE WORKING LOAD representing mass of ACCESSORIES deployed as in NORMAL USE and, when not defined, at worst case position permitted by configuration or ACCESSORIES attachment on support/suspension parts	--	N/A
	a) Entire mass of PATIENT or OPERATOR distributed over an area of 0.1 m ² on a foot rest temporarily supporting a standing PATIENT or OPERATOR	See Appended RM Results Table 9.8.3.2 a)	N/A
	Compliance confirmed by examination of ME EQUIPMENT, RISK MANAGEMENT FILE, specifications of materials and their processing, and tests	See appended Table 8.10	N/A
	PATIENT support/suspension system positioned horizontally in most disadvantageous position in NORMAL USE, and a mass 2 x 135 kg or twice intended person's load (the greater used), applied to foot rest over an area of 0.1 m ² for 1 min (Kg).....	See appended Table 9.8.3.2	N/A
	Damage or deflection resulting in an unacceptable RISK did not occur on foot rest and its secured joints	--	N/A
	b) Deflection of a support surface from PATIENT or OPERATOR loading on an area of support/suspension where a PATIENT or OPERATOR can sit did not result in an unacceptable RISK.....	See Appended RM Results Table 9.8.3.2 b)	N/A
	Compliance confirmed by examination of ME EQUIPMENT, RISK MANAGEMENT FILE, specifications of materials and their processing, and by a test.....	See appended Table 8.10	N/A

IEC 60601-1			
Clause	Requirement + Test	Result - Remark	Verdict
	PATIENT support/suspension system set in most unfavourable NORMAL USE position, and a mass of 60 % of part of SAFE WORKING LOAD simulating PATIENT or OPERATOR, or a min 80 kg, placed on support or suspension system with centre of load 60 mm from outer edge of support or suspension system for at least one minute (Kg)..... :	See appended Table 9.8.3.2	N/A
	Deflection of support/suspension system resulting in an unacceptable RISK not occur	--	N/A
9.8.3.3	Dynamic forces that can be exerted on equipment parts supporting or suspending a PATIENT or OPERATOR in NORMAL USE did not result in an unacceptable RISK as confirmed by following test:	--	N/A
	PATIENT support/suspension system set in most unfavourable NORMAL USE position, and a mass equal to SAFE WORKING LOAD simulating PATIENT or OPERATOR dropped from 150 mm above seat area on an area of support/ suspension a PATIENT or OPERATOR can sit:	See appended Table 9.8.3.3	N/A
9.8.4	Systems with MECHANICAL PROTECTIVE DEVICES		N/A
9.8.4.1	a) A MECHANICAL PROTECTIVE DEVICE provided when a support system or its parts impaired by wear have a TENSILE SAFETY FACTOR \geq to values in Table 21, rows 5 and 6, but less than 3 and 4	See Appended RM Results Table 9.8.4.1	N/A
	b) MECHANICAL PROTECTIVE complies with the requirements as follows:	--	N/A
	– Designed based on TOTAL LOAD, and includes effects of SAFE WORKING LOAD when applicable	--	N/A
	– Has TENSILE SAFETY FACTORS for all parts not less than Table 21, row 7	--	N/A
	– Activated before travel (movement) produced an unacceptable RISK	--	N/A
	– Takes into account Clauses 9.2.5 and 9.8.4.3	--	N/A
	Compliance confirmed by examination of ME EQUIPMENT, RISK MANAGEMENT FILE, specifications of materials and their processing	See appended Table 8.10	N/A
9.8.4.2	Activation of MECHANICAL PROTECTIVE DEVICE is made obvious to OPERATOR when ME EQUIPMENT can still be used after failure of suspension or actuation means and activation of a MECHANICAL PROTECTIVE DEVICE (e.g., a secondary cable)	--	N/A

IEC 60601-1			
Clause	Requirement + Test	Result - Remark	Verdict
	MECHANICAL PROTECTIVE DEVICE requires use of a TOOL to be reset or replaced	--	N/A
9.8.4.3	MECHANICAL PROTECTIVE DEVICE intended to function once		N/A
	– Further use of ME EQUIPMENT not possible until replacement of MECHANICAL PROTECTIVE DEVICE	See Appended RM Results Table 9.8.4.3	N/A
	– ACCOMPANYING DOCUMENTS instruct once MECHANICAL PROTECTIVE DEVICE is activated, SERVICE PERSONNEL shall be called, and MECHANICAL PROTECTIVE DEVICE must be replaced before ME EQUIPMENT can be used	--	N/A
	– ME EQUIPMENT permanently marked with safety sign 2 of Table D.2 (i.e., safety sign 7010-W001)	--	N/A
	– Marking is adjacent to MECHANICAL PROTECTIVE DEVICE or its location relative to MECHANICAL PROTECTIVE DEVICE is obvious to service personnel	--	N/A
	– Compliance confirmed by examination of ME EQUIPMENT, ACCOMPANYING DOCUMENTS, RISK MANAGEMENT FILE, specifications and processing of materials, and following test.....:	See appended Table 8.10	N/A
	A chain, cable, band, spring, belt, jack screw nut, pneumatic or hydraulic hose, structural part or the like, employed to support a load, defeated by a convenient means causing maximum normal load to fall from most adverse position permitted by construction of ME EQUIPMENT	--	N/A
	Load included SAFE WORKING LOAD in 9.8.3.1 when system was capable of supporting a PATIENT or OPERATOR	--	N/A
	No evidence of damage to MECHANICAL PROTECTIVE DEVICE affecting its ability to perform its intended function	--	N/A
9.8.5	Systems without MECHANICAL PROTECTIVE DEVICES		N/A
	Support system parts have TENSILE SAFETY FACTORS \geq to values in Table 21, rows 1 and 2, and are not impaired by wear	See Appended RM Results Table 9.8.5	N/A
	Support system parts impaired by wear, however, they have TENSILE SAFETY FACTORS \geq to values in Table 21, rows 3 and 4	--	N/A
	Examination of ME EQUIPMENT and RISK MANAGEMENT FILE confirmed compliance	--	N/A
10	PROTECTION AGAINST UNWANTED AND EXCESSIVE RADIATION HAZARDS		N/A

IEC 60601-1			
Clause	Requirement + Test	Result - Remark	Verdict
10.1	X-Radiation		N/A
10.1.1	X-radiation dose-rate was $\leq 36 \mu\text{A/kg}$ ($5 \mu\text{Sv/h}$) (0.5 mR/h) 5 cm from surface of ME EQUIPMENT including background radiation for ME EQUIPMENT not producing therapeutic/diagnostic X-radiation but producing ionizing radiation .:	See Table 10.1.1 EUT not produces X-radiation.	N/A
	Amount of radiation measured by means of an ionizing chamber radiation monitor with an effective area of 10 cm^2 or by other instruments producing equal results	--	N/A
	ME EQUIPMENT operated as in NORMAL USE at most unfavourable RATED MAINS VOLTAGE and controls adjusted to emit maximum radiation	--	N/A
	Internal pre-set controls not intended for adjustment during EXPECTED SERVICE LIFE of ME EQUIPMENT not taken into consideration	--	N/A
10.1.2	RISK from unintended X-radiation from ME EQUIPMENT producing X-radiation for diagnostic and therapeutic purposes addressed in RISK MANAGEMENT PROCESS as indicated in RISK MANAGEMENT FILE (see IEC 60601-1-3 & 1.3)	See Appended RM Results Table 10.1.2	N/A
10.2	RISK associated with alpha, beta, gamma, neutron, and other particle radiation, when applicable, addressed in RISK MANAGEMENT PROCESS as shown in RISK MANAGEMENT FILE.....:	See Appended RM Results Table 10.2	N/A
10.3	RISK associated with microwave radiation, when applicable, addressed in RISK MANAGEMENT PROCESS as indicated in RISK MANAGEMENT FILE	See Appended RM Results Table 10.3	N/A
10.4	Relevant requirements of IEC 60825-1:1993 applied to lasers, light emitting diodes (LEDs), and laser light barriers or similar products	--	N/A
10.5	RISK associated with visible electromagnetic radiation other than emitted by lasers and LEDs, when applicable, addressed in RISK MANAGEMENT PROCESS as indicated in RISK MANAGEMENT FILE	See Appended RM Results Table 10.5	N/A
10.6	RISK associated with infrared radiation other than emitted by lasers and LEDs, as applicable, addressed in RISK MANAGEMENT PROCESS as indicated in RISK MANAGEMENT FILE	See Appended RM Results Table 10.6	N/A
10.7	RISK associated with ultraviolet radiation other than emitted by lasers and LEDs, as applicable, addressed in RISK MANAGEMENT PROCESS as indicated in RISK MANAGEMENT FILE	See Appended RM Results Table 10.7	N/A
11	PROTECTION AGAINST EXCESSIVE TEMPERATURES AND OTHER HAZARDS		P

IEC 60601-1			
Clause	Requirement + Test	Result - Remark	Verdict
11.1	Excessive temperatures in ME EQUIPMENT		P
11.1.1	Temperatures on ME EQUIPMENT parts did not exceed values in Tables 22 and 23 operating in worst-case NORMAL USE at maximum rated ambient operating temperature T	See appended Table 11.1.1 and appended RM Results Table 11.1.1 Power supply unit intended for building-in and is specified to be used outside the patient environment; therefore maximum allowed temperature of accessible parts determined from IEC/EN 60950-1 (Means of Operator Protection MOOP). The risk management requirements of the standard were not addressed.	P
	Surfaces of test corner did not exceed 90 °C	Test corner used.	P
	THERMAL CUT-OUTS did not operate in NORMAL CONDITION	Temperature regulation control not operated in normal conditions.	N/A
11.1.2	Temperature of APPLIED PARTS		N/A
11.1.2.1	Temperatures, hot or cold surfaces, and when appropriate, clinical effects of APPLIED PARTS supplying heat to a PATIENT determined and documented in RISK MANAGEMENT FILE and instructions for use	See appended Table 11.1.2.1 and appended RM Results Table 11.1.2.1 No applied parts.	N/A
11.1.2.2	APPLIED PARTS not supplying heat to a PATIENT met Table 24 with max surface temperatures > 41 °C disclosed in instructions for use, and clinical effects regarding maturity of PATIENTS, body surface, surface pressure, medications taken, as shown in RISK MANAGEMENT FILE	See appended Table 11.1.2.2 and appended RM Results Table 11.1.2.2	N/A
	Surfaces of APPLIED PARTS cooled below ambient temperatures that can also result in HAZARD evaluated as part of RISK MANAGEMENT PROCESS	--	N/A
11.1.3	Measurements not made when engineering judgment and rationale by MANUFACTURER indicated temperature limits could not exceed, as documented in RISK MANAGEMENT FILE	See appended Table 11.1.3 and RM Results Table 11.1.3 Temperature measurements performed.	N/A
	Test corner not used where engineering judgment and rationale by MANUFACTURER indicated test corner will not impact measurements, as documented in RISK MANAGEMENT FILE	Test corner used.	N/A

IEC 60601-1			
Clause	Requirement + Test	Result - Remark	Verdict
	Probability of occurrence and duration of contact for parts likely to be touched and for APPLIED PARTS documented in RISK MANAGEMENT FILE	The risk management requirements of the standard were not addressed. Power supply unit is intended for building-in. End product consideration.	N/A
11.1.4	GUARDS preventing contact with hot or cold accessible surfaces removable only with a TOOL	--	N/A
11.2	Fire prevention		N/A
11.2.1	ENCLOSURE has strength and rigidity necessary to prevent a fire caused by reasonably foreseeable misuse and met mechanical strength tests for ENCLOSURES in 15.3	End product shall provide necessary rigidity to prevent fire. Fire prevention is subject to end product investigation.	N/A
11.2.2	Me equipment and me systems used in conjunction with OXYGEN RICH ENVIRONMENTS		N/A
11.2.2.1	RISK of fire in an OXYGEN RICH ENVIRONMENT reduced by means limiting spread of fire under NORMAL or SINGLE FAULT CONDITIONS when source of ignition in contact with ignitable material ...:	See appended Table 8.10 EUT is not intended for use in conjunction with oxygen rich environment.	N/A
	Requirements of 13.1.1 applied to oxygen concentrations up to 25 % at one atmosphere or partial pressures up to 27.5 kPa for higher atmospheric pressures	--	N/A
	a) No sources of ignition discovered in an OXYGEN RICH ENVIRONMENT in NORMAL and SINGLE FAULT CONDITIONS under any of the following conditions	--	N/A
	1) when temperature of material raised to its ignition temperature	--	N/A
	2) when temperatures affected solder or solder joints causing loosening, short circuiting, or other failures causing sparking or increasing material temperature to its ignition temperature	--	N/A
	3) when parts affecting safety cracked or changed outer shape exposing temperatures higher than 300°C or sparks due to overheating	--	N/A
	4) when temperatures of parts or components exceeded 300°C, atmosphere was 100 % oxygen, contact material solder, and fuel cotton	--	N/A
	5) when sparks provided adequate energy for ignition by exceeding limits of Figs 35 to 37 (inclusive), atmosphere was 100 % oxygen, contact material solder, and fuel cotton	--	N/A

IEC 60601-1			
Clause	Requirement + Test	Result - Remark	Verdict
	Deviations from worst case limits in 4) and 5) above based on lower oxygen concentrations or less flammable fuels justified and documented in RISK MANAGEMENT FILE	See Appended RM Results Table 11.2.2.1	N/A
	Alternative test in this clause did not identify existence of ignition sources at highest voltage or current, respectively	See appended Table 11.2.2.1	N/A
	A safe upper limit determined by dividing upper limit of voltage or current, respectively, with safety margin factor of three.....	--	N/A
	b) RESIDUAL RISK of fire in an OXYGEN RICH ENVIRONMENT as determined by application of RISK MANAGEMENT PROCESS is based on following configurations, or in combination	See Appended RM Results Table 11.2.2.1	N/A
	1) Electrical components in an OXYGEN RICH ENVIRONMENT provided with power supplies having limited energy levels lower than those considered sufficient for ignition in 11.2.2.1 a) as determined by examination, measurement or calculation of power, energy, and temperatures in NORMAL and SINGLE FAULT CONDITIONS identified in 11.2.3.....	See appended Tables 4.11, 11.1.1 to 11.1.2.2, inclusive; and Table 13.2	N/A
	2) Max oxygen concentration measured until it did not exceed 25 % in ventilated compartments with parts that can be a source of ignition only in SINGLE FAULT CONDITION and can be penetrated by oxygen due to an undetected leak (%)	--	N/A
	3) A compartment with parts or components that can be a source of ignition only under SINGLE FAULT CONDITION separated from another compartment containing an OXYGEN RICH ENVIRONMENT by sealing all joints and holes for cables, shafts, or other purposes	--	N/A
	Effect of possible leaks and failures under SINGLE FAULT CONDITION that could cause ignition evaluated using a RISK ASSESSMENT to determine maintenance intervals by examination of documentation and RISK MANAGEMENT FILE.....	See Attachment #	N/A
	4) Fire initiated in ENCLOSURE of electrical components in a compartment with OXYGEN RICH ENVIRONMENT that can become a source of ignition only under SINGLE FAULT CONDITIONS self-extinguished rapidly and no hazardous amount of toxic gases reached PATIENT as determined by analysis of gases	See Attachment #	N/A

IEC 60601-1			
Clause	Requirement + Test	Result - Remark	Verdict
11.2.2.2	RISK of ignition under least favourable conditions did not occur and oxygen concentration did not exceed 25% in immediate surroundings due to location of external exhaust outlets of an OXYGEN RICH ENVIRONMENT when electrical components mounted outside of ME EQUIPMENT or ME SYSTEM	--	N/A
11.2.2.3	Electrical connections within a compartment containing an OXYGEN RICH ENVIRONMENT under NORMAL USE did not produce sparks due to loosening or breaking, except when limited in power and energy to values in 11.2.2.1 a) 5)	--	N/A
	– Screw-attachments protected against loosening during use by varnishing, use of spring washers, or adequate torques	--	N/A
	– Soldered, crimped, and pin-and-socket connections of cables exiting ENCLOSURE include additional mechanical securing means	--	N/A
11.2.3	SINGLE FAULT CONDITIONS related to OXYGEN RICH ENVIRONMENTS ME EQUIPMENT and ME SYSTEMS considered		N/A
	– Failure of a ventilation system constructed in accordance with 11.2.2.1 b) 2)	--	N/A
	– Failure of a barrier constructed in accordance with 11.2.2.1 b) 3)	--	N/A
	– Failure of a component creating a source of ignition (as defined in 11.2.2.1 a).....	--	N/A
	– Failure of solid insulation or creepage and clearances providing equivalent of at least one MEANS OF PATIENT PROTECTION but less than two MEANS OF PATIENT PROTECTION that could create a source of ignition defined in 11.2.2.1 a)	--	N/A
	– Failure of a pneumatic component resulting in leakage of oxygen-enriched gas	--	N/A
11.3	Constructional requirements for fire ENCLOSURES of ME EQUIPMENT		P
	ME EQUIPMENT met this clause for alternate means of compliance with selected HAZARDOUS SITUATIONS and fault conditions in 13.1.2	See Appended RM Results Table 11.3 Power supply is for building in. It is open frame construction and needs fire enclosure within the end product. Fire enclosure is end product consideration.	N/A
	Constructional requirements were met, or	Fire enclosure is end product consideration.	N/A
	- constructional requirements specifically analysed in RISK MANAGEMENT FILE	See Appended RM Results Table 11.3	N/A

IEC 60601-1			
Clause	Requirement + Test	Result - Remark	Verdict
	Justification, when requirement not met :	--	N/A
	a) Flammability classification of insulated wire within fire ENCLOSURE is FV-1, or better, based on IEC 60695 series as determined by examination of data on materials	See appended Table 8.10	N/A
	Flammability classification of connectors, printed circuit boards, and insulating material on which components are mounted is FV-2, or better, based on IEC 60695-11-10 as decided by examination of materials data :	See appended Table 8.10 PCB is rated UL94-V0.	P
	If no FV Certification, FV tests based on IEC 60695-11-10 conducted on 3 samples of complete parts (or sections of it), including area with min. thickness, ventilation openings	--	N/A
	b) Fire ENCLOSURE met following:	Fire enclosure is end product consideration.	N/A
	1) No openings at bottom or, as specified in Fig 39, constructed with baffles as in Fig 38, or made of perforated metal as in Table 25, or a metal screen with a mesh $\leq 2 \times 2$ mm centre to centre and wire diameter of at least 0.45 mm	--	N/A
	2) No openings on the sides within the area included within the inclined line C in Fig 39	--	N/A
	3) ENCLOSURE, baffles, and flame barriers have adequate rigidity and made of appropriate metal or of non-metallic materials, except constructions based on Table 25 and a mesh; FV-2 or better for TRANSPORTABLE ME EQUIPMENT, FV-1 or better for fixed EQUIPMENT, or STATIONARY EQUIPMENT per IEC 60695-11-10, determined by ENCLOSURE examination or flammability classification based on 11.3a)..... :	See appended Table 8.10	N/A
11.4	ME EQUIPMENT and ME SYSTEMS intended for use with flammable anaesthetics		N/A
	ME EQUIPMENT, ME SYSTEMS and parts described in ACCOMPANYING DOCUMENTS for use with flammable anaesthetics (CATEGORY AP) or anaesthetics with oxidants (CATEGORY APG) comply with Annex G	EUT is not intended for use with flammable anaesthetics.	N/A
11.5	ME EQUIPMENT and ME SYSTEMS intended for use in conjunction with flammable agents		N/A
	MANUFACTURER'S RISK MANAGEMENT PROCESS addresses possibility of fire and associated mitigations as confirmed by examination of RISK MANAGEMENT FILE :	See Appended RM Results Table 11.5	N/A
11.6	Overflow, spillage, leakage, ingress of water or particulate matter, cleaning, disinfection, sterilization and compatibility with substances used with the ME EQUIPMENT		N/A

IEC 60601-1			
Clause	Requirement + Test	Result - Remark	Verdict
11.6.1	Sufficient degree of protection provided against overflow, spillage, leakage, ingress of water or particulate matter, cleaning, disinfection and sterilization, and compatibility with substances used with ME EQUIPMENT :	See Appended Table 11.6.1	N/A
11.6.2	Overflow in ME EQUIPMENT	--	N/A
	Liquid reservoir liable to overflow in NORMAL USE completely filled and 15 % of its capacity poured in for over 1 min, and except when restricted, TRANSPORTABLE ME EQUIPMENT tilted through an angle of 15° in least favourable direction(s), and when necessary refilled starting from position of NORMAL USE :	See Appended RM Results Table 11.6.2 and Table 11.6	N/A
	ME EQUIPMENT met dielectric strength and LEAKAGE CURRENT tests and uninsulated electrical parts or electrical insulation of parts that could result in a HAZARDOUS SITUATION were not wet..... :	See appended Table 8.7 and 8.8.3	N/A
11.6.3	Spillage on ME EQUIPMENT and ME SYSTEM	No liquid use.	N/A
	ME EQUIPMENT and ME SYSTEMS handling liquids in NORMAL USE positioned as in 5.4 a) and liquid with composition, volume, duration of spill, point of contact, and test conditions based on RISK MANAGEMENT PROCESS poured steadily on a point on top of ME EQUIPMENT..... :	See Appended RM Results Table 11.6.3 and Table 11.6	N/A
	ME EQUIPMENT met dielectric strength and LEAKAGE CURRENT tests and uninsulated electrical parts or electrical insulation of parts that could result in a HAZARDOUS SITUATION were not wet :	See appended Tables 8.7 8.8.3	N/A
11.6.4	Leakage	See 13.2.6 No liquids used during normal use of the equipment.	N/A
11.6.5	Ingress of water or particulate matter into ME EQUIPMENT and ME SYSTEMS		N/A
	ME EQUIPMENT with IP Code placed in least favourable position of NORMAL USE and subjected to tests of IEC 60529 (IP Code) :	See Appended RM Results Table 11.6.5 and Table 11.6	N/A
	ME EQUIPMENT met dielectric strength and LEAKAGE CURRENT tests and there were no bridging of insulation or electrical components that could result in a HAZARDOUS SITUATION in NORMAL CONDITION or in a SINGLE FAULT CONDITION	See appended Tables 8.7 8.8.3	N/A
11.6.6	Cleaning and disinfection of ME EQUIPMENT and ME SYSTEMS		N/A

IEC 60601-1			
Clause	Requirement + Test	Result - Remark	Verdict
	ME EQUIPMENT/ME SYSTEM and their parts and ACCESSORIES cleaned or disinfected once using methods specified in instructions for use including any cooling or drying period :	See Appended RM Results Table 11.6.6 and Table 11.6 Cleaning or disinfection process not specified by the manufacturer. EUT is medical power supply unit for building-in.	N/A
	ME EQUIPMENT met dielectric strength and LEAKAGE CURRENT tests, with no deterioration resulting in an unacceptable RISK present :	See appended Tables 8.7 8.8.3	N/A
	Effects of multiple cleanings/disinfections during EXPECTED SERVICE LIFE of EQUIPMENT evaluated by MANUFACTURER and assurance that no unacceptable RISK will occur verified by RISK MANAGEMENT FILE review..... :	See RM Results Table 11.6.6	N/A
11.6.7	Sterilization of ME EQUIPMENT and ME SYSTEMS		N/A
	ME EQUIPMENT, ME SYSTEMS and their parts or ACCESSORIES intended to be sterilized assessed and documented according to ISO 11134, ISO 11135, or ISO 11137 as appropriate :	See Appended RM Results Table 11.6.7	N/A
	After the test, ME EQUIPMENT complied with the appropriate dielectric strength and LEAKAGE CURRENT tests and there was no deterioration resulting in an unacceptable RISK :	See appended Tables 8.7 8.8.3, and 11.6	N/A
11.6.8	RISKS associated with compatibility of substances used with ME EQUIPMENT addressed in RISK MANAGEMENT PROCESS as confirmed by examination of RISK MANAGEMENT FILE..... :	See Appended RM Results Table 11.6.8	N/A
11.7	ME EQUIPMENT, ME SYSTEM, and ACCESSORIES coming into direct or indirect contact with biological tissues, cells, or body fluids assessed and documented per ISO 10993	No such parts.	N/A
11.8	Interruption and restoration of power supply did not result in a HAZARDOUS SITUATION, except interruption of its intended function	Shall be evaluated during end medical product approval.	N/A

12	ACCURACY OF CONTROLS AND INSTRUMENTS AND PROTECTION AGAINST HAZARDOUS OUTPUTS		N/A
12.1	RISKS associated with accuracy of controls and instruments stated in RISK MANAGEMENT PROCESS confirmed by RISK MANAGEMENT FILE review :	See Appended RM Results Table 12.1	N/A
12.2	RISK of poor USABILITY, including identification, marking, and documents addressed in a USABILITY ENGINEERING PROCESS as confirmed by review of provided records..... :	See Report based on IEC 60601-1-6	N/A

IEC 60601-1			
Clause	Requirement + Test	Result - Remark	Verdict
12.3	The need for alarm systems as a means of RISK CONTROL and RISKS associated with operation or failure of alarm system addressed in RISK MANAGEMENT PROCESS	See Report based on IEC 60601-1-8 and appended RM Results Table 12.3 No alarm incorporated.	N/A
12.4	Protection against hazardous output		N/A
12.4.1	RISKS associated with hazardous output arising from intentional exceeding of safety limits addressed in RISK MANAGEMENT PROCESS as confirmed in RISK MANAGEMENT FILE.....	See Appended RM Results Table 12.4.1 Switch mode power supply unit is intended for building in the end medical product. Equipment provides five outputs. Those outputs shall not be accessible by the user and are only used for supplying end medical product by its output voltages. The RM requirements of the standard were not addressed.	N/A
12.4.2	When applicable, need for indication of parameters associated with hazardous output addressed in RISK MANAGEMENT PROCESS as confirmed in RISK MANAGEMENT FILE.....	See Appended RM Results Table 12.4.2	N/A
12.4.3	RISKS associated with accidental selection of excessive output values for ME EQUIPMENT with a multi-purpose unit designed to provide low and high-intensity outputs for different treatments addressed in RISK MANAGEMENT PROCESS, confirmed in RISK MANAGEMENT FILE ...	See Appended RM Results Table 12.4.3 Power supply is for building in. Mismatch between outputs is prevented by different types of connectors used.	N/A
12.4.4	When applicable, RISKS associated with incorrect output addressed in RISK MANAGEMENT PROCESS as confirmed by review of RISK MANAGEMENT FILE	See Appended RM Results Table 12.4.4	N/A
12.4.5	Diagnostic or therapeutic radiation		N/A
12.4.5.1	Adequate provisions to protect OPERATORS, PATIENTS, other persons and sensitive devices in vicinity of unwanted or excessive radiation emitted by ME EQUIPMENT designed to produce radiation for diagnostic/therapeutic purposes	--	N/A
	Radiation safety ensured by compliance with requirements of appropriate standards	--	N/A
12.4.5.2	RISKS associated with diagnostic X-rays addressed in RISK MANAGEMENT PROCESS as confirmed in RISK MANAGEMENT FILE.....	See IEC 60601-1-3 Report and appended RM Results Table 12.4.5.2	N/A

IEC 60601-1			
Clause	Requirement + Test	Result - Remark	Verdict
12.4.5.3	RISKS associated with radiotherapy addressed in RISK MANAGEMENT PROCESS as confirmed by review of RISK MANAGEMENT FILE	See Appended RM Results Table 12.4.5.3	N/A
12.4.5.4	RISKS associated with ME EQUIPMENT producing diagnostic or therapeutic radiation other than diagnostic X-rays and radiotherapy addressed in RISK MANAGEMENT PROCESS as confirmed by examination of RISK MANAGEMENT FILE.....	See Appended RM Results Table 12.4.5.4	N/A
12.4.6	When applicable, RISKS associated with diagnostic or therapeutic acoustic pressure addressed in RISK MANAGEMENT PROCESS as confirmed in RISK MANAGEMENT FILE	See Appended RM Results Table 12.4.6	N/A

13	HAZARDOUS SITUATIONS AND FAULT CONDITIONS		P
13.1	Specific HAZARDOUS SITUATIONS		P
13.1.1	None of HAZARDOUS SITUATIONS in 13.1.2-13.1.4, inclusive, occurred when SINGLE FAULT CONDITIONS applied, one at a time, as in 4.7 and 13.2	No hazardous situations occur during single fault testing.	P
13.1.2	Emissions, deformation of ENCLOSURE or exceeding maximum temperature		P
	– Emission of flames, molten metal, poisonous or ignitable substance in hazardous quantities did not occur	Not occur during single fault testing.	P
	– Deformation of ENCLOSURE impairing compliance with 15.3.1 did not occur	Metal enclosure provided.	P
	– Temperatures of APPLIED PARTS did not exceed allowable values in Table 24 when measured as in 11.1.3.....	See appended Tables 11.1.1, 11.1.2.1, and 11.1.2.2	N/A
	– Temperatures of ME EQUIPMENT parts that are not APPLIED PARTS likely to be touched did not exceed values in Table 23 when measured and adjusted as in 11.1.3.....	See appended Tables 11.1.1, 11.1.2.1, and 11.1.2.2	N/A
	–Allowable values for “other components and materials” in Table 22 times 1.5 minus 12.5 °C were not exceeded	Considered.	P
	Limits for windings in Tables 26, 27, and 31 not exceeded	Temperature of transformer windings not exceeded.	P
	Table 22 not exceeded in all other cases	--	P
	Temperatures measured according to 11.1.3	--	P
	SINGLE FAULT CONDITIONS in 4.7, 8.1 b), 8.7.2, and 13.2.2 relative to emission of flames, molten metal, or ignitable substances, not applied to parts and components where:	Single faults performed. EUT is power supply for building in. All internal components are mounted on the PCB made by material UL94-V0.	P

IEC 60601-1			
Clause	Requirement + Test	Result - Remark	Verdict
	– Supply circuit was unable to supply 15 W one minute after 15 W drawn from supply circuit, or	See appended Table 13.1.2	N/A
	– Parts and components completely contained within a fire ENCLOSURE complying with 11.3 as verified by review of design documentation	--	N/A
	After tests of this Clause, settings of THERMAL CUT-OUTS and OVER-CURRENT RELEASES did not change sufficiently to affect their safety function	--	N/A
13.1.3	– limits for LEAKAGE CURRENT in SINGLE FAULT CONDITION based on 8.7.3 did not exceed	See appended Table 8.7	P
	– voltage limits for ACCESSIBLE PARTS including APPLIED PARTS in 8.4.2 did not exceed.....	See appended Table 8.4.2	P
13.1.4	ME EQUIPMENT complied with the requirements of 9.1 to 9.8 for specific MECHANICAL HAZARDS	--	P
13. 2	SINGLE FAULT CONDITIONS		P
13.2.1	During application of SINGLE FAULT CONDITIONS in 13.2.2 -13.2.13, inclusive, NORMAL CONDITIONS in 8.1 a) applied in least favourable combination :	See appended Table 13.2	P
13.2.2 – 13.2.12	ME EQUIPMENT complied with 13.2.2 -13.2.12	See appended Table 13.2 and RM Results Table 13.2.6	P
13.2.13	ME EQUIPMENT remained safe after tests of 13.2.13.2 to 13.2.13.4 (inclusive), and cooling down to room temperature	--	N/A
	ME EQUIPMENT examined for compliance or appropriate tests such as dielectric strength of motor insulation according to 8.8.3 conducted	--	N/A
	For insulation of thermoplastic materials relied upon as a MEANS OF PROTECTION (see 8.8), the ball-pressure test specified in 8.8.4.1 a) performed at a temperature 25 °C higher than temperature of insulation measured during tests of 13.2.13.2 to 13.2.13.4 (inclusive).	--	N/A
13.2.13.2	ME EQUIPMENT with heating elements		N/A
	a 1) thermostatically controlled ME EQUIPMENT with heating elements for building-in, or for unattended operation, or with a capacitor not protected by a fuse connected in parallel with THERMOSTAT contacts met tests of 13.2.13.2 b) & 13.2.13.2 c)	No heating elements provided.	N/A
	a 2) ME EQUIPMENT with heating elements RATED for non-CONTINUOUS OPERATION met tests of 13.2.13.2 b) and 13.2.13.2 c)	--	N/A
	a 3) other ME EQUIPMENT with heating elements met test of 13.2.13.2 b)	--	N/A

IEC 60601-1			
Clause	Requirement + Test	Result - Remark	Verdict
	When more than one test was applicable to same ME EQUIPMENT, tests performed consecutively	--	N/A
	Heating period stopped when a heating element or an intentionally weak part of a non-SELF-RESETTING THERMAL CUT-OUT ruptured, or current interrupted before THERMAL STABILITY without possibility of automatic restoration	--	N/A
	Test repeated on a second sample when interruption was due to rupture of a heating element or an intentionally weak part	--	N/A
	Both samples met 13.1.2, and open circuiting of a heating element or an intentionally weak part in second sample not considered a failure by itself	--	N/A
	b) ME EQUIPMENT with heating elements tested per 11.1 without adequate heat discharge, and supply voltage set at 90 or 110 % of RATED supply voltage, least favourable of the two (V) : :	--	N/A
	Operating period stopped when a non-SELF-RESETTING THERMAL CUT-OUT operated, or current interrupted without possibility of automatic restoration before THERMAL STABILITY	--	N/A
	ME EQUIPMENT switched off as soon as THERMAL STABILITY established and allowed to cool to room temperature when current not interrupted	--	N/A
	Test duration was equal to RATED operating time for non-CONTINUOUS OPERATION	--	N/A
	c) Heating parts of ME EQUIPMENT tested with ME EQUIPMENT operated in NORMAL CONDITION at 110 % of RATED supply voltage and as in 11.1, and	--	N/A
	1) Controls limiting temperature in NORMAL CONDITION disabled, except THERMAL CUT-OUTS	--	N/A
	2) When more than one control provided, they were disabled in turn	--	N/A
	3) ME EQUIPMENT operated at RATED DUTY CYCLE until THERMAL STABILITY achieved, regardless of RATED operating time	--	N/A
13.2.13.3	ME EQUIPMENT with motors		N/A
	a 1) For the motor part of the ME EQUIPMENT, compliance checked by tests of 13.2.8- 13.2.10, 13.2.13.3 b), 13.2.13.3 c), and 13.2.13.4, as applicable	No motors provided.	N/A

IEC 60601-1			
Clause	Requirement + Test	Result - Remark	Verdict
	To determine compliance with 13.2.9 and 13.2.10 motors in circuits running at 42.4 V peak a.c./ 60 V d.c. or less are covered with a single layer of cheesecloth which did not ignite during the test	--	N/A
	a 2) Tests on ME EQUIPMENT containing heating parts conducted at prescribed voltage with motor & heating parts operated simultaneously to produce the least favourable condition	--	N/A
	a 3) Tests performed consecutively when more tests were applicable to the same ME EQUIPMENT	--	N/A
	b) Motor met running overload protection test of this clause when:	--	N/A
	1) it is intended to be remotely or automatically controlled by a single control device with no redundant protection, or	--	N/A
	2) it is likely to be subjected to CONTINUOUS OPERATION while unattended	--	N/A
	Motor winding temperature determined during each steady period and maximum value did not exceed Table 27 (Insulation Class, Maximum temperature measured °C)	--	N/A
	Motor removed from ME EQUIPMENT and tested separately when load could not be changed in appropriate steps	--	N/A
	Running overload test for motors operating at 42.4 V peak a.c./60 V d.c. or less performed only when examination and review of design indicated possibility of an overload	--	N/A
	Test not conducted where electronic drive circuits maintained a substantially constant drive current	--	N/A
	Test not conducted based on other justifications (justification)	--	N/A
	c) ME EQUIPMENT with 3-phase motors operated with normal load, connected to a 3-phase SUPPLY MAINS with one phase disconnected, and periods of operation per 13.2.10	--	N/A
13.2.13.4	ME EQUIPMENT RATED for NON-CONTINUOUS OPERATION		N/A
	ME EQUIPMENT (other than HAND-HELD) operated under normal load and at RATED voltage or at upper limit of RATED voltage range until increase in temperature was ≤ 5 °C in one hour, or a protective device operated	EUT is designed for continuous operation.	N/A
	When a load-reducing device operated in NORMAL USE, test continued with ME EQUIPMENT running idle	--	N/A

IEC 60601-1			
Clause	Requirement + Test	Result - Remark	Verdict
	Motor winding temperatures did not exceed values in 13.2.10	--	N/A
	Insulation Class	--	—
	Maximum temperature measured (°C).....	--	—

14	PROGRAMMABLE ELECTRICAL MEDICAL SYSTEMS (PEMS)		N/A
14.1	Requirements of this clause not applied to PEMS when it provided no BASIC SAFETY or ESSENTIAL PERFORMANCE, or	EUT is not programmable electrical medical system.	N/A
	- when application of ISO 14971 showed that failure of PEMS does not lead to unacceptable RISK	See Appended RM Results Table 14.1	N/A
	Every PROCESS has been followed throughout the PEMS DEVELOPMENT LIFE-CYCLE and a RECORD of PROCESS has been made available as confirmed by RISK MANAGEMENT FILE REVIEW and assessment of PROCESSES cited in this Clause	--	N/A
	MANUFACTURER considered the need for additional RISK CONTROL measures when unable to follow all PROCESSES identified in Clause 14 for each constituent component of PEMS as confirmed by RISK MANAGEMENT FILE review and assessment of PROCESSES cited in this Clause	--	N/A
	Assessment of PROCESSES cited in this Clause made by internal audits	--	N/A
14.2	Documents produced from application of Clause 14 are maintained and form a part of RISK MANAGEMENT FILE in addition to RECORDS and documents required by ISO 14971	--	N/A
14.3	RISK MANAGEMENT plan required by 3.5 of ISO 14971 includes reference to PEMS VALIDATION plan	--	N/A
14.4	A PEMS DEVELOPMENT LIFE-CYCLE including a set of defined milestones has been documented	--	N/A
	At each milestone, activities to be completed, and VERIFICATION methods to be applied to activities have been defined	--	N/A
	Each activity including its inputs and outputs defined, and each milestone identifies RISK MANAGEMENT activities that must be completed before that milestone	--	N/A
	PEMS DEVELOPMENT LIFE-CYCLE tailored for a specific development by making plans detailing activities, milestones, and schedules	--	N/A
	PEMS DEVELOPMENT LIFE-CYCLE includes documentation requirements	--	N/A

IEC 60601-1			
Clause	Requirement + Test	Result - Remark	Verdict
14.5	A documented system for problem resolution within and between all phases and activities of PEMS DEVELOPMENT LIFE-CYCLE has been developed and maintained where appropriate	--	N/A
	Problem resolution system meets the prescribed criteria depending on type of product:	--	N/A
	– it is documented as a part of PEMS DEVELOPMENT LIFE-CYCLE	--	N/A
	– it allows reporting of potential or existing problems affecting BASIC SAFETY or ESSENTIAL PERFORMANCE	--	N/A
	– it includes an assessment of each problem for associated RISKS	--	N/A
	– it identifies criteria that must be met for the issue to be closed	--	N/A
	– it identifies the action to be taken to resolve each problem	--	N/A
14.6	RISK MANAGEMENT PROCESS		N/A
14.6.1	MANUFACTURER considered HAZARDS associated with software and hardware aspects of PEMS including NETWORK/DATA COUPLING, components of third-party origin, legacy subsystems when compiling list of known or foreseeable HAZARDS	See Appended RM Results Table 14.6.1	N/A
	In addition to the material in ISO 14971, Annex D, list of possible sources for HAZARDS associated with PEMS includes specified causes	--	N/A
	– failure of NETWORK/DATA COUPLING to provide characteristics necessary for PEMS to achieve its BASIC SAFETY or ESSENTIAL PERFORMANCE	--	N/A
	– undesired feedback [physical and data] (such as unsolicited/ out of range/ inconsistent input or input from electromagnetic interference)	--	N/A
	– unavailable data	--	N/A
	– lack of integrity of data	--	N/A
	– incorrect data	--	N/A
	– incorrect timing of data	--	N/A
	– unintended interactions within & among PESS	--	N/A
	– unknown aspects or quality of third-party software	--	N/A
	– unknown aspects or quality of third-party PESS	--	N/A
	– lack of data security, particularly vulnerability to tampering, unintended interaction with other programs and viruses	--	N/A

IEC 60601-1			
Clause	Requirement + Test	Result - Remark	Verdict
14.6.2	Suitably validated tools and PROCEDURES assuring each RISK CONTROL measure reduces identified RISK(S) satisfactorily provided in addition to PEMS requirements in Clause 6.1 of ISO 14971..... :	See Appended RM Results Table 14.6.2	N/A
14.7	A documented requirement specification for PEMS and each of its subsystems (e.g. for a PESS) which includes ESSENTIAL PERFORMANCE and RISK CONTROL measures implemented by that system or subsystem :	See Appended RM Results Table 14.7	N/A
14.8	An architecture satisfying the requirement is specified for PEMS and each of subsystems :	See Appended RM Results Table 14.8	N/A
	The architecture specification makes use of considers the specified items to reduce RISK to an acceptable level, where appropriate:	--	N/A
	a) COMPONENTS WITH HIGH-INTEGRITY CHARACTERISTICS	--	N/A
	b) fail-safe functions	--	N/A
	c) redundancy	--	N/A
	d) diversity;	--	N/A
	e) partitioning of functionality	--	N/A
	f) defensive design potentially limiting hazardous effects by restricting available output power or by introducing means to limit travel of actuators	--	N/A
	g) allocation of RISK CONTROL measures to subsystems and components of PEMS	--	N/A
	h) failure modes of components and their effects;	--	N/A
	i) common cause failures	--	N/A
	j) systematic failures	--	N/A
	k) test interval duration and diagnostic coverage	--	N/A
	l) maintainability	--	N/A
	m) protection from reasonably foreseeable misuse	--	N/A
	n) NETWORK/DATA COUPLING specification, when applicable	--	N/A
14.9	Design is broken up into subsystems, each with a design and test specification where appropriate, and descriptive data on design environment included in RISK MANAGEMENT FILE:	See Appended RM Results Table 14.9	N/A

IEC 60601-1			
Clause	Requirement + Test	Result - Remark	Verdict
14.10	A VERIFICATION plan containing the specified information used to verify and document functions implementing BASIC SAFETY, ESSENTIAL PERFORMANCE, or RISK CONTROL measures	See Appended RM Results Table 14.10	N/A
	– milestone(s) when VERIFICATION is to be performed for each function	--	N/A
	– selection and documentation of VERIFICATION strategies, activities, techniques, and appropriate level of independence of the personnel performing the VERIFICATION	--	N/A
	– selection and utilization of VERIFICATION tools	--	N/A
	– coverage criteria for VERIFICATION	--	N/A
14.11	A PEMS VALIDATION plan containing validation of BASIC SAFETY & ESSENTIAL PERFORMANCE and requiring checks for unintended functioning of PEMS to perform and document PEMS VALIDATION	See Appended RM Results Table 14.11	N/A
	The person with overall responsibility for PEMS VALIDATION is independent of design team, and no member of a design team is responsible for PEMS VALIDATION of their own design	--	N/A
	All professional relationships of members of PEMS VALIDATION team with members of design team documented in RISK MANAGEMENT FILE providing methods & results of PEMS VALIDATION	--	N/A
14.12	Continued validity of previous design documentation assessed under a documented modification/change PROCEDURE	--	N/A
14.13	Technical description includes the following information when PEMS is to be connected to other equipment outside control of PEMS MANUFACTURER by NETWORK/DATA COUPLING.....:	See Appended RM Results Table 14.13	N/A
	a) characteristics of NETWORK/DATA COUPLING necessary for PEMS to achieve its INTENDED USE	--	N/A
	b) list of HAZARDOUS SITUATIONS resulting from a failure of NETWORK/DATA COUPLING to provide the specified characteristics	--	N/A
	c) instructions to RESPONSIBLE ORGANIZATION containing required information and warnings	--	N/A
	– connection of PEMS to a NETWORK/DATA COUPLING that includes other equipment could result in previously unidentified RISKS and RESPONSIBLE ORGANIZATION shall identify, analyze, and control such RISKS	--	N/A
	– subsequent changes to NETWORK/DATA COUPLING introducing new RISKS and requiring new analysis; and changes to NETWORK/DATA COUPLING include:	--	N/A

IEC 60601-1			
Clause	Requirement + Test	Result - Remark	Verdict
	– NETWORK/DATA COUPLING configuration change	--	N/A
	– connection of additional items to NETWORK/DATA COUPLING	--	N/A
	– disconnecting items from NETWORK/DATA COUPLING	--	N/A
	– update of equipment connected to NETWORK/DATA COUPLING	--	N/A
	– upgrade of equipment connected to NETWORK/DATA COUPLING	--	N/A

15	CONSTRUCTION OF ME EQUIPMENT		P
15.1	RISKS associated with arrangement of controls and indicators of ME EQUIPMENT addressed in RISK MANAGEMENT PROCESS, as confirmed by examination of RISK MANAGEMENT FILE	See Appended RM Results Table 15.1 No controls or indicators provided. End product consideration.	N/A
15.2	Parts of ME EQUIPMENT subject to mechanical wear, electrical, environmental degradation or ageing resulting in unacceptable RISK when unchecked for a long period, are accessible for inspection, replacement, and maintenance	No such parts provided.	N/A
	Inspection, servicing, replacement, and adjustment of parts of ME EQUIPMENT can easily be done without damage to or interference with adjacent parts or wiring	--	N/A
15.3	Mechanical strength		P
15.3.1	Mold stress relief, push, impact, drop, and rough handling tests did not result in unacceptable RISK and ME EQUIPMENT displayed adequate mechanical strength	--	P
15.3.2	Push test conducted by subjecting external parts of ENCLOSURE to a steady force of 250 N ± 10 N for 5 s applied to a circular (30mm) plane surface, except bottom of ENCLOSURE of an ME EQUIPMENT >18 kg, using a suitable test tool ... :	See Appended Table 15.3 and RM Results Table 15.3.2	P
	No damage resulting in an unacceptable RISK sustained as determined by examination of RISK MANAGEMENT FILE	No damage on the enclosure after push test. Power supply unit intended for building-in; therefore test performed only for reference.	N/A
15.3.3	Impact test conducted by subjecting a complete ENCLOSURE or its largest non-reinforced area, except for HAND-HELD ME EQUIPMENT and parts, to a free falling 500 g ± 25 g solid smooth steel ball, approx. 50 mm in diameter from a height of 1.3 m	See Appended Table 15.3 and RM Results Table 15.3.3	P

IEC 60601-1			
Clause	Requirement + Test	Result - Remark	Verdict
	Test not applied to flat panel displays, platen glass of ME EQUIPMENT, or cathode ray tubes	--	N/A
	No damage resulting in an unacceptable RISK sustained as shown in RISK MANAGEMENT FILE	No damage of the enclosure after impact test. Power supply unit intended for building-in; therefore test performed only for reference.	N/A
15.3.4	Drop test		N/A
15.3.4.1	Sample of HAND-HELD ME EQUIPMENT and HAND-HELD part with SAFE WORKING LOAD allowed to fall freely once from each of 3 different positions as in NORMAL USE from height specified in ACCOMPANYING DOCUMENTS, or from 1 m onto a 50 mm ± 5 mm thick hardwood board lying flat on a concrete or rigid base	See Appended Table 15.3 Unit for Building-in	N/A
	No unacceptable RISK resulted	--	N/A
15.3.4.2	Sample of PORTABLE ME EQUIPMENT and PORTABLE part with SAFE WORKING LOAD lifted to a height as in Table 29 above a 50 ± 5 mm thick hardwood board lying flat on a concrete floor or rigid base, dropped 3 times from each orientation in NORMAL USE (cm)	See Appended Table 15.3 and RM Table 15.3.4.2	N/A
	No damage resulting in an unacceptable RISK sustained as determined by examination of sample and RISK MANAGEMENT FILE	--	N/A
15.3.5	Each sample of MOBILE ME EQUIPMENT and MOBILE part with SAFE WORKING LOAD and in most adverse condition in NORMAL USE passed Rough Handling tests	See Appended Table 15.3 and RM Results Table 15.3.5	N/A
	a) Ascending step shock test conducted on the sample by pushing it 3 times in its normal direction of travel at 0.4 m/s ± 0.1 m/s against an ascending hardwood step obstruction without the sample going over the obstruction	--	N/A
	b) Descending step shock test conducted on the sample by pushing it 3 times in its normal direction of travel at 0.4 m/s ± 0.1 m/s in order to fall over a vertical step affixed flat on a rigid base with direction of movement perpendicular to face of the step until full descent achieved	--	N/A
	c) Door frame shock test conducted on the sample by moving it 3 times in its normal direction of travel at 0.4 m/s ± 0.1 m/s, or for motor driven EQUIPMENT, at maximum possible speed against a hardwood vertical obstacle higher than EQUIPMENT contact point(s)	--	N/A
	No damage resulting in an unacceptable RISK sustained as determined by examination of sample and RISK MANAGEMENT FILE	--	N/A

IEC 60601-1			
Clause	Requirement + Test	Result - Remark	Verdict
15.3.6	Examination of ENCLOSURE made from molded or formed thermoplastic material indicated that material distortion due to release of internal stresses by molding or forming operations will not result in an unacceptable RISK	--	N/A
	Mold-stress relief test conducted by placing one sample of complete ME EQUIPMENT, ENCLOSURE or a portion of larger ENCLOSURE, for 7 hours in a circulating air oven at 10°C over the max temperature measured on ENCLOSURE in 11.1.3, but no less than 70 °C	--	N/A
	No damage resulting in an unacceptable RISK	--	N/A
15.3.7	INTENDED USE, EXPECTED SERVICE LIFE, and conditions for transport and storage were taken into consideration for selection and treatment of materials used in construction of ME EQUIPMENT	--	N/A
	Based on review of EQUIPMENT, ACCOMPANYING DOCUMENTS, specifications and processing of materials, and MANUFACTURER'S relevant tests or calculations, corrosion, ageing, mechanical wear, degradation of biological materials due to bacteria, plants, animals and the like, will not result in an unacceptable RISK	--	N/A
15.4	ME EQUIPMENT components and general assembly		N/A
15.4.1	Incorrect connection of accessible connectors, removable without a TOOL, prevented where an unacceptable RISK exists, in particular	See Appended RM Results Table 15.4.1	N/A
	a) Plugs for connection of PATIENT leads cannot be connected to other outlets on same ME EQUIPMENT intended for other functions, except when RISK MANAGEMENT FILE provides proof that no unacceptable RISK could result	See attachment #	N/A
	b) Medical gas connections on ME EQUIPMENT for different gases to be operated in NORMAL USE are not interchangeable as verified by review of RISK MANAGEMENT FILE	See attachment #	N/A
15.4.2	Temperature and overload control devices		N/A
15.4.2.1	a) THERMAL CUT-OUTS and OVER-CURRENT RELEASES with automatic resetting not used in ME EQUIPMENT when their use could result in a HAZARDOUS SITUATION by resetting action as verified by review of RISK MANAGEMENT FILE	See Appended RM Results Table 15.4.2.1 a) No such components incorporated within the power supply unit.	N/A
	b) THERMAL CUT-OUTS with a safety function to be reset by a soldering operation affecting operating value not fitted in ME EQUIPMENT as verified by examination of design and RISK MANAGEMENT FILE	See Appended RM Results Table 15.4.2.1 b) No such component used.	N/A

IEC 60601-1			
Clause	Requirement + Test	Result - Remark	Verdict
	c) An independent non-SELF-RESETTING THERMAL CUT-OUT is, additionally, provided where a failure of a THERMOSTAT could constitute a HAZARD as verified by examination of design and RISK MANAGEMENT FILE.....:	See Appended RM Results Table 15.4.2.1 c) No thermostat provided.	N/A
	d) Based on design and RISK MANAGEMENT FILE review, loss of function of ME EQUIPMENT due to operation of THERMAL CUT-OUT or OVER CURRENT RELEASE doesn't result in a HAZARDOUS SITUATION	See Appended RM Results Table 15.4.2.1 d) EUT is not end medical product. The risk management requirements of the standard were not addressed. Shall be evaluated during end medical product approval.	N/E
	e) Capacitors or other spark-suppression devices not connected between contacts of THERMAL CUT-OUTS	--	N/A
	f) Use of THERMAL CUT-OUTS or OVER-CURRENT RELEASES do not affect safety of ME EQUIPMENT as verified by following tests:	No thermal cut outs used.	N/A
	Positive temperature coefficient devices (PTC's) complied with IEC 60730-1: 1999, clauses 15, 17, J.15, and J.17 as applicable	-	N/A
	ME EQUIPMENT containing THERMAL CUT-OUTS and OVER-CURRENT RELEASES operated under the conditions of Clause 13.....:	See appended Table 13.2	N/A
	SELF-RESETTING THERMAL CUT-OUTS and OVER-CURRENT RELEASES including circuits performing equivalent functions (other than PTC's) Certified according to appropriate standards...	--	N/A
	In the absence of Certification in accordance with IEC standards, SELF-RESETTING THERMAL CUT-OUTS and OVER-CURRENT RELEASES including circuits performing equivalent functions (other than PTC's) operated 200 times	--	N/A
	Manual reset THERMAL CUT-OUTS and OVER-CURRENT RELEASES Certified in accordance with appropriate IEC standards	No such components incorporated within the equipment.	N/A
	When certification based on IEC standards, or data from MANUFACTURER demonstrating reliability of component to perform its safety-related function is not available, manual reset THERMAL CUT-OUTS and OVER-CURRENT RELEASES operated 10 times	--	N/A
	Thermal protective devices tested separately from ME EQUIPMENT when engineering judgment indicated test results would not be impacted	No thermal protective devices incorporated.	N/A

IEC 60601-1			
Clause	Requirement + Test	Result - Remark	Verdict
	g) Protective device, provided on ME EQUIPMENT incorporating a fluid filled container with heating means, operated when heater switched on with container empty and prevented an unacceptable RISK due to overheating	--	N/A
	h) ME EQUIPMENT with tubular heating elements provided with protection against overheating in both leads where a conductive connection to earth could result in overheating as verified by review of design and RISK MANAGEMENT FILE :	See Appended RM Results Table 15.4.2.1 h)	N/A
15.4.2.2	Temperature settings clearly indicated when means provided to vary setting of THERMOSTATS	No thermostats incorporated.	N/A
15.4.3	Batteries		N/A
15.4.3.1	Battery housings from which gases can escape during charging or discharging likely to result in a HAZARD ventilated to minimize RISK of accumulation and ignition as verified by review of design and RISK MANAGEMENT FILE :	See Appended RM Results Table 15.4.3.1 No batteries inside power supply unit provided. Mains operated equipment.	N/A
	Battery compartments prevent accidental short circuiting of battery when this could result in a HAZARDOUS SITUATION as verified by examination of design and RISK MANAGEMENT FILE	--	N/A
15.4.3.2	Means provided to prevent incorrect connection of polarity when a HAZARDOUS SITUATION may develop by incorrect connection or replacement of a battery :	See Appended RM Results Table 15.4.3.2	N/A
15.4.3.3	Overcharging of battery prevented by virtue of design when it could result in an unacceptable RISK as verified by review of design :	See Appended RM Results Table 15.4.3.3	N/A
15.4.3.4	Lithium batteries that could become a HAZARD complied with appropriate tests of IEC 60086-4	See Appended RM Results Table 15.4.3.4	N/A
	Tests of IEC 60086-4 waived on the lithium battery based on examination of design	--	N/A
15.4.3.5	A properly RATED protective device provided within INTERNAL ELECTRICAL POWER SOURCE to protect against fire caused by excessive currents when (in case of a short circuit) layout of internal wiring, cross-sectional area, rating of connected components can result in a fire :	See Appended RM Results Table 15.4.3.5	N/A
	Protective device has adequate breaking capacity to interrupt the maximum fault current	--	N/A
	Justification for OVER-CURRENT RELEASES or FUSE exclusion is included in RISK MANAGEMENT FILE	--	N/A

IEC 60601-1			
Clause	Requirement + Test	Result - Remark	Verdict
15.4.4	Indicator lights provided to indicate ME EQUIPMENT is ready for NORMAL USE, except when apparent to OPERATOR from normal operating position, and marking of 7.4.1 are insufficient for this purpose	See Appended RM Results Table 15.4.4 Power supply unit is intended for building-in and provided without indicator lights. End product consideration. The risk management requirements of the standard were not addressed.	N/A
	An additional indicator light provided on ME EQUIPMENT with a stand-by state or a warm-up state exceeding 15 s, except when apparent to OPERATOR from normal operating position	--	N/A
	Indicator lights provided on ME EQUIPMENT incorporating non-luminous heaters to indicate heaters are operational when a HAZARDOUS SITUATION could exist, except when apparent to OPERATOR from normal operating position	No heaters provided.	N/A
	Requirement not applied to heated stylus-pens for recording purposes	--	N/A
	Indicator lights provided on ME EQUIPMENT to indicate an output exists where an accidental or prolonged operation of output circuit could constitute a HAZARDOUS SITUATION	No indicator lights provided.	N/A
	Colours of indicator lights complied with 7.8.1	--	N/A
	Charging mode visibly indicated in ME EQUIPMENT incorporating a means for charging an INTERNAL ELECTRICAL POWER SOURCE	No charging mode provided.	N/A
15.4.5	RISKS associated with pre-set controls addressed in RISK MANAGEMENT PROCESS when applicable as verified by review of RISK MANAGEMENT FILE	See Appended RM Results Table 15.4.5	N/A
15.4.6	Actuating parts of controls of ME EQUIPMENT		N/A
15.4.6.1	a) Actuating parts cannot be pulled off or loosened up during NORMAL USE	No actuating parts of controls provided.	N/A
	b) Indication of scales (e.g., "on" "off" positions, etc.) always corresponds to position of controls with adjustment that can result in a HAZARDOUS SITUATION for PATIENT or OPERATOR while ME EQUIPMENT is in use	--	N/A
	c) Incorrect connection of indicating device to relevant component prevented by adequate construction when it could be separated without use of a TOOL	--	N/A

IEC 60601-1			
Clause	Requirement + Test	Result - Remark	Verdict
	When torque values per Table 30 applied between control knob and shaft of rotating controls for not less than 2 s, 10 times in each direction, knobs did not rotate	See appended Table 15.4.6	N/A
	Tests conducted by applying an axial force of 60 N for electrical components and 100 N for other components for 1 min when an axial pull was required in NORMAL USE with no unacceptable RISK	See appended Table 15.4.6	N/A
15.4.6.2	Stops of adequate mechanical strength provided on rotating/ movable parts of controls of ME EQUIPMENT where necessary to prevent an unexpected change from max to min, or vice-versa, of the controlled parameter when this could cause a HAZARDOUS SITUATION	See appended Table 15.4.6	N/A
	Torque values in Table 30 applied 10 times in each direction to rotating controls for 2 sec ... :	See appended Table 15.4.6	N/A
	Application of an axial force of 60 N for electrical components and 100 N for other components to rotating or movable parts of controls for 1 min when an axial pull was required in NORMAL USE	See appended Table 15.4.6	N/A
15.4.7	Cord-connected HAND-HELD and foot-operated control devices		N/A
15.4.7.1	a) HAND-HELD control devices of ME EQUIPMENT complied with 15.3.4.1	EUT is not cord-connected hand-held or foot-operated control device.	N/A
	b) Foot-operated control device supported an actuating force of 1350 N for 1 min applied over an area of 30 mm diameter in its position of NORMAL USE with no damage to device causing an unacceptable RISK.....	--	N/A
15.4.7.2	Control device of HAND-HELD and foot-operated control devices turned in all possible abnormal positions and placed on a flat surface	--	N/A
	No unacceptable RISK caused by changing control setting when accidentally placed in an abnormal position	--	N/A
15.4.7.3	a) Foot-operated control device is at least IPX1 & complies with tests of IEC 60529 (IP Code) .. :	See appended Table 11.6 IP Code = ____	N/A
	b) ENCLOSURE of foot operated control devices containing electrical circuits is at least IPX6 and complies with IEC 60529 if in NORMAL USE liquids are likely to be found (IP Code)	See appended Table 11.6 and RM Results Table 15.4.7.3 b) IP Code = ____	N/A
	Probability of occurrence estimated as part of RISK MANAGEMENT PROCESS	--	N/A
15.4.8	Aluminium wires less than 16 mm ² in cross-sectional area are not used	Aluminium wires not used.	N/A

IEC 60601-1			
Clause	Requirement + Test	Result - Remark	Verdict
15.4.9	a) Oil container in PORTABLE ME EQUIPMENT allows for expansion of oil and is adequately sealed to prevent loss of oil in any position	--	N/A
	b) Oil containers in MOBILE ME EQUIPMENT sealed to prevent loss of oil during transport	--	N/A
	A pressure-release device operating during NORMAL USE is, optionally, provided	--	N/A
	c) Partially sealed oil-filled ME EQUIPMENT and its parts provided with means for checking the oil level to detect leakage	--	N/A
	ME EQUIPMENT and technical description examined, and manual tests conducted to confirm compliance with above requirements	--	N/A
15.5	MAINS SUPPLY TRANSFORMERS OF ME EQUIPMENT and transformers providing separation in accordance with 8.5		P
15.5.1	Overheating		P
15.5.1.1	Transformers of ME EQUIPMENT are protected against overheating in the event of short circuit or overload of output windings and comply with this Clause and tests of 15.5.1.2 – 3	See appended Tables 15.5.1.2 and 15.5.1.3	P
	During tests, windings did not open, no HAZARDOUS SITUATION occurred, and maximum temperatures of windings did not exceed values in Table 31	--	P
	Dielectric strength test of 8.8.3 conducted on transformer after short circuit and overload tests	See appended Table 15.5.2 Switch mode transformer incorporated within the equipment. Dielectric strength according to 8.8.3 performed.	N/A
15.5.1.2	Transformer output winding short circuited, and test continued until protective device operated or THERMAL STABILITY achieved	See appended Table 15.5.1.2	P
	Short circuit applied directly across output windings for transformers not tested according to 5X frequency and 5X voltage test of 15.5.2	--	P
15.5.1.3	Multiple overload tests conducted on windings with more than one protective device to evaluate worst-case NORMAL USE loading and protection.....	See appended Table 15.5.1.3	P
15.5.2	Transformer windings provided with adequate insulation to prevent internal short-circuits that could cause overheating which could result in a HAZARDOUS SITUATION	Switch mode transformers provided; therefore this test not relevant.	N/A

IEC 60601-1			
Clause	Requirement + Test	Result - Remark	Verdict
	Dielectric strength tests were conducted in accordance with requirements of this clause with no breakdown of insulation system and no detectable deterioration of transformer :	See appended Table 15.5.2	N/A
15.5.3	Transformers forming MEANS OF PROTECTION as required by 8.5 comply with IEC 61558-1:1997, Clause 5.12..... :	See appended Table 8.10 Transformer tested within the equipment.	P

16	ME SYSTEMS		N/A
16.1	After installation or subsequent modification, ME SYSTEM didn't result in an unacceptable RISK	See Appended RM Results Table 16.1 EUT is a component level power supply and therefore not treated as end ME system.	N/A
	Only HAZARDS arising from combining various equipment to form a ME SYSTEM considered	--	N/A
	– ME SYSTEM provides the level of safety within the PATIENT ENVIRONMENT equivalent to ME EQUIPMENT complying with this standard	--	N/A
	– ME SYSTEM provides the level of safety outside PATIENT ENVIRONMENT equivalent to equipment complying with their respective IEC or ISO safety standards	--	N/A
	– tests performed in NORMAL CONDITION, except as specified	--	N/A
	– tests performed under operating conditions specified by MANUFACTURER of ME SYSTEM	--	N/A
	Safety tests previously conducted on individual equipment of ME SYSTEM according to relevant standards not repeated	--	N/A
	RISK MANAGEMENT methods, optionally, used by MANUFACTURER of an ME SYSTEM reconfigurable by RESPONSIBLE ORGANIZATION or OPERATOR to determine configurations with highest RISKS and measures to ensure any configuration of ME SYSTEM will not present unacceptable RISKS	--	N/A
	Non-ME EQUIPMENT used in ME SYSTEM complied with applicable IEC or ISO safety standards	--	N/A
	Equipment relying only on BASIC INSULATION for protection against electric shock not used in ME SYSTEM	--	N/A
16.2	ACCOMPANYING DOCUMENTS of an ME SYSTEM		N/A

IEC 60601-1			
Clause	Requirement + Test	Result - Remark	Verdict
	Documents containing all data necessary for ME SYSTEM to be used as intended by MANUFACTURER including a contact address accompany ME SYSTEM or modified ME SYSTEM	--	N/A
	ACCOMPANYING DOCUMENTS regarded as a part of ME SYSTEM	--	N/A
	ACCOMPANYING DOCUMENTS are, optionally, provided in electronic format (e.g. electronic file format or CD ROM) and ME SYSTEM is capable of displaying or printing these documents	--	N/A
	a) ACCOMPANYING DOCUMENTS provided for each item of ME EQUIPMENT supplied by MANUFACTURER	--	N/A
	b) ACCOMPANYING DOCUMENTS provided for each item of non-ME EQUIPMENT supplied by MANUFACTURER	--	N/A
	c) the required information is provided:	--	N/A
	– specifications, instructions for use as intended by MANUFACTURER, and a list of all items forming the ME SYSTEM	--	N/A
	– instructions for installation, assembly, and modification of ME SYSTEM to ensure continued compliance with this standard	--	N/A
	– instructions for cleaning and, when applicable, disinfecting and sterilizing each item of equipment or equipment part forming part of the ME SYSTEM	--	N/A
	– additional safety measures to be applied during installation of ME SYSTEM	--	N/A
	– identification of parts of ME SYSTEM suitable for use within the PATIENT ENVIRONMENT	--	N/A
	– additional measures to be applied during preventive maintenance	--	N/A
	– a warning forbidding placement of MULTIPLE SOCKET-OUTLET, when provided and it is a separate item, on the floor	--	N/A
	– a warning indicating an additional MULTIPLE SOCKET-OUTLET or extension cord not to be connected to ME SYSTEM	--	N/A
	– a warning to connect only items that have been specified as part of ME SYSTEM or specified as being compatible with ME SYSTEM	--	N/A
	– maximum permissible load for any MULTIPLE SOCKET-OUTLET(S) used with ME SYSTEM	--	N/A

IEC 60601-1			
Clause	Requirement + Test	Result - Remark	Verdict
	– instructions indicating MULTIPLE SOCKET-OUTLETS provided with the ME SYSTEM to be used only for supplying power to equipment intended to form part of ME SYSTEM	--	N/A
	– an explanation indicating RISKS of connecting non-ME EQUIPMENT supplied as a part of ME SYSTEM directly to wall outlet when non-ME EQUIPMENT is intended to be supplied via a MULTIPLE SOCKET-OUTLET with a separating transformer	--	N/A
	– an explanation indicating RISKS of connecting any equipment supplied as a part of ME SYSTEM to MULTIPLE SOCKET-OUTLET	--	N/A
	– permissible environmental conditions of use for ME SYSTEM including conditions for transport and storage	--	N/A
	– instructions to OPERATOR not to, simultaneously, touch parts referred to in 16.4 and PATIENT	--	N/A
	d) the following instructions provided for use by RESPONSIBLE ORGANIZATION:	--	N/A
	– adjustment, cleaning, sterilization, and disinfection PROCEDURES	--	N/A
	– assembly of ME SYSTEMS and modifications during actual service life shall be evaluated based on the requirements of this standard	--	N/A
16.3	Instructions for use of ME EQUIPMENT intended to receive its power from other equipment in an ME SYSTEM, describe the other equipment to ensure compliance with these requirements	--	N/A
16.4	Parts of non-ME EQUIPMENT in PATIENT ENVIRONMENT subject to contact by OPERATOR during maintenance, calibration, after removal of covers, connectors, etc., without use of a TOOL operated at a voltage \leq voltage in 8.4.2 c) supplied from a source separated from SUPPLY MAINS by two MEANS OF OPERATOR PROTECTION	--	N/A
16.5	Safety measures incorporating a SEPARATION DEVICE applied when FUNCTIONAL CONNECTION between ME EQUIPMENT and other items of an ME SYSTEM or other systems can cause allowable values of LEAKAGE CURRENT to exceed	--	N/A
	SEPARATION DEVICE has dielectric strength, CREEPAGE and CLEARANCES required for one MEANS OF OPERATOR PROTECTION appropriate for highest voltage occurring across SEPARATION DEVICE during a fault condition	--	N/A

IEC 60601-1			
Clause	Requirement + Test	Result - Remark	Verdict
	WORKING VOLTAGE was highest voltage across SEPARATION DEVICE during a fault condition, but not less than MAXIMUM MAINS VOLTAGE (V) :	--	N/A
16.6	LEAKAGE CURRENTS		N/A
16.6.1	TOUCH CURRENT in NORMAL CONDITION, from or between parts of ME SYSTEM within the PATIENT ENVIRONMENT, did not exceed 100 µA..... :	See appended Table 16.6.1	N/A
	TOUCH CURRENT did not exceed 500 µA in event of interruption of any non-PERMANENTLY INSTALLED PROTECTIVE EARTH CONDUCTOR, from or between parts of ME SYSTEM within PATIENT ENVIRONMENT :	See appended Table 16.6.1	N/A
16.6.2	Current in PROTECTIVE EARTH CONDUCTOR of MULTIPLE SOCKET-OUTLET did not exceed 5 mA.. :	--	N/A
16.6.3	PATIENT LEAKAGE CURRENT and total PATIENT LEAKAGE CURRENT of ME SYSTEM in NORMAL CONDITION did not exceed values specified for ME EQUIPMENT in Tables 3 and 4 :	See appended Tables 8.7 8.7.4.7 and 16.6.1	N/A
	Measurements made using a device as in clause 8.7.4.4	--	N/A
16.7	ME SYSTEM complied with applicable requirements of Clause 9 when a MECHANICAL HAZARD existed..... :	See applicable appended Tables in section 9	N/A
16.8	Interruption and restoration of relevant power connections of ME SYSTEM one at a time and all connections simultaneously did not result in a HAZARDOUS SITUATION other than interruption of its intended function	--	N/A
16.9	ME SYSTEM connections and wiring		N/A
16.9.1	Incorrect connection of accessible connectors, removable without a TOOL, prevented where a HAZARDOUS SITUATION could otherwise exist..... :	See Appended RM Results Table 16.9.1	N/A
	– Connectors complied with Clause 15.4.1	--	N/A
	– Plugs for connection of PATIENT leads could not be connected to other outlets of the same ME SYSTEM likely to be located in PATIENT ENVIRONMENT, except when examination of connectors and interchanging them proved no HAZARDOUS SITUATION could result	--	N/A
16.9.2	MAINS PARTS, components and layout	--	N/A
16.9.2.1	a) – MULTIPLE SOCKET-OUTLET only allows connection using a TOOL, or	--	N/A
	– MULTIPLE SOCKET-OUTLET is of a type that cannot accept MAINS PLUGS of any of the kinds specified in IEC/TR 60083, or	--	N/A

IEC 60601-1			
Clause	Requirement + Test	Result - Remark	Verdict
	– MULTIPLE SOCKET-OUTLET is supplied via a separating transformer	--	N/A
	b) – MULTIPLE SOCKET-OUTLET marked with safety sign 2 of Table D.2 (i.e., safety sign ISO 7010-W001) visible in NORMAL USE, and	--	N/A
	– marked either individually or in combinations, with the maximum allowed continuous output in amperes or volt-amperes, or	--	N/A
	– marked to indicate the equipment or equipment parts it may safely be attached to	--	N/A
	– MULTIPLE SOCKET-OUTLET is a separate item or an integral part of ME EQUIPMENT or non-ME EQUIPMENT	--	N/A
	c) MULTIPLE SOCKET-OUTLET complied with IEC 60884-1 and the following requirements:	--	N/A
	– CREEPAGE and CLEARANCES complied with 8.9	--	N/A
	– It is CLASS I, and PROTECTIVE EARTH CONDUCTOR is connected to earthing contacts in socket-outlets	--	N/A
	– PROTECTIVE EARTH TERMINALS and PROTECTIVE EARTH CONNECTIONS comply with 8.6, except total impedance for ME SYSTEM was up to 400 mΩ, or higher when conditions of 8.6.4 b) met (mΩ).. :	--	N/A
	– ENCLOSURE complied with 8.4.2 d)	--	N/A
	– MAINS TERMINAL DEVICES and wiring complied with 8.11.4, when applicable	--	N/A
	– RATINGS of components are not in conflict with conditions of use	See appended Table 8.10	N/A
	– Electrical terminals and connectors of MULTIPLE SOCKET-OUTLETS prevent incorrect connection of accessible connectors removable without a TOOL	--	N/A
	– POWER SUPPLY CORD complied with 8.11.3	--	N/A
	d) Additional requirements applied when MULTIPLE SOCKET-OUTLET combined with a separating transformer:	--	N/A
	– Separating transformer complied with IEC 61558-2-1, except requirements of maximum RATED output power of 1 kVA and degree of protection IPX4 were not applied	See appended Table 8.10	N/A
	– Separating transformer is CLASS I	--	N/A
	– Degree of protection against ingress of water specified as in IEC 60529	--	N/A
	– Separating transformer assembly marked according to 7.2 and 7.3	--	N/A

IEC 60601-1			
Clause	Requirement + Test	Result - Remark	Verdict
	– MULTIPLE SOCKET-OUTLET permanently connected to separating transformer, or socket-outlet of separating transformer assembly cannot accept MAINS PLUGS as identified in IEC/TR 60083	--	N/A
16.9.2.2	Removal of any single item of equipment in ME SYSTEM will not interrupt the protective earthing of any other part without simultaneous disconnection of electrical supply to that part	--	N/A
	Additional PROTECTIVE EARTH CONDUCTORS can be detachable only by use of a TOOL	--	N/A
16.9.2.3	Conductors connecting different items within an ME SYSTEM protected against mechanical damage	--	N/A

17	ELECTROMAGNETIC COMPATIBILITY OF ME EQUIPMENT AND ME SYSTEMS		N/E
	RISKS associated with items addressed in RISK MANAGEMENT PROCESS as confirmed by review .:	See Appended RM Results Table 17 The risk management requirements of the standard were not addressed. EUT is switch mode power supply unit for building in. Electromagnetic compatibility shall be evaluated during end medical product approval.	N/E
	– electromagnetic phenomena at locations where ME EQUIPMENT or ME SYSTEM is to be used as stated in ACCOMPANYING DOCUMENTS.....:	--	N/E
	– introduction of electromagnetic phenomena into environment by ME EQUIPMENT or ME SYSTEM that might degrade performance of other devices, electrical equipment, and systems	-	N/E

ANNEX G	PROTECTION AGAINST HAZARDS OF IGNITION OF FLAMMABLE ANESTHETIC MIXTURES		N/A
G.2	Locations and basic requirements		N/A
G.2.1	Parts of CATEGORY APG ME EQUIPMENT in which a FLAMMABLE ANESTHETIC MIXTURE WITH AIR occurs are CATEGORY AP or APG ME EQUIPMENT and complied with G.3, G.4, and G.5	EUT was not tested against hazard of ignition of flammable anaesthetic mixtures.	N/A

IEC 60601-1			
Clause	Requirement + Test	Result - Remark	Verdict
G.2.2	FLAMMABLE AESTHETIC MIXTURE WITH AIR occurring due to a leakage or discharge of a FLAMMABLE AESTHETIC MIXTURE WITH OXYGEN or NITROUS OXIDE from an ENCLOSURE considered 5 to 25 cm from point of occurrence	--	N/A
G.2.3	A FLAMMABLE AESTHETIC MIXTURE WITH OXYGEN or NITROUS OXIDE contained in a completely / partly enclosed ME EQUIPMENT part and in PATIENT'S respiratory tract 5 cm from an ENCLOSURE part where leakage or discharge occurs	--	N/A
G.2.4	ME EQUIPMENT or parts thereof specified for use with FLAMMABLE AESTHETIC MIXTURE WITH AIR (in a location as in G.2.2) are CATEGORY AP or APG ME EQUIPMENT and complied with G.4 and G.5	--	N/A
G.2.5	ME EQUIPMENT or parts thereof for use with FLAMMABLE AESTHETIC MIXTURE WITH OXYGEN OR NITROUS OXIDE (location per G.2.2) are CATEGORY APG ME EQUIPMENT and comply with G.4 and G.6	--	N/A
	ME EQUIPMENT in G.2.3 to G.2.5 met appropriate tests of G.3-G.5 conducted after tests of 11.6.6 and 11.6.7	--	N/A
G.3	Marking, ACCOMPANYING DOCUMENTS		N/A
G.3.1	CATEGORY APG ME EQUIPMENT prominently marked. with a green-coloured band ≥ 2 cm wide with letters "APG" according to symbol 23 in Table D.1..... :	See copies of Marking Labels	N/A
	Length of green-coloured band is ≥ 4 cm, and size of marking is as large as possible for particular case	--	N/A
	When above marking not possible, relevant information included in instructions for use ... :	--	N/A
	Marking complied with tests and criteria of 7.1.2 and 7.1.3	--	N/A
G.3.2	CATEGORY AP ME EQUIPMENT prominently marked, with a green-coloured circle ≥ 2 cm in diameter, with characters "AP" according to symbol 22 in Table D.1..... :	See copies of Marking Labels	N/A
	Marking is as large as possible for the particular case	--	N/A
	When above marking not possible, the relevant information included in instructions for use ... :	--	N/A
	Marking complied with tests and criteria of 7.1.2 and 7.1.3	--	N/A

IEC 60601-1			
Clause	Requirement + Test	Result - Remark	Verdict
G.3.3	The marking according to G.3.2 and G.3.3 placed on major part of ME EQUIPMENT for CATEGORY AP or APG parts, and not repeated on detachable parts that can only be used with the marked EQUIPMENT	--	N/A
G.3.4	ACCOMPANYING DOCUMENTS contain an indication enabling the RESPONSIBLE ORGANIZATION to distinguish between CATEGORY AP and APG parts	--	N/A
G.3.5	Marking clearly indicates which parts are CATEGORY AP or APG when only certain ME EQUIPMENT parts are CATEGORY AP or APG	--	N/A
G.4	Common requirements for CATEGORY AP and CATEGORY APG ME EQUIPMENT		N/A
G.4.1	a) CREEPAGE and CLEARANCES between points of POWER SUPPLY CORD connection are according to Table 12 for one MEANS OF PATIENT PROTECTION	--	N/A
	b) Connections, except those in circuits described in G.5.3 and G.6.3, protected against accidental disconnection in NORMAL USE or connection and disconnection can be performed only with a TOOL	--	N/A
	c) CATEGORY AP and APG not provided with a DETACHABLE POWER SUPPLY CORD, except when circuit complied with G.5.3 and G.6.3	--	N/A
G.4.2	Construction details		N/A
	a) Opening of an ENCLOSURE providing protection against penetration of gases or vapours into ME EQUIPMENT or its parts possible only with a TOOL	--	N/A
	b) ENCLOSURE complies with requirements to minimize arcing and sparking due to penetration of foreign objects	See appended Table 8.10	N/A
	– no openings on top covers of ENCLOSURE, except for openings for controls covered by control knobs	--	N/A
	– openings in side-covers prevented penetration of a solid cylindrical test rod of 4 mm in diameter applied in all possible directions without appreciable force	--	N/A
	– openings in base plates prevented penetration of a solid cylindrical test rod of 12 mm in diameter applied in all directions without appreciable force	--	N/A

IEC 60601-1			
Clause	Requirement + Test	Result - Remark	Verdict
	c) Short circuiting conductor(s) to a conductive part without presence of explosive gasses where insulation may contact a part containing a FLAMMABLE AESTHETIC MIXTURE WITH OXYGEN or NITROUS OXIDE, ignitable gases alone, or oxygen, did not result in loss of integrity of the part, an unacceptable temperature, or other HAZARD	--	N/A
G.4.3	a) Electrostatic charges prevented on CATEGORY AP and APG ME EQUIPMENT by a combination of appropriate measures	--	N/A
	– Use of antistatic materials with a limited electrical resistance as specified in G.4.3 b) ... :	See appended Table 8.10	N/A
	– Provision of electrically conductive paths from ME EQUIPMENT or its parts to a conductive floor, protective earth or potential equalization system, or via wheels to an antistatic floor of medical room	--	N/A
	b) Electrical resistance limits of aesthetic tubing, mattresses and pads, castor tires, and other antistatic material complied with ISO 2882 based on measurements according to ISO 1853, ISO 2878 and ISO 23529..... :	--	N/A
G.4.4	Corona cannot be produced by components or parts of ME EQUIPMENT operating at more than 2000 V a.c. or 2400 V d.c. and not included in ENCLOSURES complying with G.5.4 or G.5.5	--	N/A
G.5	Requirements and tests for CATEGORY AP ME EQUIPMENT, parts and components		N/A
G.5.1	ME EQUIPMENT, its parts or components do not ignite FLAMMABLE AESTHETIC MIXTURES WITH AIR under NORMAL USE and CONDITIONS based on compliance with G.5.2 to G.5.5 (inclusive)	--	N/A
	Alternatively, ME EQUIPMENT, its parts, and components complied with requirements of IEC 60079-0 for pressurized ENCLOSURES (IEC 60079-2); for sand-filled ENCLOSURES, IEC 60079-5; or for oil immersed equipment, IEC 60079-6; and with this standard excluding G.5.2 to G.5.5..... :	--	N/A
G.5.2	ME EQUIPMENT, its parts, and components in contact with gas mixtures in NORMAL USE and CONDITIONS not producing sparks and not resulting in surface temperatures above 150 °C in case of restricted or 200 °C in case of unrestricted vertical air circulation measured at 25 °C comply with G.5.1..... :	See appended Tables 11.1.1, 11.1.2.1, 11.1.2.2, & 11.2.2.1	N/A
G.5.3	ME EQUIPMENT, its parts, and components producing sparks in NORMAL USE and CONDITION complied with temperature requirements of G.5.2, and U_{max} and I_{max} occurring in their circuits, and complied as follows:	--	N/A

IEC 60601-1			
Clause	Requirement + Test	Result - Remark	Verdict
	Measured $U_{max} \leq U_{zR}$ with I_{zR} as in Fig. G.1 :	$U_{max} = \underline{\quad} V$ $U_{zR} = \underline{\quad} V$ $I_{zR} = \underline{\quad} A$	N/A
	Measured $U_{max} \leq U_c$ with C_{max} as in Fig. G.2 :	$U_{max} = \underline{\quad} V$ $U_c = \underline{\quad} V$ $C_{max} = \underline{\quad} \mu F$	N/A
	Measured $I_{max} \leq I_{zR}$ with U_{zR} as in Fig G.1 :	$I_{max} = \underline{\quad} A$ $I_{zR} = \underline{\quad} A$ $U_{zR} = \underline{\quad} V$	N/A
	Measured $I_{max} \leq I_{zL}$ with L_{max} and a $U_{max} \leq 24 V$ as in Fig G.3..... :	$I_{max} = \underline{\quad} A$ $I_{zL} = \underline{\quad} A$ $L_{max} = \underline{\quad} mH$	N/A
	– Combinations of currents and corresponding voltages within the limitations $I_{zR} \cdot U_{zR} \leq 50 W$ extrapolated from Fig G.1	--	N/A
	No extrapolation made for voltages above 42 V	--	N/A
	– Combinations of capacitances and corresponding voltages within limitations of $C/2U^2 \leq 1.2 mJ$ extrapolated from Fig G.2	--	N/A
	No extrapolation made for voltages above 242V	--	N/A
	U_{max} , additionally, determined using actual resistance R when the equivalent resistance R was less than 8000 Ω	--	N/A
	– Combinations of currents and corresponding inductances within limitations $L/2I^2 \leq 0.3 mJ$ extrapolated from Fig G.3	--	N/A
	No extrapolation made for inductances larger than 900 mH	--	N/A
	– U_{max} was the highest supply voltage occurring in circuit under investigation with sparking contact open, taking into consideration MAINS VOLTAGE variations in 4.10	--	N/A
	– I_{max} was the highest current flowing in circuit under investigation with sparking contact closed, taking into consideration MAINS VOLTAGE variations required in 4.10	--	N/A
	– C_{max} and L_{max} taken as values occurring at the component under investigation producing sparks	--	N/A
	– Peak value considered when a.c. supplied	--	N/A
	– An equivalent circuit calculated to determine equivalent max capacitance, inductance, and equivalent U_{max} and I_{max} , either as d.c. or a.c. peak values in case of a complicated circuit...:	--	N/A

IEC 60601-1			
Clause	Requirement + Test	Result - Remark	Verdict
	Temperature measurements made according to 11.1, and U_{max} , I_{max} , R , L_{max} , and C_{max} determined with application of Figs G.1-G.3 .. :	See appended Tables 11.1.1, 11.1.2.1, & 11.1.2.2	N/A
	Alternatively, compliance was verified by examination of design data	--	N/A
G.5.4	External ventilation with internal overpressure		N/A
	ME EQUIPMENT, its parts, and components enclosed in an ENCLOSURE with external ventilation by means of internal overpressure complied with the following requirements:	--	N/A
	a) FLAMMABLE AESTHETIC MIXTURES WITH AIR that might have penetrated into ENCLOSURE of ME EQUIPMENT or part removed by ventilation before EQUIPMENT energized, and penetration of such mixtures during operation was prevented by maintenance of overpressure by means of air without flammable gases, or by physiologically acceptable inert gas (e.g., nitrogen)	--	N/A
	b) Overpressure inside ENCLOSURE was 75 Pa, min., in NORMAL CONDITION (Pa)	--	N/A
	Overpressure maintained at the site of potential ignition even when air or inert gas could escape through openings in ENCLOSURE necessary for normal operation of ME EQUIPMENT or its parts	--	N/A
	ME EQUIPMENT could be energized only after the required minimum overpressure was present long enough to ventilate the ENCLOSURE so that the displaced volume of air or inert gas was at least five times the volume of ENCLOSURE	--	N/A
	ME EQUIPMENT energized at will or repeatedly when overpressure was continuously present	--	N/A
	c) Ignition sources de-energized automatically by means used where G.4 does not apply, or complied with G.5 when during operation overpressure dropped below 50 Pa (Pa)	--	N/A
	d) External surface of ENCLOSURE in which internal overpressure was maintained did not exceed 150 °C in 25 °C ambient under NORMAL USE and CONDITION (°C)	--	N/A
G.5.5	ENCLOSURES with restricted breathing		N/A
	ME EQUIPMENT, its parts, and components enclosed in an ENCLOSURE with restricted breathing complied with the following:	--	N/A

IEC 60601-1			
Clause	Requirement + Test	Result - Remark	Verdict
	a) A FLAMMABLE AESTHETIC MIXTURE WITH AIR did not form inside ENCLOSURE with restricted breathing when it was surrounded by a FLAMMABLE AESTHETIC MIXTURE WITH AIR of a high concentration for at least 30 min without any pressure difference inside ENCLOSURE	--	N/A
	b) Gasket or sealing material used to maintain tightness complied with aging test B-b of IEC 60068-2-2, Clause 15, at 70 °C ± 2 °C and 96 h.:	See appended Table 8.10	N/A
	c) Gas-tightness of ENCLOSURE containing inlets for flexible cords maintained when the cords were stressed by bending or pulling	--	N/A
	Cords are fitted with adequate anchorages to limit stresses	--	N/A
	After the test in G.5.4 b), an internal overpressure of 400 Pa was created and 30 pulls of the value in Table G.1 applied to each flexible cord in axial direction of cord inlet and in the least favourable direction for 1 s	--	N/A
	Overpressure not reduced below 200 Pa	--	N/A
	Tests waived when examination of ENCLOSURE indicated it is completely sealed or gas-tight without a doubt (100 % degree of certainty)	--	N/A
	Operating temperature of external surface of ENCLOSURE was ≤ 150 °C in 25 °C (°C)	--	N/A
	Steady state operating temperature of ENCLOSURE also measured (°C)	--	N/A
G.6	CATEGORY APG ME EQUIPMENT, parts and components thereof		N/A
G.6.1	ME EQUIPMENT, its parts, and components did not ignite FLAMMABLE AESTHETIC MIXTURE WITH OXYGEN OR NITROUS OXIDE under NORMAL USE and SINGLE FAULT CONDITION	--	N/A
	ME EQUIPMENT, its parts, and components not complying with G.6.3 subjected to a CONTINUOUS OPERATION test after attaining thermal steady state (max. 3 h) over a period of 10 min in a 12.2 % ± 0.4 ether by volume/oxygen mixture	--	N/A
G.6.2	Parts and components of CATEGORY APG ME EQUIPMENT operating in a FLAMMABLE AESTHETIC MIXTURE WITH OXYGEN OR NITROUS OXIDE supplied from a source isolated from earth by insulation equal to one MEANS OF PATIENT PROTECTION and from electrical parts by insulation twice the MEANS OF PATIENT PROTECTION	--	N/A
G.6.3	Test of G.6.1 waived when the following requirements were met in NORMAL USE and under NORMAL and SINGLE FAULT CONDITIONS	--	N/A

IEC 60601-1			
Clause	Requirement + Test	Result - Remark	Verdict
	a) no sparks produced and temperatures did not exceed 90 °C, or	See Tables 11.1.1, 11.1.2.1, 11.1.2.2, 11.2.2.1, and 13.2	N/A
	b) a temperature limit of 90 °C not exceeded, sparks produced in NORMAL USE, and SINGLE FAULT CONDITIONS, except U_{max} and I_{max} occurring in their circuits complied with requirements, taking C_{max} and L_{max} into consideration:	See Tables 11.1.1, 11.1.2.1, 11.1.2.2, and 13.2	N/A
	Measured $U_{max} \leq U_{zR}$ with I_{zR} as in Fig. G.4 :	$U_{max} = \underline{\quad} V$ $U_{zR} = \underline{\quad} V$ $I_{zR} = \underline{\quad} A$	N/A
	Measured $U_{max} \leq U_{zC}$ with C_{max} as in Fig. G.5... :	$U_{max} = \underline{\quad} V$ $U_c = \underline{\quad} V$ $C_{max} = \underline{\quad} \mu F$	N/A
	Measured $I_{max} \leq I_{zR}$ with U_{zR} as in Fig G.4 :	$I_{max} = \underline{\quad} A$ $I_{zR} = \underline{\quad} A$ $U_{zR} = \underline{\quad} V$	N/A
	Measured $I_{max} \leq I_{zL}$ with L_{max} and a $U_{max} \leq 24 V$ as in Fig G.6 :	$I_{max} = \underline{\quad} A$ $I_{zL} = \underline{\quad} A$ $L_{max} = \underline{\quad} mH$	N/A
	– Extrapolation from Figs G.4, G.5, and G.6 was limited to areas indicated	--	N/A
	– U_{max} was the highest no-load voltage occurring in the circuit under investigation, taking into consideration mains voltage variations as in 4.10	--	N/A
	– I_{max} was the highest current flowing in the circuit under investigation, taking into account MAINS VOLTAGE variations as in 4.10	--	N/A
	– C_{max} and L_{max} are values occurring in relevant circuit	--	N/A
	– U_{max} additionally determined with actual resistance R when equivalent resistance R in Fig G.5 was less than 8000 Ω	--	N/A
	– Peak value taken into consideration when a.c. supplied	--	N/A
	– An equivalent circuit calculated to determine max capacitance, inductance, and U_{max} and I_{max} , either as d.c. or a.c. peak values in case of a complicated circuit :	--	N/A
	– When energy produced in an inductance or capacitance in a circuit is limited by voltage or current-limiting devices, two independent components applied, to obtain the required limitation even when a first fault (short or open circuit) in one of these components	--	N/A
	Above requirement not applied to transformers complying with this standard	--	N/A

IEC 60601-1			
Clause	Requirement + Test	Result - Remark	Verdict
	Above requirement not applied to wire-wound current-limiting resistors provided with a protection against unwinding of the wire in case of rupture	--	N/A
	Compliance verified by examination of CATEGORY APG ME EQUIPMENT, parts, and components , or	--	N/A
	Temperature measurements made in accordance with 11.1, or	See Tables 11.1.1, 11.1.2.1, and 11.1.2.2	N/A
	U_{max} , I_{max} , R , L_{max} and C_{max} determined together with application of Figs G.4-G.6	$U_{max} = \text{---} V$ $I_{max} = \text{---} A$ $R = \text{---} \Omega$ $L_{max} = \text{---} mH$ $C_{max} = \text{---} \mu F$	N/A
	Alternatively, compliance verified by comparison with design data	--	N/A
G.6.4	ME EQUIPMENT, its parts, and components heating a FLAMMABLE AESTHETIC MIXTURE WITH OXYGEN OR NITROUS OXIDE provided with a non-SELF-RESETTING THERMAL CUT-OUT and complied with 15.4.2.1	See appended Table 8.10	N/A
	Current-carrying part of heating element is not in direct contact with FLAMMABLE AESTHETIC MIXTURE WITH OXYGEN OR NITROUS OXIDE	--	N/A
G.7	Test apparatus for flammable mixtures		N/A
	Test apparatus used was in accordance with this Clause and Fig G.7	--	N/A

ANNEX L	INSULATED WINDING WIRES FOR USE WITHOUT INTERLEAVED INSULATION		P
L.1	BASIC, SUPPLEMENTARY, DOUBLE, and REINFORCED INSULATION in wound components without interleaved insulation complied with this Annex covering round winding wires between 0.05 mm and 5.00 mm diameters	Approved TIW used according to IEC 60851. See Table 8.10 for details.	P
L.2	Wire construction		N/A
	Overlap of layers when wire is insulated with two or more spirally wrapped layers of tape is adequate to ensure continued overlap during manufacture of wound component	--	N/A
	Layers of spirally wrapped wire insulation are sufficiently secured to maintain the overlap	--	N/A
L.3	Type Test		N/A
	The wire subjected to tests of L.3.1 to L.3.4 at a temperature and a relative humidity specified	--	N/A
	Temperature (°C)..... :	--	—

IEC 60601-1			
Clause	Requirement + Test	Result - Remark	Verdict
	Humidity (%)..... :	--	—
L.3.1	Dielectric strength		N/A
	Dielectric strength test of Clause 8.8.3 for the appropriate type and number of MOP(s) conducted by preparing the sample according to IEC 60851-5:1996, Clause 4.4.1 for a twisted pair with test voltages at least twice Tables 6 & 7, but not less than below with no breakdown:	--	N/A
	– 3000 V for BASIC and SUPPLEMENTARY INSULATION (V)..... :	--	N/A
	– 6000 V for REINFORCED INSULATION (V) :	--	N/A
L.3.2	Flexibility and adherence		N/A
	Sample subjected to flexibility and adherence test 8 of IEC 60851-3:1996, clause 5.1.1, using mandrel diameters of Table L.1	--	N/A
	Sample examined according to IEC 60851-3: 1997, clause 5.1.1.4, followed by dielectric test of clause 8.8.3, except test voltage applied between wire and mandrel with no breakdown	--	N/A
	Test voltage was at least the voltage in Tables 6 and 7but not less than the following:	--	N/A
	– 1500 V for BASIC and SUPPLEMENTARY INSULATION (V)..... :	--	N/A
	– 3000 V for REINFORCED INSULATION (V) :	--	N/A
	Tension applied to wire during winding on mandrel calculated from the wire diameter equivalent to 118 MPa ± 11.8 MPa :	--	N/A
L.3.3	Heat Shock		N/A
	Sample subjected to heat shock test 9 of IEC 60851-6:1996, followed by dielectric strength test of clause 8.8.3, except test voltage applied between the wire and mandrel	--	N/A
	Test voltage was at least the voltage in Tables 6 and 7, but not less than the following:	--	N/A
	– 1500 V for BASIC and SUPPLEMENTARY INSULATION (V)..... :	--	N/A
	– 3000 V for REINFORCED INSULATION (V) :	--	N/A
	Oven temperature based on Table L.2 (°C)..... :	--	—
	Mandrel diameter and tension applied as in clause L.3.2, (MPa; N/mm ²)..... :	--	N/A
	Dielectric strength test conducted at room temperature after removal from the oven	--	N/A
L.3.4	Retention of electric strength after bending		N/A

IEC 60601-1			
Clause	Requirement + Test	Result - Remark	Verdict
	Five samples prepared as in L.3.2 subjected to dielectric strength and bending tests	--	N/A
	Test voltage was at least the voltage in Tables 6 and 7, but not less than the following:	--	N/A
	– 1500 V for BASIC and SUPPLEMENTARY INSULATION (V)	--	N/A
	– 3000 V for REINFORCED INSULATION (V)	--	N/A
	Test voltage applied between the shot and conductor.	--	N/A
	Mandrel diameter and tension applied as in L.3.2, (MPa; N/mm ²).....	--	N/A
L.4	Tests during manufacture		N/A
L.4.1	Production line dielectric strength tests conducted by the manufacture according to L.4.2 and L.4.3	See attached manufacturer's routine testing verification	N/A
L.4.2	Test voltage for routine testing (100 % testing) is at least the voltage in Tables 6 and 7 but not less than the following:	--	N/A
	– 1500 V r.m.s. or 2100 V peak for BASIC and SUPPLEMENTARY INSULATION (V)	See manufacturer's routine testing verification	N/A
	– 3000 V r.m.s. or 4200 V peak for REINFORCED INSULATION (V).....	See manufacturer's routine testing verification	N/A
L.4.3	Sampling tests conducted using twisted pair samples (IEC 60851-5:1996, clause 4.4.1)	See manufacturer's routine testing verification	N/A
	Minimum breakdown test voltage at least twice the voltage in Tables 6 and 7 but not less than:	--	N/A
	– 3000 V r.m.s. or 4200 V peak for BASIC and SUPPLEMENTARY INSULATION	See manufacturer's routine testing verification	N/A
	– 6000 V r.m.s. or 8400 V peak for REINFORCED INSULATION	See manufacturer's routine testing verification	N/A

IEC 60601-1			
Clause	Requirement + Test	Result - Remark	Verdict

4.3	TABLE: ESSENTIAL PERFORMANCE		N/A
List of ESSENTIAL PERFORMANCE functions	MANUFACTURER'S document number reference or reference from this standard or collateral or particular standard(s)	Remarks	
Reinforced insulation between primary and secondary (2xMOOP) and basic insulation between primary and protective earth (1xMOOP).	--	Tested in accordance with IEC60601-1: 2005 to comply with MOOP requirements.	
<p>Supplementary Information:</p> <p>ESSENTIAL PERFORMANCE is performance, the absence or degradation of which, would result in an unacceptable risk.</p> <p>The risk management requirements of the standard were not addressed.</p> <p>EUT is not end medical product. All clauses required checking of RMF shall be evaluated during end medical product approval.</p> <p>Essential performance is performance, the absence or degradation of which, would result in an unacceptable risk.</p> <p>For the EUT essential performance is considered 2 x Means Of Operator Protection (2 x MOOP) which provided reinforced isolation to the operator with the equipment.</p>			

4.3	RM RESULTS TABLE: Essential Performance		N/E
Clause of ISO 14971	Document Ref. in RMF (Document No. & paragraph)	Result - Remarks	Verdict
4.2			
4.3			
4.4			
5			
<p>Supplementary information:</p> <p>The risk management requirements of the standard were not addressed.</p>			

4.5	RM RESULTS TABLE: Equivalent Safety for ME Equipment of ME System		N/E
Clause of ISO 14971	Document Ref. in RMF (Document No. & paragraph)	Result - Remarks	Verdict
4.2			
4.3			
4.4			
5			
6.2			
6.3			

IEC 60601-1			
Clause	Requirement + Test	Result - Remark	Verdict
4.5	RM RESULTS TABLE: Equivalent Safety for ME Equipment of ME System		N/E
Clause of ISO 14971	Document Ref. in RMF (Document No. & paragraph)	Result - Remarks	Verdict
6.4			
6.5			
Supplementary Information: The risk management requirements of the standard were not addressed.			

4.6	RM RESULTS TABLE: ME Equipment or system parts contacting the patient		N/A
Clause of ISO 14971	Document Ref. in RMF (Document No. & paragraph)	Result - Remarks	Verdict
4.2			
4.3			
4.4			
5			
6.2			
6.3			
6.4			
6.5			
Supplementary Information: No parts that can come into contact with the patient. No applied parts provided.			

4.7	RM RESULTS TABLE: Single Fault Condition for ME Equipment		N/E
Clause of ISO 14971	Document Ref. in RMF (Document No. & paragraph)	Result - Remarks	Verdict
4.2			
4.3			
4.4			
Supplementary Information: The risk management requirements of the standard were not addressed. All applicable single fault conditions performed according to the standard.			

4.8	RM RESULTS TABLE: Components of ME Equipment		N/E
Clause of ISO 14971	Document Ref. in RMF (Document No. & paragraph)	Result - Remarks	Verdict
4.2			
4.3			
4.4			

IEC 60601-1			
Clause	Requirement + Test	Result - Remark	Verdict
4.8	RM RESULTS TABLE: Components of ME Equipment		N/E
Clause of ISO 14971	Document Ref. in RMF (Document No. & paragraph)	Result - Remarks	Verdict
5			
6.2			
6.3			
6.4			
6.5			
Supplementary Information: IEC approved components provided within the unit. The risk management requirements of the standard were not addressed.			

4.9	RM RESULTS TABLE: Use of components with high-integrity characteristics		N/E
Clause of ISO 14971	Document Ref. in RMF (Document No. & paragraph)	Result - Remarks	Verdict
4.2			
4.3			
4.4			
5			
6.2			
6.3			
6.4			
6.5			
Supplementary Information: The risk management requirements of the standard were not addressed. Approved components provided between primary and secondary circuit. Refer to List of critical components.			

IEC 60601-1			
Clause	Requirement + Test	Result - Remark	Verdict

4.11	TABLE: Power Input					P
Operating Conditions / Ratings	Voltage (V)	Frequency (Hz)	Current (A)	Power (W)	Power factor (cos φ)	
Rated output load	264	50	0,61	149,0	--	
Rated output load	240	50	0,65	149,3	--	
Rated output load	216	50	0,71	149,3	--	
Rated output load	110	50	1,39	153,0	--	
Rated output load	100	50	1,55	154,0	--	
Rated output load	90	50	1,73	155,0	--	
Rated output load	264	60	0,61	149,0	--	
Rated output load	240	60	0,66	149,2	--	
Rated output load	216	60	0,71	149,5	--	
Rated output load	110	60	1,39	153,0	--	
Rated output load	100	60	1,54	154,0	--	
Rated output load	90	60	1,73	156,0	--	

Supplementary Information:
 Rated input voltage: 100-240 Vac
 Rated input current: 3,0-1,5 A
 See copy of marking plate for details.

5.1	RM RESULTS TABLE: Type Tests		N/A
Clause of ISO 14971	Document Ref. in RMF (Document No. & paragraph)	Result - Remarks	Verdict
4.2			
4.3			
4.4			

Supplementary Information: /

5.4 a)	RM RESULTS TABLE: Other Conditions		N/E
Clause of ISO 14971	Document Ref. in RMF (Document No. & paragraph)	Result - Remarks	Verdict
4.2			
4.3			

IEC 60601-1			
Clause	Requirement + Test	Result - Remark	Verdict
5.4 a)	RM RESULTS TABLE: Other Conditions		N/E
Clause of ISO 14971	Document Ref. in RMF (Document No. & paragraph)	Result - Remarks	Verdict
4.4			
Supplementary Information: Maximum ambient temperature: 55°C (specified by the manufacturer). The risk management requirements of the standard were not addressed.			

5.7	RM RESULTS TABLE: Humidity preconditioning treatment		N/A
Clause of ISO 14971	Document Ref. in RMF (Document No. & paragraph)	Result - Remarks	Verdict
4.2			
4.3			
4.4			
5			
6.2			
6.3			
6.4			
6.5			
Supplementary Information: Standard humidity treatment performed.			

5.9.2	TABLE: Determination of ACCESSIBLE parts		N/A
Location	Determination method (NOTE1)	Comments	
Supplementary information: NOTE 1 - The determination methods are: visual; rigid test finger; jointed test finger; test hook.			
Supplementary Information: Power supply unit is intended for building-in. End product consideration.			

5.9.2.3	RM RESULTS TABLE: Actuating mechanisms		N/A
Clause of ISO 14971	Document Ref. in RMF (Document No. & paragraph)	Result - Remarks	Verdict
4.2			
4.3			
4.4			
5			

IEC 60601-1			
Clause	Requirement + Test	Result - Remark	Verdict

5.9.2.3	RM RESULTS TABLE: Actuating mechanisms		N/A
Clause of ISO 14971	Document Ref. in RMF (Document No. & paragraph)	Result - Remarks	Verdict
6.2			
6.3			
6.4			
6.5			
Supplementary Information: No such parts provided.			

7.1.2	TABLE: Legibility of Marking		N/A
Markings tested	Ambient illuminance (lx)	Remarks	
Outside Markings (Clause 7.2)	--	--	
Inside Markings (Clause 7.3)	--	--	
Controls & Instruments (Clause 7.4).....	--	--	
Safety Signs (Clause 7.5)	--	--	
Symbols (Clause 7.6).....	--	--	
Supplementary information: Observer, with a visual acuity of 0 on the log Minimum Angle of Resolution (log MAR) scale or 6/6 (20/20), reads marking at ambient illuminance least favourable level in the range of 100 lx to 1,500 lx. The ME EQUIPMENT or its part was positioned so that the viewpoint was the intended position of the OPERATOR at any point within the base of a cone subtended by an angle of 30° to the axis normal to the centre of the plane of the marking and at a distance of 1 m.			
Supplementary Information: Power supply unit is intended for building-in. Marking provided on the outer side of the power supply unit shall not be visible after installation within the end medical product.			

7.1.3	TABLE: Durability of marking test		P
Characteristics of the Marking Label tested:		Remarks	
Material of Marking Label	In-print method	Pass	
Ink/other printing material or process.....	Laser printing	Pass	
Material (composition) of Warning Label		N/A	
Ink/other printing material or process.....		N/A	
Other		N/A	
Supplementary information: Marking rubbed by hand, first for 15 s with a cloth rag soaked with distilled water, then for 15 s with a cloth rag soaked with methylated spirit, and then for 15 s with a cloth rag soaked with isopropyl alcohol.			

7.2.2	RM RESULTS TABLE: Identification	N/A
-------	----------------------------------	-----

IEC 60601-1			
Clause	Requirement + Test	Result - Remark	Verdict
Clause of ISO 14971	Document Ref. in RMF (Document No. & paragraph)	Result - Remarks	Verdict
4.2			
4.3			
4.4			
5			
6.4			
Supplementary Information: /			

7.2.5	RM RESULTS TABLE: ME EQUIPMENT powered from other equipment		N/A
Clause of ISO 14971	Document Ref. in RMF (Document No. & paragraph)	Result - Remarks	Verdict
4.2			
4.3			
4.4			
5			
6.4			
Supplementary Information: EUT is intended for connection to the mains.			

7.2.13	RM RESULTS TABLE: Physiological effects (safety signs and warning)		N/A
Clause of ISO 14971	Document Ref. in RMF (Document No. & paragraph)	Result - Remarks	Verdict
4.2			
4.3			
4.4			
5			
6.3			
Supplementary Information: /			

7.2.17	RM RESULTS TABLE: Protective packaging		N/A
Clause of ISO 14971	Document Ref. in RMF (Document No. & paragraph)	Result - Remarks	Verdict
4.2			
4.3			
4.4			
5			

IEC 60601-1			
Clause	Requirement + Test	Result - Remark	Verdict
7.2.17	RM RESULTS TABLE: Protective packaging		N/A
Clause of ISO 14971	Document Ref. in RMF (Document No. & paragraph)	Result - Remarks	Verdict
6.3			
6.4			
Supplementary Information: Power supply unit is part of the investigation. Protective packaging not safety relevant.			

7.3.3	RM RESULTS TABLE: Batteries		N/A
Clause of ISO 14971	Document Ref. in RMF (Document No. & paragraph)	Result - Remarks	Verdict
4.2			
4.3			
4.4			
5			
6.3			
Supplementary Information: No batteries inside. Mains operated equipment.			

7.3.7	RM RESULTS TABLE: Supply terminals		N/A
Clause of ISO 14971	Document Ref. in RMF (Document No. & paragraph)	Result - Remarks	Verdict
4.3			
Supplementary Information: Approved appliance inlet used for mains supply.			

7.4.2	RM RESULTS TABLE: Control devices		N/A
Clause of ISO 14971	Document Ref. in RMF (Document No. & paragraph)	Result - Remarks	Verdict
4.2			
4.3			
4.4			
5			
6.2			
6.3			
Supplementary Information: No control devices provided.			

IEC 60601-1			
Clause	Requirement + Test	Result - Remark	Verdict

7.5	RM RESULTS TABLE: Safety signs		N/A
Clause of ISO 14971	Document Ref. in RMF (Document No. & paragraph)	Result - Remarks	Verdict
4.2			
4.3			
4.4			
5			
6.3			
Supplementary Information: No safety signs in a manner of this clause provided.			

7.9.1	RM RESULTS TABLE: General accompanying documents (See Table C.4)		N/A
Clause of ISO 14971	Document Ref. in RMF (Document No. & paragraph)	Result - Remarks	Verdict
4.2			
4.3			
4.4			
5			
6.2			
6.3			
Supplementary Information: Paper version of accompanying document provided by manufacturer.			

7.9.2.4	RM RESULTS TABLE: Electrical power source		N/A
Clause of ISO 14971	Document Ref. in RMF (Document No. & paragraph)	Result - Remarks	Verdict
4.2			
4.3			
4.4			
5			
6.3			
Supplementary Information: No additional power source incorporated. EUT is intended for connection to the mains.			

7.9.3.2	RM RESULTS TABLE: Replacement of fuses, power supply cords, other parts		N/A
Clause of ISO 14971	Document Ref. in RMF (Document No. & paragraph)	Result - Remarks	Verdict

IEC 60601-1			
Clause	Requirement + Test	Result - Remark	Verdict
7.9.3.2	RM RESULTS TABLE: Replacement of fuses, power supply cords, other parts		N/A
Clause of ISO 14971	Document Ref. in RMF (Document No. & paragraph)	Result - Remarks	Verdict
4.2			
4.3			
4.4			
5			
6.2			
6.3			
6.4			
6.5			
Supplementary Information: EUT is not permanently installed equipment.			

8.1 b(1)	RM RESULTS TABLE: Fundamental rule of protection against electric shock - interruption of any one power-carrying conductor		N/A
Clause of ISO 14971	Document Ref. in RMF (Document No. & paragraph)	Result - Remarks	Verdict
4.3			
4.4			
Supplementary Information: No conductor between ME equipment parts and separate enclosures.			

8.1 b(2)	RM RESULTS TABLE: Fundamental rule of protection against electric shock - unintended movement of a component		N/A
Clause of ISO 14971	Document Ref. in RMF (Document No. & paragraph)	Result - Remarks	Verdict
4.2			
4.3			
4.4			
5			
6.2			
6.3			
6.4			
6.5			
Supplementary Information: All internal components are mounted securely to prevent excessive bending (Reduction of creepage and clearance distances prevented by design).			

IEC 60601-1			
Clause	Requirement + Test	Result - Remark	Verdict

8.1 b(3)	RM RESULTS TABLE: Fundamental rule of protection against electric shock - accidental detachment of conductors and connectors		N/A
Clause of ISO 14971	Document Ref. in RMF (Document No. & paragraph)	Result - Remarks	Verdict
4.3			
Supplementary Information: No conductors used in power supply. For connection to the input and outputs approved wiring terminals are used. See list of critical components.			

8.2.2	RM RESULTS TABLE: Connection to an external d.c. power sources		N/A
Clause of ISO 14971	Document Ref. in RMF (Document No. & paragraph)	Result - Remarks	Verdict
4.2			
4.3			
4.4			
5			
Supplementary Information: Mains operated equipment.			

8.3 d	RM RESULTS TABLE: Requirements of Type BF or CF Applied Parts		N/A
Clause of ISO 14971	Document Ref. in RMF (Document No. & paragraph)	Result - Remarks	Verdict
6.2		See also RM Table for 4.6	
Supplementary Information: No applied parts provided.			

8.4.2	TABLE: TABLE: Working Voltage / Power Measurement					P
Test supply voltage/frequency (V/Hz) ¹						240 Vac / 50 Hz
Location From/To	Measured values					Remarks
	Vrms	Vpk or Vdc	Peak-to-peak ripple ²	Power W/VA	Energy (J)	
Model: GTM91092-110-M (DC1 overload)						
Measured between output plus and COM	--	4,95	--	29,26VA	--	Maximum output current achieved: 6,75 A
Model: GTM91092-110-M (input current limitation disabled R3,R303 short)						

IEC 60601-1						
Clause	Requirement + Test				Result - Remark	Verdict
8.4.2	TABLE: TABLE: Working Voltage / Power Measurement					P
Measured between output plus and COM	--	4,95	--	48,75 VA	--	Maximum output current achieved: 12,5 A
Model: GTM91092-110-M (DC2 overload)						
Measured between output plus and COM	--	4,97	--	21,45 VA	--	Maximum output current achieved: 5,5 A
Model: GTM91092-110-M (DC 2 input current limitation disabled R3,R303 short)						
Measured between output plus and COM	--	4,97	--	21,45 VA	--	Maximum output current achieved: 5,2 A
Model: GTM91092-110-M (DC3 overload)						
Measured between output plus and COM	--	5,35	--	9,32 VA	--	Maximum output current achieved: 1,9 A
Model: GTM91092-110-M (DC 3 input current limitation disabled R3,R303 short)						
Measured between output plus and COM	--	5,35	--	9,32 VA	--	Maximum output current achieved: 2,4 A
Model: GTM91092-110-M (DC4 overload)						
Measured between output plus and COM	--	130,2	--	28,90 VA	--	Maximum output current achieved: 1,2 A
Model: GTM91092-110-M (DC 4 input current limitation disabled R3,R303 short)						
Measured between output plus and COM	--	130,2	--	25,7 VA	--	Maximum output current achieved: 1,2 A
Model: GTM91092-110-M (DC5 overload)						
Measured between output plus and COM	--	13,5	--	60,81 VA	--	Maximum output current achieved: 4,9 A
Model: GTM91092-110-M (DC 5 input current limitation disabled R3,R303 short)						
Measured between output plus and COM	--	13,5	--	53,3 VA	--	Maximum output current achieved: 4,1 A

IEC 60601-1			
Clause	Requirement + Test	Result - Remark	Verdict

8.4.2	TABLE: TABLE: Working Voltage / Power Measurement		P
-------	---	--	---

Supplementary Information:

1. The input supply voltage to the ME EQUIPMENT shall be the RATED voltage or the voltage within the RATED voltage range which results in the highest measured value. See clause 8.5.4.
 2. If the d.c peak-to-peak ripple >10%, waveform considered as a.c. See clause 8.4.2.2

Supplementary Information:

Equipment provides five outputs.

Those outputs shall not be accessible by the user and are only used for supplying end medical product by its output voltages.

Measurements performed only for reference.

For output voltage and current during single fault conditions see table 13.2: TABLE: single fault conditions in accordance with 13.2.2 to 13.2.13, inclusive.

8.4.2 c	RM RESULTS TABLE: Accessible parts including applied parts		N/A
---------	--	--	-----

Clause of ISO 14971	Document Ref. in RMF (Document No. & paragraph)	Result - Remarks	Verdict
4.2			
4.3			
4.4			

Supplementary Information:

Power supply unit is intended for building-in. End product consideration.

8.4.3	TABLE: ME EQUIPMENT for connection to a power source by a plug - measurement of voltage or calculation of stored charge 1 s after disconnection of plug from mains supply		P
-------	---	--	---

Maximum allowable voltage (V) : 60

Voltage measured (V)

Voltage Measured Between:	1	2	3	4	5	6	7	8	9	10
Plug pins 1 and 2	4	3	--	--	--	--	--	--	--	--
Plug pin 1 and plug earth pin	--	--	--	--	--	--	--	--	--	--
Plug pin 2 and plug earth pin	--	--	--	--	--	--	--	--	--	--
Plug pin 1 and enclosure	--	--	--	--	--	--	--	--	--	--
Plug pin 2 and enclosure	--	--	--	--	--	--	--	--	--	--

Maximum allowable stored charge when measured voltage exceeded 60 v (µc) : 45

Calculated stored charge (µc)

Voltage Measured Between:	1	2	3	4	5	6	7	8	9	10
Plug pins 1 and 2	--	--	--	--	--	--	--	--	--	--

IEC 60601-1											
Clause	Requirement + Test	Result - Remark						Verdict			

Plug pin 1 and plug earth pin	--	--	--	--	--	--	--	--	--	--
Plug pin 2 and plug earth pin	--	--	--	--	--	--	--	--	--	--
Plug pin 1 and enclosure	--	--	--	--	--	--	--	--	--	--
Plug pin 2 and enclosure	--	--	--	--	--	--	--	--	--	--

Supplementary information:
 Discharge performed at peak supply voltage; therefore performed only 2 times (upper peak, lower peak).
 Supply voltage: 264V; 50Hz
 See scope picture below.

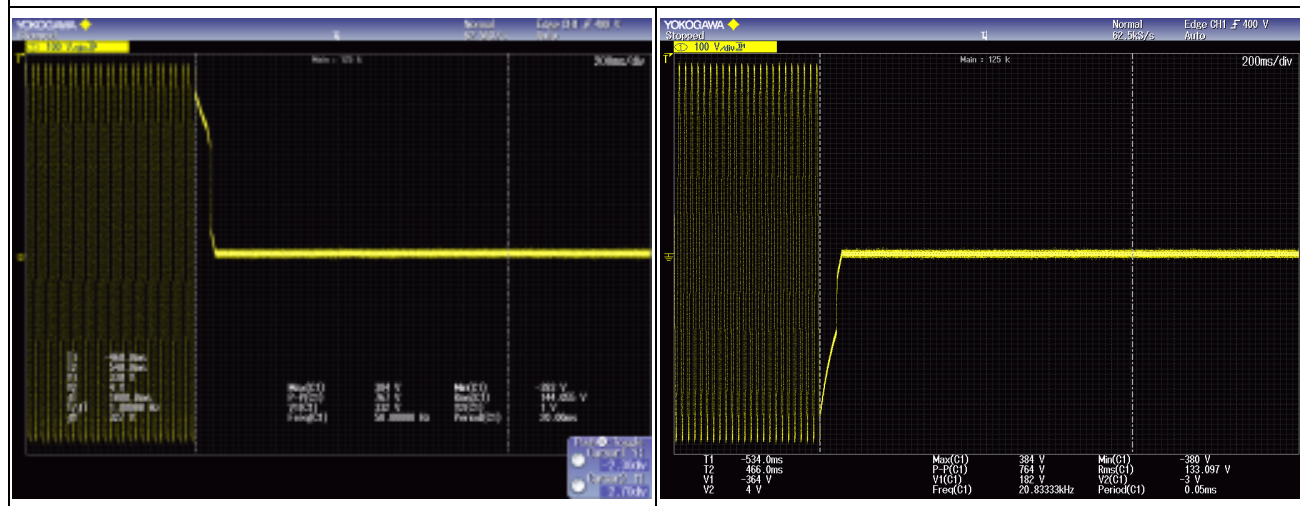

8.4.4	TABLE: Internal capacitive circuits – measurement of residual voltage or calculation of the stored charge in capacitive circuits (i.e., accessible capacitors or circuit parts) after de-energizing ME EQUIPMENT	N/A
--------------	---	------------

Maximum allowable residual voltage (V):	60 V
---	-------------

Maximum allowable stored charge when residual voltage exceeded 60 V :	45 μC
---	--------------

Description of the capacitive circuit (i.e., accessible capacitor or circuit parts)	Measured residual voltage (V)	Calculated stored charge (μC)	Remarks

Supplementary information: /

8.5.2.2	RM RESULTS TABLE: Type B applied parts	N/A
----------------	---	------------

Clause of ISO 14971	Document Ref. in RMF (Document No. & paragraph)	Result - Remarks	Verdict
4.2			
4.3			
4.4			

IEC 60601-1			
Clause	Requirement + Test	Result - Remark	Verdict
8.5.2.2	RM RESULTS TABLE: Type B applied parts		N/A
Clause of ISO 14971	Document Ref. in RMF (Document No. & paragraph)	Result - Remarks	Verdict
5			
Supplementary information: No applied parts provided.			

8.5.2.3	RM RESULTS TABLE: PATIENT Leads		N/A
Clause of ISO 14971	Document Ref. in RMF (Document No. & paragraph)	Result - Remarks	Verdict
4.2			
4.3			
4.4			
5			
Supplementary information: No patient leads provided.			

8.5.5.1a	TABLE: defibrillation-proof applied parts – measurement of hazardous electrical energies				N/A
Test Condition: Figs. 9 & 10	Measurement made on accessible part	Applied part with test voltage	Test voltage polarity	Measured voltage between Y1 and Y2 (mV)	Remarks
Supplementary information: No applied parts provided.					

8.5.5.1b	TABLE: defibrillation-proof applied parts – verification of recovery time				N/A
Applied part with test voltage	Test voltage polarity	Recovery time from documents (s)	Measured recovery time (s)	Remarks	
Supplementary information: No applied parts provided.					

8.5.5.2	TABLE: DEFIBRILLATION-PROOF APPLIED PARTS OR PATIENT CONNECTIONS of DEFIBRILLATION-PROOF APPLIED PARTS - Energy reduction test –measurement of Energy delivered to a 100 Ω load			N/A
Test Voltage applied to	Measured Energy E1 (mJ)	Measured Energy E2 (mJ)	Energy E1 as % of E2 (%)	

IEC 60601-1			
Clause	Requirement + Test	Result - Remark	Verdict
	PATIENT CONNECTION 1 or APPLIED PART with PATIENT CONNECTIONS 2, 3, and 4 of the same APPLIED PART connected to earth		
	PATIENT CONNECTION 2 or APPLIED PART with PATIENT CONNECTIONS 1, 3, and 4 of the same APPLIED PART connected to earth		
	PATIENT CONNECTION 3 or APPLIED PART with PATIENT CONNECTIONS 1, 2, and 4 of the same APPLIED PART connected to earth		
	PATIENT CONNECTION 4 or APPLIED PART with PATIENT CONNECTIONS 1, 2, and 3 of the same APPLIED PART connected to earth		
Supplementary information: For compliance: E1 must at least 90% of E2 E1= Measured energy delivered to 100 Ω with ME Equipment connected; E2= Measured energy delivered to 100 Ω without ME equipment connected.			

8.6.3	RM RESULTS TABLE: Protective earthing of moving parts		N/A
Clause of ISO 14971	Document Ref. in RMF (Document No. & paragraph)	Result - Remarks	Verdict
4.2			
4.3			
4.4			
5			
6.2			
6.3			
6.4			
6.5			
Supplementary information: No moving parts.			

IEC 60601-1			
Clause	Requirement + Test	Result - Remark	Verdict

8.6.4	TABLE: Impedance and current-carrying capability of PROTECTIVE EARTH CONNECTIONS Class I equipment. Protective earthing provided.			P
Type of ME EQUIPMENT & impedance measured between parts	Test current (A) /Duration (s)	Voltage drop measured between parts (V)	Maximum calculated impedance (mΩ)	Maximum allowable impedance (mΩ)
PERMANENTLY INSTALLED ME EQUIPMENT, impedance between PROTECTIVE EARTH TERMINAL and a PROTECTIVELY EARTHED part	--	--	--	100
ME EQUIPMENT with an APPLIANCE INLET, impedance between earth pin in the APPLIANCE INLET and a PROTECTIVELY EARTHED part (see locations below)	See below.	See Below	See below	100
Right side of the metal enclosure	24,5	0,58	0,024	100
Left side of the metal enclosure	24,3	0,58	0,024	100
Back side of the metal enclosure	24,7	0,67	0,027	100
Top side of the metal enclosure	24,6	0,84	0,034	100
Bottom side of the metal enclosure	24,6	0,67	0,027	100
Right side of the metal enclosure	26,0	0,53	0,020	100
Left side of the metal enclosure	25,9	0,66	0,025	100
Back side of the metal enclosure	26,0	0,51	0,020	100
Top side of the metal enclosure	26,0	0,64	0,025	100
Bottom side of the metal enclosure	26,0	0,50	0,019	100
Right side of the metal enclosure	41,4	0,89	0,021	100
Left side of the metal enclosure	41,4	0,99	0,024	100
Back side of the metal enclosure	41,3	0,92	0,022	100
Top side of the metal enclosure	41,3	1,11	0,027	100
Bottom side of the metal enclosure	41,3	0,88	0,021	100
Potential equalization terminal	24,8	0,48	0,019	100
Potential equalization terminal	40,9	0,78	0,019	100
ME EQUIPMENT with a non-DETACHABLE POWER SUPPLY CORD, impedance between the protective earth pin in the MAINS PLUG and a PROTECTIVELY EARTHED part	--	--	--	200
POWER SUPPLY FOR BUILDING IN - ME EQUIPMENT, impedance between PROTECTIVE EARTH TERMINAL and a PROTECTIVELY EARTHED part				
Supplementary information:				
Power supply unit intended for building-in. Test performed only for reference and shall be repeated after installation of the power supply unit within the end medical product.				

IEC 60601-1				
Clause	Requirement + Test	Result - Remark		Verdict
8.7	TABLE: leakage current			P
Type of leakage current and test condition (including single faults)	Supply voltage (V)	Supply frequency (Hz)	Measured max. value (µA)	Remarks
Fig. 13 - Earth Leakage (ER)	—	—	—	Maximum allowed values: 5 mA NC; 10 mA SFC
Earth leakage current, before humidity treatment, normal polarity, normal condition	264 V~	60 Hz	218	Within the limit of the standard.
Earth leakage current, before humidity treatment, reverse polarity, normal condition	264 V~	60 Hz	221	Within the limit of the standard.
Earth leakage current, before humidity treatment, normal polarity, single fault condition	264 V~	60 Hz	413	Within the limit of the standard.
Earth leakage current, before humidity treatment, reverse polarity, single fault condition	264 V~	60 Hz	414	Within the limit of the standard.
Earth leakage current, after humidity treatment, normal polarity, normal condition	264 V~	60 Hz	231	Within the limit of the standard.
Earth leakage current, after humidity treatment, reverse polarity, normal condition	264 V~	60 Hz	233	Within the limit of the standard.
Earth leakage current, after humidity treatment, normal polarity, single fault condition	264 V~	60 Hz	432	Within the limit of the standard.
Earth leakage current, after humidity treatment, reverse polarity, single fault condition	264 V~	60 Hz	431	Within the limit of the standard.
Fig. 14 - Touch Current (TC)	—	—	—	Maximum allowed values: 100 µA NC; 500 µA SFC
Fig. 15 - Patient Leakage Current (P)	—	—	—	Maximum allowed values: Type B or BF AP: 10 µA NC; 50 µA SFC (d.c. current); 100 µA NC; 500 µA SFC (a.c.) Type CF AP: 10 µA NC; 50 µA SFC (d.c. or a.c. current)
Fig. 16 - Patient leakage current with mains on the F-type applied parts (PM)	—	—	—	Maximum allowed values: Type B: N/A Type BF AP: 5000 µA Type CF AP: 50 µA

IEC 60601-1				
Clause	Requirement + Test		Result - Remark	Verdict
Fig. 17 - Patient leakage current with external voltage on Signal Input/Output part (SIP/SOP)	—	—	—	Maximum allowed values: Type B or BF AP: 10 uA NC; 50 uA SFC(d.c. current); 100 uA NC; 500 uA SFC (a.c.) ; Type CF AP: 10 uA NC; 50 uA SFC (d.c. or a.c. current)
Fig. 18 - Patient leakage current with external voltage on metal Accessible Part that is not Protectively Earthed	—	—	—	Maximum allowed values: Type B or BF AP: 500 uA Type CF: N/A
Fig. 19 – Patient Auxiliary Current	—	—	—	Maximum allowed values: Type B or BF AP: 10 uA NC; 50 uA SFC (d.c. current); 100 uA NC; 500 uA SFC (a.c.) ; Type CF AP: 10 uA NC;50 uA SFC (d.c. or a.c. current)
Fig. 15 and 20 – Total Patient Leakage Current with all AP of same type connected together	—	—	—	Maximum allowed values: Type B or BF AP: 50 uA NC; 100uA SFC (d.c. current); 500 uA NC; 1000 uA SFC (a.c.); Type CF AP: 50 uA NC; 100 uA SFC (d.c. or a.c. current)
Fig. 17 and 20 – Total Patient Leakage Current with all AP of same type connected together with external voltage on SIP/SOP	—	—	—	Maximum allowed values: Type B or BF AP: 50 uA NC; 100uA SFC (d.c. current); 500 uA NC;1000 uA SFC (a.c.); Type CF AP: 50 uA NC; 100 uA SFC (d.c. or a.c. current)
Fig. 16 and 20 – Total Patient Leakage Current with all AP of same type connected together with external voltage on F-type AP	—	—	—	Maximum allowed values: Type B: NA Type BF: 5000uA Type CF: 100 uA
Fig. 18 and 20 – Total Patient Leakage Current with all AP of same type connected together with external voltage on metal Accessible Part not Protectively Earthed	—	—	—	Maximum allowed values: Type B & BF: 1000 uA Type CF: N/A

IEC 60601-1			
Clause	Requirement + Test	Result - Remark	Verdict

Note 1: For EARTH LEAKAGE CURRENT see 8.7.3 d) and 8.7.4.5;
Note 2: For TOUCH CURRENT see 8.7.3 c) and 8.7.4.6;
Note 3: For PATIENT LEAKAGE CURRENT SEE 8.7.3.b) and 8.7.4.7
Note 4: Total PATIENT LEAKAGE CURRENT values are only relative to equipment with multiple APPLIED PARTS of the same type. See 8.7.4.7 h). The individual APPLIED PARTS complied with the PATIENT LEAKAGE CURRENT values.
Note 5: In addition to conditions indicated in the Table, tests conducted at operating temperature and after humidity preconditioning of 5.7, EQUIPMENT energized in stand-by condition and fully operating, max rated supply frequency, at 110 % of the max RATED MAINS VOLTAGE, and after relevant tests of Clause 11.6 (i.e., overflow, spillage, leakage, ingress of water and particulate matter, cleaning & disinfection, & sterilization).

ER - Earth leakage current TC – Touch current P - Patient leakage current PA – Patient auxiliary current TP – Total Patient current PM - Patient leakage current with mains on the applied parts MD - Measuring device	A - After humidity conditioning B - Before humidity conditioning 1 - Switch closed or set to normal polarity 0 - Switch open or set to reversed polarity NC - Normal condition SFC - Single fault condition
--	--

Supplementary information:
 Two capacitors C310 & C311 (Y2 type) in series connected between primary and secondary circuit.
 Equipment under test is provided with metal enclosure, which is connected to protective earth terminal.
 Output connector provided on the top side of the enclosure is not intended for contact with the user (it should not be accessible when installed inside the end medical product). Output connector is intended for supplying end medical product by its output voltages and is not intended for other application.
 Leakage current measurements were performed only for reference because the equipment under test is switch mode power supply unit intended for building in. To be evaluated during end medical product approval.

8.8.3	TABLE: Dielectric strength test of solid insulating materials with safety function – MEANS OF OPERATOR PROTECTION (MOOP) / MEANS OF PATIENT PROTECTION (MOPP)				P
Insulation under test (area from insulation diagram)	Insulation Type (1 or 2 MOOP/MOPP)	Reference Voltage		A.C. test voltages in V r.m.s ¹	Dielectric breakdown after 1 minute Yes/No ²
		PEAK WORKING VOLTAGE (U) V _{peak}	PEAK WORKING VOLTAGE (U) V d.c.		
Basic insulation:					
Area A (Primary to PE)	1xMOOP	591 V _{peak}	--	1893 Vac*	No
Reinforced insulation:					
Area B (primary to secondary)	2xMOOP	600 V _{peak}	--	3000 Vac	No
Area B (primary to secondary transformer T2)	2xMOOP	600 V _{peak}	--	3000 Vac	No

IEC 60601-1			
Clause	Requirement + Test	Result - Remark	Verdict

¹ Alternatively, per the Table (i.e., __dc), a d.c. test voltage equal to the peak value of the a.c. test voltage used.
² A) Immediately after humidity treatment of 5.7, ME EQUIPMENT de-energized, B) after required sterilization PROCEDURE, ME EQUIPMENT de-energized, C) after reaching steady state operating temperature as during heating test of 11.1.1, and D) after relevant tests of 11.6 (i.e., overflow, spillage, leakage, ingress of water, cleaning, disinfection, and sterilization).

Supplementary information:
EUT was evaluated for 2 Means Of Operator Protection (2 x MOOP) between primary and secondary. Dielectric strength test between primary and secondary side of the unit was performed when PCB was removed from the metal enclosure.
***Based on measured working voltage between Transformer T2 and PE.**

8.8.4.1	TABLE: Resistance to heat - Ball pressure test of thermoplastic parts		N/A
	Allowed impression diameter (mm)	≤ 2 mm	—
	Force (N)	20	—
Part/material		Test temperature (°C)	Impression diameter (mm)

Supplementary information:
Manufacturer is using approved materials with adequate temperature characteristics. See Table 8.10. No additional test was considered required.

8.8.4.1	RM RESULTS TABLE: Mechanical strength and resistance to heat		N/E
Clause of ISO 14971	Document Ref. in RMF (Document No. & paragraph)	Result - Remarks	Verdict
4.2			
4.3			
4.4			
5			
6.2			
6.3			
6.4			
6.5			

Supplementary information:
The risk management requirements of the standard were not addressed.

8.9.2	TABLE: Short circuiting of each single one of the CREEPAGE DISTANCES and AIR CLEARANCES for insulation in the MAINS PART between parts of opposite polarity in lieu of complying with the required measurements in 8.9.4	N/A
-------	--	-----

IEC 60601-1				
Clause	Requirement + Test	Result - Remark	Verdict	
	Specific areas of circuits short-circuited and test conditions	Test in lieu of CREEPAGE DISTANCE or AIR CLEARANCE¹	HAZARDOUS SITUATION observed (i.e., fire hazard, shock hazard, explosion, discharge of parts, etc.)? Yes/No	Remarks
Supplementary information: Note 1: AC - AIR CLEARANCE CD - CREEPAGE DISTANCE				
Supplementary information: Sufficient creepage and clearance distances between parts of opposite polarity provided before mains fuses. After mains fuses, distances verified by short circuit. See Table 13.2 for details.				

IEC 60601-1			
Clause	Requirement + Test	Result - Remark	Verdict

8.9.3.2	Table: Thermal cycling tests on one sample of insulating compound forming solid insulation between conductive parts		N/A
Test Sequence No.	Each test duration and temperature	Dielectric test voltage (V = Test voltage in 8.8.3 times 1.6)	Dielectric strength test after humidity preconditioning per cl. 5.7 except for 48 h only, Breakdown: Yes/No
1	68 h at T1 ± 2 °C = ___ °C ¹		
	1 h at 25 °C ± 2 °C		
	2 h at 0 °C ± 2 °C		
	1 or more h at 25 °C ± 2 °C		
2	68 h at T1 ± 2 °C = ___ °C ¹		
	1 h at 25 °C ± 2 °C		
	2 h at 0 °C ± 2 °C		
	1 or more h at 25 °C ± 2 °C		
3	68 h at T1 ± 2 °C = ___ °C ¹		
	1 h at 25 °C ± 2 °C		
	2 h at 0 °C ± 2 °C		
	1 or more h at 25 °C ± 2 °C		
4	68 h at T1 ± 2 °C = ___ °C ¹		
	1 h at 25 °C ± 2 °C		
	2 h at 0 °C ± 2 °C		
	1 or more h at 25 °C ± 2 °C		

Supplementary information:

¹ T1 = 10 °C above the maximum temperature of relevant part determined per 11.1.1, or 85 °C, the higher of the two. 10 °C not added to T1 when temperature measured by an embedded thermocouple. Used gradual transition from one temperature to another.

IEC 60601-1			
Clause	Requirement + Test	Result - Remark	Verdict

8.9.3.4	Table: Thermal cycling tests on one sample of cemented joint (see 8.9.3.3)		N/A
Test Sequence No.	Each test duration and temperature	Dielectric test voltage (V = Test voltage in 8.8.3 times 1.6)	Dielectric strength test after humidity preconditioning per cl. 5.7 except for 48 h only, Breakdown: Yes/No
1	68 h at T1 ± 2 °C = ___ °C ¹		
	1 h at 25 °C ± 2 °C		
	2 h at 0 °C ± 2 °C		
	1 or more h at 25 °C ± 2 °C		
2	68 h at T1 ± 2 °C = ___ °C ¹		
	1 h at 25 °C ± 2 °C		
	2 h at 0 °C ± 2 °C		
	1 or more h at 25 °C ± 2 °C		
3	68 h at T1 ± 2 °C = ___ °C ¹		
	1 h at 25 °C ± 2 °C		
	2 h at 0 °C ± 2 °C		
	1 or more h at 25 °C ± 2 °C		
4	68 h at T1 ± 2 °C = ___ °C ¹		
	1 h at 25 °C ± 2 °C		
	2 h at 0 °C ± 2 °C		
	1 or more h at 25 °C ± 2 °C		

Supplementary information:

¹ T1 = 10 °C above the maximum temperature of relevant part determined per 11.1.1, or 85 °C, the higher of the two. 10 °C not added to T1 when temperature measured by an embedded thermocouple. Used gradual transition from one temperature to another.

IEC 60601-1			
Clause	Requirement + Test	Result - Remark	Verdict

8.10	TABLE: List of critical components					P
Component/ Part No.	Manufacturer/ Trademark	Type No./model No./	Technical data	Standard No./, Edition	Mark(s) & Certificates of conformity 1	
Enclosure	Aluminium, overall 280,5 by 223 by 223 mm Min. 1,0 mm thick Provided with openings 8,0 mm by 8,0 mm on left/front side of the enclosure (40 openings) and on the back side of the enclosure (35 openings) and with openings 8,0 mm by 2,9 mm (9 openings).			--	--	
Appliance inlet (CN5)	BULGIN ELEKTRON TECHNOLOGY UK LIMITED	PF0030/28 PF0030/48	10 A, 250 V with 2 built-in 5x20 mm fuse holders	IEC60320-1 (AYVZ2)	VDE, SEMKO UL E92187	
Appliance inlet (CN5) (alternative)	INTERPOWER Corp.	83110170	10 A, 250 V with 2 built-in 5x20 mm fuse holders	IEC60320-1 (AYVZ2)	VDE, SEMKO UL E104234	
Appliance inlet (CN5) (alternative)	STEADY ELECTRONICS CORP	2107	10 A, 250 V with 2 built-in 5x20 mm fuse holders	IEC60320-1 (AYVZ2)	VDE 40011923 UL E315002	
Appliance inlet (CN5) (alternative)	SCHURTER	KEA (Screw-On type)	10 A, 250 V with 2 built-in 5x20 mm fuse holders	IEC60320-1 (AYVZ2)	VDE 40030338 SEMKO UL E93617 CSA	
Appliance inlet (CN5) (alternative)	Various	Various (Screw-On type)	10 A, 250 V with 2 built-in 5x20 mm fuse holders	IEC60320-1 (AYVZ2)	VDE or equivalent UL approved	
Input fuse (F1, F2)	LITTELFUSE	215004P	5x20mm, T4A 250V High breaking capacity	IEC 60127-2/5 (JDYX2)	VDE 40013521 UL E10480	
Input fuse (F1, F2) (alternative)	BUSSMANN	S506 series S505 series	5x20mm, T4A 250V High breaking capacity	IEC 60127-2/5 (JDYX2)	VDE 40007864 VDE 40007860 UL E19180	
Input fuse (F1, F2) (alternative)	BELFUSE	5HT, 5HT-R, 5HTP, 5HTP-R	5x20mm, T4A 250V High breaking capacity	IEC 60127-2/5 (JDYX2)	VDE 40000505 UL E20624	
Input fuse (F1, F2) (alternative)	CONQUER	UDA	5.2x20mm, T4A 250V High breaking capacity	IEC 60127-2/5 (JDYX2)	VDE 40008022 UL E82636	

IEC 60601-1					
Clause	Requirement + Test			Result - Remark	Verdict
Input fuse (F1, F2) (alternative)	WALTER	TSC	5.2x20mm, T4A 250V High breaking capacity	IEC 60127-2/5 (JDYX2)	VDE 40016670 UL E56092
Input fuse (F1, F2) (alternative)	LITTELFUSE	477P	5x20mm, T4A 250V, High breaking capacity	IEC 60127-2/5 (JDYX2)	VDE 40025413 SEMKO 806815 UL E10480
Y-capacitor (C50, C52, C44, C45)	+ WALSIN	AC, AH	Min.250 Vac 470 pFmax. Min. Class Y2	IEC384-14/2 (FOWX2)	VDE 40001829 VDE 40001804 SEMKO UL E146544
Y-capacitor (C50, C52, C44, C45) (alternative)	JYA-NAY Co., Ltd.	JN	Min.250 Vac 470 pFmax. Min. Class Y2	IEC384-14/2 (FOWX2)	VDE 40001831 FIMKO UL E201384
Y-capacitor (C50, C52, C44, C45) (alternative)	MURATA	KH	Min.250 Vac 470 pFmax. Min. Class Y2	IEC384-14/2 (FOWX2)	VDE 40002796 SEMKO; DEMKO; FIMKO UL E37921
Y-capacitor (C50, C52, C44, C45) (alternative)	TDK	CS, CD	Min.250 Vac 470 pFmax. Min. Class Y2	IEC384-14/2 (FOWX2)	VDE 122006 DEMKO, FIMKO, SEMKO UL E37861
Y-capacitor (C50, C52, C44, C45) (alternative)	SUCCESS	SF, SB, SE	Min.250 Vac 470 pFmax. Min. Class Y2	IEC384-14/2 (FOWX2)	VDE 089780 VDE 094680 VDE 118218 SEMKO UL E114280
Y-capacitor (C50, C52, C44, C45) (alternative)	WELSON	KL	Min.250 Vac 470 pFmax. Min. Class Y2	IEC384-14/2 (FOWX2)	VDE 116772 FIMKO UL E104572
X-capacitor (C21)	+ULTRA TECH XIPHI ENTERPRISE Co. Ltd.	HQX	Min.250 Vac 1 µFmax. Min. Class X2	IEC384-14/2 (FOWX2)	VDE 40015608 UL E183780
X-capacitor (C21) (alternative)	KEMET ELECTRONICS ITALIA SRL	MKP	Min.250 Vac 1 µFmax. Min. Class X2	IEC384-14 UL1414 (FOWX2)	VDE 40012958 DEMKO; SEMKO; FIMKO UL E97797
X-capacitor (C21) (alternative)	OKAYA	RE-L series	Min.250 Vac 1 µFmax. Min. Class X2	IEC384-14 UL1414 (FOWX2)	VDE 40028657 SEMKO; DEMKO; FIMKO UL E47474,

IEC 60601-1					
Clause	Requirement + Test			Result - Remark	Verdict
X-capacitor (C21) (alternative)	DAIN ELECTRONICS Co. Ltd.	MPX	Min.250 Vac 1 μ Fmax. Min. Class X2	IEC384-14 (FOWX2)	VDE 40018798 FIMKO UL E147776,
X-capacitor (C43)	+ULTRA TECH XIPHI ENTERPRISE Co. Ltd.	HQX	Min.250 Vac 0,47 μ Fmax. Min. Class X2	IEC384-14/2 (FOWX2)	VDE 40024534 FIMKO UL E183780
X-capacitor (C43) (alternative)	KEMET ELECTRONICS ITALIA SRL	MKP	Min.250 Vac 0,47 μ Fmax. Min. Class X2	IEC384-14 (FOWX2)	VDE40012958 DEMKO; SEMKO; FIMKO UL E97797
X-capacitor (C43) (alternative)	OKAYA	RE-L series	Min.250 Vac 0,47 μ Fmax. Min. Class X2	IEC384-14 (FOWX2)	VDE, SEMKO; DEMKO; FIMKO UL E47474
X-capacitor (C43) (alternative)	DAIN ELECTRONICS Co. Ltd.	MPX	Min. 250 Vac 0,47 μ Fmax. Min. Class X2	IEC384-1 (FOWX2)	VDE 40018798; FIMKO UL E147776,
Inductor L2, L3	Open type construction. Magnet wire wound around toroidal core. Core: 18 mm by 10 by 10mm, 20 mH, Class B Insulation tape wound around the windings over the metal shield.			IEC 60601-1	Accepted
Varistor VAR1	+CENTRA SCIENCE Corp.	CNR-07D471K CNR-10D471K CNR-14D471K	300 Vac max.	IEC/EN 61051-2 UL1449 (VZCA2)	VDE 40008220 UL E316325
Varistor VAR1 (alternative)	PANASONIC	10K471U 14K471U	300 Vac max.	IEC/EN 61051-2 UL1449 (VZCA2)	VDE 40018677 UL E321499
Varistor VAR1 (alternative)	THINKING ELECTRONICS	TVR07471 TVR10471 TVR14471	300 Vac max.	IEC/EN 61051-2 UL1449 (VZCA2)	VDE 005944 UL E314979
Varistor VAR1 (alternative)	JOYIN	7N471K 10N471K 14N471K	300 Vac max.	IEC/EN 61051-2 UL1449 (VZCA2)	VDE 005937 UL E325508
Varistor VAR1 (alternative)	Walsin	VZ07D417K VZ10D417K VZ14D417K	300 Vac max.	IEC/EN 61051-2 UL1449 (VZCA2)	VDE 40010090 UL E309297
Varistor VAR1 (alternative)	SUCCESS	SVR07D471K SVR10D471K SVR14D471K	300 Vac max.	IEC/EN 61051-2 UL1449 (VZCA2)	VDE 123677 UL E330256

IEC 60601-1					
Clause	Requirement + Test			Result - Remark	Verdict
Varistor VAR1 (alternative)	BRIGHTKING	07D471K 10D471K 14D471K	300 Vac max.	IEC/EN 61051-2 UL1449 (VZCA2)	VDE 40027827 UL E327997
Diode bridge (BD1)	NANTONG HORNBY ELECTRONICS CO LTD	GBU806	8 A min. 600 V min. Mounted to heat sink HS1.	IEC/EN 60601-1 (QQQX2)	Accepted UL E216967
Diode bridge (BD1) (alternative)	Various	Various	8 A min. 600 V min. Mounted to heat sink HS1.	IEC/EN 60601-1 (QQQX2)	Accepted UL approved
Inductor (L302)	Open type construction. Differential choke, Magnet wire wound around toroidal core. 400 µH, Class B Insulation sleeving UL94-V0 placed over the windings. Fixed with glue.			IEC 60601-1	Accepted
Capacitor (C3, C4)	Various	Various	Min. 400 V Min. 1 µF	IEC 60601-1	Accepted Tested in the unit.
PFC transformer (T1)	Open type construction. Insulation Class B GTM91092-110-M-T1 (Manufacturer GLOBTEK or Various)			IEC 60601-1	Accepted
- Bobbin	+CHANG CHUN PLASTICS Co., Ltd.	T375J T373J	Phenolic UL94-V0 150°C	IEC/EN 60601-1 UL94 UL 746 (QMFZ2)	Accepted UL E59481
- Core	Various	Various	Ferrite core PQ3220	IEC/EN 60601-1	Accepted
- Wire	+PACIFIC ELECTRIC WIRE & CABLE Co., Ltd.	UEW	--	IEC/EN 60601-1 (OBMW2)	Accepted UL E201757
- Wire	+JUNG SHING WIRE Co., Ltd.	UEW-4	--	IEC/EN 60601-1 (OBMW2)	Accepted UL E174837
- Mylar tape	+3M COMPANY	1350F-1	Min. 130°C	IEC/EN 60601-1 (OANZ2)	Accepted UL E17385
- Tubing	+GREAT HOLDING INDUSTRIAL Co., Ltd.	TFL tube	VW-1, 200°C	IEC/EN 60601-1 (YDPU2)	Accepted UL E156256
PFC diode (D2)	Various	Various	8 A min. 600 V min. Mounted to heat sink HS1	IEC/EN 60601-1	Accepted

IEC 60601-1					
Clause	Requirement + Test			Result - Remark	Verdict
PFC transistor (Q3)	Various	Various	10 A min. 500 V min. Mounted to heat sink HS1	IEC/EN 60601-1	Accepted
Insulation foil (placed between HS1 and Q3 body, between HS2 and Q1 body, between HS3 and D103, D102, U106 body, placed between HS4 and D104, Q109 body)	+ BERQUIST	Sil-Pad 900S	UL94-V0 Thickness: Min. 0,229 mm 150°C	IEC/EN 60601-1 (QMFZ2)	Accepted UL E59150
Heat sink HS1 (connected to primary common)	Aluminum, L shape Overall 68 by 27 by 37 mm Min. 4 mm thick			IEC/EN 60601-1	Accepted
Bulk capacitor (C9)	Various	Various	Min.180 µF, Min. 450 V Min. 85°C	IEC/EN 60601-1	Accepted
Switching transistor (Q1)	Various	Various	10 A min. 600 V min. Mounted to heat sink HS2	IEC/EN 60601-1	Accepted
Heat sink HS2 (connected to primary common)	Aluminum, Overall 44,2 by 27 mm Min. 4 mm thick.			IEC/EN 60601-1	Accepted
Main transformer (T2) (primary to secondary)	Open type construction. Insulation Class B GTM91092-110-M-T2 (Manufacturer GLOBTEK or Various)			IEC/EN 60601-1	Accepted
- Bobbin	+CHUNG CHUN PLASTICS Co., Ltd.	T375J T373J	Phenolic UL94-V0 150°C	IEC/EN 60601-1 UL94 UL 746 (QMFZ2)	Accepted UL E59481
- Core	Various	Various	Ferrite core PQ3220	IEC/EN 60601-1	Accepted
- Wire	+PACIFIC ELECTRIC WIRE & CABLE Co., Ltd.	UEW	--	IEC/EN 60601-1 (OBMW2)	Accepted UL E201757

IEC 60601-1					
Clause	Requirement + Test			Result - Remark	Verdict
- Wire	+JUNG SHING WIRE Co., Ltd.	UEW-4	--	IEC/EN 60601-1 (OBMW2)	Accepted UL E174837
- Triple insulated wire	+FURUKAWA Co.	TEX-E	130°C	IEC/EN 60950-1 Annex U IEC/EN 60601-1 Annex L UL 1446 (OBJT2) (OBJT2)	VDE 006735 UL E206440
- Triple insulated wire (alternative)	GREAT LEOFLON INDUSTRIAL Co. Ltd.	TRW-B	130°C	IEC/EN 60950-1 Annex U IEC/EN 60601-1 Annex L (OBJT2)	VDE 136581 UL E211989
- Tube	+GREAT HOLDING INDUSTRIAL Co., Ltd.	TFL tube	200°C	IEC/EN 60950-1 (YDPU2)	Accepted UL E156256
Optical insulator (U6, U7, U300)	SHARP	PC817	Isolation voltage: 5000 Vac	EN 60747-5-2 (FPQU2)	VDE 40008087 UL E64380
Optical insulator (U6,U7,U300) (alternative)	FAIRCHILD	FOD817C H11A817B	Isolation voltage: 5000 Vac	EN 60747-5-2 (FPQU2)	VDE 40026857 UL E90700
Optical insulator (U6,U7,U300) (alternative)	COSMO ELECTRONICS Co.	KP1010C	Isolation voltage: 5000 Vac	EN 60747-5-2 (FPQU2)	VDE 101347 UL E169586
Optical insulator (U6,U7,U300) (alternative)	EVERLIGHT	EL817	Isolation voltage: 5000 Vac	EN 60747-5-2 (FPQU2)	VDE 132249 UL E214129
Optical insulator (U6,U7,U300) (alternative)	PANASONIC	ON3171	Isolation voltage: 5000 Vac	EN 60747-5-2 (FPQU2)	VDE 065697 UL E79920
Optical insulator (U6,U7,U300) (alternative)	LITEON	LTV-817	Isolation voltage: 5000 Vac	EN 60747-5-2 (FPQU2)	VDE 40015248 UL E113898
Secondary side fuses (F3, F4,F5,F6)	BUSSMAN	6125TD	F3 = T7A, 125V F4 = T3A, 125V F5 = T7A, 125V F6 = T1.5A, 125V	IEC/EN 60601-1 (JDYX2)	Accepted UL E19180

IEC 60601-1					
Clause	Requirement + Test			Result - Remark	Verdict
Secondary side fuses (F3, F4,F5,F6,F7) (alternative)	LITTELFUSE	451/453	F3 = T7 A/125V F4 = T3A/125V F5 = T7A/125V F6 = T1,5A/125V F7 = T10A/125V	IEC/EN 60601-1 (JDYX2)	Accepted UL E10480
Alternate secondary side fuses (F3, F4,F6)	LITTELFUSE	452/454	F4 = T3A/125V F6 = T1,5A/125V	IEC/EN 60601-1 (JDYX2)	Accepted UL E10480
Alternate secondary side fuses (F3, F4,F5,F6)	BELLFUSE	SST	F3 = T7A/125V F4 = T3A/125V F5 = T7A/125V F6 = T1,5A/125V	IEC/EN 60601-1 (JDYX2)	Accepted UL E20624
Alternate secondary side fuses (F3, F4,F5,F6)	CONQUER	SET	F3 = T7A/125V F4 = T3A/125V F5 = T7A/125V F6 = T1,5A/125V	IEC/EN 60601-1 (JDYX2)	Accepted UL E82636
Alternate secondary side fuses (F4,F6)	Conquer	SET	F4 = T3A/125V F6 = T1,5A/125V	IEC/EN 60601-1 (JDYX2)	Accepted UL E82636
Alternate secondary side fuse (F7)	BUSSMANN	3216TD	F7 = T10A, 32V	IEC/EN 60601-1 (JDYX2)	Accepted UL E19180
Alternate secondary side fuse (F7)	BELFUSE	SSQ	F7 = T10A, 125V	IEC/EN 60601-1 (JDYX2)	Accepted UL E20624
Alternate secondary side fuse (F7)	BUSSMANN	6125FA	F7 = T10A, 125V	IEC/EN 60601-1 (JDYX2)	Accepted UL E19180
Printed Wiring Board	Various	Various	Min V-1 130 °C Min. thickness: 1,6 mm	IEC/EN 60601-1 UL94	Accepted UL approved
Heat sink HS3	Various	Aluminum overall 73 by 27 by 4 mm thick		IEC/EN 60601-1	Accepted
Heat sink HS4	Various	Aluminum overall 73 by 27 by 4 mm thick		IEC/EN 60601-1	Accepted
Mains switch	HONGJU	R-1-210-C5N-BB	16A 250V	IEC61058-1 (WOYR2)	VDE UL E24664
Mains Switch (alternative)	NINGBO YINXIAN LIHE SWITCH FACTORY	RL1-8	16A 250V	IEC61058-1 (WOYR2)	ENEC : SE/0912 7-05 UL E208316

IEC 60601-1					
Clause	Requirement + Test			Result - Remark	Verdict
Mains Switch (alternative)	Various	Various	Min. 10A 250V	IEC61058-1 (WOYR2)	VDE approved UL approved
Primary wires	Various	Various	Min. 0,75 mm ²	IEC/EN 60601-1	Accepted UL approved
CN1 (secondary connector)	+OMRON	XC5K3231-3A	32 PINS	IEC/EN 60601-1	Accepted
Y-capacitor (C310, C311) (primary to secondary)	+ SYFER TECHNOLOGY Ltd.	Type A	Y2 capacitor (two connected in series) 4,7 nF, 250 Vac Dielectric test: 3000 Vdc / 2000 Vac	IEC384-14/2 (FOWX2)	TÜV R 60006629 UL E228790
Y-capacitor (C310, C311) (primary to secondary) (alternative)	Holy Stone	SCC2211 SCC2220	Y2 capacitor 4,7 nF, 250 Vac	IEC384-14/2 (FOWX2)	TÜV R 50005234 UL E300818
CON1 connector	MOLEX or Various	41792 or Various	250 Vac 5,0 Amax.	IEC/EN 60601-1 (ECBT2)	Accepted UL E29179
NTC RT1	Thinking Electronic Industrial Co., Ltd. Or Various	SCK1022R55 or various	Ø 10 mm - 40 to + 170°C	IEC/EN 60601-1	Accepted
Supplementary information: 1) An asterisk indicates a mark which assures the agreed level of surveillance. See Licenses and Certificates of Conformity for verification. 2) + Means, that component from other vendor and other model number, but with the same rating and equivalent approvals are accepted.					

IEC 60601-1			
Clause	Requirement + Test	Result - Remark	Verdict

8.10.1 RM RESULTS TABLE: Fixing of components			
Clause of ISO 14971	Document Ref. in RMF (Document No. & paragraph)	Result - Remarks	Verdict
4.2			
4.3			
4.4			
5			
6.2			
6.3			
6.4			
6.5			
Supplementary information: All components mounted securely. Glue used for fixing of some components. Unwanted movement of single component not result unacceptable risk.			

8.10.2 RM RESULTS TABLE: Fixing of wiring			
Clause of ISO 14971	Document Ref. in RMF (Document No. & paragraph)	Result - Remarks	Verdict
4.3			
4.4			
5			
6.2			
6.3			
6.4			
6.5			
Supplementary information: Internal conductors adequate secured.			

8.10.5 RM RESULTS TABLE: Mechanical protection of wiring			
Clause of ISO 14971	Document Ref. in RMF (Document No. & paragraph)	Result - Remarks	Verdict
4.3			
4.4			
5			
6.2			
6.3			

IEC 60601-1			
Clause	Requirement + Test	Result - Remark	Verdict

8.10.5	RM RESULTS TABLE: Mechanical protection of wiring		N/A
Clause of ISO 14971	Document Ref. in RMF (Document No. & paragraph)	Result - Remarks	Verdict
6.4			
6.5			

Supplementary information:
 There are only two ventilation fans. Internal cables protected against contact with ventilation blades. No other moving parts.

8.11.3.5	TABLE: Cord anchorages				N/A
Cord under test	Mass of equipment (kg)	Pull (N)	Torque Nm)	Remarks	

Supplementary information:
 Appliance inlet used for connection to the mains. Power supply cord not part of the investigation.

8.11.3.6	TABLE: Cord guard				N/A
Cord under test	Test mass	Measured curvature	Remarks		

Supplementary information:
 Appliance inlet used for connection to the mains. Power supply cord not part of the investigation.

8.11.5	RM RESULTS TABLE: Mains fuses and over-current releases		N/A
Clause of ISO 14971	Document Ref. in RMF (Document No. & paragraph)	Result - Remarks	Verdict
4.3			
4.4			
5			
6.2			
6.3			
6.4			
6.5			

Supplementary information:
 Primary fuses provided (Class I equipment) in both supply leads.

9.2.1	RM RESULTS TABLE: HAZARDS associated with moving parts – General	N/A
-------	--	-----

IEC 60601-1			
Clause	Requirement + Test	Result - Remark	Verdict

Clause of ISO 14971	Document Ref. in RMF (Document No. & paragraph)	Result - Remarks	Verdict
4.2			
4.3			
4.4			
5			
6.2			
6.3			
6.4			
6.5			

Supplementary information:

There are only two ventilation fans. Contact with ventilation blades prevented by design. No other moving parts provided.

9.2.2.2	TABLE: Measurement of gap “a” according to Table 20 (ISO 13852: 1996)	N/A
---------	---	-----

Part of body	Allowable adult gap ¹ , mm	Measured adult gap, mm	Allowable children gap ¹ , mm	Measured children gap, mm
Body	> 500		> 500	
Head	> 300 or < 120		> 300 or < 60	
Leg	> 180		> 180	
Foot	> 120 or < 35		> 120 or < 25	
Toes	> 50		> 50	
Arm	> 120		> 120	
Hand, wrist, fist	> 100		> 100	
Finger	> 25 or < 8		> 25 or < 4	

Supplementary information: ¹ In general, gaps for adults used, except when the device is specifically designed for use with children, values for children applied.

9.2.2.4.3	RM RESULTS TABLE: Movable guards	N/A
-----------	----------------------------------	-----

Clause of ISO 14971	Document Ref. in RMF (Document No. & paragraph)	Result - Remarks	Verdict
4.2			
4.3			
4.4			
5			
6.2			
6.3			
6.4			

IEC 60601-1			
Clause	Requirement + Test	Result - Remark	Verdict
9.2.2.4.3	RM RESULTS TABLE: Movable guards		N/A
Clause of ISO 14971	Document Ref. in RMF (Document No. & paragraph)	Result - Remarks	Verdict
6.5			
Supplementary information: /			

9.2.2.4.4	RM RESULTS TABLE: Protective measures		N/A
Clause of ISO 14971	Document Ref. in RMF (Document No. & paragraph)	Result - Remarks	Verdict
4.2			
4.3			
4.4			
5			
6.2			
6.3			
6.4			
6.5			
Supplementary information: /			

9.2.2.5 c)	RM RESULTS TABLE: Continuous activation		N/A
Clause of ISO 14971	Document Ref. in RMF (Document No. & paragraph)	Result - Remarks	Verdict
4.2			
4.3			
4.4			
5			
6.2			
6.3			
6.4			
6.5			
Supplementary information: /			

9.2.2.6	RM RESULTS TABLE: Speed of movement(s)		N/A
Clause of ISO 14971	Document Ref. in RMF (Document No. & paragraph)	Result - Remarks	Verdict
4.2			
4.3			

IEC 60601-1			
Clause	Requirement + Test	Result - Remark	Verdict
9.2.2.6	RM RESULTS TABLE: Speed of movement(s)		N/A
Clause of ISO 14971	Document Ref. in RMF (Document No. & paragraph)	Result - Remarks	Verdict
4.4			
5			
6.2			
6.3			
6.4			
6.5			
Supplementary information: /			

9.2.3.2	RM RESULTS TABLE: Over travel		N/A
Clause of ISO 14971	Document Ref. in RMF (Document No. & paragraph)	Result - Remarks	Verdict
4.2			
4.3			
4.4			
5			
6.2			
6.3			
6.4			
6.5			
Supplementary information: /			

9.2.4	RM RESULTS TABLE: Emergency stopping devices		N/A
Clause of ISO 14971	Document Ref. in RMF (Document No. & paragraph)	Result - Remarks	Verdict
4.2			
4.3			
4.4			
5			
6.2			
6.3			
6.4			
6.5			
6.6			

IEC 60601-1			
Clause	Requirement + Test	Result - Remark	Verdict
9.2.4	RM RESULTS TABLE: Emergency stopping devices		N/A
Clause of ISO 14971	Document Ref. in RMF (Document No. & paragraph)	Result - Remarks	Verdict
Supplementary information: /			

9.2.5 RM RESULTS TABLE: Release of patient			
Clause of ISO 14971	Document Ref. in RMF (Document No. & paragraph)	Result - Remarks	Verdict
4.2			
4.3			
4.4			
5			
6.2			
6.3			
6.4			
6.5			
Supplementary information: /			

9.3 RM RESULTS TABLE: Hazards associated with surfaces, corners and edges			
Clause of ISO 14971	Document Ref. in RMF (Document No. & paragraph)	Result - Remarks	Verdict
No rough surfaces, no sharp corners and no sharp edges.			P
4.3			
4.4			
5			
6.2			
6.3			
6.4			
6.5			
Supplementary information: /			

9.4.2.1 TABLE: Instability—overbalance in transport position			N/A
ME EQUIPMENT preparation	Test Condition (transport position)	Remarks	
Supplementary information: /			

IEC 60601-1			
Clause	Requirement + Test	Result - Remark	Verdict
9.4.2.2	TABLE: Instability—overbalance excluding transport position		N/A
	ME EQUIPMENT preparation	Test Condition (excluding transport position) Test either 5 ° incline and verify Warning marking or 10 ° incline)	Remarks
Supplementary information: /			

9.4.2.3	TABLE: Instability—overbalance from horizontal and vertical forces		N/A
	ME EQUIPMENT preparation	Test Condition (force used, direction of force, weight of equipment, location of force	Remarks
Supplementary information: /			

9.4.2.4.2	TABLE: Castors and wheels – Force for propulsion		N/A
	ME EQUIPMENT preparation	Test Condition (force location and height)	Remarks
Supplementary information: /			

9.4.2.4.3	TABLE: Castors and wheels – Movement over a threshold		N/A
	ME EQUIPMENT preparation	Test Condition (speed of movement)	Remarks
Supplementary information: /			

9.4.2.4.3	RM RESULTS TABLE: Movement over a threshold		N/A
Clause of ISO 14971	Document Ref. in RMF (Document No. & paragraph)	Result - Remarks	Verdict
4.2			
4.3			
4.4			
5			
6.2			
6.3			
6.4			
6.5			
Supplementary information: /			

IEC 60601-1			
Clause	Requirement + Test	Result - Remark	Verdict
9.4.3.1	TABLE: Instability from unwanted lateral movement (including sliding) in transport position		N/A
ME EQUIPMENT Preparation		Test Condition (transport position, working load, locking device(s), caster position)	Remarks
Supplementary information: /			

9.4.3.2	TABLE: Instability from unwanted lateral movement (including sliding) excluding transport position		N/A
ME EQUIPMENT Preparation		Test Condition (working load, locking device(s), caster position, force, force location, force direction)	Remarks
Supplementary information: /			

9.4.4	TABLE: Grips and other handling devices		N/A
Clause and Name of Test		Test Condition	Remarks
Supplementary information: No grips or other handling devices provided.			

9.5.1	RM RESULTS TABLE: Protective means		N/A
Clause of ISO 14971	Document Ref. in RMF (Document No. & paragraph)	Result - Remarks	Verdict
4.3			
4.4			
5			
6.2			
6.3			
6.4			
6.5			
Supplementary information: /			

9.6.1	RM RESULTS TABLE: Acoustic energy - General		N/A
Clause of ISO 14971	Document Ref. in RMF (Document No. & paragraph)	Result - Remarks	Verdict
4.2			
4.3			

IEC 60601-1			
Clause	Requirement + Test	Result - Remark	Verdict

9.6.1	RM RESULTS TABLE: Acoustic energy - General		N/A
Clause of ISO 14971	Document Ref. in RMF (Document No. & paragraph)	Result - Remarks	Verdict
4.4			
5			
6.2			
6.3			
6.4			
6.5			
Supplementary information: /			

9.6.2.2	RM RESULTS TABLE: Infrasound and ultrasound energy		N/A
Clause of ISO 14971	Document Ref. in RMF (Document No. & paragraph)	Result - Remarks	Verdict
4.2			
4.3			
4.4			
5			
6.2			
6.3			
6.4			
6.5			
Supplementary information: /			

9.7.2	RM RESULTS TABLE: Pneumatic and hydraulic parts		N/A
Clause of ISO 14971	Document Ref. in RMF (Document No. & paragraph)	Result - Remarks	Verdict
4.3			
4.4			
5			
6.2			
6.3			
6.4			
6.5			
Supplementary information: /			

9.7.4	RM RESULTS TABLE: Pressure rating of ME equipment parts	N/A
-------	---	-----

IEC 60601-1			
Clause	Requirement + Test	Result - Remark	Verdict
Clause of ISO 14971	Document Ref. in RMF (Document No. & paragraph)	Result - Remarks	Verdict
4.3			
4.4			
5			
6.2			
6.3			
6.4			
6.5			
Supplementary information: /			

9.7.5	TABLE: Pressure vessels					N/A
Hydraulic, Pneumatic or Suitable Media and Test Pressure	Vessel Burst	Permanent Deformation	Leaks	Vessel fluid substance	Remarks	
Supplementary Information: No pressure vessels provided within the equipment.						

9.7.6	RM RESULTS TABLE: Pressure-control device			N/A
Clause of ISO 14971	Document Ref. in RMF (Document No. & paragraph)	Result - Remarks	Verdict	
4.3				
4.4				
5				
6.2				
6.3				
6.4				
6.5				
Supplementary information: /				

9.7.7	RM RESULTS TABLE: Pressure-relief device			N/A
Clause of ISO 14971	Document Ref. in RMF (Document No. & paragraph)	Result - Remarks	Verdict	
4.3				
4.4				

IEC 60601-1			
Clause	Requirement + Test	Result - Remark	Verdict
9.7.7	RM RESULTS TABLE: Pressure-relief device		N/A
Clause of ISO 14971	Document Ref. in RMF (Document No. & paragraph)	Result - Remarks	Verdict
5			
6.2			
6.3			
6.4			
6.5			
Supplementary information: /			

9.8.1	RM RESULTS TABLE: Hazards associated with support systems - General		N/A
Clause of ISO 14971	Document Ref. in RMF (Document No. & paragraph)	Result - Remarks	Verdict
4.2			
4.3			
4.4			
5			
6.2			
6.3			
6.4			
6.5			
Supplementary information: /			

9.8.2	RM RESULTS TABLE: Tensile safety factor		N/A
Clause of ISO 14971	Document Ref. in RMF (Document No. & paragraph)	Result - Remarks	Verdict
4.3			
4.4			
5			
6.2			
6.3			
6.4			
6.5			
Supplementary information: /			

9.8.3.1	RM RESULTS TABLE: Strength of patient or operator support or suspension systems - General		N/A
---------	---	--	-----

IEC 60601-1			
Clause	Requirement + Test	Result - Remark	Verdict
Clause of ISO 14971	Document Ref. in RMF (Document No. & paragraph)	Result - Remarks	Verdict
4.2			
4.3			
4.4			
5			
6.2			
6.3			
6.4			
6.5			
Supplementary information: /			

9.8.3.2	TABLE: PATIENT support/suspension system - Static forces				N/A
ME EQUIPMENT part or area	Position	Load	Area	Remarks	
Supplementary Information: /					

9.8.3.2a, b	RM RESULTS TABLE: Static forces due to loading from persons			N/A
Clause of ISO 14971	Document Ref. in RMF (Document No. & paragraph)	Result - Remarks	Verdict	
4.3				
4.4				
5				
6.2				
6.3				
6.4				
6.5				
Supplementary Information: /				

9.8.3.3	TABLE: Support/Suspension System – Dynamic forces due to loading from persons				N/A
ME EQUIPMENT part or area	Position	Safe Working Load	Area	Remarks	
Supplementary Information: /					

IEC 60601-1			
Clause	Requirement + Test	Result - Remark	Verdict

9.8.4.1	RM RESULTS TABLE: Systems with mechanical protective devices - General		N/A
Clause of ISO 14971	Document Ref. in RMF (Document No. & paragraph)	Result - Remarks	Verdict
4.3			
4.4			
5			
6.2			
6.3			
6.4			
6.5			
Supplementary information: /			

9.8.4.3	RM RESULTS TABLE: Mechanical protective device for single activation		N/A
Clause of ISO 14971	Document Ref. in RMF (Document No. & paragraph)	Result - Remarks	Verdict
4.3			
4.4			
5			
6.2			
6.3			
6.4			
6.5			
Supplementary information: /			

9.8.5	RM RESULTS TABLE: Systems without mechanical protective devices		N/A
Clause of ISO 14971	Document Ref. in RMF (Document No. & paragraph)	Result - Remarks	Verdict
4.3			
4.4			
5			
6.2			
6.3			
6.4			
6.5			
Supplementary information: /			

10.1.1	TABLE: Measurement of X - radiation	N/A
--------	--	------------

IEC 60601-1			
Clause	Requirement + Test	Result - Remark	Verdict
Maximum allowable radiation pA/kg (μSv/h) (mR/h)		36 (5 μSv/h) (0.5 mR/h)	
Surface area under test Surface no./ Description ¹		Measured Radiation, pA/kg (μSv/h) (mR/h)	Remarks
1/ /			
2/ /			
3/ /			
4/ /			
5/ /			
6/ /			
7/ /			
8/ /			
9/ /			
10/ /			
Supplementary information: ¹ Measurements made at a distance of 5 cm from any surface to which OPERATOR (other than SERVICE PERSONNEL) can gain access without a TOOL, is deliberately provided with means of access, or is instructed to enter regardless of whether or not a TOOL is needed to gain access			

10.1.2	RM RESULTS TABLE: ME equipment intended to produce diagnostic or therapeutic X-radiation		N/A
Clause of ISO 14971	Document Ref. in RMF (Document No. & paragraph)	Result - Remarks	Verdict
4.2			
4.3			
4.4			
5			
6.2			
6.3			
6.4			
6.5			
Supplementary information: /			

10.2	RM RESULTS TABLE: Alpha, beta, gamma, neutron & other particle radiation		N/A
Clause of ISO 14971	Document Ref. in RMF (Document No. & paragraph)	Result - Remarks	Verdict
4.2			
4.3			
4.4			

IEC 60601-1			
Clause	Requirement + Test	Result - Remark	Verdict
10.2	RM RESULTS TABLE: Alpha, beta, gamma, neutron & other particle radiation		N/A
Clause of ISO 14971	Document Ref. in RMF (Document No. & paragraph)	Result - Remarks	Verdict
5			
6.2			
6.3			
6.4			
6.5			
Supplementary information: /			

10.3	RM RESULTS TABLE: Microwave radiation		N/A
Clause of ISO 14971	Document Ref. in RMF (Document No. & paragraph)	Result - Remarks	Verdict
4.2			
4.3			
4.4			
5			
6.2			
6.3			
6.4			
6.5			
Supplementary information: /			

10.5	RM RESULTS TABLE: Other visible electromagnetic radiation		N/A
Clause of ISO 14971	Document Ref. in RMF (Document No. & paragraph)	Result - Remarks	Verdict
4.2			
4.3			
4.4			
5			
6.2			
6.3			
6.4			
6.5			
Supplementary information: /			

IEC 60601-1			
Clause	Requirement + Test	Result - Remark	Verdict
10.6	RM RESULTS TABLE: Risk associated with infrared radiation other than emitted by lasers and LEDs		N/A
Clause of ISO 14971	Document Ref. in RMF (Document No. & paragraph)	Result - Remarks	Verdict
4.2			
4.3			
4.4			
5			
6.2			
6.3			
6.4			
6.5			
Supplementary information: /			

10.7	RM RESULTS TABLE: Risk associated with ultraviolet radiation other than emitted by lasers and LEDs		N/A
Clause of ISO 14971	Document Ref. in RMF (Document No. & paragraph)	Result - Remarks	Verdict
4.2			
4.3			
4.4			
5			
6.2			
6.3			
6.4			
6.5			
Supplementary information: /			

IEC 60601-1			
Clause	Requirement + Test	Result - Remark	Verdict

11.1.1	TABLE: Excessive temperatures in ME EQUIPMENT					P
	Supply voltage (V~)	90	100	240	264	—
	Frequency (Hz)	60	60	50	50	—
	Ambient T (°C)	55	55	55	55	—
Maximum measured temperature T of part/at:		Max measured temperature (°C)				Allowed Tmax (°C)
1) AC inlet		62,8	62,2	60,6	60,6	70
2) CON1 enclosure		65,4	64,4	61,5	61,4	70
3) L2 windings		86,1	81,4	67,7	67,3	120
4) PCB near to BD1		88,5	84,8	72,1	71,4	130
5) Capacitor C9 (near Q3)		73,7	73,2	71,9	71,8	85
6) T1 windings		88,8	84,9	71,7	70,4	120
7) PCB near to D2		82,4	79,7	71,2	70,7	130
8) PCB near to Q3		80,3	77,7	69,5	69,2	130
9) PCB near to Q1		119,0	119,0	119,8	119,8	130
10) T2 windings		109,2	109,1	108,9	108,9	120
11) T2 core		91,0	91,0	90,8	90,8	120
12) PCB neat to D103		100,1	100,0	99,8	99,7	130
13) PCB neat to D104		80,4	80,6	80,3	80,4	130
14) PCB neat to D102		88,3	88,2	88,2	88,0	130
15) PCB neat to D106		88,3	88,2	88,2	88,1	130
16) L115 windings		60,3	60,3	60,1	60,1	95
17) L101 windings		71,3	71,1	71,0	71,0	95
18) PCB near to Q101		85,1	85,2	85,0	85,0	130
19) Optocoupler U300		75,3	75,1	75,1	75,0	100
20) Electrolytic capacitor C132		64,3	64,3	64,0	63,6	85
21) T1 core		79,9	77,2	68,7	67,9	120
22) TR2 heat-sink		88,0	87,6	87,5	87,4	--
23) Enclosure front side		59,6	59,4	58,7	58,7	70
24) Mains switch		66,0	65,7	65,0	65,0	85

IEC 60601-1			
Clause	Requirement + Test	Result - Remark	Verdict

Supplementary information:

¹ Maximum allowable temperature on surfaces of test corner is 90 °C

² Max temperature determined in accordance with 11.1.3e)

³ When thermocouples used to determine temperature of windings, limits of Table 22 reduced by 10 °C.

⁴ Supply voltage:

- ME EQUIPMENT with heating elements - 110 % of the maximum RATED voltage;
- Motor operated ME EQUIPMENT - east favourable voltage between 90 % of the minimum RATED and 110 % of the maximum RATED voltage. ME EQUIPMENT operated under normal load and normal DUTY CYCLE.
- Combined heating and motor operated and other ME EQUIPMENT - tested both at 110 % of the maximum RATED voltage and at 90 % of the minimum RATED voltage.

⁵ **APPLIED PARTS** intended to supply heat to a **PATIENT** - See RISK MANAGEMENT FILE containing temperatures and clinical effects. Also, see instructions for use.

Supplementary information:

Temperature rises of the transformer was measured with thermocouples (Class B transformer provided inside the unit, 130°C - 10°C= 120°C).

The printed circuit board (PCB) is rated 130°C.

Max temperature determined in accordance with 11.1.3e).

Power supply unit is specified to be used outside the patient environmental; therefore maximum allowed temperature of accessible parts determinated from IEC/EN 60950-1 (Means of Operator Protection MOOP); therefore limit 85°C applied for plastic parts and 70°C for metal parts.

Temperature tests were performed only for reference. To be evaluated during the end medical product approval.

IEC 60601-1			
Clause	Requirement + Test	Result - Remark	Verdict

11.1.1	RM RESULTS TABLE: Maximum temperature during normal use (Table 23 or 24)		N/E
Clause of ISO 14971	Document Ref. in RMF (Document No. & paragraph)	Result - Remarks	Verdict
4.2			
4.3			
4.4			
5			
6.2			
6.3			
6.4			
6.5			
Supplementary information: The risk management requirements of the standard were not addressed.			

11.1.2.1	RM RESULTS TABLE: Applied parts intended to supply heat to patient		N/A
Clause of ISO 14971	Document Ref. in RMF (Document No. & paragraph)	Result - Remarks	Verdict
4.2			
4.3			
4.4			
5			
6.2			
6.3			
6.4			
6.5			
Supplementary information: No applied parts.			

11.1.2.2	RM RESULTS TABLE: Applied parts not intended to supply heat to patient		N/A
Clause of ISO 14971	Document Ref. in RMF (Document No. & paragraph)	Result - Remarks	Verdict
4.2			
4.3			
4.4			
5			

IEC 60601-1			
Clause	Requirement + Test	Result - Remark	Verdict
11.1.2.2	RM RESULTS TABLE: Applied parts not intended to supply heat to patient		N/A
Clause of ISO 14971	Document Ref. in RMF (Document No. & paragraph)	Result - Remarks	Verdict
6.2			
6.3			
6.4			
6.5			
Supplementary information: /			

11.1.3	TABLE: Temperature of windings by change-of-resistance method							N/A
Temperature T of winding:	t ₁ (°C)	R ₁ (Ω)	t ₂ (°C)	R ₂ (Ω)	T (°C)	Allowed T _{max} (°C)	Insulation class	
Supplementary information: Switch mode transformer incorporated. Temperature rise measured on the power transformer windings was measured on the transformer windings by thermocouple.								

11.1.3	RM RESULTS TABLE: Measurements							N/A
Clause of ISO 14971	Document Ref. in RMF (Document No. & paragraph)	Result - Remarks						Verdict
4.2								
4.3								
4.4								
5								
6.2								
6.3								
6.4								
6.5								
Supplementary information: Temperature measurements performed. Test corner used. Temperature of test corner not exceeds 90°C in normal conditions.								

11.2.2.1	RM RESULTS TABLE: Risk of fire in an oxygen rich environment							N/A
Clause of ISO 14971	Document Ref. in RMF (Document No. & paragraph)	Result - Remarks						Verdict
4.2								
4.3								
4.4								

IEC 60601-1			
Clause	Requirement + Test	Result - Remark	Verdict
11.2.2.1	RM RESULTS TABLE: Risk of fire in an oxygen rich environment		N/A
Clause of ISO 14971	Document Ref. in RMF (Document No. & paragraph)	Result - Remarks	Verdict
5			
6.2			
6.3			
6.4			
6.5			
Supplementary information: /			

11.2.2.1	TABLE: Alternative method to 11.2.2.1 a) 5) to determine existence of an ignition source		N/A
Areas where sparking might cause ignition:			Remarks
1.			
2.			
3.			
5.			
6.			
Materials of the parts between which sparks could occur (Composition, Grade Designation, Manufacturer):			Remarks
1.			
2.			
3.			
4.			
5.			
6.			
Test parameters selected representing worst case conditions for ME EQUIPMENT:			Remarks
Oxygen concentration (%):			
Fuel :			
Current (A) :			
Voltage (V) :			
Capacitance (µF) :			
Inductance or resistance (h or Ω):			
No. of trials (300 Min) :			

IEC 60601-1			
Clause	Requirement + Test	Result - Remark	Verdict

Sparks resulted in ignition (Yes/No):		
Supplementary information: Test procedure of 11.2.2.1 a) 5) & Figs 35-37 used for tests. For circuits not in Figs 35-37, test voltage or current set at 3 times the worst case values with other parameters set at worst case values to determine if ignition can occur.		

11.3	RM RESULTS TABLE: Constructional requirements for fire enclosures of ME equipment		N/A
Clause of ISO 14971	Document Ref. in RMF (Document No. & paragraph)	Result - Remarks	Verdict
4.2			
4.3			
4.4			
5			
6.2			
6.3			
6.4			
6.5			
Supplementary information: /			

11.5	RM RESULTS TABLE: ME equipment and ME systems intended for use in conjunction with flammable agents		N/A
Clause of ISO 14971	Document Ref. in RMF (Document No. & paragraph)	Result - Remarks	Verdict
4.2			
4.3			
4.4			
5			
6.2			
6.3			
6.4			
6.5			
Supplementary information: The risk management requirements of the standard were not addressed. EUT not evaluated for use in conjunction with flammable agents.			

11.6.1	TABLE: overflow, spillage, leakage, ingress of water, cleaning, disinfection, sterilization, compatibility with substances	N/A
--------	---	-----

IEC 60601-1			
Clause	Requirement + Test	Result - Remark	Verdict

Clause / Test Name	Test Condition	Part under test	Remarks

Supplementary information:

The risk management requirements of the standard were not addressed. EUT is not end medical product. Cleaning and other applicable tests shall be considered within end product investigation.

11.6.2	RM RESULTS TABLE: Overflow in ME equipment		N/E
Clause of ISO 14971	Document Ref. in RMF (Document No. & paragraph)	Result - Remarks	Verdict
4.2			
4.3			
4.4			
5			

Supplementary information:

The risk management requirements of the standard were not addressed.

11.6.3	RM RESULTS TABLE: Spillage on ME equipment and ME system		N/E
Clause of ISO 14971	Document Ref. in RMF (Document No. & paragraph)	Result - Remarks	Verdict
4.2			
4.3			
4.4			
5			
6.2			
6.3			
6.4			
6.5			

Supplementary information:

The risk management requirements of the standard were not addressed.

11.6.5	RM RESULTS TABLE: Ingress of water or particulate matter into ME EQUIPMENT and ME SYSTEMS		N/E
Clause of ISO 14971	Document Ref. in RMF (Document No. & paragraph)	Result - Remarks	Verdict
4.2			
4.3			
4.4			
5			

IEC 60601-1			
Clause	Requirement + Test	Result - Remark	Verdict
11.6.5	RM RESULTS TABLE: Ingress of water or particulate matter into ME EQUIPMENT and ME SYSTEMS		N/E
Clause of ISO 14971	Document Ref. in RMF (Document No. & paragraph)	Result - Remarks	Verdict
Supplementary information: No protection provided within the EUT. Power supply unit is intended for building-in.			

11.6.6	RM RESULTS TABLE: Cleaning and disinfection of ME equipment and ME systems		N/A
Clause of ISO 14971	Document Ref. in RMF (Document No. & paragraph)	Result - Remarks	Verdict
4.2			
4.3			
4.4			
5			
6.2			
6.3			
6.4			
6.5			
Supplementary information: The risk management requirements of the standard were not addressed. EUT is not end medical product. Cleaning and other applicable tests shall be considered within end product investigation.			

11.6.7	RM RESULTS TABLE: Sterilization of ME equipment and ME systems		N/E
Clause of ISO 14971	Document Ref. in RMF (Document No. & paragraph)	Result - Remarks	Verdict
4.2			
4.3			
4.4			
5			
6.2			
6.3			
6.4			
6.5			
Supplementary information: The risk management requirements of the standard were not addressed. EUT is not end medical product. Sterilization shall be considered within end product investigation.			

11.6.8	RM RESULTS TABLE: Compatibility with substances used	N/E
--------	---	-----

IEC 60601-1			
Clause	Requirement + Test	Result - Remark	Verdict

Clause of ISO 14971	Document Ref. in RMF (Document No. & paragraph)	Result - Remarks	Verdict
4.2			
4.3			
4.4			
5			
6.2			
6.3			
6.4			
6.5			

Supplementary information:

The risk management requirements of the standard were not addressed. EUT is not end medical product. Shall be considered within end product investigation.

12.1	RM RESULTS TABLE: Accuracy of controls and equipment		N/A
Clause of ISO 14971	Document Ref. in RMF (Document No. & paragraph)	Result - Remarks	Verdict
4.2			
4.3			
4.4			
5			
6.2			
6.3			
6.4			
6.5			

Supplementary information:

No controls provided.

12.3	RM RESULTS TABLE: Alarm systems		N/A
Clause of ISO 14971	Document Ref. in RMF (Document No. & paragraph)	Result - Remarks	Verdict
4.2			
4.3			
4.4			
5			
6.2			
6.3			

IEC 60601-1			
Clause	Requirement + Test	Result - Remark	Verdict
12.3	RM RESULTS TABLE: Alarm systems		N/A
Clause of ISO 14971	Document Ref. in RMF (Document No. & paragraph)	Result - Remarks	Verdict
6.4			
6.5			
Supplementary information: No alarm incorporated.			

12.4.1	RM RESULTS TABLE: Intentional exceeding of safety limits		N/A
Clause of ISO 14971	Document Ref. in RMF (Document No. & paragraph)	Result - Remarks	Verdict
4.2			
4.3			
4.4			
5			
6.2			
6.3			
6.4			
6.5			
Supplementary information: /			

12.4.2	RM RESULTS TABLE: Indication of parameters relevant to safety		N/A
Clause of ISO 14971	Document Ref. in RMF (Document No. & paragraph)	Result - Remarks	Verdict
4.2			
4.3			
4.4			
5			
6.2			
6.3			
6.4			
6.5			
Supplementary information: No energy delivered to the patient. Power supply intended for operator environment.			

12.4.3	RM RESULTS TABLE: Accidental selection of excessive output values		N/A
--------	--	--	-----

IEC 60601-1			
Clause	Requirement + Test	Result - Remark	Verdict
Clause of ISO 14971	Document Ref. in RMF (Document No. & paragraph)	Result - Remarks	Verdict
4.2			
4.3			
4.4			
5			
6.2			
6.3			
6.4			
6.5			
Supplementary information: /			

12.4.4		RM RESULTS TABLE: Incorrect output	N/E
Clause of ISO 14971	Document Ref. in RMF (Document No. & paragraph)	Result - Remarks	Verdict
4.2			
4.3			
4.4			
5			
6.2			
6.3			
6.4			
6.5			
Supplementary information: EUT is power supply unit with four SELV outputs and one non-SELV output. Only functional insulation between high voltage output (DC4) and other outputs provided. Short circuit between high voltage (130 Vdc max.) and other outputs performed. See table 13.2: Abnormal operation.			

12.4.5.2		RM RESULTS TABLE: Diagnostic X-ray equipment	N/A
Clause of ISO 14971	Document Ref. in RMF (Document No. & paragraph)	Result - Remarks	Verdict
4.2			
4.3			
4.4			
5			
6.2			
6.3			

IEC 60601-1			
Clause	Requirement + Test	Result - Remark	Verdict
12.4.5.2	RM RESULTS TABLE: Diagnostic X-ray equipment		N/A
Clause of ISO 14971	Document Ref. in RMF (Document No. & paragraph)	Result - Remarks	Verdict
6.4			
6.5			
Supplementary information: EUT is not diagnostic X-ray equipment.			

12.4.5.3	RM RESULTS TABLE: Radiotherapy equipment		N/A
Clause of ISO 14971	Document Ref. in RMF (Document No. & paragraph)	Result - Remarks	Verdict
4.2			
4.3			
4.4			
5			
6.2			
6.3			
6.4			
6.5			
Supplementary information: /			

12.4.5.4	RM RESULTS TABLE: Other ME equipment producing diagnostic or therapeutic radiation		N/A
Clause of ISO 14971	Document Ref. in RMF (Document No. & paragraph)	Result - Remarks	Verdict
4.2			
4.3			
4.4			
5			
6.2			
6.3			
6.4			
6.5			
Supplementary information: /			

12.4.6	RM RESULTS TABLE: Diagnostic or therapeutic acoustic pressure		N/A
Clause of ISO 14971	Document Ref. in RMF (Document No. & paragraph)	Result - Remarks	Verdict

IEC 60601-1			
Clause	Requirement + Test	Result - Remark	Verdict
12.4.6	RM RESULTS TABLE: Diagnostic or therapeutic acoustic pressure		N/A
Clause of ISO 14971	Document Ref. in RMF (Document No. & paragraph)	Result - Remarks	Verdict
4.2			
4.3			
4.4			
5			
6.2			
6.3			
6.4			
6.5			
Supplementary information: /			

13.1.2	TABLE: measurement of power or energy dissipation in parts & components to waive SINGLE FAULT CONDITIONS in 4.7, 8.1 b), 8.7.2, and 13.2.2 relative to emission of flames, molten metal, or ignitable substances			N/A
Power dissipated less than (W)		15		
Energy dissipated less than (J)		900		
Part or component tested	Measured power dissipated (W)	Calculated energy dissipated (J)	SINGLE FAULT CONDITIONS waived (Yes/No)	Remarks
Supplementary information: /				

13.2	TABLE: SINGLE FAULT CONDITIONS in accordance with 13.2.2 to 13.2.13, inclusive			P
Clause No.	Description of SINGLE FAULT CONDITION	Results observed	HAZARDOUS SITUATION (Yes/No)	
13.2.2	Electrical SINGLE FAULT CONDITIONS per Clause 8.1:	—	—	
13.2.2	Short circuit of the output DC1 (5Vdc@6A)	Power supply unit switch off immediately. No high temperature rises were observed during short circuit. No hazard. No component damaged. After restarting, unit operated normally.	No	
13.2.2	Short circuit of the output DC2 (5Vdc@6A)	Power supply unit switch off immediately. No high temperature rises were observed during short circuit. No hazard. No component damaged. After restarting, unit operated normally.	No	

IEC 60601-1			
Clause	Requirement + Test	Result - Remark	Verdict
13.2.2	Short circuit of the output DC3 (-5Vdc@1A)	Power supply unit switch off after 60 seconds (90 seconds, 40 seconds). No high temperature rises were observed during short circuit. No hazard. No component damaged. After restarting, unit operated normally.	No
13.2.2	Short circuit of the output DC4 (130Vdc@0,1A)	Power supply unit switch off immediately. No high temperature rises were observed during short circuit. No hazard. No component damaged. After restarting, unit operated normally.	No
13.2.2	Short circuit of the output DC5 (13,5Vdc@2,5A)	Power supply unit switch off immediately. No high temperature rises were observed during short circuit. No hazard. No component damaged. After restarting, unit operated normally.	No
13.2.2	Output DC 1 (5Vdc@6A) overload	Unit shut down when output current exceed 6,75 A. Max. output power at 4,4Vdc@6,65A. Unit shut down after 1h 40 min. Max. temperatures recorded (see table below for details). Other outputs at rated load. No fire, no hazard.	No
13.2.2	Output DC 2 (5Vdc@6A) overload	Unit shut down when output current exceed 5,6 A. Max. output power at 3,9Vdc@5,5A. Temperature stabilized (see table below for details). Other outputs at rated load. No fire, no hazard.	No
13.2.2	Output DC 3 (-5Vdc@1A) overload	Max. output power at 3,9Vdc@1,95A. Unit shut down after 1h. Max. temperatures recorded (see table below for details). Other outputs at rated load. No fire, no hazard.	No
13.2.2	Output DC 4 (130Vdc@0,1A)	Max. output power at 130Vdc@222mA. Temperature stabilized (see table below for details). Other outputs at rated load. No fire, no hazard.	No
13.2.2	Output DC 5 (13,5Vdc@2,5A)	Unit shut down when output current exceed 4,9 A. Max. output power at 12,4Vdc@4,9A. Temperature stabilized (see table below for details). Other outputs at rated load. No fire, no hazard.	No
13.2.2	Short circuit of the varistor VAR1	Primary fuses opened immediately. No high temperature rises were observed. No hazard. Outputs of the power supply unit rated loaded.	No
13.2.2	Short circuit of the BD1	Primary fuses opened immediately. No high temperature rises were observed. No hazard. Outputs of the power supply unit rated loaded.	No

IEC 60601-1			
Clause	Requirement + Test	Result - Remark	Verdict
13.2.2	Short circuit of the capacitor C3	Primary fuses opened immediately. No high temperature rises were observed. No hazard. Outputs of the power supply unit rated loaded.	No
13.2.2	Short circuit of the capacitor C4	Primary fuses opened immediately. No high temperature rises were observed. No hazard. Outputs of the power supply unit rated loaded.	No
13.2.2	Short circuit of the bulk capacitor C9	Primary fuses opened immediately. No high temperature rises were observed. No hazard. Outputs of the power supply unit rated loaded.	No
13.2.2	Short circuit of the optocoupler U7 (pin 1 to pin 2)	Normal operation of the equipment. No high temperature rises were observed. No hazard. Outputs of the power supply unit rated loaded. Outputs of the power supply unit rated loaded	No
13.2.2	Short circuit of the optocoupler U300 (pin 1 to pin 2)	Switch mode power supply unit switched off after 2 minutes. After restarting, the unit operated normally. No high temperature rises were observed. No hazard. Outputs of the power supply unit rated loaded	No
13.2.2	Short circuit of the optocoupler U6 (pin 3 to pin 4)	Unit shut down immediately. After removing of short unit operate normally. Same results with load and no load. No fire no hazard.	No
13.2.2	Short circuit of the optocoupler U300 (pin 3 to pin 4)	No effect on function	No
13.2.2	Short circuit of the optocoupler U7 (pin 3 to pin 4)	Unit shut down immediately. After removing of short unit stay shut down. Same results with load and no load. No fire no hazard.	No
13.2.2	Short circuit of the optocoupler U6 (pin 1 to pin 2)	Normal operation of the equipment. No high temperature rises were observed. No hazard. Outputs of the power supply unit rated loaded	No
13.2.2	Short circuit of the Q1 (drain to source)	Primary fuses opened immediately. Unit damaged. No high temperature rises were observed. No hazard. Outputs of the power supply unit rated loaded	No
13.2.2	Short circuit of the transformer T2 (pin 5 to pin 6)	Outputs switched off immediately. No component damaged. After restarting, the unit operated normally. No high temperature rises were observed. No hazard. Outputs of the power supply unit rated loaded	No

IEC 60601-1			
Clause	Requirement + Test	Result - Remark	Verdict
13.2.2	Short circuit of the transformer T2 (pin 2 to pin 4)	Primary fuses opened immediately. Unit damaged. No high temperature rises were observed. No hazard. Outputs of the power supply unit rated loaded	No
13.2.2	Short circuit between DC4 (high output voltage) and output DC1	<p>Output voltage DC1 increase from 5 Vdc to 14,0 Vmax and then dropped to 0 V. No hazard. All outputs switched down. No temperature rises were observed during short circuit. After restarting, unit operated normally.</p>	No
13.2.2	Short circuit between DC4 (high output voltage) and output DC2	<p>Output voltage DC2 increase from 5 Vdc to 16,4 Vmax and then dropped to 0 V. No hazard. All outputs switched down. No temperature rises were observed during short circuit. After restarting, unit operated normally.</p>	No

IEC 60601-1			
Clause	Requirement + Test	Result - Remark	Verdict
13.2.2	Short circuit between DC4 (high output voltage) and output DC3	<p>Output voltage DC4 increase from - 5 Vdc to 6,0 Vmax and then dropped to 0 V. No hazard. All outputs switched down. No temperature rises were observed during short circuit. After restarting, unit operated normally.</p> <p>Stopped CH1=10V DC 100:1 200ms/div (200ms/div) NORM:5K/s/s</p> <p>=Trace1= P-P 12,00V Max 6,000V Min -6,000V Rms 2,194V Freq 1,543Hz</p> <p>=Filter= =Offset= =Record Length= =Trigger= Smoothing : ON CH1 : 0,0V Main : 10K Mode : AUTO BW : FULL CH2 : 0,0V Zoom : 10K Type : EDGE CH1 5 Delay : 0,0ns Hold Off : MINIMUM</p>	No
13.2.2	Short circuit between DC4 (high output voltage) and output DC5	<p>Output voltage DC5 increase from 13,5 Vdc to 36,0 Vmax. Ripple noise 13,8 Vrms. All other outputs switched down. No temperature rises were observed during short circuit. After restarting, unit operated normally.</p> <p>Stopped CH1=20V DC 100:1 200ms/div (200ms/div) NORM:5K/s/s</p> <p>=Trace1= P-P 25,60V Max 36,00V Min 10,40V Rms 13,77V Freq ---</p> <p>=Filter= =Offset= =Record Length= =Trigger= Smoothing : OFF CH1 : 0,0V Main : 10K Mode : AUTO BW : FULL CH2 : 0,0V Zoom : 10K Type : EDGE CH1 5 Delay : 0,0ns Hold Off : MINIMUM</p>	No
13.2.2	Short Circuit Transformer T2 secondary winding (pin 7 – pin 9)	<p>Tested with rated load: Unit shut down immediately. No heating of components. After removing of short unit stay shut down.</p> <p>No load: No effect on function.</p> <p>No fire, no hazard.</p>	No
13.2.2	Short Circuit Transformer T2 secondary winding (pin 8 – pin 12)	<p>Tested with rated load: After 10 min. unit shut down. Max. temp. on transformer T2 recorded 103,0°C. After removing of short unit stay shut down.</p> <p>No load: No effect on function.</p> <p>No fire, no hazard.</p>	No

IEC 60601-1			
Clause	Requirement + Test	Result - Remark	Verdict
13.2.2	Short Circuit Transformer T2 secondary winding (pin 8 – pin 11)	Tested with rated load: After 12 min. unit shut down. R303 and R3 damaged. Unit damaged. Max. temp. on transformer T2 recorded 103,0°C. After removing of short unit stay shut down. No load: No effect on function. No fire, no hazard.	No
13.2.2	Short Circuit Transformer T2 secondary winding (pin 9 – pin 10)	Tested with rated load: After 6 s unit shut down. Max. temp. on transformer T2 recorded 83,2°C. After removing of short unit stay shut down. No fire, no hazard.	No
13.2.2	Short Circuit Transformer T2 primary winding (pin 2 – pin 4)	Unit shut down immediately. Temp. on Transformer T2 stabilized: 35,2°C No temperature rises were observed during short circuit. No fire, no hazard.	No
13.2.2	Short Circuit Transformer T2 primary winding (pin 5 – pin 6)	Test with no load. Temp. on Transformer T2 stabilized: 40,5°C. No temperature rises were observed during short circuit. No fire, no hazard.	No
13.2.2	Overload Transformer T2 secondary winding (pin 9 – after D103) Supply voltage: 90V; 60Hz	Unit shut down after 5 min.. Max. temperature on T2 recorded: 127,3°C. Other outputs rated load. No fire, no hazard.	No
13.2.2	Overload Transformer T2 secondary winding (pin 8 – after D102) Supply voltage: 90V; 60Hz	Unit shut down after 30s.. Max. temperature on T2 recorded: 114,3°C. Other outputs rated load. No fire, no hazard.	No
13.2.2	Overload Transformer T2 secondary winding (pin 8 – after D115) Supply voltage: 90V; 60Hz	Unit shut down after 10s.. No high temperatures observed. Other outputs rated load. No fire, no hazard.	No
13.2.2	Overload Transformer T2 secondary winding (pin 9 – after D106) Supply voltage: 90V; 60Hz	Unit shut down after 6 min.. Temp. on transformer T2 recorded 94,6°C. Other outputs rated load. No fire, no hazard.	No
13.2.3	Overheating of transformers per Clause 15.5:	—	—
	Transformer short circuit	See Clause 15.5.1.2 for details.	No
	Transformer overload	See Clause 15.5.1.3 for details.	No

IEC 60601-1			
Clause	Requirement + Test	Result - Remark	Verdict
13.2.4	Failure of THERMOSTATS according to 13.2.13 & 15.4.2, overloading - THERMOSTATS short circuited or interrupted, the less favourable of the two:	—	—
13.2.5	Failure of temperature limiting devices according to 13.2.13 & 15.4.2, overloading, THERMOSTATS short circuited or interrupted, the less favourable of the two:	—	—
13.2.6	Leakage of liquid - RISK MANAGEMENT FILE examined to determine the appropriate test conditions (sealed rechargeable batteries exempted)	—	—
13.2.7	Impairment of cooling that could result in a HAZARD using test method of 11.1:	—	—
	Single ventilation fans locked consecutively	See table on next pages for details.	No
	Ventilation openings on top and sides impaired by covering openings on top of ENCLOSURE or positioning of ME EQUIPMENT against walls	See table on next pages for details.	No
	Simulated blocking of filters		
	Flow of a cooling agent interrupted		
13.2.8	Locking of moving parts – Only one part locked at a time – Also see 13.2.10 below:	—	—
13.2.9	Interruption and short circuiting of motor capacitors – Motor capacitors short & open circuited ¹ – Also see 13.10	—	—
13.2.10	Additional test criteria for motor operated ME EQUIPMENT in 13.2.8 & 13.2.9:	—	—
	For every test in SINGLE FAULT CONDITION of 13.2.8 and 13.2.9, motor-operated EQUIPMENT started from COLD CONDITION at RATED voltage or at the upper limit of RATED voltage range for specified time:		

IEC 60601-1			
Clause	Requirement + Test	Result - Remark	Verdict
	Temperatures of windings determined at the end of specified test periods or at the instant of operation of fuses, THERMAL CUT-OUTS, motor protective devices		
	Temperatures measured as specified in 11.1.3 d)		
	Temperatures did not exceed limits of Table 26		
13.2.11	Failures of components in ME EQUIPMENT used in conjunction with OXYGEN RICH ENVIRONMENTS:	—	—
13.2.12	Failure of parts that might result in a MECHANICAL HAZARD (See 9 & 15.3):	—	—
Supplementary information: ¹ Test with short-circuited capacitor not performed when motor provided with a capacitor complying with IEC 60252-1 and the ME EQUIPMENT not intended for unattended use including automatic or remote control. See Attachment # and appended Table 8.10.			
Supplementary information: There was no flame, extensive smoke or melted metal during single fault testing. When components were failing, the test was repeated two times (3 times in total).			

IEC 60601-1			
Clause	Requirement + Test	Result - Remark	Verdict

13.2	TABLE: TABLE: SINGLE FAULT CONDITIONS in accordance with 13.2.2 to 13.2.13, inclusive					P	
	Supply voltage (V~)	90	90	90	90	90	—
	Frequency (Hz)	60	60	60	60	60	—
	Ambient T (°C)	55,0	55,5	55,3	55,3	54,8	—
Maximum measured temperature T of part/at:		Max measured temperature (°C)					Allowed Tmax (°C)
1) AC inlet		63,3	67,0	66,1	66,0	66,9	92,5
2) CON1 enclosure		66,3	70,8	69,5	69,2	71,4	92,5
3) L2 windings		90,7	100,5	97,8	94,6	108,4	165,0
4) PCB near to BD1		92,2	99,6	97,8	95,6	105,0	182,5
5) Capacitor C9 (near Q3)		77,0	80,1	79,2	79,1	81,3	115,0
6) T1 windings		93,0	101,0	99,8	96,1	109,3	165,0
7) PCB near to D2		86,5	92,3	90,3	88,7	96,1	182,5
8) PCB near to Q3		85,9	90,3	88,5	87,0	94,4	182,5
9) PCB near to Q1		130,8	134,6	135,0	132,0	142,7	182,5
10) T2 windings		126,1	129,0	131,7	125,7	142,1	165,0
11) T2 core		103,6	103,8	105,0	102,2	111,4	165,0
12) PCB neat to D103		105,4	107,8	107,0	112,7	117,4	182,5
13) PCB neat to D104		90,0	84,2	84,0	83,8	82,5	182,5
14) PCB neat to D102		90,6	99,7	94,3	101,2	96,0	182,5
15) PCB neat to D106		91,5	96,0	96,2	102,5	98,0	182,5
16) L115 windings		67,3	64,6	64,1	64,7	63,6	140,0
17) L101 windings		73,2	73,2	82,4	73,0	72,1	140,0
18) PCB near to Q101		92,0	88,0	89,7	87,8	86,1	182,5
19) Optocoupler U300		90,0	82,6	81,2	82,0	83,0	137,5
20) Electrolytic capacitor C132		72,7	67,0	68,3	67,2	67,2	115,0
21) T1 core		82,2	89,0	87,8	85,5	93,9	165,0
22) TR2 heat-sink		82,1	95,1	93,2	103,6	96,5	--
23) Enclosure front side		60,0	62,4	61,8	61,8	62,0	--
24) Mains switch		65,6	68,3	67,6	67,6	68,2	--
		1)	2)	3)	4)	5)	--

IEC 60601-1			
Clause	Requirement + Test	Result - Remark	Verdict

Supplementary information:

- 1) DC1 5V@6A output overload: 4,4@6,65A
- 2) DC2 5V@3A output overload: 3,9@5,5A
- 3) DC4 130V@0,1A output overload: 130V@222mA
- 4) DC3 5V@1A output overload: 3,9@1,95A
- 5) DC5 13,5V@2,5A output overload: 12,4@4,9A

Limit in accordance to Annex C is 175°C – 10°C= 165°C. 10°C were subtracted because of the measurement with the thermo probes.

IEC 60601-1			
Clause	Requirement + Test	Result - Remark	Verdict

13.2	TABLE: TABLE: SINGLE FAULT CONDITIONS in accordance with 13.2.2 to 13.2.13, inclusive				P	
	Supply voltage (V~)	90	90	--	--	—
	Frequency (Hz)	60	60	--	--	—
	Ambient T (°C)	54,7	54,7	--	--	—
Maximum measured temperature T of part/at:		Max measured temperature (°C)			Allowed Tmax (°C)	
1) AC inlet	70,0	64,1	--	--	92,5	
2) CON1 enclosure	73,6	64,7	--	--	92,5	
3) L2 windings	102,0	83,3	--	--	165,0	
4) PCB near to BD1	110,6	91,8	--	--	182,5	
5) Capacitor C9 (near Q3)	85,4	78,4	--	--	115,0	
6) T1 windings	110,2	91,2	--	--	165,0	
7) PCB near to D2	104,6	89,4	--	--	182,5	
8) PCB near to Q3	101,3	89,7	--	--	182,5	
9) PCB near to Q1	134,0	131,5	--	--	182,5	
10) T2 windings	114,1	104,5	--	--	165,0	
11) T2 core	96,6	90,8	--	--	165,0	
12) PCB neat to D103	102,4	111,5	--	--	182,5	
13) PCB neat to D104	83,0	95,0	--	--	182,5	
14) PCB neat to D102	97,1	103,0	--	--	182,5	
15) PCB neat to D106	96,3	102,5	--	--	182,5	
16) L115 windings	64,1	74,0	--	--	140,0	
17) L101 windings	74,7	79,2	--	--	140,0	
18) PCB near to Q101	81,7	95,8	--	--	182,5	
19) Optocoupler U300	93,3	97,8	--	--	137,5	
20) Electrolytic capacitor C132	73,6	80,2	--	--	115,0	
21) T1 core	99,3	68,7	--	--	165,0	
22) TR2 heat-sink	98,6	69,0	--	--	--	
23) Enclosure front side	67,0	60,9	--	--	--	
24) Mains switch	73,6	68,2	--	--	--	
	1)	2)	--	--	--	

IEC 60601-1			
Clause	Requirement + Test	Result - Remark	Verdict

Supplementary information:

1) Fan blocked
 2) Airholes closed

Temperature rises of the transformer was measured with thermocouples (Class B transformer provided inside the unit, 130°C - 10°C= 120°C).

The printed circuit board (PCB) is rated 130°C.

Max temperature determined in accordance with 11.1.3e).

Power supply unit is specified to be used outside the patient environmental; therefore maximum allowed temperature of accessible parts determined from IEC/EN 60950-1 (Means of Operator

13.2.6	RM RESULTS TABLE: Leakage of liquid		N/A
Clause of ISO 14971	Document Ref. in RMF (Document No. & paragraph)	Result - Remarks	Verdict
4.2			
4.3			
4.4			
5			
6.2			
6.3			
6.4			
6.5			

Supplementary information: /

14.1	RM RESULTS TABLE: Programmable electrical medical systems - General		N/A
Clause of ISO 14971	Document Ref. in RMF (Document No. & paragraph)	Result - Remarks	Verdict
4.2			
4.3			
4.4			
5			

Supplementary information: /

14.6.1	RM RESULTS TABLE: Identification of known and foreseeable hazards		N/A
Clause of ISO 14971	Document Ref. in RMF (Document No. & paragraph)	Result - Remarks	Verdict
4.3			

IEC 60601-1			
Clause	Requirement + Test	Result - Remark	Verdict

Supplementary information: /

14.6.2	RM RESULTS TABLE: Risk control		N/A
Clause of ISO 14971	Document Ref. in RMF (Document No. & paragraph)	Result - Remarks	Verdict
6.1			

Supplementary information: /

14.7	RM RESULTS TABLE: Requirement specification		N/A
Clause of ISO 14971	Document Ref. in RMF (Document No. & paragraph)	Result - Remarks	Verdict
6.3			

Supplementary information: /

14.8	RM RESULTS TABLE: Architecture		N/A
Clause of ISO 14971	Document Ref. in RMF (Document No. & paragraph)	Result - Remarks	Verdict
6.3			

Supplementary information: /

14.9	RM RESULTS TABLE: Design and Implementation		N/A
Clause of ISO 14971	Document Ref. in RMF (Document No. & paragraph)	Result - Remarks	Verdict
6.2			
6.3			

Supplementary information: /

14.10	RM RESULTS TABLE: Verification		N/A
Clause of ISO 14971	Document Ref. in RMF (Document No. & paragraph)	Result - Remarks	Verdict
6.3			

Supplementary information: /

14.11	RM RESULTS TABLE: PEMS validation		N/A
Clause of ISO 14971	Document Ref. in RMF (Document No. & paragraph)	Result - Remarks	Verdict
6.3			

IEC 60601-1			
Clause	Requirement + Test	Result - Remark	Verdict
14.11	RM RESULTS TABLE: PEMS validation		N/A
Clause of ISO 14971	Document Ref. in RMF (Document No. & paragraph)	Result - Remarks	Verdict
Supplementary information: /			

14.13	RM RESULTS TABLE: Connection of PEMS by NETWORK/DATA COUPLING to other equipment		N/A
Clause of ISO 14971	Document Ref. in RMF (Document No. & paragraph)	Result - Remarks	Verdict
4.2			
4.3			
4.4			
5			
6.2			
6.3			
Supplementary information: /			

15.1	RM RESULTS TABLE: Construction of ME equipment – Arrangements of controls and indicators of ME equipment		N/A
Clause of ISO 14971	Document Ref. in RMF (Document No. & paragraph)	Result - Remarks	Verdict
4.2			
4.3			
4.4			
5			
6.2			
6.3			
6.4			
6.5			
Supplementary information: End product consideration.			

15.3	TABLE: Mechanical Strength tests ¹⁾		P
Clause	Name of Test	Test conditions	Observed results/Remarks

IEC 60601-1			
Clause	Requirement + Test	Result - Remark	Verdict
15.3.2	Push Test	Force = 250 N ± 10 N for 5 s	No damage of the enclosure. No hazard after push test. Metal enclosure provided. Power supply unit is intended for building-in; therefore test performed only for reference.
15.3.3	Impact Test	Steel ball (50 mm in dia., 500 g ± 25 g) falling from a 1.3 m	No damage of the enclosure. No hazard after impact test. Metal enclosure provided. Power supply unit is intended for building-in; therefore test performed only for reference.
Supplementary information: ¹⁾ As applicable, Push, Impact, Drop, Mould Stress Relief and Rough Handling Tests (delete not applicable rows).			

15.3.2	RM RESULTS TABLE: Push test		N/A
Clause of ISO 14971	Document Ref. in RMF (Document No. & paragraph)	Result - Remarks	Verdict
4.2			
4.3			
4.4			
5			
Supplementary information: No damage of the enclosure after push test.			

15.3.3	RM RESULTS TABLE: Impact test		N/A
Clause of ISO 14971	Document Ref. in RMF (Document No. & paragraph)	Result - Remarks	Verdict
4.2			
4.3			
4.4			
5			
Supplementary information: No damage of the enclosure after impact test.			

15.3.4.2	RM RESULTS TABLE: Portable ME equipment		N/A
Clause of ISO 14971	Document Ref. in RMF (Document No. & paragraph)	Result - Remarks	Verdict
4.2			
4.3			

IEC 60601-1			
Clause	Requirement + Test	Result - Remark	Verdict
15.3.4.2	RM RESULTS TABLE: Portable ME equipment		N/A
Clause of ISO 14971	Document Ref. in RMF (Document No. & paragraph)	Result - Remarks	Verdict
4.4			
5			
Supplementary information: EUT not portable equipment.			

15.3.5	RM RESULTS TABLE: Rough handling test		N/A
Clause of ISO 14971	Document Ref. in RMF (Document No. & paragraph)	Result - Remarks	Verdict
4.2			
4.3			
4.4			
5			
Supplementary information: /			

15.4.1	RM RESULTS TABLE: Construction of connectors		N/A
Clause of ISO 14971	Document Ref. in RMF (Document No. & paragraph)	Result - Remarks	Verdict
4.2			
4.3			
4.4			
5			
6.2			
6.3			
6.4			
6.5			
Supplementary information: /			

15.4.2.1 a	RM RESULTS TABLE: THERMAL CUT-OUTS and OVER-CURRENT RELEASES		N/A
Clause of ISO 14971	Document Ref. in RMF (Document No. & paragraph)	Result - Remarks	Verdict
4.2			
4.3			
4.4			
5			

IEC 60601-1			
Clause	Requirement + Test	Result - Remark	Verdict
15.4.2.1 a	RM RESULTS TABLE: THERMAL CUT-OUTS and OVER-CURRENT RELEASES		N/A
Clause of ISO 14971	Document Ref. in RMF (Document No. & paragraph)	Result - Remarks	Verdict
Supplementary information: No such control devices incorporated.			

15.4.2.1 b	RM RESULTS TABLE: THERMAL CUT-OUTS with a safety function		N/A
Clause of ISO 14971	Document Ref. in RMF (Document No. & paragraph)	Result - Remarks	Verdict
4.2			
4.3			
4.4			
Supplementary information: No thermal cut-out incorporated.			

15.4.2.1 c	RM RESULTS TABLE: Independent non-SELF-RESETTING THERMAL CUT-OUT		N/A
Clause of ISO 14971	Document Ref. in RMF (Document No. & paragraph)	Result - Remarks	Verdict
4.2			
4.3			
4.4			
Supplementary information: No thermal cut-out incorporated.			

15.4.2.1 d	RM RESULTS TABLE: Loss of function of ME EQUIPMENT		N/E
Clause of ISO 14971	Document Ref. in RMF (Document No. & paragraph)	Result - Remarks	Verdict
4.2			
4.3			
4.4			
Supplementary information: The risk management requirements of the standard were not addressed.			

15.4.2.1 h	RM RESULTS TABLE: ME EQUIPMENT with tubular heating elements		N/A
Clause of ISO 14971	Document Ref. in RMF (Document No. & paragraph)	Result - Remarks	Verdict
4.2			
4.3			

IEC 60601-1			
Clause	Requirement + Test	Result - Remark	Verdict
15.4.2.1 h	RM RESULTS TABLE: ME EQUIPMENT with tubular heating elements		N/A
Clause of ISO 14971	Document Ref. in RMF (Document No. & paragraph)	Result - Remarks	Verdict
4.4			
Supplementary information: /			

15.4.3.1	RM RESULTS TABLE: Housing		N/A
Clause of ISO 14971	Document Ref. in RMF (Document No. & paragraph)	Result - Remarks	Verdict
4.2			
4.3			
4.4			
Supplementary information: /			

15.4.3.2	RM RESULTS TABLE: Connection		N/A
Clause of ISO 14971	Document Ref. in RMF (Document No. & paragraph)	Result - Remarks	Verdict
4.2			
4.3			
4.4			
Supplementary information: /			

15.4.3.3	RM RESULTS TABLE: Protection against overcharging		N/A
Clause of ISO 14971	Document Ref. in RMF (Document No. & paragraph)	Result - Remarks	Verdict
4.2			
4.3			
4.4			
Supplementary information: /			

15.4.3.4	RM RESULTS TABLE: Lithium batteries		N/A
Clause of ISO 14971	Document Ref. in RMF (Document No. & paragraph)	Result - Remarks	Verdict
4.2			
4.3			
4.4			
Supplementary information: /			

IEC 60601-1			
Clause	Requirement + Test	Result - Remark	Verdict
15.4.3.5	RM RESULTS TABLE: Excessive current and voltage protection		N/A
Clause of ISO 14971	Document Ref. in RMF (Document No. & paragraph)	Result - Remarks	Verdict
4.2			
4.3			
4.4			
5			
6.2			
6.3			
6.4			
6.5			
Supplementary information: /			

15.4.4	RM RESULTS TABLE: Indicators		N/E
Clause of ISO 14971	Document Ref. in RMF (Document No. & paragraph)	Result - Remarks	Verdict
4.2			
4.3			
4.4			
Supplementary information: The risk management requirements of the standard were not addressed. EUT is not end medical product.			

15.4.5	RM RESULTS TABLE: Pre-set controls		N/A
Clause of ISO 14971	Document Ref. in RMF (Document No. & paragraph)	Result - Remarks	Verdict
4.2			
4.3			
4.4			
5			
6.2			
6.3			
6.4			
6.5			
Supplementary information: No pre-set controls provided.			

IEC 60601-1						
Clause	Requirement + Test				Result - Remark	Verdict
15.4.6	TABLE: actuating parts of controls of ME EQUIPMENT – torque & axial pull tests					N/A
Rotating control under test	Gripping diameter “d” of control knob (mm) ¹	Torque from Table 30 (Nm)	Axial force applied (N)	Unacceptable RISK occurred Yes/No	Remarks	
Supplementary information: ¹ Gripping diameter (d) is the maximum width of a control knob regardless of its shape (e.g. control knob with pointer)						

15.4.7.3 b	RM RESULTS TABLE: Entry of liquids			N/A
Clause of ISO 14971	Document Ref. in RMF (Document No. & paragraph)	Result - Remarks		Verdict
4.2				
4.3				
4.4				
Supplementary information: /				

15.5.1.2	TABLE: transformer short circuit test short-circuit applied at end of windings or at the first point that could be short circuited under SINGLE FAULT CONDITION						P
Primary voltage (most adverse value from 90 % to 110 % of RATED voltage)(V) ¹				264	—		
RATED input frequency (Hz).....				50	—		
Winding tested	Class of insulation (A, B, E, F, or H)	Type of protective device (fuse, circuit breaker) /Ratings	Protective device operated Yes/No	Time to THERMAL STABILITY (when protective device did not operate)(Min)	Maximum allowed temp from Table 31 (°C)	Maximum winding temp measured (°C)	Ambient (°C)
Transformer T2 (shorted pin 7 – pin 9)	Class B	Primary fuses	No	3 min	165	1)*	24,0
Transformer T2 (shorted pin 12 – pin 8)	Class B	Primary fuses	No	10 min	165	102	24,0
Transformer T2 (shorted pin 8 – pin 11)	Class B	Primary fuses	No	12 min	165	103	24,0
Transformer T2 (shorted pin 9 – pin 10)	Class B	Primary fuses	No	6 min	165	94,6	24,0
Transformer T2 (shorted pin 2 – pin 4)	Class B	Primary fuses	No	20 min	165	35,2	24,0

IEC 60601-1							
Clause	Requirement + Test				Result - Remark		Verdict

Transformer T2 (shorted pin 5 – pin 6)	Class B	Primary fuses	No	20 min	165	40,6	24,0
--	---------	---------------	----	--------	-----	------	------

Supplementary information:

¹ Loads on other windings between no load and their NORMAL USE load. Short-circuit applied at end of windings or at the first point that could be short circuited under SINGLE FAULT CONDITION.

Supplementary information:

1)* Unit shut down. No heating of Transformer T2. No high temperature observed. No fire, no hazard.

See table 13.2: TABLE: single fault conditions in accordance with 13.2.2 to 13.2.13, inclusive for details.

15.5.1.3	TABLE: transformer overload test – conducted only when protective device under short-circuit test operated	P
----------	--	---

Primary voltage, most adverse value between 90 % to 110 % of RATED voltage (V) ¹ ...:	90 Vac
--	--------

RATED input frequency (Hz).....:	50
----------------------------------	----

Test current just below minimum current that would activate protective device & achieve THERMAL STABILITY under method a) (A).....:	--
---	----

Test current based on Table 32 when protective device that operated under method a) is external to transformer, and it was shunted (A).....:	--
--	----

Winding tested	Class of insulation (A, B, E, F, H)	Type of protective device used (fuse, circuit breaker)/Ratings	Maximum allowed temp from Table 31 (°C)	Maximum winding temp measured (°C)	Ambient (°C)
Transformer T2 (pin 9 – after D103)	Class B	Primary fuses	165	127,3	24
Transformer T2 (pin 8 – after D102)	Class B	Primary fuses	165	114,3	24
Transformer T2 (pin 8 – after D108)	Class B	Primary fuses	165	1)*	24
Transformer T2 (pin 8 – after D108)	Class B	Primary fuses	165	83,2	24

Supplementary information:

¹ Loads on other windings between no load and their NORMAL USE load.

Time durations: - IEC 60127-1 fuse: 30 min at current from Table 32.

Non IEC 60127-1 fuse: 30 min at the current based on characteristics supplied by fuse manufacturer, specifically, 30 min clearing-time current. When no 30 min clearing-time current data available, test current from Table 32 used until THERMAL STABILITY achieved.

- Other types of protective devices: until THERMAL STABILITY achieved at a current just below minimum current operating the protective device in a). This portion concluded at specified time or when a second protective device opened.

IEC 60601-1			
Clause	Requirement + Test	Result - Remark	Verdict

Supplementary information:
 Protective device not operated.
 Limit in accordance to Annex C is 175°C – 10°C= 165°C. 10°C were subtracted because of the measurement with the thermo probes.
 1)* Unit shut down after 10s. No high temperatures observed. No fire, no hazard.
 See table 13.2: TABLE: single fault conditions in accordance with 13.2.2 to 13.2.13, inclusive for details

15.5.2	TABLE: Transformer dielectric strength after humidity preconditioning of 5.7					N/A
Transformer Model/Type/ Part No	Test voltage applied between	Test voltage, (V)	Test frequency (Hz)	Breakdown Yes/No	Deterioration Yes/No	
	Primary & secondary windings					
	Primary winding & frame					
	Secondary winding & frame					

Supplementary information: Tests conducted under the conditions of 11.1, in ME EQUIPMENT or under simulated conditions on the bench. See Clause 15.5.2 for test parameters & other details

Supplementary information:
 Switch mode transformer incorporated within the equipment; therefore dielectric strength test on the transformer performed according to Clause 8.8.3.

16.1	RM RESULTS TABLE: General requirements for ME Systems			N/A
Clause of ISO 14971	Document Ref. in RMF (Document No. & paragraph)	Result - Remarks		Verdict
4.2				
4.3				
4.4				
5				

Supplementary information: /

16.6.1	TABLE: LEAKAGE CURRENTS in ME SYSTEM _ TOUCH CURRENT MEASUREMENTS				N/A
Specific area where TOUCH CURRENT measured (i.e., from or between parts of ME SYSTEM within PATIENT ENVIRONMENT)	Allowable TOUCH CURRENT in NORMAL CONDITION (µA)	Measured TOUCH CURRENT in NORMAL CONDITION (µA)	Allowable TOUCH CURRENT in event of interruption of PROTECTIVE EARTH CONDUCTOR, (µA)	Measured TOUCH CURRENT in event of interruption of PROTECTIVE EARTH CONDUCTOR, (µA)	
	100		500		
	100		500		
	100		500		
	100		500		

IEC 60601-1			
Clause	Requirement + Test	Result - Remark	Verdict
	100	500	
Supplementary information: /			

16.9.1	RM RESULTS TABLE: Connection terminals and connectors		N/A
Clause of ISO 14971	Document Ref. in RMF (Document No. & paragraph)	Result - Remarks	Verdict
4.2			
4.3			
4.4			
5			
6.2			
6.3			
6.4			
6.5			
Supplementary information: /			

17	RM RESULTS TABLE: Electromagnetic compatibility of ME equipment and ME systems		N/A
Clause of ISO 14971	Document Ref. in RMF (Document No. & paragraph)	Result - Remarks	Verdict
4.2			
4.3			
4.4			
5			
6.2			
6.3			
6.4			
6.5			
Supplementary information: Power supply unit is not end medical product. End product consideration.			

SP	TABLE: Additional or special tests conducted		N/A
Clause and Name of Test	Test type and condition	Observed results	
Supplementary information: No additional tests were performed.			

Enclosure No. 1

National Differences to IEC 60601-1:2005

(1 pages including this cover page)

National Differences			
Clause	Requirement + Test	Result - Remark	Verdict

US NATIONAL DIFFERENCES to IEC 60601-1 Third edition National standard ANSI/AAMI ES60601-1: 2005			
4.8	Components of ME EQUIPMENT	--	P
	When no relevant US ANSI standard existed, the requirements of this standard applied	Considered.	P
4.10.2.	SUPPLY MAINS for ME EQUIPMENT and ME SYSTEMS	--	P
	Replacement: Reference to "500 V" replaced with "600 V" in the second and third dashes to agree with the National Electrical Code (NEC) "and the NEC" added after the reference to "IEC 60364-4-41" in the text of the second-to-last dash of this sub-clause to agree with NEC	Considered.	P
8.2	Requirements related to power sources	--	N/A
	Addition to agree with NEC: The requirement, "ALL FIXED ME EQUIPMENT and PERMANENTLY INSTALLED ME EQUIPMENT are CLASS I ME EQUIPMENT"	Power supply unit is intended for building-in. End product consideration.	N/A
8.7.3	Allowable values:	--	P
	Deleted the second sentence and note to sub-clause 8.7.3 d) to read as follows to agree with NFPA 99 which does not permit for allowances larger than the stated values:	--	P
	d) The allowable values of the EARTH LEAKAGE CURRENT are 5 mA in NORMAL CONDITION and 10 mA in SINGLE FAULT CONDITION	--	P
8.11.	MAINS PARTS, components and layout	--	N/A
	Addition to agree with NEC:	--	N/A
	The requirement, "Permanently connected ME EQUIPMENT shall have provision for the connection of one of the wiring systems that is in accordance with the NEC" Fixed and stationary X-ray ME EQUIPMENT supplied from a branch circuit rated at 30 A or less, and ME EQUIPMENT not strictly portable but obviously intended to be stationary, considered acceptable when supply connection provided with a length of attached Type S hard service flexible cord, or equivalent:	EUT is not permanently connected equipment. It is intended for building-in.	N/A
	Installation of connecting cords between EQUIPMENT parts comply with NEC, as applicable	Connecting cord between equipment parts within end medical product not part of the investigation.	N/A

National Differences			
Clause	Requirement + Test	Result - Remark	Verdict
	<p>Cable used as external interconnection between units was:</p> <p>1) Type SJT, SJTO, SJO, ST, SO, STO, or equivalent flexible cord when exposed to abuse, or similar multiple-conductor appliance-wiring material such as computer cable:</p> <p>2) The cable was as in item 1) above when not exposed to abuse, or it was</p> <p> i) Type SPT-2, SP-2, or SPE-2, or equivalent</p> <p> ii) Type SVr, SVRO, SVE, or equivalent flexible cord or similar multiple-conductor appliance wiring material,</p> <p> Or, ii) An assembly of insulated wires each with a nominal insulation thickness of 0.8 mm (1/32 inch) or more, enclosed in acceptable insulating tubing having a nominal wall thickness of 0.8 mm (1/32 inch) or more.</p>	--	N/A
	<p>Receptacles provided as part of ME EQUIPMENT or ME SYSTEMS for use in the patient care areas of pediatric wards, rooms, or areas are listed (e.g., UL Certified) tamper resistant or employ a listed (e.g., UL Certified) tamper resistant cover in accordance with NEC</p>	--	N/A
8.11.3.2.	<p>Addition to agree with NEC:</p>	<p>Power supply cord not part of the investigation.</p>	N/A
	<p>The flexible cord is a type acceptable for the particular application, and it is acceptable for use at a voltage not less than the rated voltage of the appliance and has an ampacity as in NEC, not less than the current rating of the appliance.</p>	--	N/A
<p>CANADA NATIONAL DIFFERENCES to IEC 60601-1 Third edition National standard CAN/CSA-C22.2 No. 60601-1:08</p>			
1.1	<p>Scope</p>	--	P

National Differences			
Clause	Requirement + Test	Result - Remark	Verdict
	<p>This standard applies to the BASIC SAFETY and ESSENTIAL PERFORMANCE of MEDICAL ELECTRICAL EQUIPMENT and MEDICAL ELECTRICAL SYSTEMS designed to be installed in accordance with the Canadian Electrical Code (CEC), Part I, CSA C22.1; CAN/CSA-C22.2 No. 0; and CAN/CSA-Z32.</p> <p>NOTE 1A: In the IEC 60601 standards series adopted for use in Canada, the Canadian-particular standards may modify, replace, or delete requirements contained in this standard as appropriate for the particular ME EQUIPMENT and ME SYSTEMS under consideration, and may add other BASIC SAFETY and ESSENTIAL PERFORMANCE requirements.</p>	Considered.	P
1.3	Collateral standards	--	P
	<p>Applicable Canadian collateral standards become normative at the date of their publication and apply together with this standard.</p> <p>NOTE 1: When evaluating compliance with CAN/CSA-C22.2 No. 60601-1, it is permissible to assess independently compliance with the adopted Canadian collateral standards</p>	Considered.	P
1.4	Particular standards	--	P
	A requirement of a Canadian-particular safety standard takes precedence over this standard.	Considered.	P
2	<p>Normative references</p> <p>The following referenced documents are indispensable for the application of this document.</p> <p>For dated references, the applicable corresponding Canadian adopted IEC standards shall take precedence. For undated references, the latest edition of the referenced document (including any amendments) applies. All Canadian adopted IEC part 2 standards are referenced with the date of publication.</p>	Considered.	P

National Differences			
Clause	Requirement + Test	Result - Remark	Verdict
	<p>CSA (Canadian Standards Association)</p> <p>B51-03: Boiler, pressure vessel, and pressure piping code</p> <p>C22.1-06: Canadian Electrical Code, Part I</p> <p>CAN/CSA-C22.2 No. 0-M91 (R2006): General requirements — Canadian Electrical Code, Part II</p> <p>C22.2 No. 21-95 (R2004): Cord sets and power supply cords</p> <p>C22.2 No. 42-99 (R2004): General use receptacles, attachment plugs, and similar wiring devices</p> <p>C22.2 No. 49-06: Flexible cords and cables</p> <p>CAN/CSA-E61558-2-1:03: Safety of power transformers, power supply units and similar — Part 2: Particular requirements for separating transformers for general use</p> <p>CAN/CSA-Z32-04: Electrical safety and essential electrical systems in health care facilities</p>	<p>Considered.</p>	<p>P</p>

National Differences			
Clause	Requirement + Test	Result - Remark	Verdict
	<p>Z305 series of Standards:</p> <p>CAN/CSA-Z305.1-92 (R2001): Non-flammable medical gas piping systems</p> <p>CAN/CSA-Z305.6-92 (R2007): Medical oxygen concentrator central supply system for use with non-flammable medical gas piping systems</p> <p>CAN/CSA-Z305.8-03. Medical supply units</p> <p>CAN/CSA-Z305.12-98 (R2004): Guide for the safe storage, handling and use of portable oxygen systems in home, domiciliary and healthcare settings</p> <p>CAN/CSA-Z5359-04: Low pressure hose assemblies for use with medical gases</p> <p>CAN/CSA-Z9170-1-00 (R2005): Terminal units for medical gas pipeline systems — Part 1: Terminal units for use with compressed medical gases and vacuum</p> <p>CAN/CSA-Z9170-2-00 (R2005): Terminal units for medical gas pipeline systems — Part 2: Terminal units for anaesthetic gas scavenging systems</p> <p>CAN/CSA-Z9170-2-00 (R2005): Terminal units for medical gas pipeline systems — Part 2: Terminal units for anaesthetic gas scavenging systems</p> <p>CAN/CSA-Z15002-02 (R2007): Flow-metering devices for connection to terminal units of medical gas pipeline systems</p> <p>ASME International (American Society of Mechanical Engineers)</p> <p>PTC 25-2001: Pressure Relief Devices</p> <p>CGA (Compressed Gas Association):</p> <p>V-1-2005: Standard for Compressed Gas Cylinder Valve Outlet and Inlet Connections</p> <p>V-5-2005: Diameter Index Safety System (Non interchangeable Low Pressure Connections for Medical Gas Applications)</p>	<p>Considered.</p>	<p>P</p>
	<p>ISO (International Organization for Standardization)</p> <p>32:1977: Gas cylinders for medical use — Marking for identification of content</p> <p>407:2004: Small medical gas cylinders — Pin-index yoke-type valve connections</p>	<p>--</p>	<p>N/A</p>
<p>3.41</p>	<p>HIGH VOLTAGE</p>	<p>--</p>	<p>N/A</p>

National Differences			
Clause	Requirement + Test	Result - Remark	Verdict
	any voltage above 750 V, 1 050 V peak, as defined in the Canadian Electrical Code (CEC), Part I	No such high voltage within the equipment.	N/A
4.8	Components of ME EQUIPMENT	--	P
	a) the applicable safety requirements of a relevant CSA, IEC, or ISO standard; NOTE 1: For the components, it is not necessary to carry out identical or equivalent tests already performed to check compliance with the component standard.	Considered.	P
	b) where there is no relevant CSA, IEC, or ISO standard, the requirements of this standard have to be applied NOTE 2: If there are neither requirements in this standard nor in a CSA, IEC, or ISO standard, any other applicable source (e.g., standards for other types of devices, national standards) could be used to demonstrate compliance with the RISK MANAGEMENT PROCESS.	Considered.	P
4.10.2	SUPPLY MAINS for ME EQUIPMENT and ME SYSTEMS	--	P
	and shall be in accordance with the Canadian Electrical Code (CEC), Part I, CSA C22.1:	--	P
7.7.1 to 7.7.5	A PROTECTIVE EARTH CONDUCTOR or a PROTECTIVE EARTH CONNECTION or insulation shall be identified by either green or green and yellow colour. Colours of neutral and POWER SUPPLY CORD conductors shall be in accordance with the Canadian Electrical Code (CEC), Part I, CSA C22.2 No. 21, and CSA C22.2 No. 49.	Internal protective earth conductor. Power supply unit is provided with appliance inlet for connection to the mains. Power supply cord not part of the investigation.	N/A
8.7.3	Allowable values Allowable values shall be in accordance with the Canadian Electrical Code (CEC), Part I, CSA C22.1.	Considered.	P
8.11.3.2	POWER SUPPLY CORDS Types	--	N/A

National Differences			
Clause	Requirement + Test	Result - Remark	Verdict
	<p>a) The MAINS PLUG of non-PERMANENTLY INSTALLED EQUIPMENT shall be</p> <p>i) if molded-on type, hospital grade mains plug complying with CSA C22.2 No. 21;</p> <p>j) hospital grade disassembly attachment plug type complying with CSA C22.2 No. 42; or</p> <p>k) Class II equipment having fuses on the line side/sides and neutral and may use a non-polarized attachment plug or a polarized attachment plug — CSA configuration type 1-15P shall be required and shall meet all applicable requirements in CSA C22.2 No. 21 and CSA C22.2 No. 42. Where a polarized attachment plug is used, the POWER SUPPLY CORD shall be connected to the wiring of the EQUIPMENT on the ungrounded side of the line when any of the following devices are used in the primary circuit:</p> <p>1- the centre contact of an Edison base lamp holder;</p> <p>2- a single pole switch;</p> <p>3- an automatic control with a marked off position;</p> <p>4- a solitary fuse/fuse holder; or</p> <p>5- any other single pole over-current protective device</p>	<p>Power supply cord not part of the investigation.</p>	<p>N/A</p>
	<p>b) Detachable POWER SUPPLY CORD for non-PERMANENTLY INSTALLED EQUIPMENT (cord-connected equipment) shall be of a type that</p> <p>i) can be shown to be unlikely to become detached accidentally, unless it can be shown that detachment will not constitute a safety HAZARD to a PATIENT or OPERATOR;</p> <p>j) can be shown that the impedance of the earth (ground) circuit contacts will not constitute a safety HAZARD to a PATIENT or OPERATOR; and</p> <p>k) has a terminal configuration or other constructional feature that will minimize the possibility of its replacement by a detachable POWER SUPPLY CORD which could create a HAZARDOUS SITUATION</p>	<p>Power supply cord not part of the investigation.</p>	<p>N/A</p>

National Differences			
Clause	Requirement + Test	Result - Remark	Verdict
	<p>c) A detachable POWER SUPPLY CORD shall</p> <p>i) comply with the applicable requirements of CSA C22.2 No. 21; and</p> <p>j) not be smaller than No. 18 AWG, and the mechanical serviceability shall be not less than</p> <p>1) Type SJ or equivalent for mobile or exposed to abuse ME EQUIPMENT; and</p> <p>2) Type SV or equivalent for ME EQUIPMENT not exposed to abuse (or Type HPN if required because of temperature).</p> <p>NOTE 1A: See CSA C22.2 No. 49 for requirements on the cord types mentioned in Sub-item 2).</p>	Power supply cord not part of the investigation.	N/A
	<p>d) Power supply cords shall meet the requirements of the Canadian Electrical Code, Part I, as applicable.</p> <p>Connecting cords between equipment parts shall meet the requirements of the Canadian Electrical Code, Part I, as applicable.</p>	Power supply cord not part of the investigation.	N/A
8.11.5	<p>Mains fuses and OVER-CURRENT RELEASES</p> <p>Mains fuses and OVER-CURRENT RELEASES shall be in accordance with the Canadian Electrical Code (CEC), Part I, CSA C22.1.</p>	See list of critical components.	P
9.7.5	<p>Pressure vessels</p> <p>Pressure vessels shall comply with the requirements of CSA B51, as applicable.</p>	No pressure vessels provided.	N/A
9.7.7	<p>Pressure-relief device</p> <p>A pressure-relief device shall also comply as applicable to the requirements of ASME PTC 25 or equivalent Canadian requirements.</p>	No pressure-relief devices provided.	N/A

National Differences			
Clause	Requirement + Test	Result - Remark	Verdict
15.4.1	<p>Construction of connectors</p> <p>The point of connection of gas cylinders to EQUIPMENT shall be gas specific and clearly identified so that errors are avoided when a replacement is made. Medical gas inlet connectors on EQUIPMENT shall be</p> <p>i) gas specific, yoke type, or nut and nipple type valve connections complying with CGA V-1 for pressures over 1 380 kPa (200 psi); or</p> <p>DISS type complying with CGA V-5 for pressures 1 380 kPa (200 psi) or less and configured to permit the supply of medical gases from low-pressure connecting assemblies complying with CAN/CSA-Z5359.</p> <p>NOTE 1A: Users of this standard should consult the CSA Z305 series of standards, CAN/CSA-Z9170-1, CAN/CSA-Z9170-2, CAN/CSA-Z10524, and CAN/CSA-Z15002 for further information regarding inlet connectors; ISO 407 for requirements addressing yoke-type valve connections; and ISO 32 for colour coding.</p>	No gas cylinders provided.	N/A
15.4.8	<p>Internal wiring of ME EQUIPMENT</p> <p>Internal wiring of ME EQUIPMENT shall be in accordance with the Canadian Electrical Code (CEC), Part I, CSA C22.1.</p>	--	P
16.1	<p>MULTIPLE SOCKET OUTLET</p> <p>The MULTIPLE SOCKET-OUTLET shall comply with the requirements of CSA C22.2 No. 42, CSA C22.2 No. 49, and the following requirements.</p> <ul style="list-style-type: none"> - The separating transformer shall comply with the requirements of CAN/CSA-E61558-2-1 with a rated output not exceeding - 1 kVA for single-phase transformers; and - 5 kVA for polyphase transformers <p>The separating transformer shall also have a degree of protection not exceeding IPX4.</p>	No multiple socket outlets provided.	N/A
<p>SWITZERLAND NATIONAL DIFFERENCES to IEC 60601-1 Third edition National standard SN EN 60601-1:06</p>			
4	<p>Ordinance on environmentally hazardous substances SR 814.081, Annex 1.7,</p> <p>Mercury - Annex 1.7 of SR 814.81 applies for mercury.</p>	No mercury used during normal use of the equipment.	N/A

National Differences			
Clause	Requirement + Test	Result - Remark	Verdict
	Switches containing mercury such as thermostats, relays and level controllers are not allowed.	--	N/A
	Ordinance on chemical hazardous risk reduction SR 814.81, Annex 2.15: Batteries	--	N/A
	Annex 2.15 of SR 814.81 applies for batteries containing cadmium and mercury.	No batteries incorporated.	N/A
	Note: Ordinance relating to environmentally hazardous substances, SR 814.013 of 1986-06-09 is not longer in force and superseded by SR 814.81 of 2009-02-01 (ChemRRV).	--	N/A
	Supply cords of portable electrical appliances having a rated current not exceeding 10 A shall be provided with a plug complying with IEC 60884-1(3.ed.) + am1, SEV 1011 and one of the following dimension sheets: - SEV 6533-2:2009 Plug type 11, L + N, 250V 10A - SEV 6534-2:2009 Plug type 12, L + N + PE, 250V 10A - SEV 6532-2:2009 Plug type 15, 3L + N + PE, 250/400V 10A	Power supply cord not part of the investigation.	N/A
4	Supply cords of portable electrical appliances having a rated current not exceeding 16 A shall be provided with a plug complying with IEC 60884-1(3.ed.) + am1, SEV 1011 and one of the following dimension sheets: - SEV 5933-2:2009 Plug type 21 L + N, 250 V, 16A - SEV 5934-2:2009 Plug type 23 L + N + PE, 250 V, 16A - SEV 5932-2:2009 Plug type 25 3L + N + PE, 250/400V 16A	Power supply cord not part of the investigation..	N/A
	NOTE 16 A plugs are not often used in Swiss domestic installation system.	--	N/A
	See TRF template regulatory requirements Switzerland on IECEE Website R.R. TRF templates.	--	N/A

Enclosure No. 2

Photo documentation

(6 pages including this cover page)

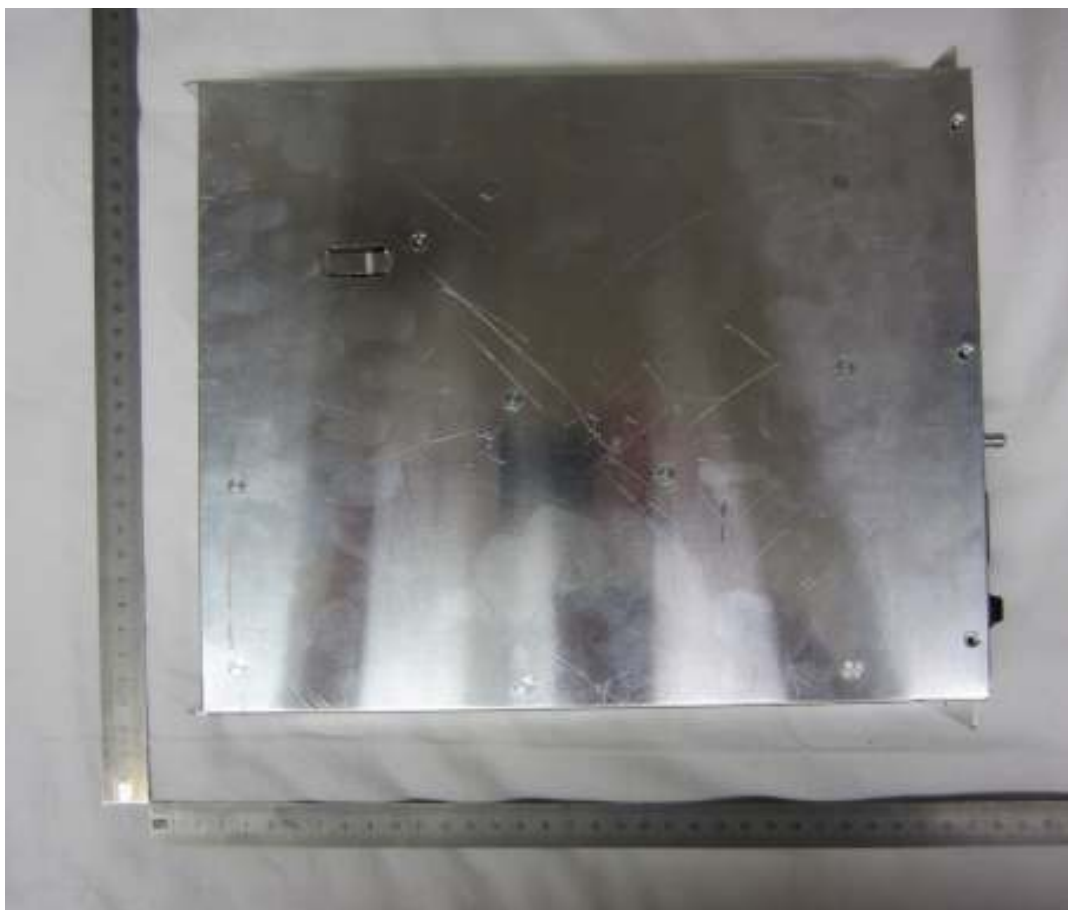







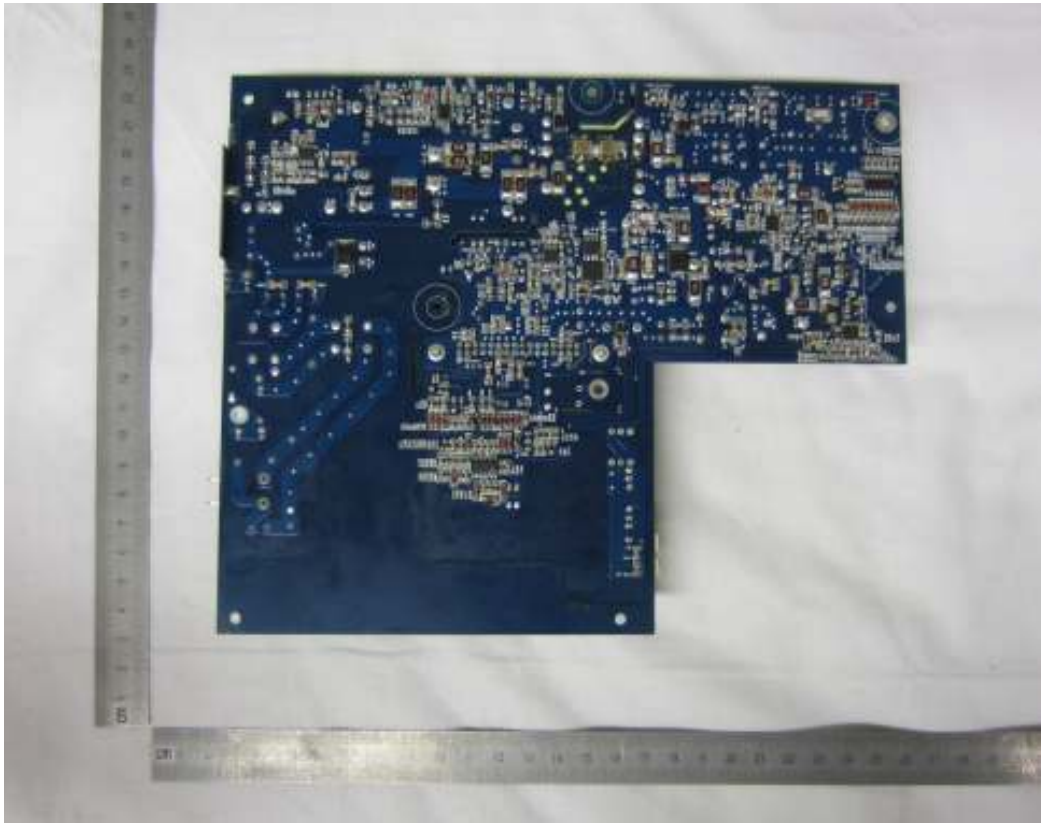

Enclosure No. 3

Schematics, layouts and transformer drawings

(47 pages including this cover page)

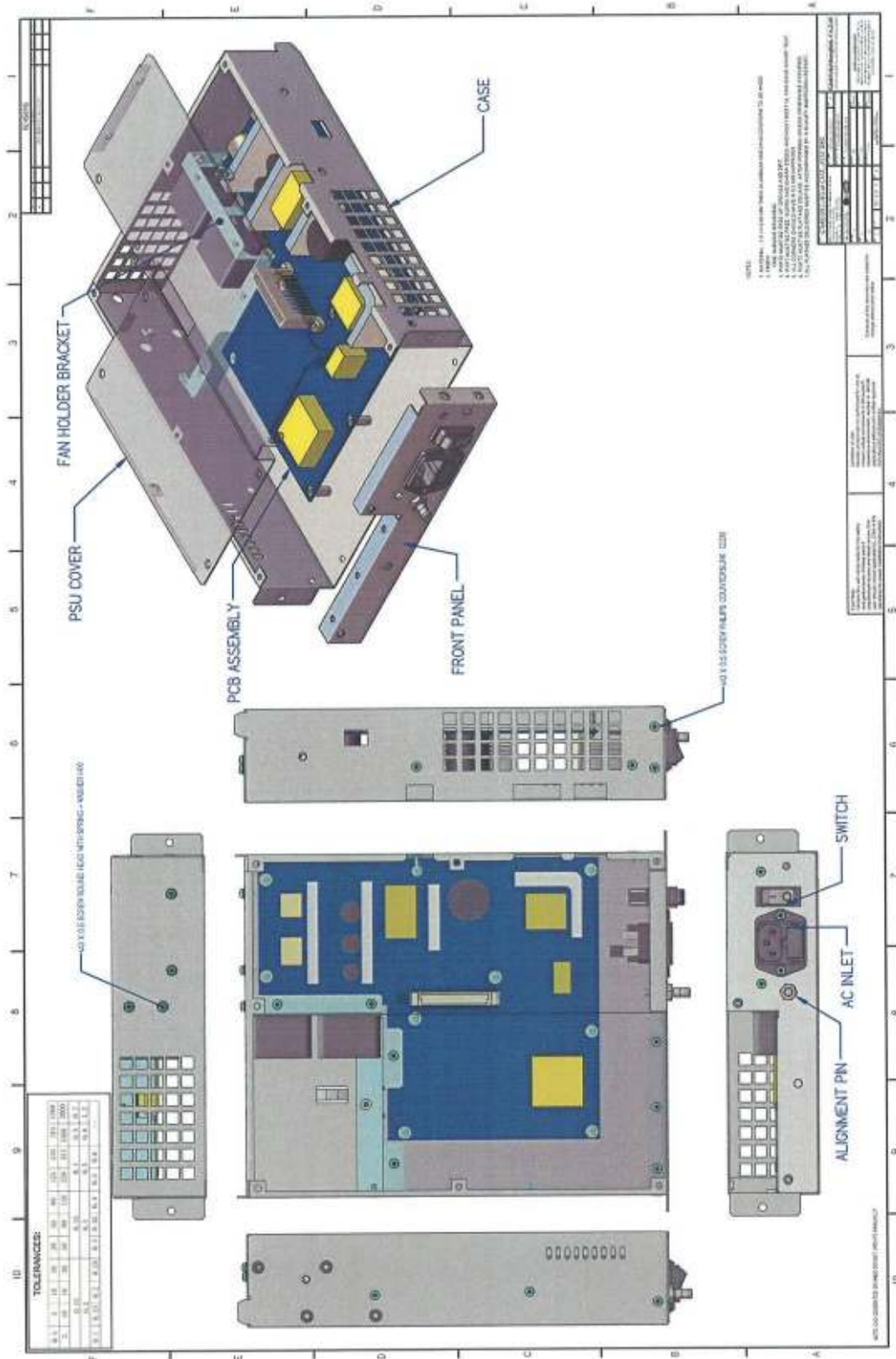

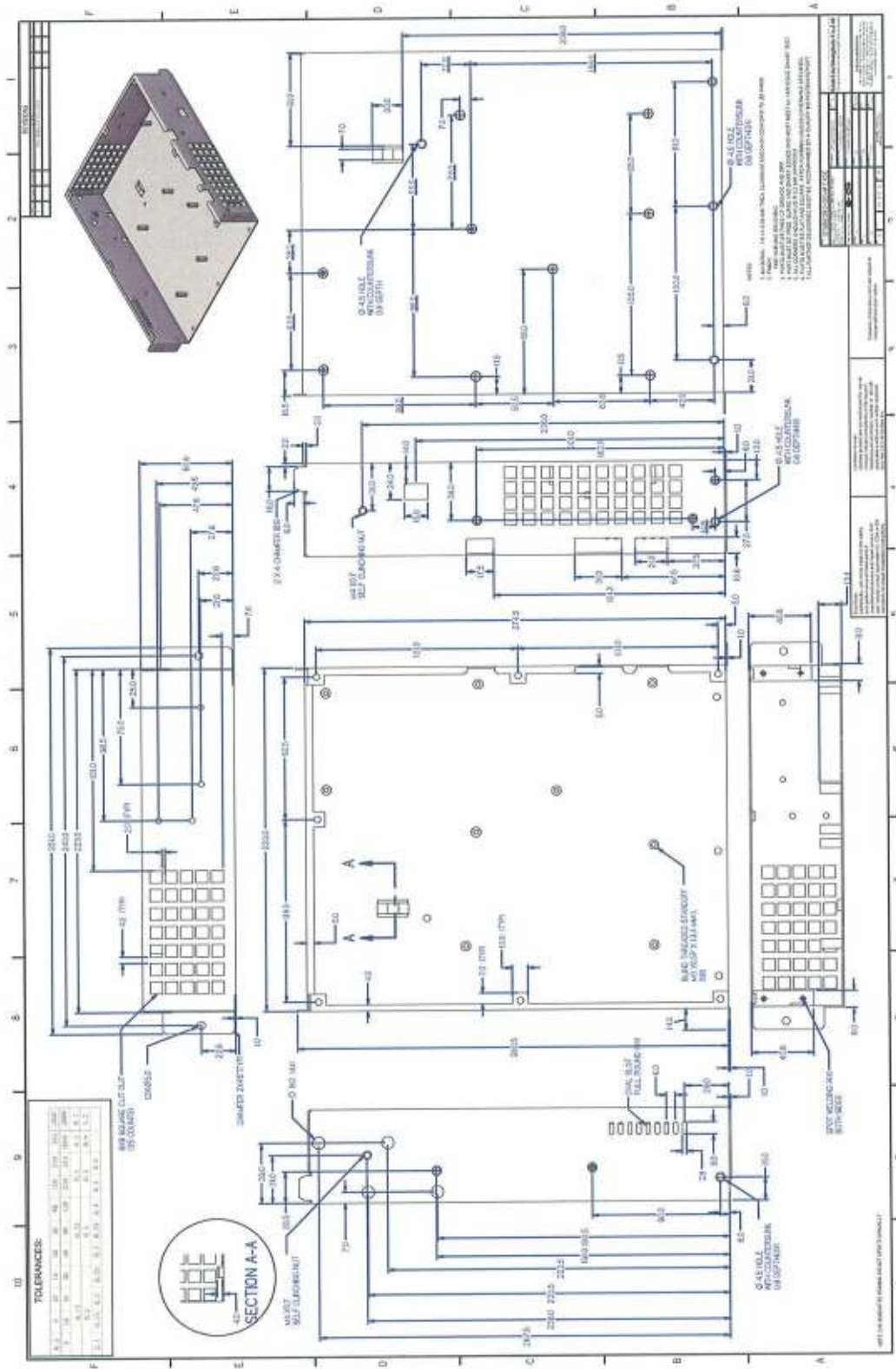

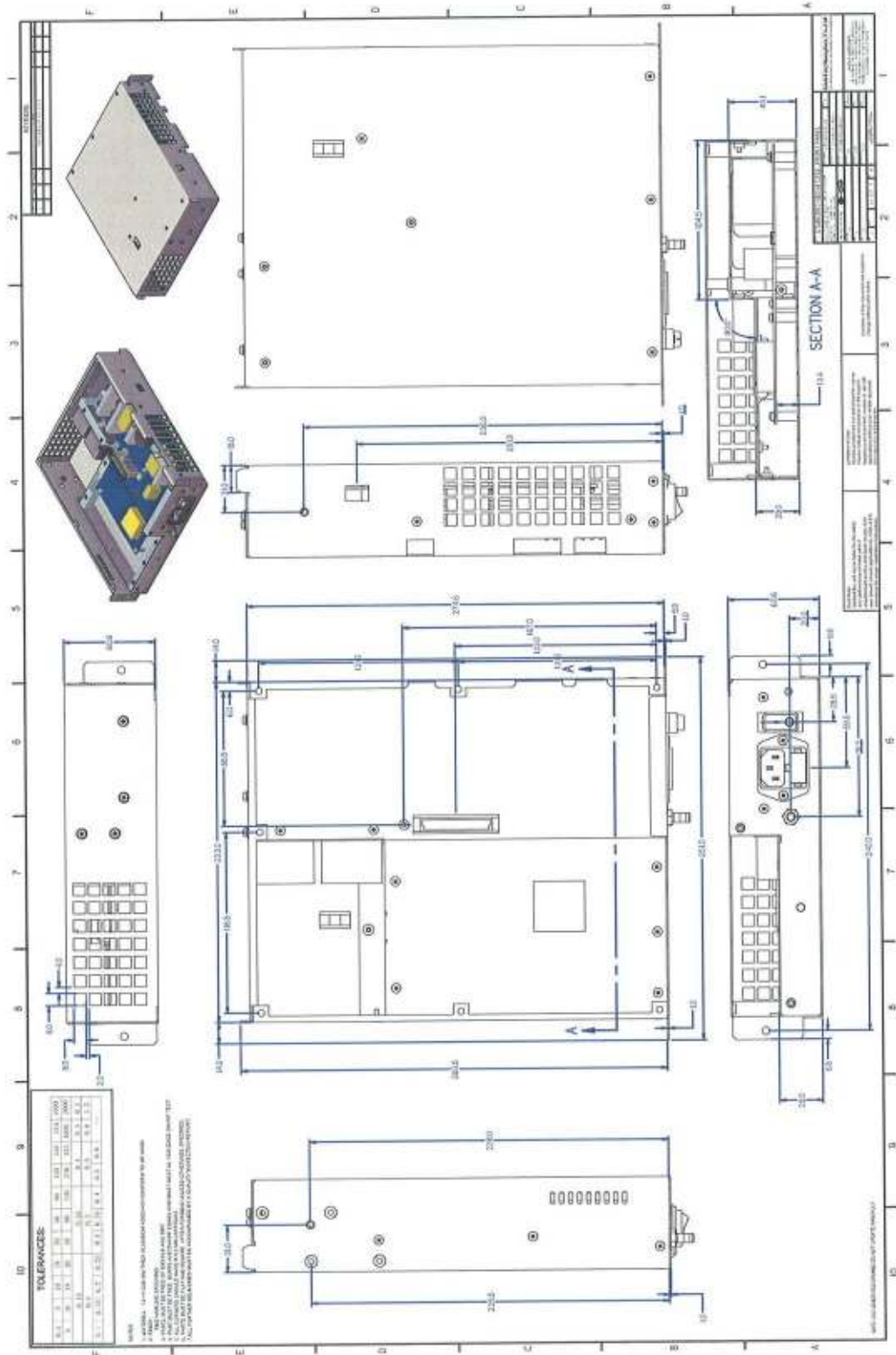

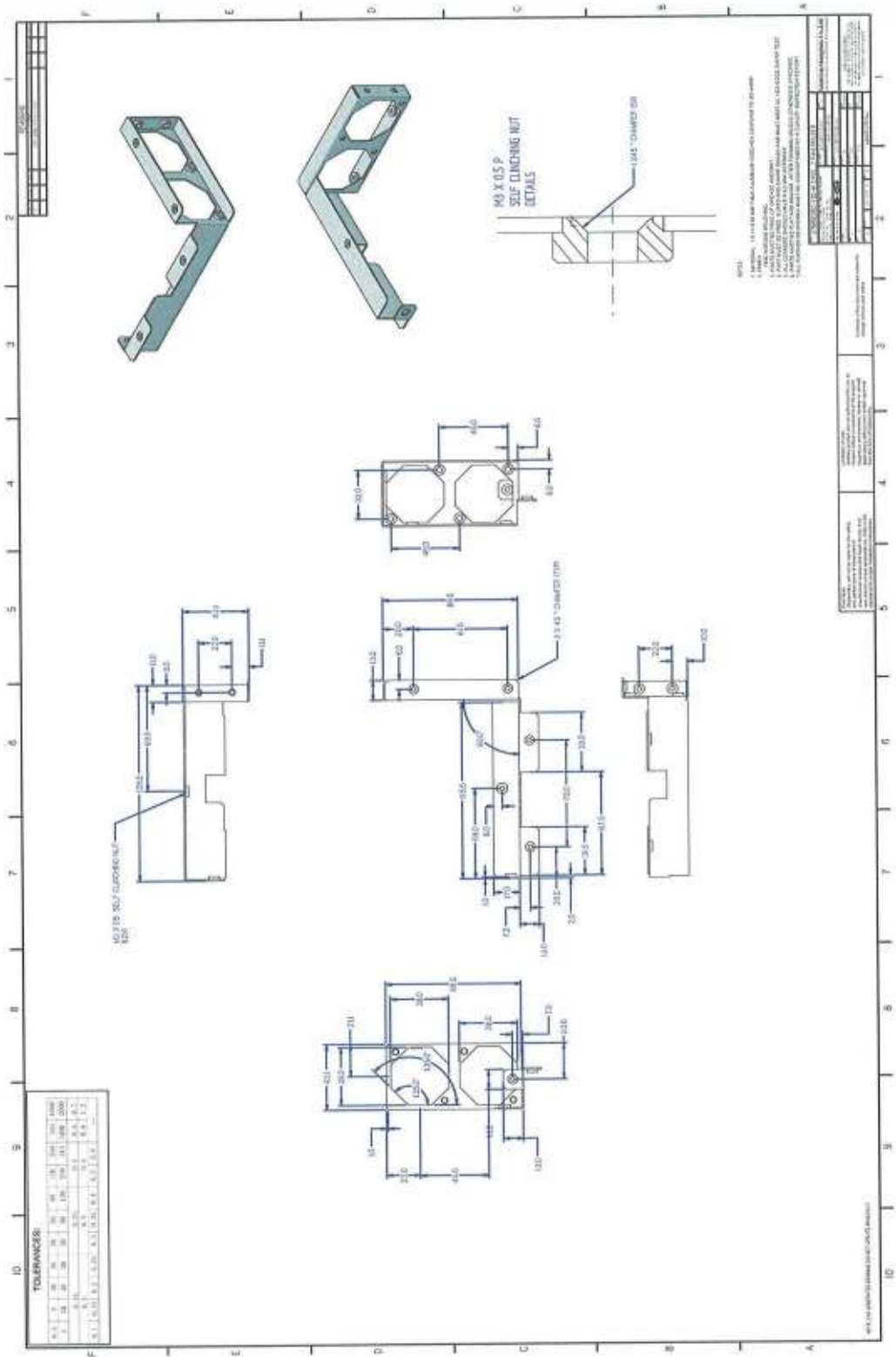

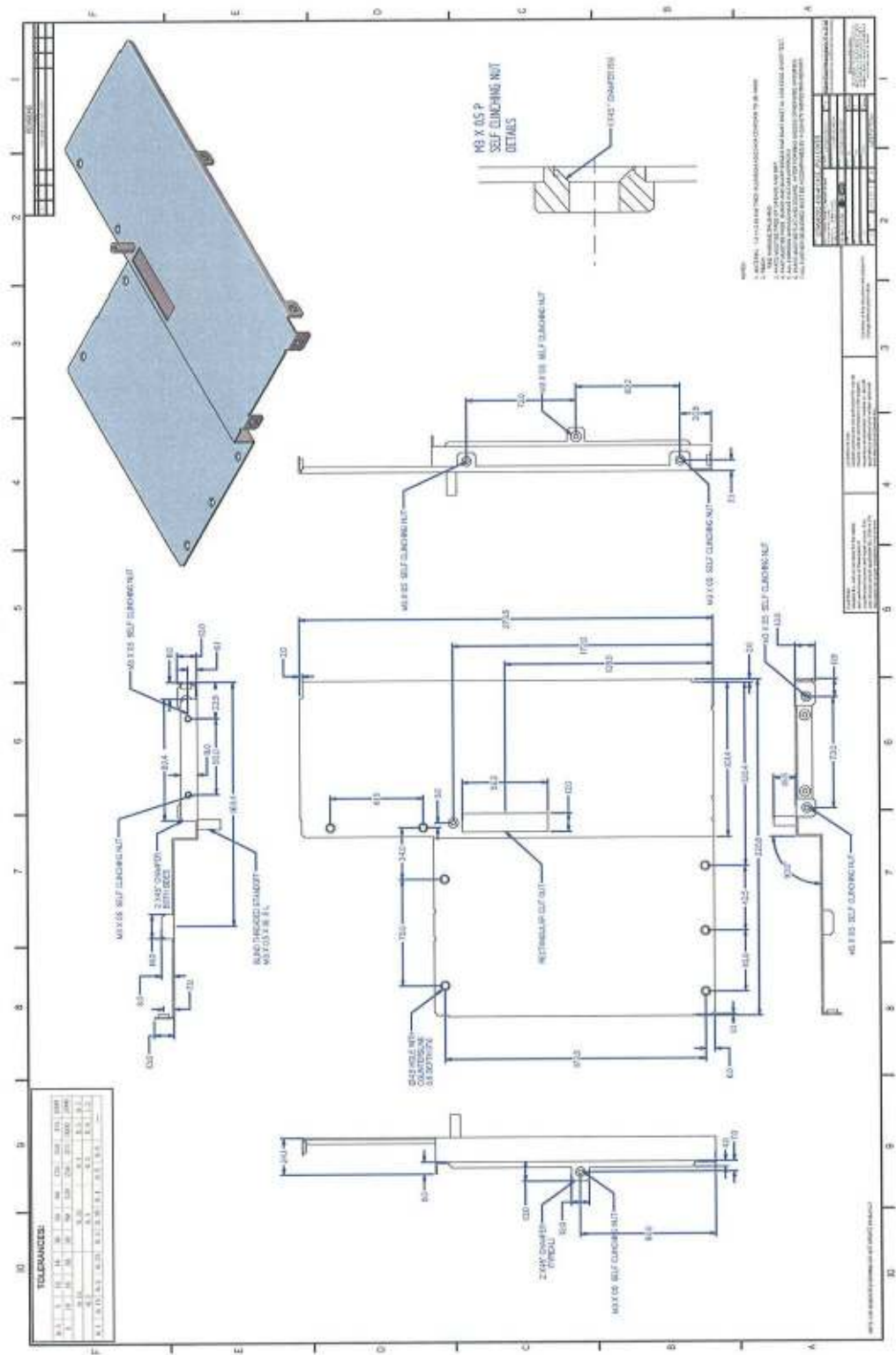

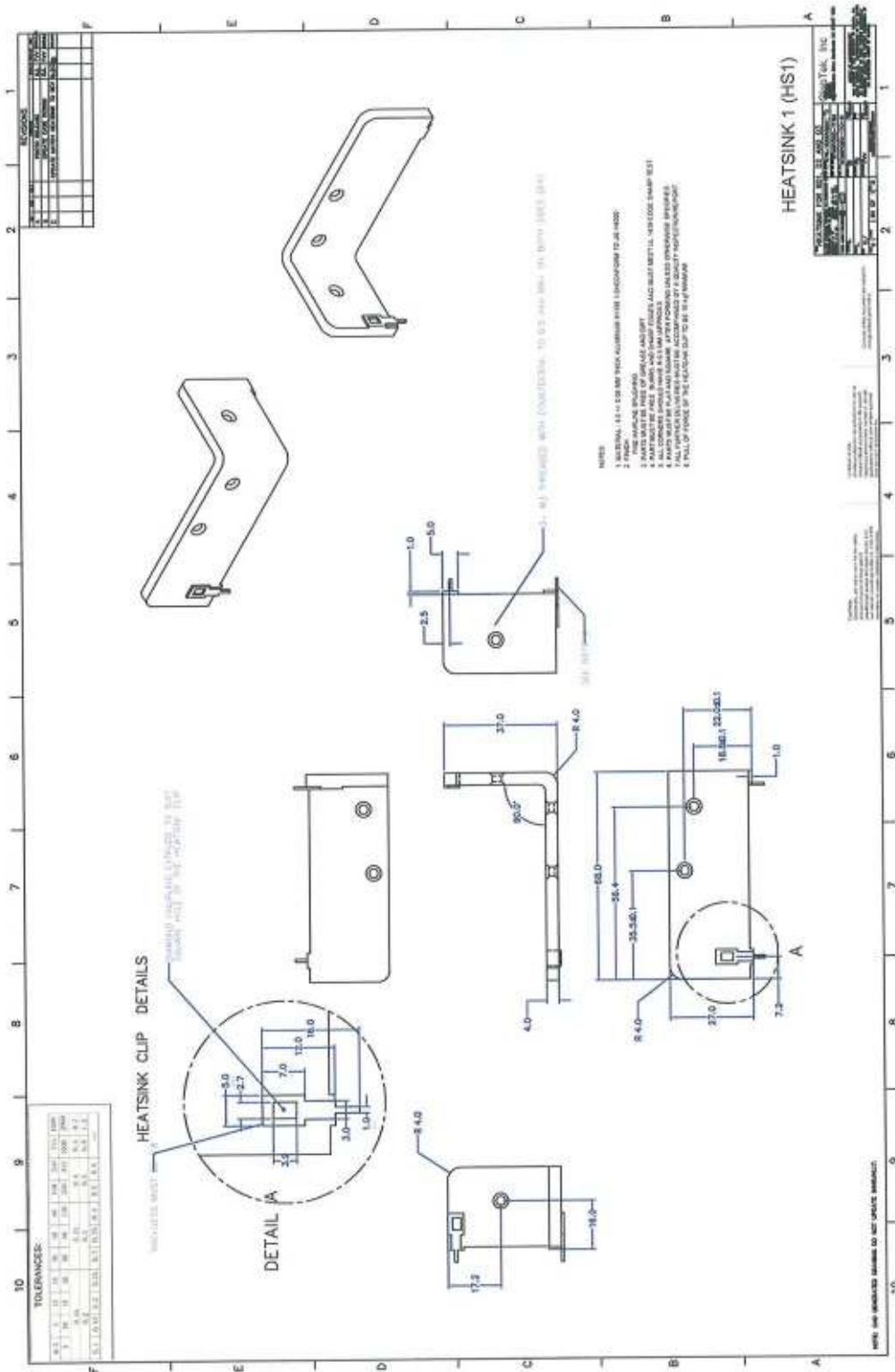

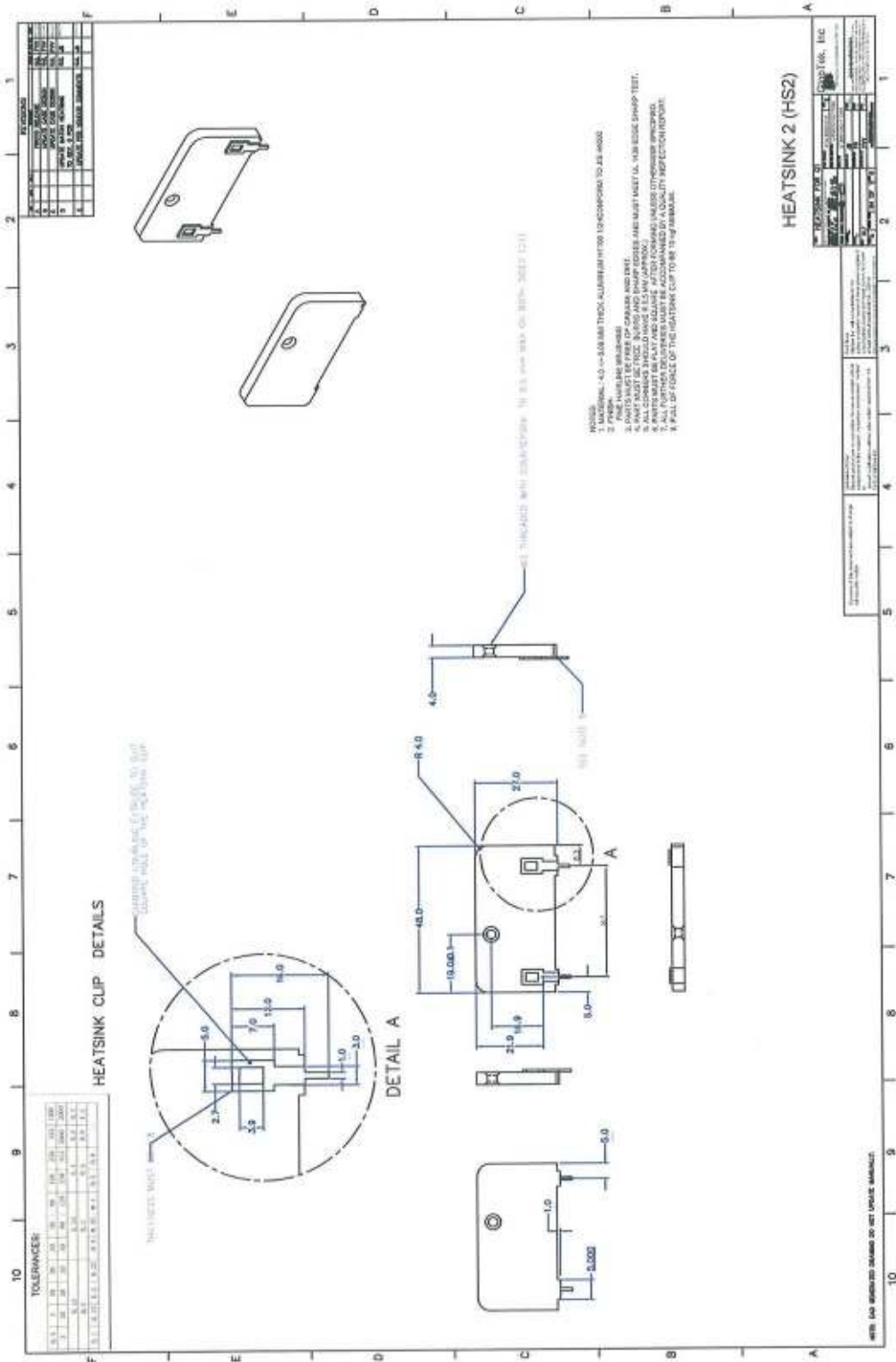

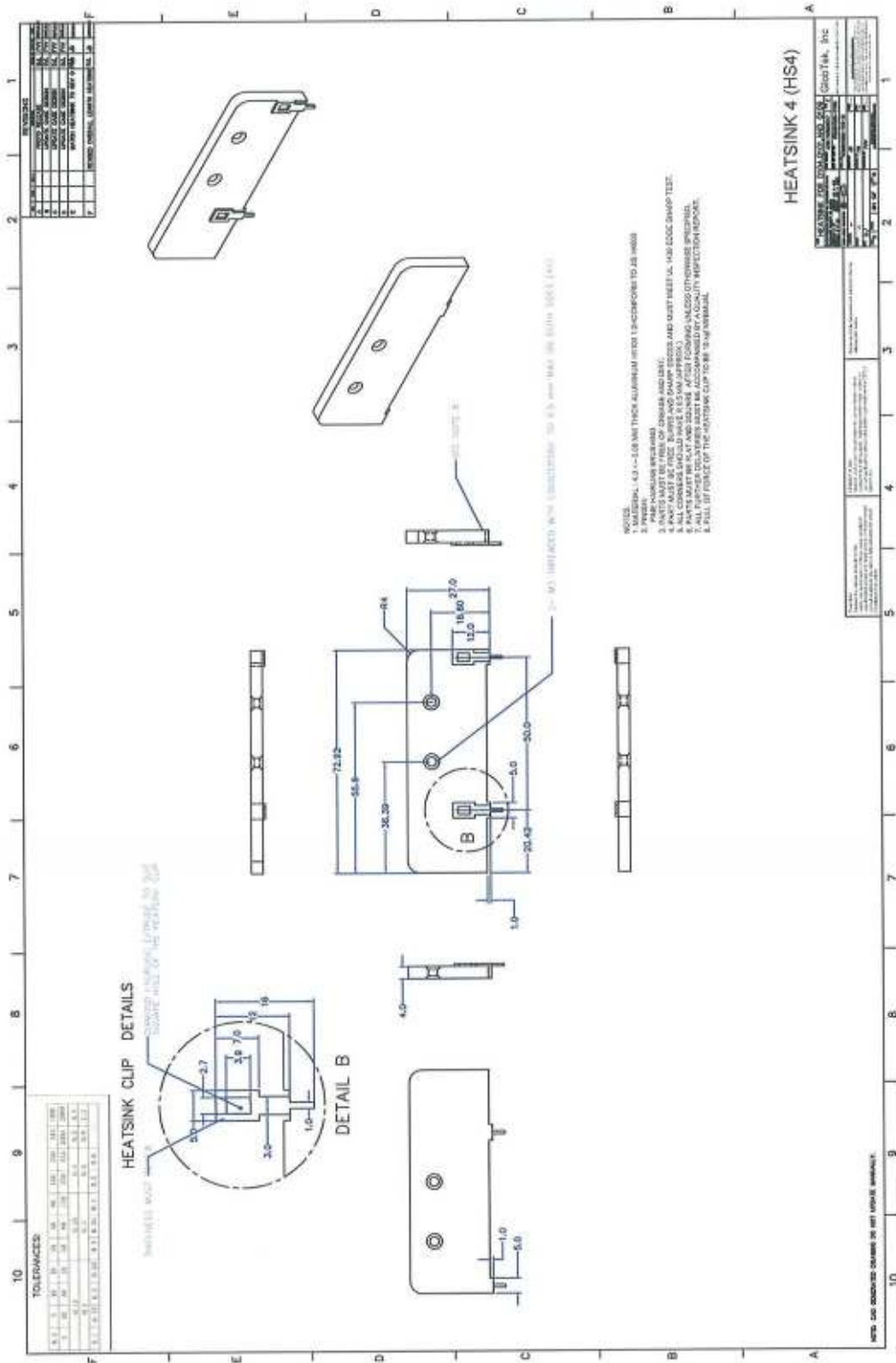

GlobTek Inc.
GTM91092-110-M
POB, Rev. H
Top side copper

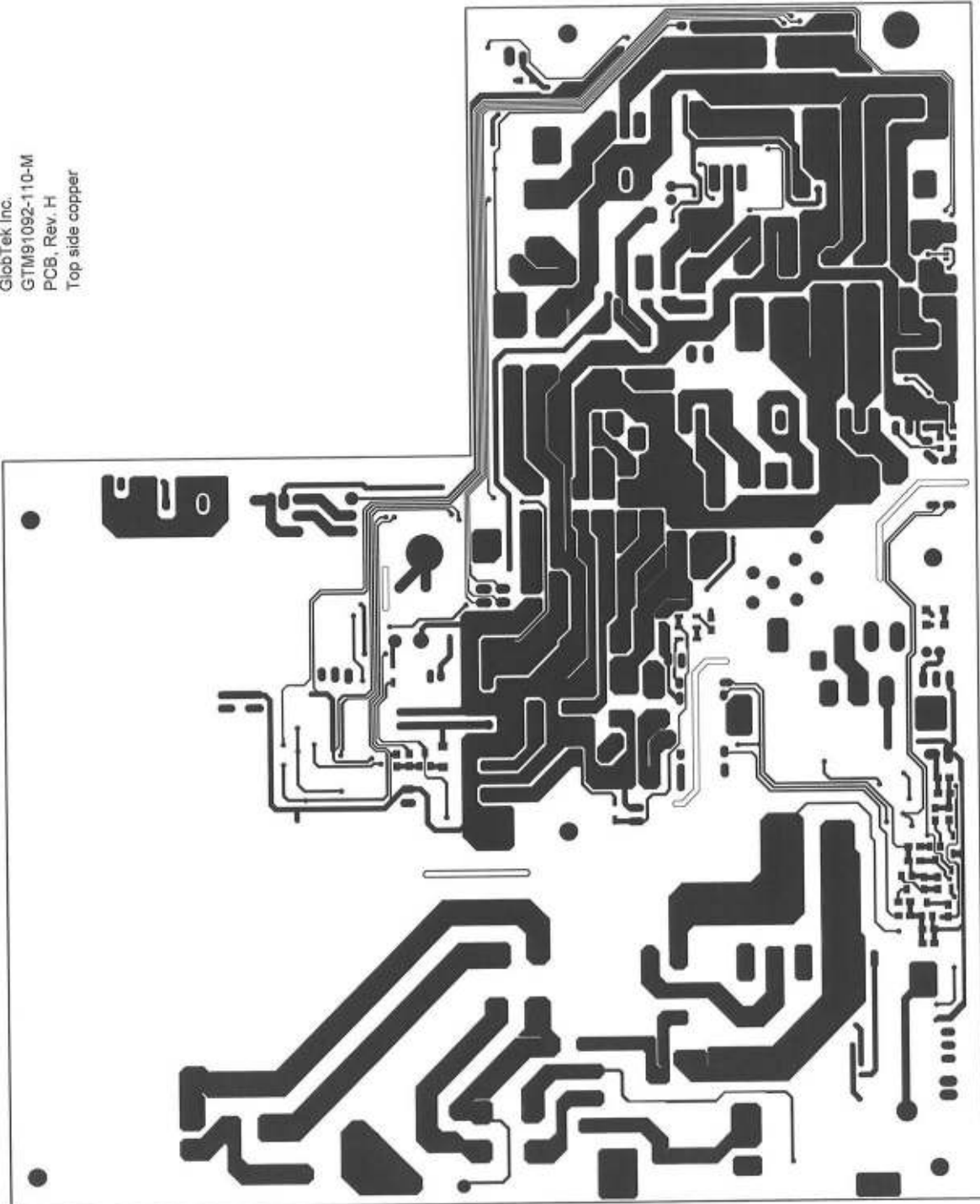

GlobTek Inc.
GTM91092-110-M
PCB, Rev. H
Bottom side copper

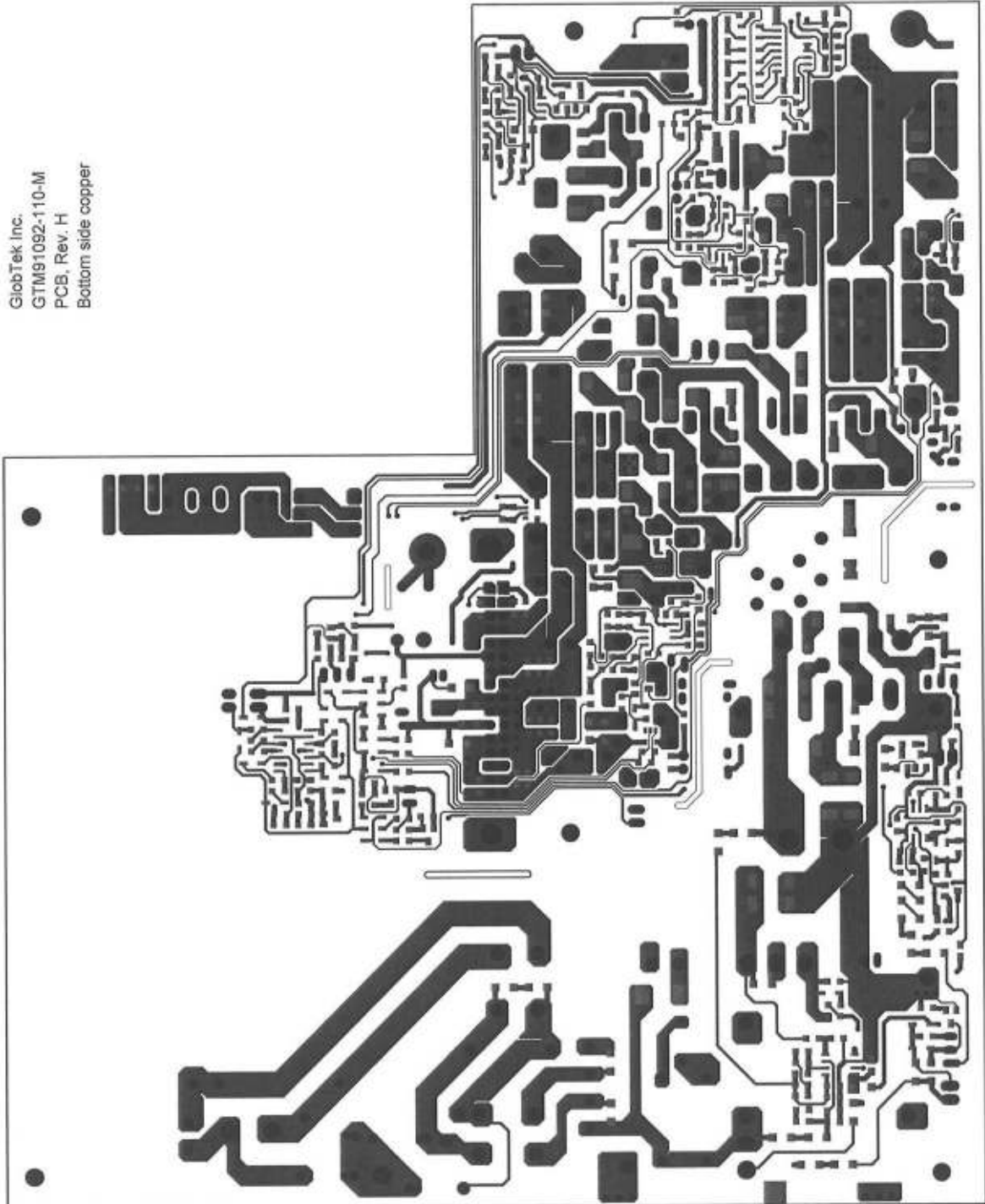

GlobTek Inc.
GTM91092-110-M
PCB, Rev. H
Top side silk screen

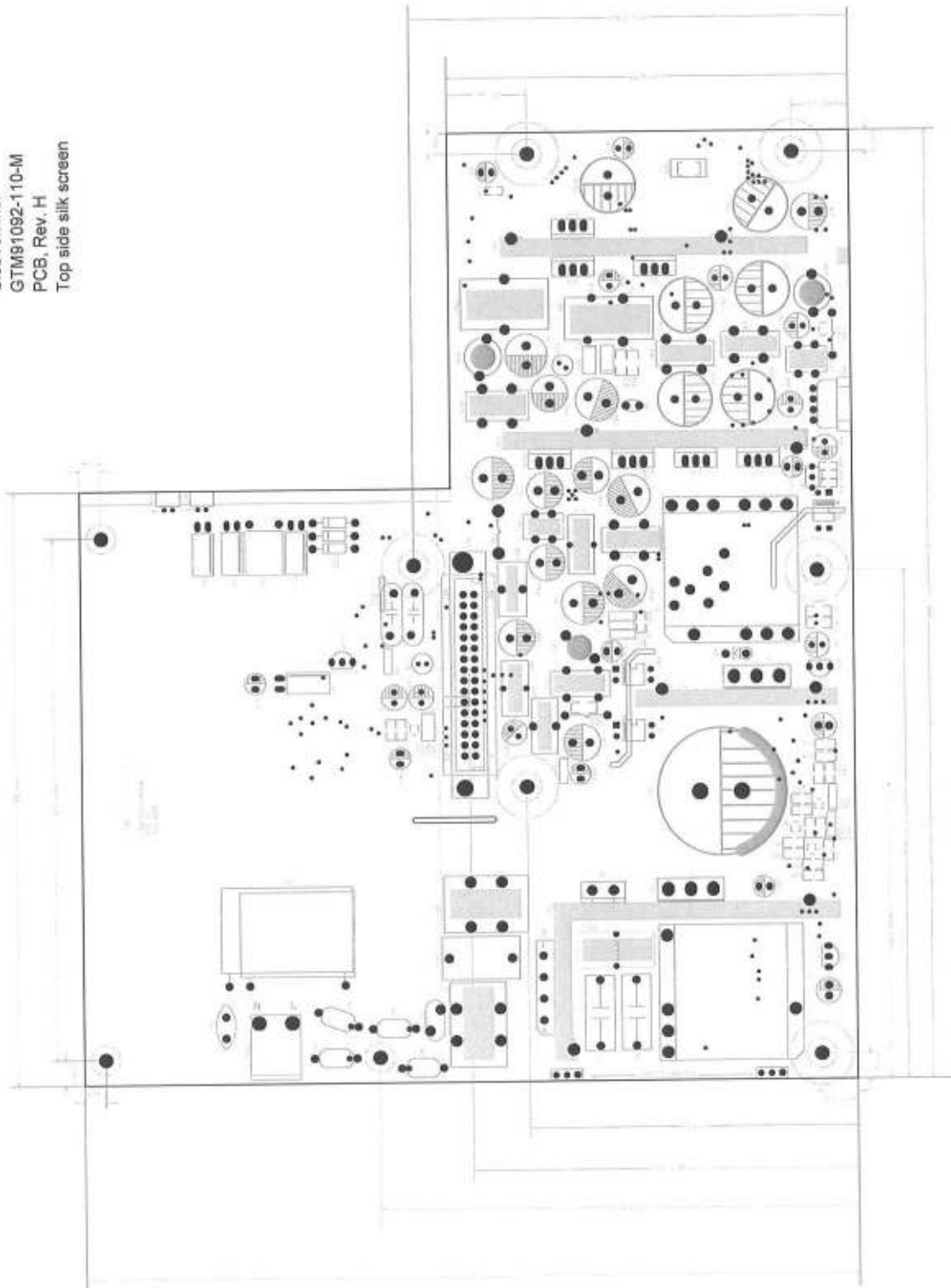

GlobTek Inc.
GTM91092-110-M
PCB, Rev H
Bottom side silk screen

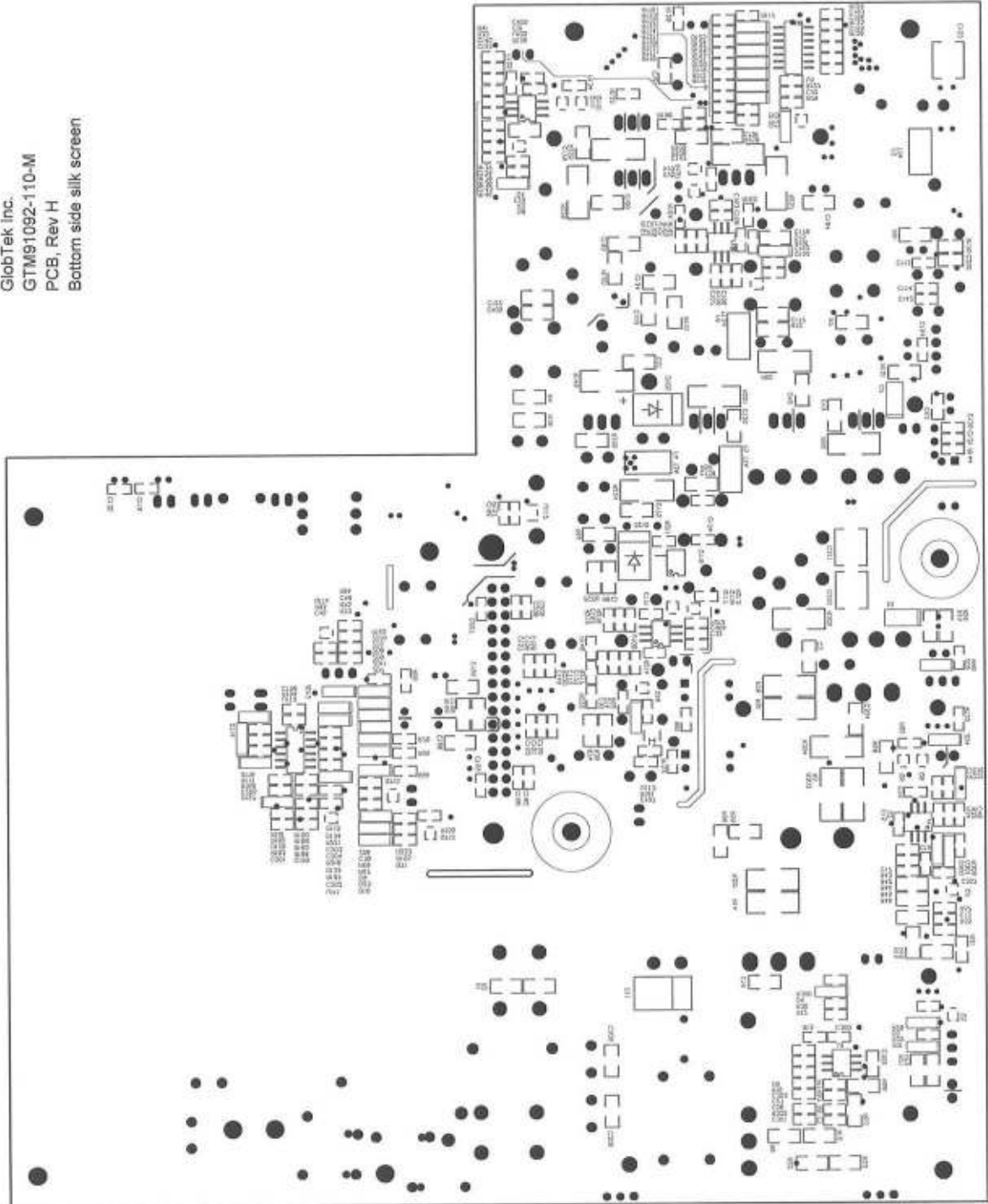

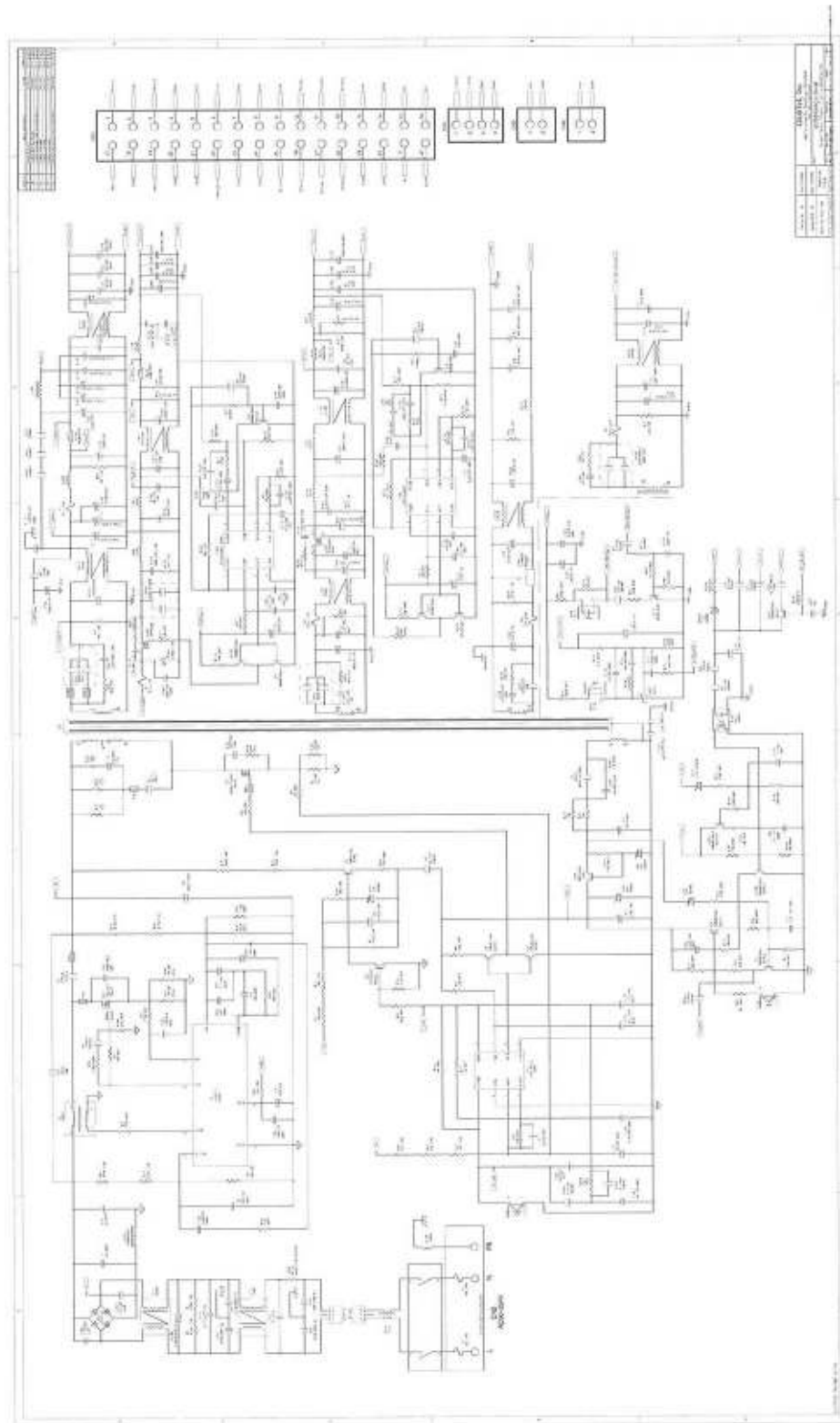

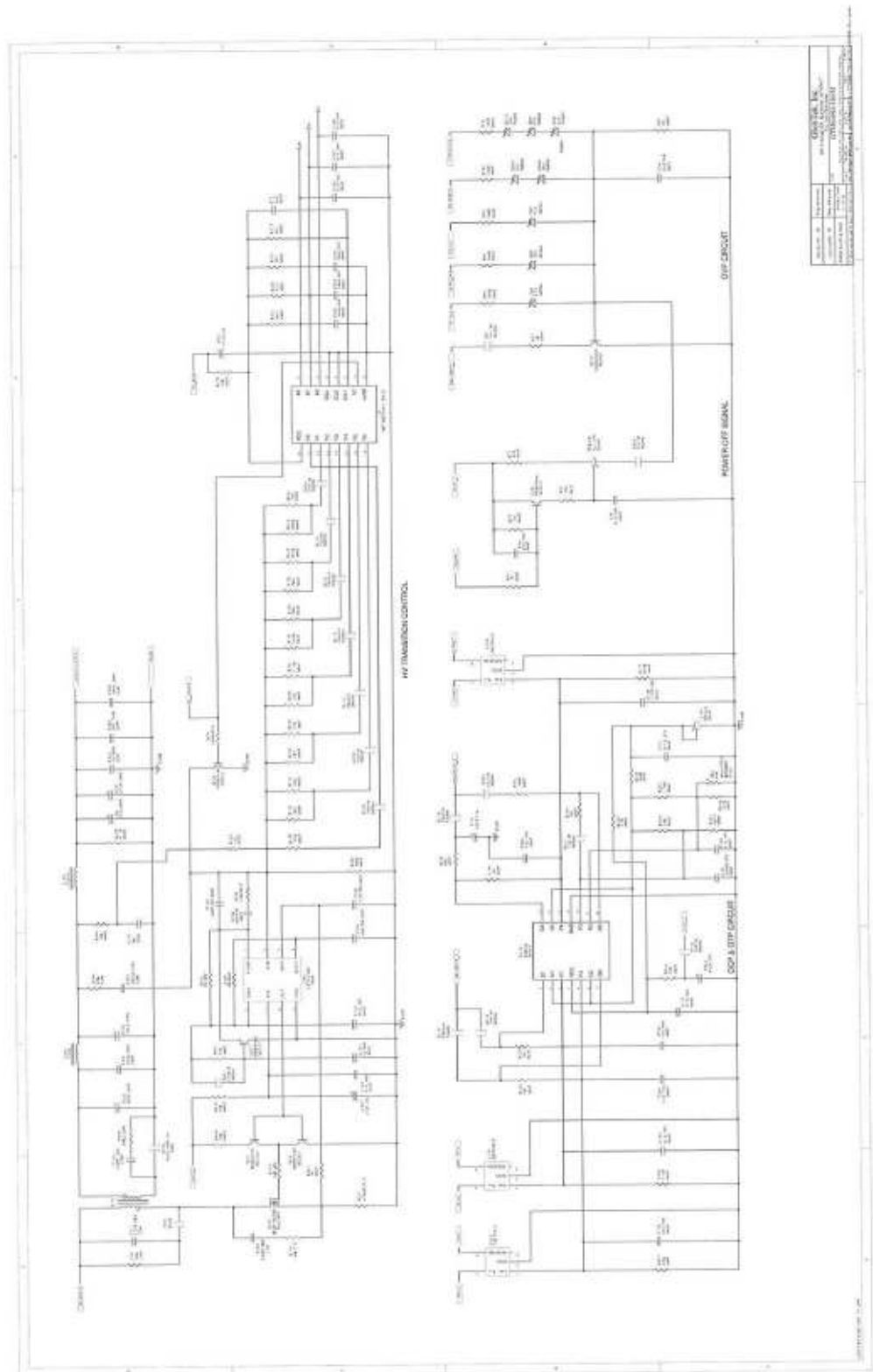

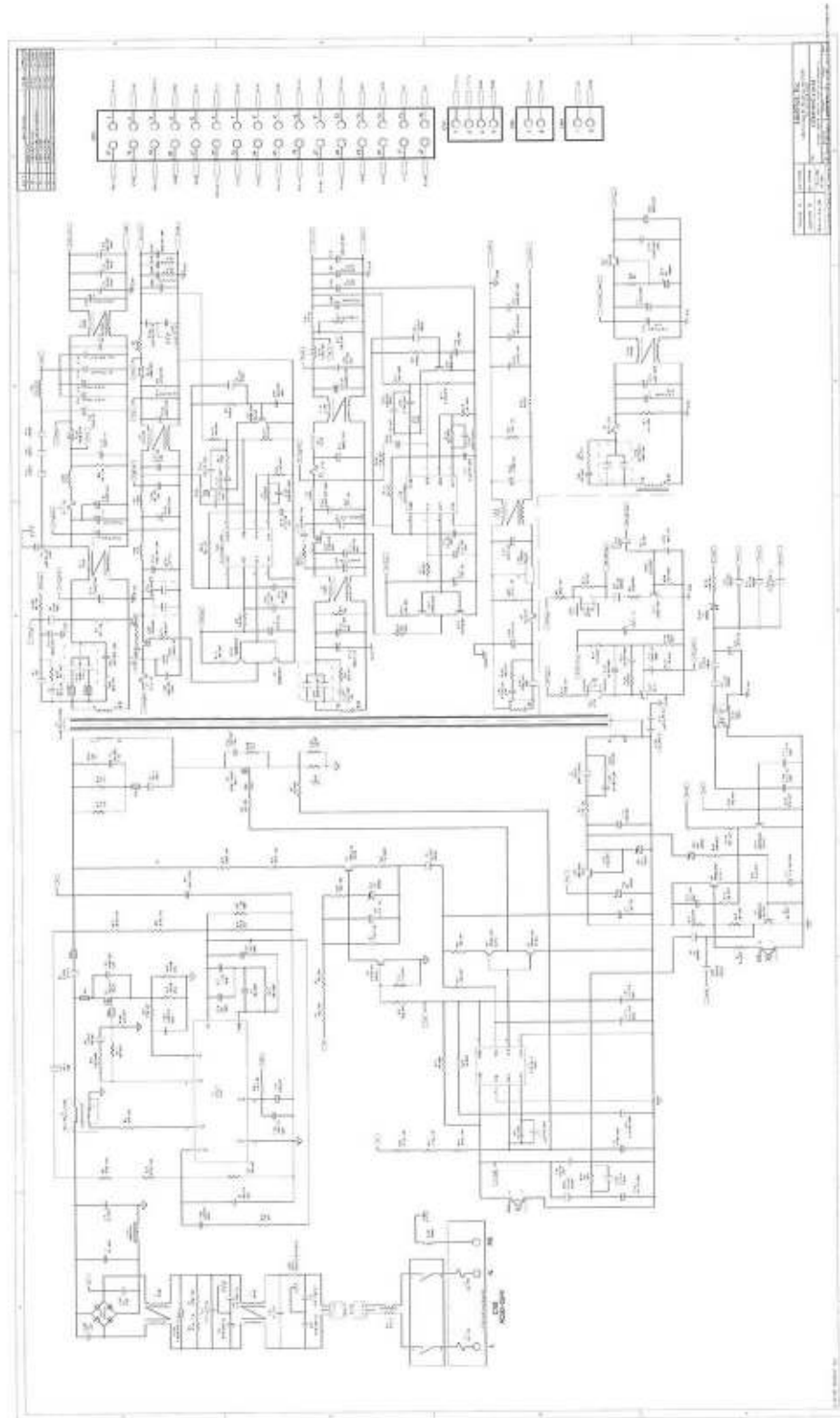

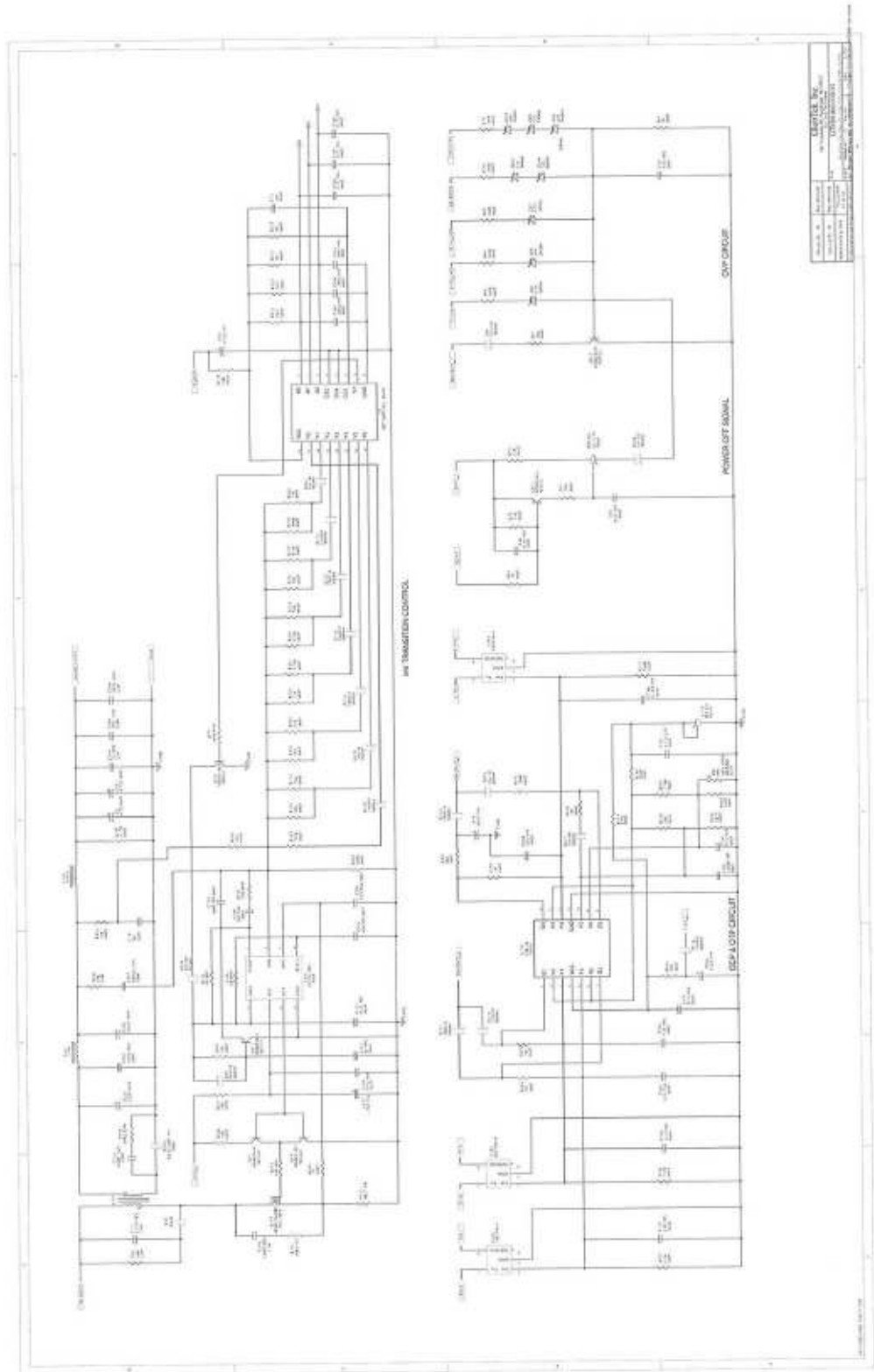

GTM91092-110-M
Bottom Side of PCB

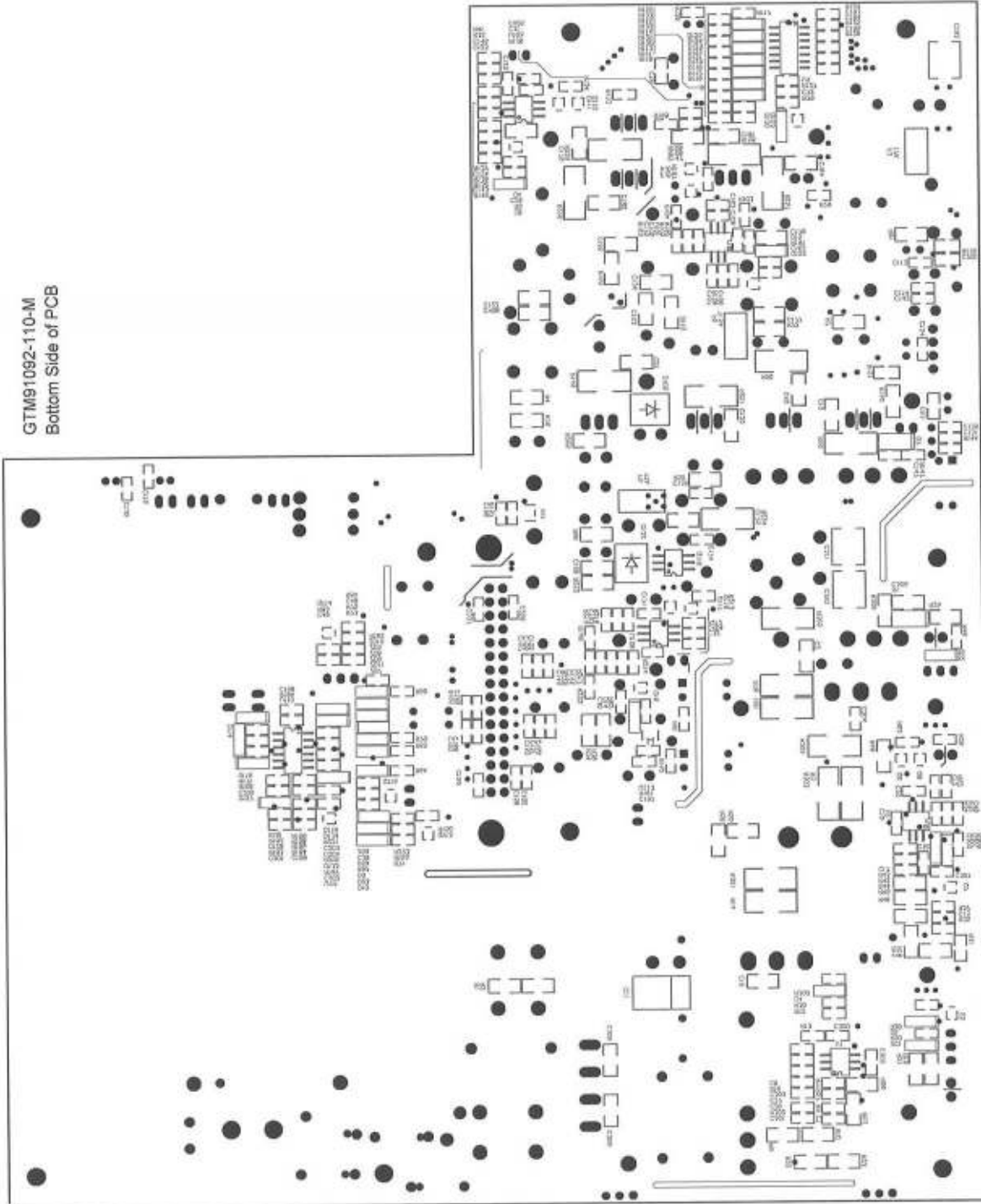

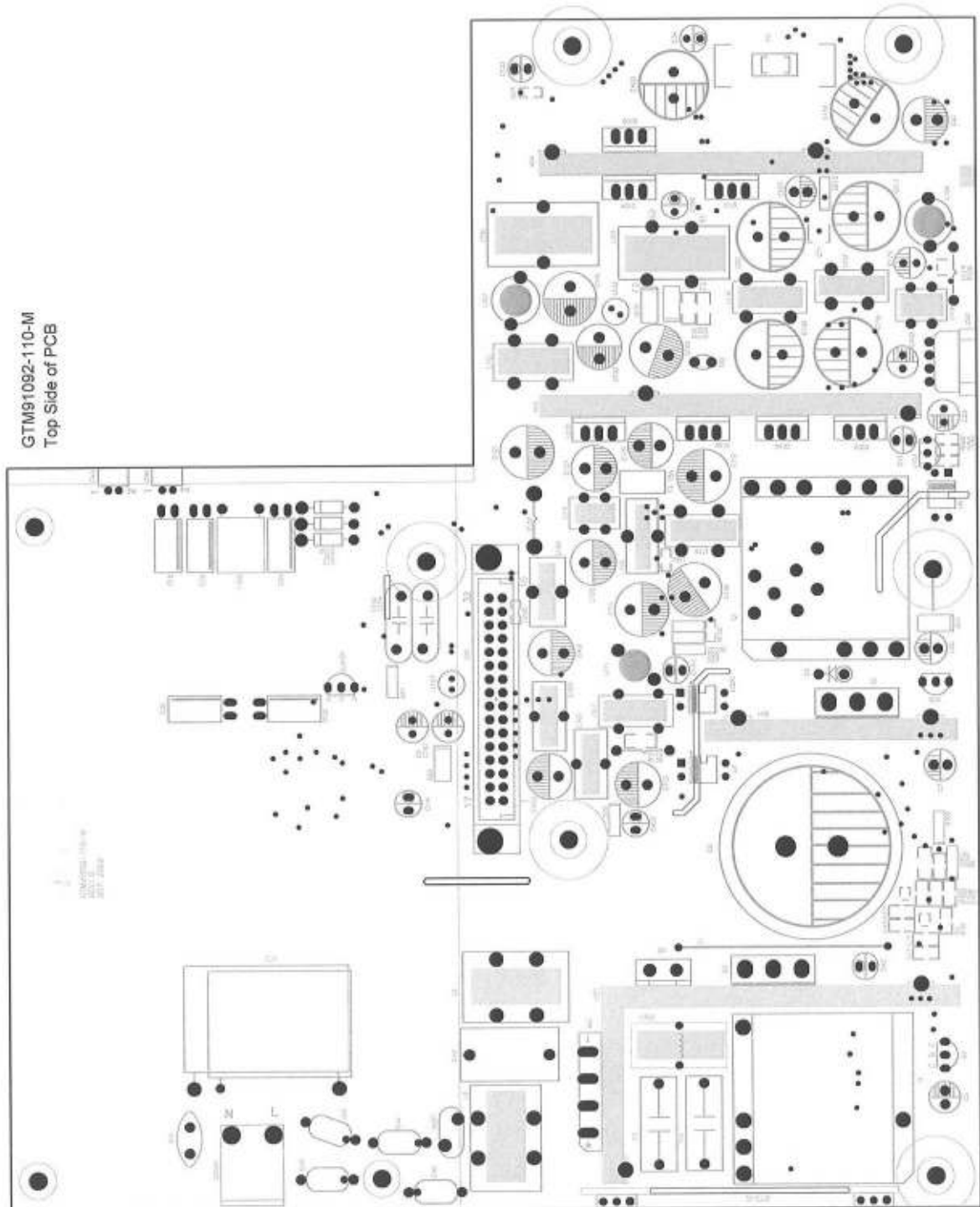

APPROVED
By Jayson B. at 2:47 pm, 11/17/08

所有数据属：GlobTek 公司，任何复制和部分的复制都是非法的，除非取得
本文件所有者的书面许可。
PROPRIETARY INFORMATION
PROPRIETARY OF GLOBTEK, INC. ANY REPRODUCTION, DISCLOSURE
OR USE OF THIS DRAWING IN WHOLE OR PART, IS HEREBY
PROHIBITED EXCEPT AS SPECIFIED IN WRITING BY GLOBTEK, INC.

REV 版本 A	REVISION 修订本 DESCRIPTION 描述 INITIAL RELEASE 初始版本	DATE 日期 2008.11.07	APPROVED 批准 RYAN
-------------	--	-----------------------	---------------------

1. MECHANICAL ASSEMBLY: (UNIT) :mm
机构组装图:(单位):mm

2. SCHEMATIC:
线路图

NOTE:
1. 绕线均匀平整
THE WINDING SHOULD BE EVEN
2. 成品底部需点胶固定(共两点)如图示
EPOXY FIXING ON THE BOTTOM AS THE DRAWING (TWO POINT)
3. 成品需含浸
VARNISH REQUIREMENT

NO	START	FINISH	WIRE SIZE	COLOR	TURNS	INDUCTANCE
N1	1	2	0.5mm		34T	80uH±10%

HI-POT TEST:AC 50Hz/5mA
APPLY 5000VDC COIL - COIL AND COIL - CORE FOR 60 SEC

NO	NAME	MATERIAL	SUPPLIER	UL NO	CLASS
1	WIRE	EPDM WIRE	PACIFIC TONTRONIC WIRE & CABLE CO., LTD	E201757	155° C
2	CORE	CS127125			
3	TUBE	UL TUBE	DONGGUAN QUNTAI ELECTRONICS CO., LTD	E227336	125° C
4	EPOXY	G 8500A/B	GUBAK CHEMISTRY TECH.(KANGSILAN) LTD.	E216733	130° C
5	VARNISH	W-2952F-26 (Y)	HITACHI CHEMICAL CO LTD	F72979	130° C

附注:
GlobTek 公司不对本数据表提供或用于任何非预期用途
而引发的安全和性能问题，特别对于必须遵守
UL、CSA 标准而制定产品的应用。
Foot Note:
GlobTek Inc. will not be liable for the safety
and performance of these parts if used in
any application not intended by the manufacturer.
user should consult applicable UL, CSA or EN
standards for proper installation instructions

说明:
GlobTek 产品及材料不得用于任何非预期用途中
以及任何可能涉及人身伤害或财产损失的应用。
GlobTek 产品不得用于任何可能涉及人身伤害或财产损失的应用。
Limitation of Use:
GlobTek products are not authorized for use as
components in applications where failure could result in
hazardous environment, nuclear or aircraft
applications without prior written approval
from the CEO of GlobTek Inc.

DASH NO.注册号	PART NO 零件号	REV.版本	DESCRIPTION 描述	NOTES备注
-------------	-------------	--------	----------------	---------

WHERE USED 用处: GTM91092-110M
LOCATION 位置: GTS

INIT BY: 申请人: DATE: 2008.11.07
DATE: 日期: 2008.11.07
DRAWN: 制图: G.L
DATE: 2008.11.07
APPROVED: 批准: RYAN
DATE: 2008.11.07

TOLERANCES 公差:	DECIMALS 小数:	ANGULAR 角度:	HILLI METERS 毫米:	GLOBTEK (SUZHOU), CO., LTD Tel: +86-21-6916-0033 Fax: +86-21-6916-0422 Web: www.globtek.com
----------------	--------------	-------------	------------------	--

DWG Title图纸标题:
80uH 3A Buck Choke for GTM91092-110-M.L110

MODEL NO 型号: GTM91092-110M	PART NO 零件号: 321-1001014(R)	REV.版本: A	SCALE 比例: 1:1 SHEET 1 OF 1
-------------------------------	--------------------------------	--------------	-------------------------------

所有数据属 GLOBTEK 公司, 任何整体或部分的复制或翻印都是非法的, 除本取得
 书面授权外, 本图档不得作其他任何用途。
 ALL INFORMATION IS PROPRIETARY TO GLOBTEK INC. ANY REPRODUCTION, DISSEMINATION, OR USE OF THIS DRAWING IN WHOLE OR PART IS HEREBY PROHIBITED EXCEPT AS SPECIFIED IN WRITING BY GLOBTEK, INC.

REV. 版本	REVISION	修订本	DATE / 日期	APPROVED / 批准
A	INITIAL RELEASE	初始版本	2008.11.10	RYAN

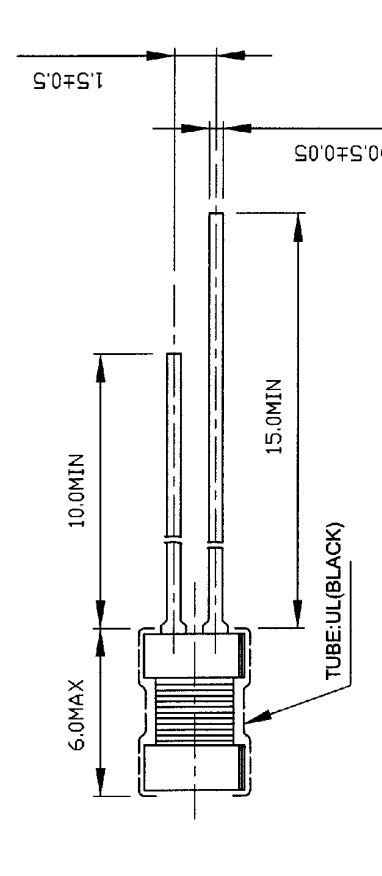
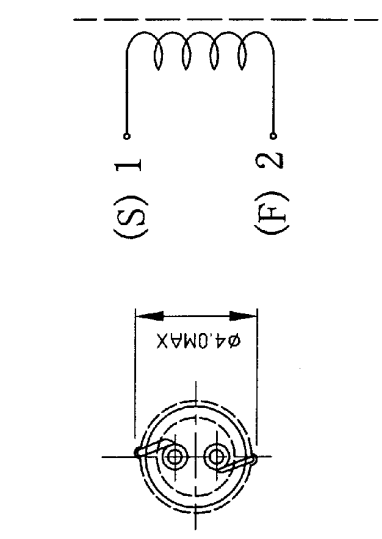

NO	START	FINISH	WIRE SIZE	COLOR	COLOR	TURNS	INDUCTANCE
N1	1	2	∅ 0.11mm		47.7±1		27 μ H ± 10%

APPLY 500VDC COIL - COIL AND COIL - CORE FOR 60 SEC

NO	PARTS	MATERIAL	MANUFACTURER	UL CLASS	UL FRM	COUNTRY OF ORIGIN	TEMP. CLASS
1	WIRE	POLYETHYLENE ENAMELED WIRE OR EQUIVALENT	PACIFIC RAIL ELECTRIC WIRE & CABLE CO., LTD.	EW4108	NA	HULLAND	130° C
2	CORE	WAXES USE 250C OR EQUIVALENT	ZHEJIANG WIRE CO., LTD.	E174837	NA	CHIN(TW)	130° C
3	TUBE	HEAT SHRINKABLE UL EPOXY RESIN(EP-350) OR EQUIVALENT	ZHONGSHAN TONTOUCH PREPRINT PRODUCTS CO., LTD.	E197768	NA	CHIN	130° C
4	ADHESIVE	TUBING OR EQUIVALENT	CHONGKUAN ELECTRONICS(SHENZHEN) CO., LTD.	E180808	NA	CHIN	125° C
5	SOLDER OR EQUIVALENT	S:69, 3-C:26, 7	JIANG SU CHANG FENG CO., LTD.		NA	CHIN	NA
6	LEAD PIN	SOLDER RELATED COPPER WIRE OR EQUIVALENT	ALPHA METALS LTD.		NA	USA	NA

备注: Globtek 公司不对本图档所标注的自给零件或组件的规格负责, 且不承担任何责任, 但用户必须遵守 US, CSA 或 IEC 标准中规定的安装要求。
 Note: Globtek Inc. will not be liable for the safety and performance of these parts if user should consult applicable UL, CSA or IEC standards for proper installation instructions.

WHERE USED / 应用:	GTM91092-110M
LOCATION / 位置:	GTS
INT BY / 制图人:	G.L.
DATE / 日期:	2008.11.10
DRAWN / 绘图:	G.L.
APPROVED / 批准:	RYAN
DATE / 日期:	2008.11.10

DASH NO / 注册号	PART NO / 零件号	REV / 版本	DESCRIPTION / 描述	NOTES / 备注

GlobTek(Shanghai), Co., Ltd
 Tel: +86-21-5016-8033 Fax: +86-21-5016-9422 Web: www.globtek.cn
 Drawing Title / 图纸标题:
 27uH 200mA Choke for GTM91092-110M.L1102

TOLERANCES / 公差:
 ANGULAR: XX ± 0.1°
 MILLIMETERS: XX ± 0.05
 ANGMETERS: XX ± 0.03

SIZE / 尺寸:
 MODEL NO / 型号: GTM91092-110M
 PART NO / 零件号: 321-1000102R
 SCALE / 比例: 5:1

SHEET 1 OF 1

APPROVED
By Jayson B. at 3:08 pm, 1/17/08

REVISION 修正本
DESCRIPTION 描述
INITIAL RELEASE 初始版本

REV 版本
A

DATE 日期
2008.11.07

APPROVED 批准
RYAN

NOTE:
1. 绕线均匀平整
THE WINDING SHOULD BE EVEN
2. 成品底部两侧需点黑胶固定 (共两点) 如图所示
EPOXY FIXING ON THE BOTTOM AS THE DRAWING (TWO POINT)
3. 成品需涂漆
VARNISH REQUIREMENT

APPLY 500VDC COIL - COIL AND COIL - CORE FOR 60 SEC

NO	START	FINISH	WIRE SIZE	COLOR	TURNS	INDUCTANCE	UL NO	UL CLASS	TEMP CLASS	COUNTRY OF ORIGIN
1	1	2	Ø0.11mm		155±1	280µH±10%	E142108	NA	130° C	THAILAND
							E174837	NA	130° C	CHINA(TW)
							E197768	NA	130° C	CHINA
2							NA	NA	NA	CHINA
3							E180908	NA	125° C	CHINA
4							NA	NA	NA	CHINA
5							NA	NA	NA	CHINA
6							NA	NA	NA	CHINA

WHERE USED/用途: GTM91092-110M

LOCATION/区域: GTS

INIT. BY: 申请人
日期: 2008.11.07

DRAWN: G.L.
日期: 2008.11.07

APPROVED: RYAN
日期: 2008.11.07

批准

TELENCANCES/公差:

DECIMALS	ANGULAR
XXX ± .1	ANGULAR ± 1
XXX ± .03	ANGULAR ± .1
XXX ± .03	ANGULAR ± .1
XXX ± .03	ANGULAR ± .1

DATE: 2008.11.07
DATE: 2008.11.07
DATE: 2008.11.07

尺寸: A4
尺寸: A4
尺寸: A4

SCALE 比例: 5:1

文件内容若有允许不得更改

警告: 产品未获批准不得使用于航空设备中
除非有GLOBTEK公司书面授权的许可书, 否则不得更改。
Globtek products are not authorized for use as critical components in life support, hazardous environment, nuclear or aircraft applications without written approval from the CEO of Globtek Inc.

注意: 本公司产品禁止用于航空设备, 除非有GLOBTEK公司书面授权的许可书, 否则不得使用。
Globtek Inc. will not be liable for the safety and performance of these parts if used in life support, hazardous environment, nuclear or aircraft applications without written approval from the CEO of Globtek Inc.

REVISION 修正本
DESCRIPTION 描述
INITIAL RELEASE 初始版本

REV 版本
A

DATE 日期
2008.11.07

APPROVED 批准
RYAN

REVISION 修订本 DESCRIPTION 描述 RELEASE FOR PILOT PRODUCTION		DATE 日期 2008.11.10	APPROVED 批准 RYAN
REV	A		

所有数据属 Globtek 公司，任何团体和个人均不得复制或再行传播，一经发现，除采取法律行动外，Globtek 公司保留追究法律责任的权利。
 ALL DATA BELONGS TO GLOBTEK, INC. ANY REPRODUCTION, DISCLOSURE OR USE OF THIS DRAWING IN WHOLE OR PART, IS HEREBY PROHIBITED EXCEPT AS SPECIFIED IN WRITING BY GLOBTEK, INC.

1. MECHANICAL ASSEMBLY: (UNIT) :mm
机构组装图: (单位) :mm

NOTE:
1. 绕线均匀平整
THE WINDING SHOULD BE EVEN

2. ELECTRONICS WIRE&TURNS: AT 1KHz / 0.25V (CHEN HWA CH100)

NO	START	FINISH	WIRE SIZE	COLOR	TURNS	INDUCTANCE
N1	1	2	1.0mm		4.5T	0.6uH Min

HI-POT TEST: AC 50Hz/5mA
APPLY 500VDC COIL TO COIL AND COIL TO CORE FOR 60 SEC

NO	NAME	MATERIAL	SUPPLIER	UL NO	CLASS
1	WIRE	IPEW WIRE	PACIFIC TRONTRIC WIRE & CABLE CO., LTD	E201757	155° C
2	CORE	AR6x10			
3	TUBE	UL TUBE	DONGGUAN QUANTAI ELECTRONICS CO., LTD	E227336	125° C
4	EPOXY	G 8500A/B	GUDAK CHEMISTRY TECH (DONGGUAN) LTD.	E216733	130° C
5	VARNISH	WP-2952F-2G (Y)	HITACHI CHEMICAL CO LTD	E72979	130° C
6	HEAT SHRINK TUBING				

SPECIFICATION CONTROL DRAWING

DASH NO	注册号	PART NO 料号	REV. 版本	DESCRIPTION 描述	NOTES 备注
WHERE USED: 用途	GTM91092-10-M				
LOCATION: 区域	GTS				
INIT. BY: 申请者	GL	DATE: 2008.11.10			
DRAWN: 制图	RYAN	DATE: 2008.12.10			
APPROVED: 批准					

GlobTek(Shanghai), Co., Ltd
 Tel: +86-21-6916-0053 Fax: +86-21-6916-0022 Web: www.globtek.cn
 Drawing Title: 图纸标题
 0.6uH 5A Ripple Choke for GTM91092-10-M
 104.L117.L111
 MODEL NO. 料号
 GTM91092-10-M
 PART NO. 零件号
 321-100101(R)
 Rev. 版本
 A

SCALE 比例: 1:1 SHEET 1 OF 1

APPROVED
By Jayson B. at 11:19 pm, 11/10/08

REV. 版本	DESCRIPTION 描述	DATE 日期	APPROVED 批准
A	INITIAL RELEASE 初版	2008.11.10	RYAN

所有数据属 Globtek 公司。任何复制和修改均须经批准。未经授权，Globtek 公司保留此图。任何复制或修改 Globtek 公司之任何数据或图样，或在本图样上作任何复制或修改，或在本图样上作任何复制或修改，或在本图样上作任何复制或修改，均须经 Globtek 公司批准。PROHIBITED EXCEPT AS SPECIFIED IN WRITING BY GLOBTEK, INC.

1. MECHANICAL ASSEMBLY: (UNIT) : mm

机构组装图: (单位) : mm

2. SCHEMATIC: 线路图

NOTE:

1. 绕线均匀平整
THE WINDING SHOULD BE EVEN
2. 成品底部两个固定点需固定（共两点）如图示
EPOXY FIXING ON THE BOTTOM AS THE DRAWING (TWO POINT)
3. 成品需含浸
VARNISH REQUIREMENT

NO	START	FINISH	WIRE SIZE	COLOR	TURNS	INDUCTANCE
N1	1	2	1.1mm		171	25 μ H \pm 10%

HI-POT TEST: AC 50Hz/5mA
APPLY 500VDC COIL - COIL AND COIL - CORE FOR 60 SEC

NO	NAME	MATERIAL	SUPPLIER	UL NO	CLASS
1	WIRE	APEW WIRE	PACIFIC TRONTRIC WIRE & CABLE CO., LTD	E20175	155° C
2	CORE	MICROMETALS T69-25D			
3	TUBE	LL TUBE	DONGGUAN QUANTAT ELECTRONICS CO., LTD	E227336	125° C
4	EPOXY	G 8500A/R	QUAK CHEMISTRY TECH(DONGGUAN)LTD.	E216734	130° C
5	VARNISH	MP-2562F-26 (Y)	HITACHI CHEMICAL CO LTD	E72979	130° C

DASH NO 注册号	PART NO 零件号	REV. 版本	DESCRIPTION 描述	NOTES 备注

WHERE USED 用途: GTM91092-110M

LOCATION 位置: GTS

INIT. BY: 申请人: 日期: 2008.11.10

DRAWN: 制图: 日期: 2008.11.10

APPROVED: 批准: 日期: 2008.11.10

文件内容未经许可不得更改
Contents of this document are subject to change without prior notice

GlobTek(Shanghai), Co., Ltd

Tel: +86-21-6916-8033 Fax: +86-21-6916-9422 Web: www.globtek.cn

DWG Title 图纸标题:
25uH 10A Buck Output Choke for GTM91092-110-M-L106

MODEL NO 型号: GTM91092-110-M
PART NO 零件号: 321-1000100(R)
SCALE 比例: 1:1
SHEET 1 OF 1

<p>REV. 版本</p> <p>A</p> <p>B</p>		<p>REVISION 修订本</p> <p>DESCRIPTION 描述</p> <p>INITIAL RELEASE 初始版本</p> <p>Adjustment of the tolerance of the wire to meet core balanced adjust wire to 1.0mm</p>		<p>DATE 日期</p> <p>2008.11.07</p> <p>2008.11.22</p>		<p>APPROVED 批准</p> <p>RYAN</p> <p>RYAN</p>															
<p>文件控制:</p> <p>本文件所有权属于 GLOBTEK 公司，任何复制或修改均须经 GLOBTEK 公司批准。任何复制或修改 GLOBTEK 公司的文件，均须经 GLOBTEK 公司批准。本文件在 GLOBTEK 公司或其子公司、分公司、办事处、代理商、客户、供应商、合作伙伴或任何其他方使用，均须经 GLOBTEK 公司批准。本文件在 GLOBTEK 公司或其子公司、分公司、办事处、代理商、客户、供应商、合作伙伴或任何其他方使用，均须经 GLOBTEK 公司批准。本文件在 GLOBTEK 公司或其子公司、分公司、办事处、代理商、客户、供应商、合作伙伴或任何其他方使用，均须经 GLOBTEK 公司批准。本文件在 GLOBTEK 公司或其子公司、分公司、办事处、代理商、客户、供应商、合作伙伴或任何其他方使用，均须经 GLOBTEK 公司批准。</p>																					
<p>1. MECHANICAL ASSEMBLY: (UNIT) : mm</p> <p>机构组装图: (单位) : mm</p>		<p>2. SCHEMATIC:</p> <p>线路图</p>																			
<p>NOTE:</p> <p>1. 绕线均匀平整</p> <p>THE WINDING SHOULD BE EVEN</p> <p>2. 成品底部侧脚需点焊固定 (共两点) 如图示</p> <p>EPOXY FIXING ON THE BOTTOM AS THE DRAWING (TWO POINT)</p> <p>3. 成品需涂漆</p> <p>VARNISH REQUIREMENT</p>																					
<p>HI-POT TEST: AC 50Hz/5mA</p> <p>APPLY 500VDC COIL - COIL AND COIL - CORE FOR 60 SEC</p>		<table border="1"> <thead> <tr> <th>NO</th> <th>START</th> <th>FINISH</th> <th>WIRE SIZE</th> <th>COLOR</th> <th>TURNS</th> <th>INDUCTANCE</th> </tr> </thead> <tbody> <tr> <td>NI</td> <td>1</td> <td>2</td> <td>1.0mm</td> <td></td> <td>9T</td> <td>400μH±50%</td> </tr> </tbody> </table>						NO	START	FINISH	WIRE SIZE	COLOR	TURNS	INDUCTANCE	NI	1	2	1.0mm		9T	400μH±50%
NO	START	FINISH	WIRE SIZE	COLOR	TURNS	INDUCTANCE															
NI	1	2	1.0mm		9T	400μH±50%															
<p>APPROVED</p> <p>By Jayson B. at 11:24 am, 11/24/08</p>		<p>WHERE USED 应用:</p> <p>GTMB1092-110M</p>		<p>LOCATION 区域:</p> <p>GTS</p>		<p>WHERE USED 应用:</p> <p>GTMB1092-110M</p>															
<p>NO</p> <p>1</p> <p>2</p> <p>3</p> <p>4</p> <p>5</p>		<p>MATERIAL</p> <p>WIRE: JPEW WIRE</p> <p>CORE: TORONKA</p> <p>UL TUBE: DONGGUAN QUANTAL ELECTRONICS CO., LTD</p> <p>EPOXY: C 85004/B</p> <p>WARNISH: TP-9582F-26 (1)</p>		<p>SUPPLIER</p> <p>PACIFIC TRONTRIC WIRE & CABLE CO., LTD</p> <p>DONGGUAN QUANTAL ELECTRONICS CO., LTD</p> <p>CINAK CHEMISTRY TECH (DONGGUAN) LTD.</p> <p>HITACHI CHEMICAL CO LTD</p>		<p>CLASS</p> <p>UL NO</p> <p>E201757</p> <p>E227136</p> <p>E216738</p> <p>E72979</p>															
<p>GLOBAL</p> <p>本文件在 GLOBTEK 公司或其子公司、分公司、办事处、代理商、客户、供应商、合作伙伴或任何其他方使用，均须经 GLOBTEK 公司批准。</p>		<p>GLOBAL</p> <p>本文件在 GLOBTEK 公司或其子公司、分公司、办事处、代理商、客户、供应商、合作伙伴或任何其他方使用，均须经 GLOBTEK 公司批准。</p>		<p>GLOBAL</p> <p>本文件在 GLOBTEK 公司或其子公司、分公司、办事处、代理商、客户、供应商、合作伙伴或任何其他方使用，均须经 GLOBTEK 公司批准。</p>		<p>GLOBAL</p> <p>本文件在 GLOBTEK 公司或其子公司、分公司、办事处、代理商、客户、供应商、合作伙伴或任何其他方使用，均须经 GLOBTEK 公司批准。</p>															

APPROVED
By Jayson B. at 11:27 am, 11/26/08

所有修改量:
本文件所有修改量于 GLOBTEK 公司, 任何修改量均须由 GLOBTEK 公司核准, 未经授权, 不得擅自修改。
PROPRIETARY INFORMATION:
GLOBTEK COMPANY PROPRIETARY INFORMATION. ANY REPRODUCTION, DISCLOSURE OR USE OF THIS DRAWING IN WHOLE OR IN PART, IS HEREBY PROHIBITED EXCEPT AS SPECIFIED IN WRITING BY GLOBTEK, INC.

REVISION 修订本
DESCRIPTION 描述
DATE 日期
APPROVED 批准
INITIAL RELEASE 初始版本
RYAN
2008.11.07
2008.11.22
RYAN

REV 版本
A
B
Adjust inductance tolerance to +/-30% to match core tolerance

1. MECHANICAL ASSEMBLY: (UNIT) :mm
机构组装图: (单位) :mm

2. SCHEMATIC:
线路图

NOTE:
1. 绕线均匀平整
THE WINDING SHOULD BE EVEN
2. 成品底部两侧需点胶固定 (共两点) 如图示
EPOXY FIXING ON THE BOTTOM AS THE DRAWING (TWO POINT)
3. 成品需含浸
VARNISH REQUIREMENT

NO	START	FINISH	WIRE SIZE	COLOR	TURNS	INDUCTANCE
NI	1	2	0.75mm		8T	280uH±30%

HI-POT TEST AC 50Hz/5mA
APPLY 5000VDC COIL - COIL AND COIL - CORE FOR 60 SEC

NO	NAME	MATERIAL	SUPPLIER	UL NO	CLASS
1	WIRE	TYPE WIRE	PACIFIC TRONIC WIRE & CABLE CO., LTD	E201751	166° C
2	CORE	ACME T100X4 SHUNTA OR 10X4-SH			
3	TUBE	UL TUBE	DONGGUAN QUANTAL ELECTRONICS CO., LTD	E272338	125° C
4	EPOXY	G 8500A/B	CIDAK CHEMISTRY TECH(DONGGUAN)LTD.	E216739	130° C
5	VARNISH	WV-2582-25 (V)	HIITACHI CHEMICAL CO LTD	E72979	130° C

DASH NO 注册号	PART NO 零件号	REV 版本	DESCRIPTION 描述	NOTES 备注

WHERE USED 用處: GTM91092-110M
LOCATION 區域: GTS

TOLERANCES 公差:
DECIMALS 小數: ± .005
ANGULAR 角度: ± .5
MILLIMETERS 毫米: ± .03
JXX ± .03
JXX ± .03

DATE: 2007.11.22
日期: 2007.11.22
DATE: 2007.11.22
日期: 2007.11.22
DATE: 2007.11.22
日期: 2007.11.22

INIT BY: 申請人: G.L
DRAWN: 繪圖: RYAN
APPROVED: 批准: RYAN

SCALE 比例: 1:1

SHEET 1 OF 1

GlobTek(Suzhou), Co., Ltd
Tel: +86-21-6916-2053 Fax: +86-21-6916-0422 Web: www.globtek.cn

DWG Title 图纸标题:
280uH 3A Differential Choke for GTM91092-110-M, L105 and L109

MODEL NO 型号: GTM91092-110-M
PART NO 零件号: 321-10001005R
REV 版本: B

文件内容未经过审核
Contents of this document are subject to change without prior notice

声明:
Globtek 公司不对本产品在制造过程中因使用不当而造成之损坏负责, 且不承担任何因使用不当而造成之损坏。
UL、CSA 认证标准须经认证机构核准。
Lineation of Use:
Globtek products are not authorized for use as mission critical components in life support, hazardous environment, nuclear or aircraft applications without prior approval from the CEO of Globtek Inc.

免責聲明:
Globtek 公司不為本產品在製造過程中因使用不當而造成之損壞負責, 且不承担任何因使用不當而造成之損壞。
UL、CSA 認證標準必須經核准。
Lineation of Use:
Globtek Inc. will not be liable for the safety and performance of these parts if unauthorized access and repair occurs. End user must refer to the applicable UL, CSA or EN standards for product installation instructions.

APPROVED
By Jayson B. at 2:54 pm, 11/7/08

REV	REVISION	DATE	APPROVED
A	RELEASE FOR QUOTATION 报价版本	2008.11.07	RYAN

所有权利属：GLOBTEK 公司，任何复制或再生产的资料都必须禁止和非法的，除非取得 GLOBTEK 公司的书面许可。
 ALL RIGHTS RESERVED BY GLOBTEK INC. ANY REPRODUCTION, DISCLOSURE OR USE OF THIS DRAWING IN WHOLE OR PART, IS HEREBY PROHIBITED EXCEPT AS SPECIFIED IN WRITING BY GLOBTEK INC.

1. MECHANICAL ASSEMBLY: (UNIT) :mm

2. SCHEMATICAL:

3. ELECTRONICS WIRE&TURS: AT 1KHz /0.25V (CHEN HWA CH100)

NO	START	FINISH	WIRE SIZE	COLOR	TURNS	INDUCTANCE
NI	1, 2	3, 4	0.2#X2	RED, GREEN	10T	130 μH

4. HI-POT TEST: AC 50Hz/5mA
APPLY 500V COIL TO COIL AND COIL TO CORE FOR 60 SEC

NO	NAME	MATERIAL	SUPPLIER	UL NO	CLASS
1	WIRE	IPEW WIRE	PACIFIC TRONTRIC WIRE & CABLE CO., LTD	E201757	155° C
2	CORE	A10 TB X4 X4 OR 8X4 X4			
3	TUBE	UL TUBE	DONGGUAN QUANTAI ELECTRONICS CO., LTD	E227336	125° C
4	EPOXY	G 8500A/B	GUDAK CHEMISTRY TECH (DONGGUAN) LTD.	E216733	130° C
5	VARNISH	WP-2952F-2G (Y)	HITACHI CHEMICAL CO LTD	E72979	130° C

SPECIFICATION CONTROL DRAWING

DASH NO	PART NO	REV.	DESCRIPTION	NOTES

NOTE:

1. 绕线均匀平整，铜线不可破皮，打结等
2. 出入线点需做固定共四点如图示

WHERE USED: GTM91092-110-M
LOCATION: GTS
INIT. BY: DATE: 2008.11.07
DRAWN: G.L DATE: 2008.11.07
APPROVED: RYAN DATE: 2008.11.07

TOLEANCES:
 DECIMALS: XX ± .05
 ANGULAR: AL ± 1°
 HLLMETERS: XX ± .03
 SIZE: AL ± .03

GLOBALTEK(Suzhou), Co., Ltd
 Tel: +86-21-6916-0952 Fax: +86-21-6916-0423 Web: www.globtek.cn
DWG Title: 130uH 1A Common Mode Choke for GTM91092-110-M L113 and L114

SCALE: 1:5.1
SHEET: 1 OF 1

Limitation of Use:
 Globtek product are not authorized for use as mission critical components in life support, aerospace and military applications without approval from the CEO of Globtek Inc.

APPROVED By Jayson B. at 3:02 pm, 11/7/08		所有数据: 本文件所有数据于 GLOBTEK 公司, 任何复制或部分复制或全部复制或禁止非授权的, 除非取得 GLOBTEK 公司的书面授权。 PROPERTY OF GLOBTEK, INC. ANY REPRODUCTION, DISCLOSURE OR USE OF THIS DRAWING IN WHOLE OR PART, IS HEREBY PROHIBITED EXCEPT AS SPECIFIED, IN WRITING BY GLOBTEK, INC.		REVISION DESCRIPTION PROTO. RELEASE Change core and update drawing		DATE 2007.4.11 2008.11.02		APPROVED REV. RYAN		
1. MECHANICAL ASSEMBLY: (UNIT) :mm										
Heat Shrink Tubing			EPDXY			7.540.5		7.540.5		
3. ELECTRONICS WIRE&TURNS: AT 1KHz / 0.25V (CHEN HWA CH100)		INDUCTANCE		REMARKS						
NO	START	FINISH	WIRE SIZE	COLOR	TURNS			INDUCTANCE		
N1	1	2	0.85*1	GREEN	7T			80uH Min.	N1 AND N2 BIFILAR WOUND	
N2	3	4	0.85*1	RED	7T	80uH Min.				
4. HI-POT TEST: AC 50Hz/5mA										
APPLY 500V COIL TO COIL AND COIL TO CORE FOR 60 SEC										
NO	NAME	MATERIAL	SUPPLIER		UL NO	CLASS				
1	WIRE	IPEW WIRE	PACIFIC TRONTRIC WIRE & CABLE CO., LTD		E201757	155° C				
2	CORE	FERRITE	CHILLSHIN, PN:HFT10*6*4-C, GREEN							
3	TUBE	UL TUBE	DONGGUAN QUANTAI ELECTRONICS CO., LTD		E227336	125° C				
4	EPOXY	G 8500A/B	GUDAK CHEMISTRY TECH (DONGGUAN) LTD.		E216733	130° C				
5	VARNISH	WP-2952F-26 (Y)	HITACHI CHEMICAL CO LTD		E72979	130° C				
6	TUBING	HEAT SHRINK TUBING								
备注: Globtek 公司对其标准而应用此零件而影响的完全性能负责, 最终用户必须遵守 UL, CSA 等国际标准进行零件安装。 Note: Globtek Inc. will not be liable for the safety and performance of these parts if unauthorized access and repair occurs. End users are responsible for following all applicable standards for proper installation. Instructions.			限制: Globtek 公司对其标准而应用此零件而影响的完全性能负责, 最终用户必须遵守 UL, CSA 等国际标准进行零件安装。 Limitation of Use: Globtek product are not authorized for use as mission critical components in life support, aerospace, nuclear, nuclear or aircraft applications without written approval from the CEO of Globtek Inc.			文件内容本零件大小得更改 Contents of this document are subject to change without prior notice				
SPECIFICATION CONTROL DRAWING				WHERE USED: GT1871082-110-M		TOLERANCES:		GLOBAL GLOBTEK(Suzhou), Co.,Ltd		
DASH NO	PART NO	REV.	DESCRIPTION	NOTES	DECIMALS ANGULAR XXX ± .015 ± .1 HLLIMITES ANGULAR JXX ± .013 ± .1		TEL: +86-21-6916-9053 Fax: +86-21-6916-9422 Web: www.globtek.cn DWG Title: 80uH,1A Common Mode Choke for LHF2 模块 L116			
DATE: 2008.11.02		DATE: 2008.11.02		DATE: 2008.11.02		SCALE: 1:1		SHEET 1 OF 1		
GTS		GIL		RYAN		GTMP1092-110-M		PART NO: 321-002-8001(R)		
DRAWN: GIL		APPROVED: RYAN		DATE: 2008.11.02		MODEL NO: GTMP1092-110-M		REV. B		

所有複製品均應註明: GLOBTEK 公司, 在複製品標明部分或全部禁止再製的, 除專製得 GLOBTEK 公司所發給之許可外, 不得再製。 ALL REPRODUCTIONS OF THIS DRAWING SHALL BE THE PROPERTY OF GLOBTEK, INC. ANY REPRODUCTION, DISCLOSURE OR USE OF THIS DRAWING WITHOUT THE WRITTEN PERMISSION OF GLOBTEK, INC. IS PROHIBITED.		REVISION DESCRIPTION DATE APPROVED INITIAL RELEASE 初版核准 2008.11.07 RYAN
1. MECHANICAL ASSEMBLY: (UNIT) :mm 1. 機械組裝: 	2. SCHEMATIC: 	
3. ELECTRONICS WIRE&TURNS: AT 1KHz / 0.25V (CHEN HWA CH100) 3. 電子線材與圈數: 在 1KHz / 0.25V (陳華 100)		
4. HI-POT TEST: AC 50Hz/5mA APPLY 500V COIL TO CORE FOR 60 SEC 4. 高壓測試: AC 50Hz/5mA 將 500V 加在磁心線圈上 60 秒	NOTE: 1. 繞線均勻平整 THE WINDING SHOULD BE EVEN 2. 成品底部兩側需點焊固定 (共兩點) 如圖示 EPOXY FIXING ON THE BOTTOM AS THE DRAWING (TWO POINT) 3. 成品需含漆 VARNISH REQUIREMENT	
SPECIFICATION CONTROL DRAWING		
DASH NO PART NO REV. DESCRIPTION NOTES		
WHERE USED: GTM91092-110-M		
LOCATION: GTS		
INT. BY: DATE: 2008.11.07		
DRAWN: G/L DATE: 2008.11.07		
APPROVED: RYAN DATE: 2008.11.07		
TOLERANCES: DECIMALS ± .015 ANGULAR ± 1° HOLE ± .005 MILLIMETERS ± .13 ANGULAR ± 1°		
SIZE: A MODEL NO: GTM1092-110-M PART NO: 331-0201402(R) REV. A		
SCALE: 1:1 SHEET 1 OF 1		
GlobTek(Suzhou), Co., Ltd Tel: +86-21-6915-0055 Fax: +86-21-6915-0422 Web: www.globtek.cn		
DWG Title: 400uH 4A Diff Choke for GTM91092-110-M L302		

NO	START	FINISH	WIRE SIZE	COLOR	TURNS	INDUCTANCE	UL NO	CLASS
N1	S	F	2U2W+NY 0.6*1		82.6T's (RBF)	400uH ± 20%	E201757	155 ° C
4. HI-POT TEST: AC 50Hz/5mA APPLY 500V COIL TO CORE FOR 60 SEC								
NO	NAME	MATERIAL	SUPPLIER	UL NO	CLASS			
1	WIRE	2U2W+NY WIRE	PACIFIC TRONTRIC WIRE & CABLE CO., LTD	E201757	155 ° C			
2	CORE	160-26	CORE TECHNOLOGY, LTD OR EQU					
3	EPOXY	Black gum	GUDAK CHEMISTRY TECH (DONGGUAN) LTD.	E216733	130 ° C			
4	VARNISH	8562/C	HANG CHEUNG PETROCHEMICAL, LTD.	E200154	155 ° C			
5	HEAT SHRINK TUBING							

注意: GlobTek 公司之所有產品均應遵照其產品說明書之安全與使用說明書。 GlobTek 公司之產品均應遵照其產品說明書之安全與使用說明書。 GlobTek 公司之產品均應遵照其產品說明書之安全與使用說明書。	聲明: GlobTek 產品未經核准不得用於任何醫療設備中, 以及醫療設備或醫療器械之配件。 GlobTek 公司之產品均應遵照其產品說明書之安全與使用說明書。
限制: GlobTek 公司之產品均應遵照其產品說明書之安全與使用說明書。 GlobTek 公司之產品均應遵照其產品說明書之安全與使用說明書。 GlobTek 公司之產品均應遵照其產品說明書之安全與使用說明書。	限制: GlobTek 公司之產品均應遵照其產品說明書之安全與使用說明書。 GlobTek 公司之產品均應遵照其產品說明書之安全與使用說明書。 GlobTek 公司之產品均應遵照其產品說明書之安全與使用說明書。

所有权利保留 本文件所有权利属于 _globtek 公司，任何载体前部分或全部复制或再 止 均被禁止。 除非取得 _globtek 公司书面许可。 ALL RIGHTS RESERVED PROPRIETARY OF GLOBTEK, INC. ANY REPRODUCTION, DISCLOSURE OR USE OF THIS DRAWING IN WHOLE OR PART, IS HEREBY PROHIBITED EXCEPT AS SPECIFIED IN WRITING BY GLOBTEK, INC.		REVISION DESCRIPTION DATE APPROVED RYAN RYAN					
REV A B	PROTO RELEASE Update drawing and release for pilot production	DATE 2008.11.10 2008.11.11					
1. MECHANICAL ASSEMBLY: (UNIT) :mm 2. SCHEMATIC:							
3. ELECTRONICS WIRE&TURNS: AT 1kHz /0.25V (CHEN HWA CH100)							
NO	START	FINISH	WIRE SIZE	COLOR	TURNS	INDUCTANCE	REMARKS
N1	1	2	1.0*1	GREEN	6T	20uH Min.	N1 AND N2 BIPOLAR WOUND
N2	3	4	1.0*1	RED	6T	20uH Min.	
NO	NAME	MATERIAL	SUPPLIER	UL NO	CLASS		
1	WIRE	IPFW WIRE	PACIFIC TRONTRIC WIRE & CABLE CO., LTD	E201757	155° C		
2	CORE	FERRITE	T12. 5*6. 5*4. 2, GREEN				
3	TUBE	UL TUBE	DONGGUAN QUANTAI ELECTRONICS CO., LTD	E227336	125° C		
4	EPOXY	G 8500A/B	GUDAK CHEMISTRY TECH(DONGGUAN) LTD.	E216733	130° C		
5	VARNISH	WP-2952F-2G (Y)	HITACHI CHEMICAL CO LTD	E72979	130° C		
WHERE USED: GTM81092-110-M		TOLERANCES: DECIMALS XX ± 0.1 ± f XXX ± 0.05 ± f ALL DIMENSIONS ANGULAR XXX ± 0.15 ± f		GlobTek(Suzhou), Co.,Ltd Tel: +86-21-6916-0055 Fax: +86-21-6916-0022 Web: www.globtek.cn			
LOCATION: GTS	DATE: 2008.11.10 INIT. BY:	DATE: 2008.11.10 DRAWN: GUL	DWG Title: 20uH 10A Common Mode Choke for GTM81092-110-M L115, L117	MODEL NO: GTM81092-110-M	PART NO: 321-02012001(R)		
APPROVED: RYAN	SCALE: 1:1	REV.	SHEET 1 OF 1				

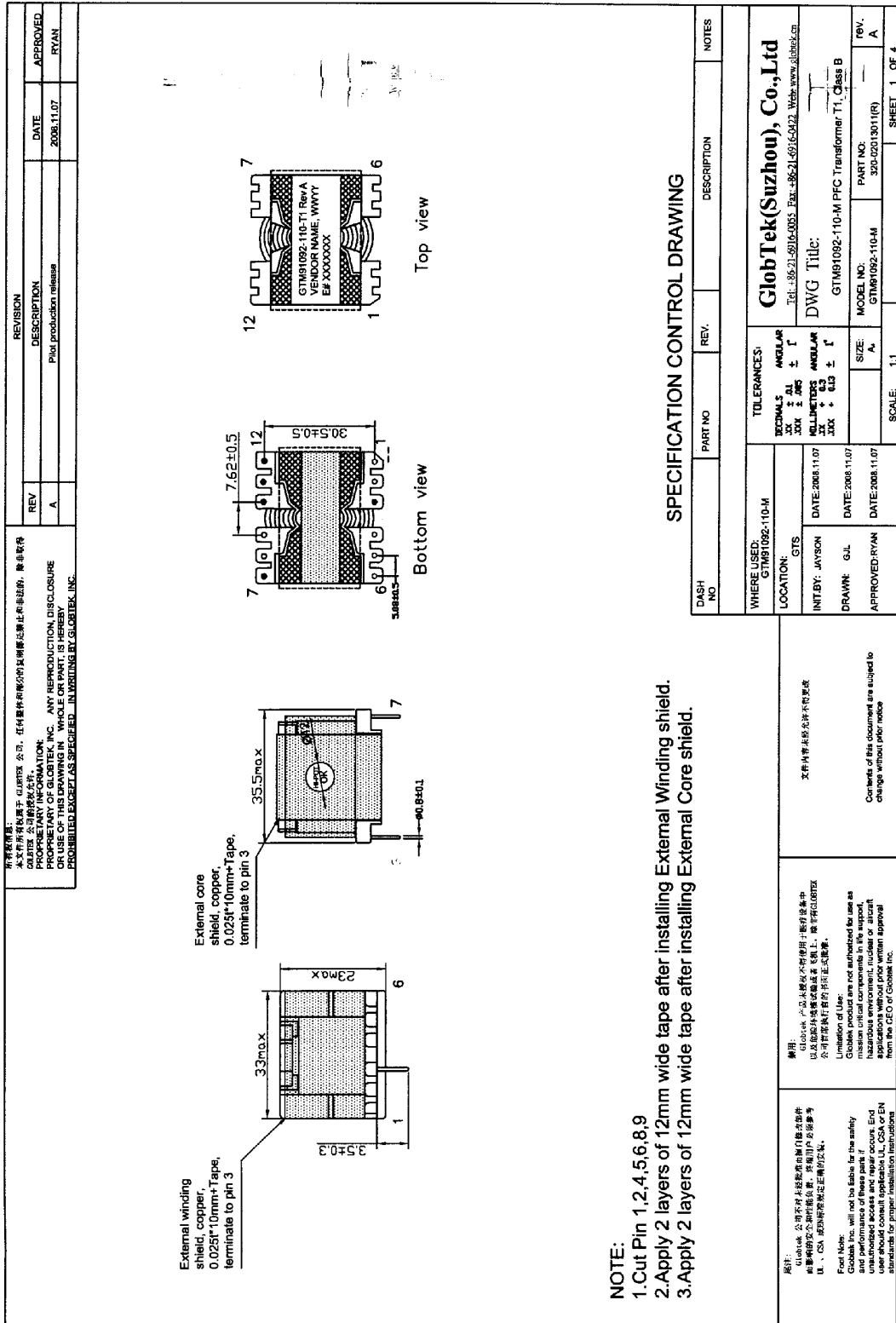

<p>所有資料 本文件所載係屬 Globtek 公司，任何圖樣和零件之名稱及圖樣均受專利保護，嚴禁複製。 Globtek 公司保留所有權利。 PROPRIETARY INFORMATION GLOBTEK INC. ANY REPRODUCTION, DISCLOSURE OR USE OF THIS DRAWING IN WHOLE OR PART IS HEREBY PROHIBITED EXCEPT AS SPECIFIED IN WRITING BY GLOBTEK INC.</p>	<table border="1" style="width: 100%; border-collapse: collapse;"> <tr> <th>REV</th> <th>DESCRIPTION</th> <th>DATE</th> <th>APPROVED</th> </tr> <tr> <td>A</td> <td>File production drawing</td> <td>2008.11.07</td> <td>RYAN</td> </tr> </table>	REV	DESCRIPTION	DATE	APPROVED	A	File production drawing	2008.11.07	RYAN	<h3>SCHEMATIC DIAGRAM</h3>	
REV	DESCRIPTION	DATE	APPROVED								
A	File production drawing	2008.11.07	RYAN								
<p>PRI</p>	<p>SEC</p>	<h3>WINDING SEQUENCE</h3>									
<p>● MEANS START</p> <p>— PVC TUBE</p>		<h3>BOBBIN</h3>									
<p>N1 = 49Ts*0.2*8 Litz, UEW N2 = 5.5Ts*0.22*2, UEW</p>											
<h3>SPECIFICATION CONTROL DRAWING</h3>											
DASH NO	PART NO	REV.	DESCRIPTION								
			<p>GlobTek(Suzhou), Co.,Ltd Tel: +86-21-6916-0095 Fax: +86-21-6916-0023 Web: www.globtek.cn</p> <p>GTMS1092-110-M</p> <p>WHERE USED: GTMS1092-110-M</p> <p>LOCATION: GTS</p> <p>INIT BY: JAYSON</p> <p>DATE: 2008.11.07</p> <p>DRAWN: GL</p> <p>DATE: 2008.11.07</p> <p>APPROVED: RYAN</p> <p>DATE: 2008.11.07</p>								
<p>MECHANICAL XX ± 0.1 XXX ± 0.05</p> <p>ANGULAR ± 1'</p>		<p>GTMS1092-110-M Class B</p> <p>GTMS1092-110-M</p>									
<p>NET WEIGHT XX ± 0.05 XXX ± 0.05</p> <p>ANGULAR ± 1'</p>		<p>GTMS1092-110-M Class B</p> <p>GTMS1092-110-M</p>									
<p>SCALE: 1:1</p>		<p>MODEL NO. GTMS1092-110-M</p> <p>PART NO. 320-02013011(R)</p>									
<p>APPROVAL FLOW: 1. CUSTOMER (INHOUSE/OUTSIDE)</p>		<p>APPROVAL FLOW: 2. ENG. Q. MANAGER (CHECK/REVIEW)</p> <p>3. MECH. ENGR (DRAW/CHECK)</p> <p>4. ENG. MANAGER (REVIEW/APPROVE/FILE KEEPING/ENG and QA ASSISTANT)</p> <p>5. OPRN. MANAGER (RELEASE TO MECH. ENGR)</p> <p>6. RELEASE TO MECH. ENGR</p> <p>7. END CUSTOMER (INHOUSE/OUTSIDE)</p>									
<p>備註: Globtek 公司未經核准不得將此圖樣或零件用於任何產品，嚴禁複製。 Globtek 公司保留所有權利。 Limitation of User: Globtek product are not authorized for use as replacement parts in aircraft, nuclear or aircraft applications without prior written approval from the CEO of Globtek Inc.</p> <p>Foot Note: Globtek, Inc. will not be liable for the safety of the product if the user does not follow the instructions and standards for proper installation instructions.</p>											

所有数据属 Globtek 公司，任何具体数据均受专利保护，除非取得 文件所有者的书面许可，不得复制或传播。 ALL INFORMATION CONTAINED HEREIN IS PROPRIETARY AND UNCLASSIFIED PROPRIETARY INFORMATION. ANY REPRODUCTION, DISCLOSURE OR USE OF THIS DRAWING IN WHOLE OR PART, IS HEREBY PROHIBITED EXCEPT AS SPECIFIED IN WRITING BY GLOBTEK, INC.		REVISION DESCRIPTION DATE APPROVED RYAN		
REV	A	Pilot production release	2008.11.07	RYAN

所有数据属 Globtek 公司，任何具体数据均受专利保护，除非取得 文件所有者的书面许可，不得复制或传播。 ALL INFORMATION CONTAINED HEREIN IS PROPRIETARY AND UNCLASSIFIED PROPRIETARY INFORMATION. ANY REPRODUCTION, DISCLOSURE OR USE OF THIS DRAWING IN WHOLE OR PART, IS HEREBY PROHIBITED EXCEPT AS SPECIFIED IN WRITING BY GLOBTEK, INC.		REVISION DESCRIPTION DATE APPROVED RYAN		
REV	A	Pilot production release	2008.11.07	RYAN

Electrical Specifications

INDUCTANCE TEST	1kHz, 0.25V L(7-10,11): 300uH ±5%
DCR TEST	25°C R(7-10,11): 220mOhm Max. R(3-12): 125 mOhm Max.
	AC 500V/60Hz/5mA hi-pot for one second between pri to sec.
	AC 1.5KV/60Hz/5mA hi-pot for one second between pri to core. AC 1.5KV/60Hz/5mA hi-pot for one second between pri to core.
TERMINAL STRENGTH	1.0 Kg on terminals for 30 seconds, test the breakdown

SPECIFICATION CONTROL DRAWING

DASH NO.	PART NO.	REV.	DESCRIPTION	NOTES
WHERE USED: GTM91092-110-M		TOLERANCES: DECIMALS ANGULAR .XX ± .005 ± .1 .XX ± .005 ± .1 MILLIMETERS ANGULAR .XX ± .03 ± .1 .XX ± .03 ± .1		
LOCATION: GTS		GlobTek (Suzhou), Co., Ltd Tel: 86-21-60165055 Fax: 86-21-60165022 Web: www.globtek.cn DWG Title: GTM91092-110-M PFC Transformer Class B		
INIT. BY: JAYSON	DATE: 2008.11.07	SCALE: 1:1	MODEL NO: GTM91092-110-M	PART NO: 320-0201-9011(R)
DRAWN: GJL	DATE: 2008.11.07		APPROVED: RYAN	DATE: 2008.11.07
APPROVAL FLOW: 1. CUSTOMER (IN/HOUSE/OUTSIDE) → 2. ENG'G MANAGER (CHECK/REV/EN) → 3. MECH. ENGR (DRAW/CHECK) → 4. ENG'G MANAGER (REVIEW/APPROVE/FILE KEEPING/ENGR AND QAE ASSISTANT) → 5. SUPRN MANAGER → 6. RELEASE TO MECH. ENGR → 7. END CUSTOMER (IN/HOUSE/OUTSIDE)		SHEET 3 OF 4		

备注:
 Globtek 产品未经书面授权不得用于除行设备中
 以及民用航空器以外的其他用途，除非有 Globtek
 公司书面授权书的支持。
 Limitation of Use:
 Globtek product are not authorized for use as
 mission critical components in the support
 applications without prior written approval
 from the CEO of Globtek, Inc.

说明:
 Globtek 公司不对未经授权擅自修改零件
 而影响的性能和寿命负责，终端用户必须参考
 Globtek Inc. will not be liable for the safety
 and performance of these parts if
 unauthorized modifications are made. End
 user should consult applicable UL, CSA or EN
 standards for proper installation instructions

文件内容未经允许不得更改
 Contents of this document are subject to
 change without prior notice

REVISION		DATE	APPROVED
REV	DESCRIPTION		
A	Prod production release	2008.11.07	RYAN

本文件所有权属于 GLOBTEK 公司。任何复制或修改本文件的行为均须事先获得 GLOBTEK 公司的书面许可。 PROPRIETARY INFORMATION: GLOBTEK, INC. ANY REPRODUCTION, DISCLOSURE OR USE OF THIS DRAWING IN WHOLE OR PART IS HEREBY PROHIBITED EXCEPT AS SPECIFIED IN WRITING BY GLOBTEK, INC.	
--	--

COMPONENT PART.	MATL	MANUFACTURE	FILE NO.
1. Bobbin	Phenolic 94V-0 T375J,T373J 150°C	Chang Chun plastics co.,ltd.,	E59481(S)
2. Core	3C90,3C96,TP4A,PC44	Ferrite core:PQ3220 FERROXCUBE,TDG,TDK,PHILIPS.	
3. Wire	UEW UEW-4	Pacific electric wire & cable co.,ltd Jung Shing wire co.,ltd.	E197768 E201757 E174837
4. Mylar tape	3M 1350F-1	3M Company	E173985
5. Terminals	Tin coated-copper wire	Well Fore Special wire corp.	
6. Varnish	468-2FC+ BC-359 BC-346A	PD George co./ripley resin. John C Dolph co.,ltd	E81777(N) E51047(M)
7. Tube	TFL Tube 200°C 150V	Great holding industrial co.,ltd.	E156256(S)
8. Solder	96.5%Sn, 3%Au, 0.5%Cu	Xin Yuan co.,ltd.	
9. Shield	copper foil	shanghai taifu copper production co.,ltd. copper : foil, 0.025*10mm+Tape	

说明: Globtek 公司对本规格书所规定的材料规格及性能要求, 应遵照/必须参考 UL, CSA 或同等规格规定的标准。 Note: Globtek, Inc. will not be liable for the safety and performance of these parts if used in applications other than those specified. End user should consult applicable UL, CSA or EN standards for proper trade information.	限制: Globtek 产品未经授权不得用于任何医疗设备以及医疗设备制造商的医疗设备上。除非经 GLOBTEK 公司许可, 否则不得用于医疗设备。 Limitation of Use: Globtek product are not authorized for use as mission critical components in life support applications without prior written approval from the CEO of Globtek Inc.	文件内容未经批准不得更改 Contents of this document are subject to change without prior notice
---	--	--

2. ENG. C. MANAGER (ORIG./REV./RW) 3. MECH. ENGR (DRAW/RECK)	4. ENGS. MANAGER (REVIEW/APP/PRO/VEP/PE/KEEPING/ENG and O/E ASSISTANT) 5. OP/PRN. MANAGER 6. RELEASE TO MECH. ENGR 7. END CUSTOMER (IN HOUSE/OUTSIDE)
---	--

DASH NO.	PART NO.	REV.	DESCRIPTION	NOTES
			WHERE USED: GTM91092-110-M LOCATION: GTS INIT. BY: JANSON DATE: 2008.11.07 DRAWN: G.L DATE: 2008.11.07 APPROVED: RYAN DATE: 2008.11.07	
TOLERANCES: DECIMALS: ANGULAR .XXX ± .005 .XX ± .03 .XX ± .03		GlobTek(Suzhou), Co.,Ltd Tel: +8621-69165005 Fax: +8621-69165022 Web: www.globtek.cn DWG Title: GTM91092-110-M PFC Transformer T1, Class B MODEL NO: GTM91092-110-M PART NO: 320-0201001(R) REV. A SCALE: 1:1 SHEET 4 OF 4		

SPECIFICATION CONTROL DRAWING

<p style="font-size: small;">所有数据 本公司所有数据属于 山姆迪 公司，任何复制和再分发的行为都是违法的，除非取得 GLOBTEK 公司的授权许可。 PROPRIETARY INFORMATION ANY REPRODUCTION, DISCLOSURE OR USE OF THIS DRAWING IN WHOLE OR IN PART IS HEREBY PROHIBITED EXCEPT AS SPECIFIED IN WRITING BY GLOBTEK INC.</p>	<p style="text-align: center;">REVISION</p> <table border="1" style="width: 100%; border-collapse: collapse;"> <tr> <th>REV</th> <th>DESCRIPTION</th> <th>DATE</th> <th>APPROVED</th> </tr> <tr> <td>A</td> <td>PROTO RELEASE</td> <td>2008.11.13</td> <td>RYAN</td> </tr> <tr> <td>B</td> <td>ADD BASE AND RELAX TOLERANCE OF INDUCTANCE</td> <td>2008.01.04</td> <td>RYAN</td> </tr> </table>	REV	DESCRIPTION	DATE	APPROVED	A	PROTO RELEASE	2008.11.13	RYAN	B	ADD BASE AND RELAX TOLERANCE OF INDUCTANCE	2008.01.04	RYAN	<p style="text-align: center;">2. SCHEMATIC:</p> <p style="text-align: center;">• START N1, N2</p>																																																													
REV	DESCRIPTION	DATE	APPROVED																																																																								
A	PROTO RELEASE	2008.11.13	RYAN																																																																								
B	ADD BASE AND RELAX TOLERANCE OF INDUCTANCE	2008.01.04	RYAN																																																																								
<p style="text-align: center;">1. MECHANICAL ASSEMBLY: (UNIT) : mm</p> <p style="text-align: center;">NOTE: 1) Varnish required</p>	<p style="text-align: center;">3. ELECTRONICS WIRE&TURNS: AT 1KHz /0.25V (CHEN HWA CH100)</p> <table border="1" style="width: 100%; border-collapse: collapse;"> <thead> <tr> <th>NO</th> <th>START</th> <th>FINISH</th> <th>WIRE SIZE</th> <th>COLOR</th> <th>TURNS</th> <th>INDUCTANCE</th> <th>REMARKS</th> </tr> </thead> <tbody> <tr> <td>N1</td> <td>4</td> <td>5</td> <td>0.4 COPPER DIA, TEX #*1</td> <td>YELLOW</td> <td>55T's</td> <td>150uH ± 10%</td> <td></td> </tr> <tr> <td>N2</td> <td>1</td> <td>8</td> <td>0.22#1</td> <td>GOLD</td> <td>165T's</td> <td>1.35mH ± 10%</td> <td></td> </tr> </tbody> </table> <p style="text-align: center;">4. HI-POT TEST: AC 50Hz/5mA APPLY 500V N1 TO N2 FOR 60 SECONDS</p> <table border="1" style="width: 100%; border-collapse: collapse;"> <thead> <tr> <th>NO</th> <th>NAME</th> <th>MATERIAL</th> <th>SUPPLIER</th> <th>UL NO</th> <th>CLASS</th> </tr> </thead> <tbody> <tr> <td>1</td> <td>WIRE</td> <td>UEW WIRE</td> <td>PACIFIC TRONTRIC WIRE & CABLE CO., LTD</td> <td></td> <td>130° C</td> </tr> <tr> <td>2</td> <td>CORE</td> <td>SENDUST</td> <td>CHANG SUNG CORP, P/N: CS203090, BLACK</td> <td></td> <td></td> </tr> <tr> <td>3</td> <td>TUBE</td> <td>UL TUBE</td> <td>DONGGUAN QUANTAI ELECTRONICS CO., LTD</td> <td>E227336</td> <td>125° C</td> </tr> <tr> <td>4</td> <td>EPOXY</td> <td>G 8500A/B</td> <td>GUDAK CHEMISTRY TECH (DONGGUAN) LTD.</td> <td>E216733</td> <td>130° C</td> </tr> <tr> <td>5</td> <td>VARNISH</td> <td>WP-2952P-2G (Y)</td> <td>HITACHI CHEMICAL CO LTD</td> <td>E72979</td> <td>130° C</td> </tr> <tr> <td>6</td> <td>WIRE</td> <td>TEX-E OR TRW-B</td> <td>FURUKAWA CO. OR GREAT LEUFON INDUSTRIAL</td> <td></td> <td>130° C</td> </tr> <tr> <td>7</td> <td>BASE</td> <td>PHENOLIC T375J</td> <td>PIN SHINE INDUSTRIAL CO</td> <td></td> <td>PB-029</td> </tr> </tbody> </table>			NO	START	FINISH	WIRE SIZE	COLOR	TURNS	INDUCTANCE	REMARKS	N1	4	5	0.4 COPPER DIA, TEX #*1	YELLOW	55T's	150uH ± 10%		N2	1	8	0.22#1	GOLD	165T's	1.35mH ± 10%		NO	NAME	MATERIAL	SUPPLIER	UL NO	CLASS	1	WIRE	UEW WIRE	PACIFIC TRONTRIC WIRE & CABLE CO., LTD		130° C	2	CORE	SENDUST	CHANG SUNG CORP, P/N: CS203090, BLACK			3	TUBE	UL TUBE	DONGGUAN QUANTAI ELECTRONICS CO., LTD	E227336	125° C	4	EPOXY	G 8500A/B	GUDAK CHEMISTRY TECH (DONGGUAN) LTD.	E216733	130° C	5	VARNISH	WP-2952P-2G (Y)	HITACHI CHEMICAL CO LTD	E72979	130° C	6	WIRE	TEX-E OR TRW-B	FURUKAWA CO. OR GREAT LEUFON INDUSTRIAL		130° C	7	BASE	PHENOLIC T375J	PIN SHINE INDUSTRIAL CO		PB-029
NO	START	FINISH	WIRE SIZE	COLOR	TURNS	INDUCTANCE	REMARKS																																																																				
N1	4	5	0.4 COPPER DIA, TEX #*1	YELLOW	55T's	150uH ± 10%																																																																					
N2	1	8	0.22#1	GOLD	165T's	1.35mH ± 10%																																																																					
NO	NAME	MATERIAL	SUPPLIER	UL NO	CLASS																																																																						
1	WIRE	UEW WIRE	PACIFIC TRONTRIC WIRE & CABLE CO., LTD		130° C																																																																						
2	CORE	SENDUST	CHANG SUNG CORP, P/N: CS203090, BLACK																																																																								
3	TUBE	UL TUBE	DONGGUAN QUANTAI ELECTRONICS CO., LTD	E227336	125° C																																																																						
4	EPOXY	G 8500A/B	GUDAK CHEMISTRY TECH (DONGGUAN) LTD.	E216733	130° C																																																																						
5	VARNISH	WP-2952P-2G (Y)	HITACHI CHEMICAL CO LTD	E72979	130° C																																																																						
6	WIRE	TEX-E OR TRW-B	FURUKAWA CO. OR GREAT LEUFON INDUSTRIAL		130° C																																																																						
7	BASE	PHENOLIC T375J	PIN SHINE INDUSTRIAL CO		PB-029																																																																						
<p style="font-weight: bold;">SPECIFICATION CONTROL DRAWING</p> <table border="1" style="width: 100%; border-collapse: collapse;"> <tr> <th>DASH NO</th> <th>PART NO</th> <th>REV.</th> <th>DESCRIPTION</th> <th>NOTES</th> </tr> <tr> <td></td> <td></td> <td></td> <td></td> <td></td> </tr> </table>				DASH NO	PART NO	REV.	DESCRIPTION	NOTES																																																																			
DASH NO	PART NO	REV.	DESCRIPTION	NOTES																																																																							
<p>WHERE USED: GTM91092-110-M LOCATION: GTS</p>		<p style="font-weight: bold;">GlobeTek (Suzhou), Co., Ltd</p> <p style="font-size: x-small;">Tel: +86-21-6916-0055 Fax: +86-21-6916-0422 Web: www.globtek.cn</p> <p style="font-weight: bold;">DWG Title: High voltage Flyback Transformer for GTM91092-110-M, L101</p>																																																																									
<p>INIT BY: DATE 2008.01.04 DRAWN: GAL DATE 2008.01.04 APPROVED: RYAN DATE 2008.01.04</p>		<p>MODEL NO: GTM91092-110-M PART NO: 320-02011502(R) SIZE: A₄ SCALE: 1:1</p>																																																																									
<p>REMARKS: 零件规格 GLOBTEK 产品规格书不作为使用于医疗器材中 以及飞机环境测试设备或飞行器上，除非有GLOBTEK 公司书面授权许可的书面正式授权。 Limitation of User: GlobeTek product are not authorized for use as mission critical components in life support equipment, aircraft, or other critical applications without prior written approval from the CEO of GlobeTek Inc.</p>		<p>文内内容仅供参考不作为依据 Contents of this document are subject to change without prior notice.</p>																																																																									

<p>任何複製、修改、再製或轉讓本圖紙，均屬非法。 嚴禁私售。 本圖紙係由 Suzhou Globtek Co., Ltd. 所製，其內容及圖紙均屬 Globtek 公司之財產。 PROPRIETARY INFORMATION. ANY REPRODUCTION, DISCLOSURE, MODIFICATION, REUSE OR DISTRIBUTION OF THIS DRAWING WITHOUT WRITTEN PERMISSION IS PROHIBITED EXCEPT AS SPECIFIED. INVENTED BY GLOBTEK INC.</p>		<p>REVISION</p> <table border="1" style="width: 100%; border-collapse: collapse;"> <tr> <th>REV.</th> <th>DESCRIPTION</th> <th>DATE</th> <th>APPROVED</th> </tr> <tr> <td>A</td> <td>PROTO RELEASE</td> <td>2008.11.13</td> <td>RYAN</td> </tr> <tr> <td>B</td> <td>ADD BASE AND RELAX TOLERANCE OF INDUCTANCE</td> <td>2009.01.04</td> <td>RYAN</td> </tr> </table>		REV.	DESCRIPTION	DATE	APPROVED	A	PROTO RELEASE	2008.11.13	RYAN	B	ADD BASE AND RELAX TOLERANCE OF INDUCTANCE	2009.01.04	RYAN
REV.	DESCRIPTION	DATE	APPROVED												
A	PROTO RELEASE	2008.11.13	RYAN												
B	ADD BASE AND RELAX TOLERANCE OF INDUCTANCE	2009.01.04	RYAN												
			<p style="text-align: center;">SPECIFICATION CONTROL DRAWING</p> <table border="1" style="width: 100%; border-collapse: collapse;"> <tr> <th>DASH NO.</th> <th>PART NO.</th> <th>REV.</th> <th>DESCRIPTION</th> <th>NOTES</th> </tr> <tr> <td></td> <td></td> <td></td> <td></td> <td></td> </tr> </table>	DASH NO.	PART NO.	REV.	DESCRIPTION	NOTES							
DASH NO.	PART NO.	REV.	DESCRIPTION	NOTES											
<p>WHERE USED: GTM91092-110-M</p> <p>LOCATION: GTS</p> <p>INIT BY: DATE: 2008.01.04</p> <p>DRAWN: GJL DATE: 2008.01.04</p> <p>APPROVED: RYAN DATE: 2008.01.04</p>		<p>TOLERANCES:</p> <table border="1" style="width: 100%; border-collapse: collapse;"> <tr> <th>DECIMALS</th> <th>ANGULAR</th> </tr> <tr> <td>.XXX ± .005 ± I</td> <td>± I</td> </tr> <tr> <th>MILLIMETERS</th> <th>ANGULAR</th> </tr> <tr> <td>.XXX ± .03 ± I</td> <td>± I</td> </tr> </table> <p>SIZE: A₁</p> <p>MODEL NO.: GTM91092-110-M</p> <p>PART NO.: GTM91092-110-M</p> <p>SCALE: 1:1</p> <p>SHEET 1 OF 1</p>		DECIMALS	ANGULAR	.XXX ± .005 ± I	± I	MILLIMETERS	ANGULAR	.XXX ± .03 ± I	± I	<p style="text-align: center;">Glob Tek(Suzhou), Co., Ltd</p> <p style="text-align: center;">TEL: +86-21-6916-0055 Fax: +86-21-6916-0422 Web: www.globtek.cn</p> <p style="text-align: center;">DWG Title: High voltage Flyback Transformer for</p>			
DECIMALS	ANGULAR														
.XXX ± .005 ± I	± I														
MILLIMETERS	ANGULAR														
.XXX ± .03 ± I	± I														
<p>用途: 本公司之產品係供作工業用途，其用途及性能之限制，本公司將另行提供詳細之說明書。</p> <p>Limitation of Use: Globtek's product are not authorized for use as military critical components in life support, hazardous environment, nuclear or aircraft applications without written approval from the CEO of Globtek Inc.</p>		<p>說明: 本公司之產品係供作工業用途，其用途及性能之限制，本公司將另行提供詳細之說明書。</p> <p>Limitation of Use: Globtek's product are not authorized for use as military critical components in life support, hazardous environment, nuclear or aircraft applications without written approval from the CEO of Globtek Inc.</p>		<p>又有內容者於光學中將被更改</p> <p>Contents of this document are subject to change without prior notice.</p>											



零件承认书

Material Approval

制造商: Manufacturer	山东宝岩电气有限公司
供应商: Supplier	山东宝岩电气有限公司
供应商料号: Supplier P/N	320-02013010
名称: Part Name	变压器
品名/规格: SPEC	变压器GTM91092-110-M DC/DC Transformer T2 PQ3220 300uH±5% FOR FUJUDA
GlobTek 料号: GlobTek P/N	320-02013010
版本: Edition No	A.0

PS承认章: Approval Stamp	RD承认章: Approval Stamp	QC承认章: Approval Stamp



SPECIFICATION

CUSTOMER	2011.5.26 GLOBTEK (SUZHOU)	PART NAME	TRANSFORMER
MODEL NO.	受控文件 PO3220 发行章	PART NO.	320-02013010

1 DIMENSION(mm)

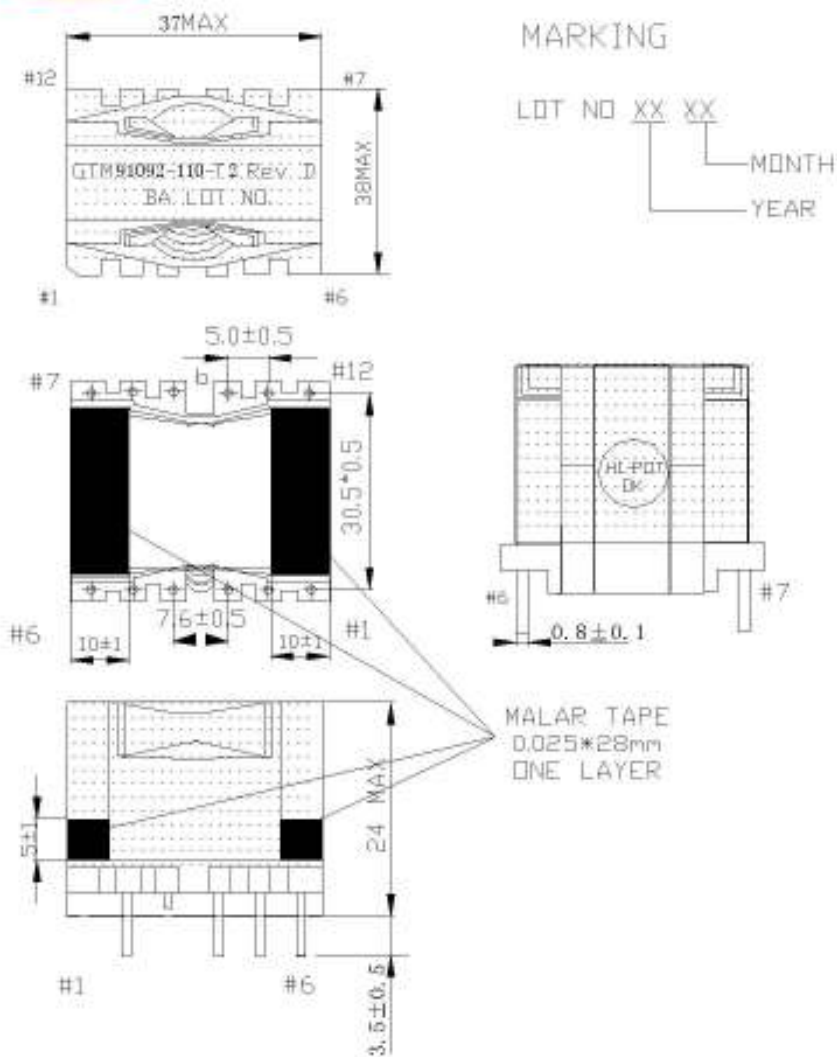

SPEC NO.	KF-10121301-A	DATE	2010.12.13	SHEET NO.	1	
NO.	DATE	REVISION	CHECKED	DESIGN	CHECK	APPROVAL
				黄丽红	潘秀丽	孙恩国

SHANDONG BOAM ELECTRIC CO.,LTD



SPECIFICATION

CUSTOMER	GLOBTEK (SUZHOU)	PART NAME	TRANSFORMER
MODEL NO.	PQ220	PART NO.	320-02013010

2 EQUIVALENT CIRCUIT (BOTTOM VIEW)

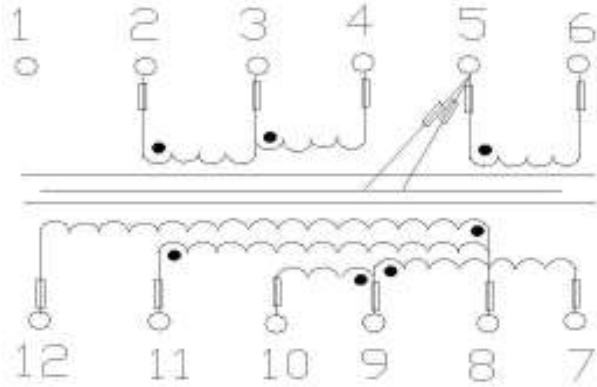

- * THE "⊙" MARKS ARE START POINT
- * CUTTING PIN 3#.
- * ALL TEFLON TUBE

SPEC NO.	KF-10121301-A	DATE	2010.12.13	SHEET NO.	2	
NO.	DATE	REVISION	CHECKED	DESIGN	CHECK	APPROVAL
				黄丽红	潘秀丽	孙恩国

SHANDONG BOAM ELECTRIC CO



SPECIFICATION

CUSTOMER	GLOBALTEK(SUZHOU)	PART NAME	TRANSFORMER			
MODEL NO.	PQ3220	PART NO.	320-02013010			
3 ELECTRICAL CHARACTERISTICS						
NO.	ITEM	TERMINAL	SPECIFICATION	REMARKS		
1	INDUCTANCE	2-4	300 μ H \pm 5%	HIOKI 3531 Z HITESTER (1KHz,0.25V)		
2	LEAKAGE INDUCTANCE	2-4	25 μ H MAX (SHORT OTHER PINS)			
3	DC RESISTANCE	2-4	300m Ω MAX	HIOKI 3220 m Ω Hi TESTER TEMPERATURE: 20 $^{\circ}$ c		
4	DIELECTRIC WITHSTAND VOLTAGE	PRI-SEC	AC 4.0KV 1S	HPT-50100Z PUNCTURE TESTER: 5mA		
		COIL—CORE	AC2.0KV 1S			
SPEC NO.	KF-10121301-A	DATE	2010.12.13	SHEET NO.	3	
NO.	DATE	REVISION	CHECKED	DESIGN	CHECK	APPROVAL
				黄丽红	潘秀丽	孙恩国

SHANDONG BOAM ELECTRIC CO.,LTD



SPECIFICATION

CUSTOMER		受控文件 GLOBTEK(SUZHOU)		PART NAME	TRANSFORMER	
MODEL NO.		发行章 Q3220		PART NO.	320-02013010	
4. WINDING SPECIFICATION						
NO	PIN NO. (S-F) S:START, F:FINISH	WIRE	TURNS	WINDING METHOD		
N1	(2) — (3)	2UEW ϕ 0.40	17	SOLENOID WINDING		
INSULATION: POLYESTER TAPE t=0.025mm, w=9.5mm, 2LAYER						
N2	(5) — —	COPPER TAPE 0.05T*7+TAPE	0.9	SOLENOID WINDING		
INSULATION: POLYESTER TAPE t=0.025mm, w=9.5mm, 2LAYER						
N3	(9) — (7)	TEX ϕ 0.50*2	5	SOLENOID WINDING		
INSULATION: POLYESTER TAPE t=0.025mm, w=9.5mm, 1LAYER						
N4	(9) — (10)	TEX ϕ 0.18	15	SOLENOID WINDING		
INSULATION: POLYESTER TAPE t=0.025mm, w=9.5mm, 1LAYER						
N5	(11) — (8)	TEX ϕ 0.50	3	BIFILAR		
	(8) — (12)	TEX ϕ 0.50	3	SOLENOID WINDING		
INSULATION: POLYESTER TAPE t=0.025mm, w=9.5mm, 2LAYER						
N6	(5) — —	COPPER TAPE 0.05T*7+TAPE	0.9	SOLENOID WINDING		
INSULATION: POLYESTER TAPE t=0.025mm, w=9.5mm, 2LAYER						
N7	(3) — (4)	2UEW ϕ 0.40	15	SOLENOID WINDING		
INSULATION: POLYESTER TAPE t=0.025mm, w=9.5mm, 1LAYER						
N8	(5) — (6)	2UEW ϕ 0.22*2	6	SOLENOID WINDING		
INSULATION:TAPE t=0.025mm, w=9.5mm,3LAYER						
CORE FIXING :POLYESTER TAPE t=0.025mm, w=13.0mm, 3 Ts						
INSULATION:TAPE t=0.025mm, w=15mm,2LAYER						
	(5) -	0.05/10.0 mm,COPER+TAPE	1			
INSULATION:TAPE t=0.025mm, w=15mm,3LAYER						
	(5) --	0.05/10.0 mm,COPER+TAPE	1			
CORE INSULATION: POLYESTER TAPE t=0.025mm, w=26mm, 3 LAYER						
SPEC NO.	KF-10121301-A	DATE	2010.12.13	SHEET NO.	4	
NO.	DATE	REVISION	CHECKED	DESIGN	CHECK	APPROVAL
				黄丽红	潘秀丽	孙恩国

SHANDONG BOAM ELECTRIC CO.,LTD



SPECIFICATION

CUSTOMER	2011.5.26 GLOBTEK(SUZHOU)	PART NAME	TRANSFORMER
MODEL NO.	PQ3220	PART NO.	320-02013010

5. INTERNAL CONSTRUCTION

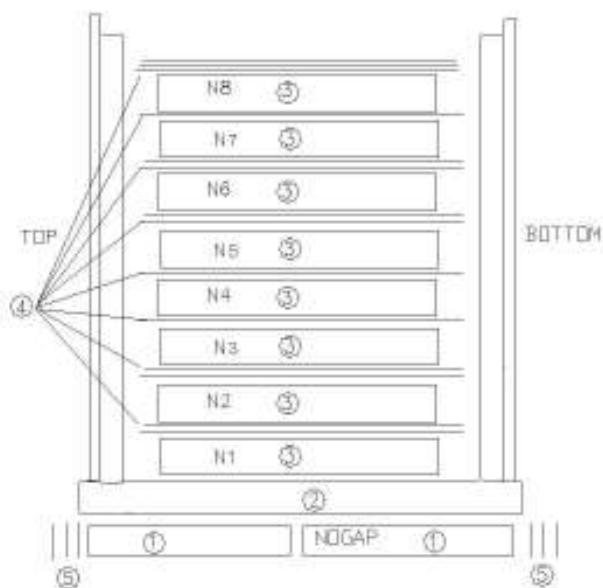

SPEC NO.	KF-10121301-A	DATE	2010.12.13	SHEET NO.	5	
NO.	DATE	REVISION	CHECKED	DESIGN	CHECK	APPROVAL
				黄丽红	潘秀丽	孙恩国

SHANDONG BOAM ELECTRIC CO.,LTD



SPECIFICATION

CUSTOMER	GLOBTEK(SUZHOU)	PART NAME	TRANSFORMER			
MODEL NO.	PQ3220	PART NO.	320-02013010			
6. LIST OF MATERIALS						
NO.	COMPONENT	MATERIALS	MANUFACTURES	REMARKS		
1	CORE	PQ3220 PC40	NAN JING JINNING CO.,LTD OR EQUIR	-		
2	BOBBIN	PHENOLIC PQ3220, 12PIN	CHANGCHUN PLASTIC	E59481 (S)		
3	WIRE	2UEW Φ0.22 2UEW Φ0.40 TEX Φ0.18 TEX Φ0.50	DONG YANG ELECTRONICS CO.,LTD OR EQUIR SUZHOU ASIA PACIFIC ELECTRONICS CO.,LTD OR EQUIR	E102761(S) E214423		
4	INSULATION TAPE	POLYESTER TAPE 0.025×9.5mm 0.025×15.0mm	JINGJIANG PRESSURESENSITIVE GLUE FTY OR EQUIR	E165111 (N)		
5	CORE FIXING TAPE	POLYESTER TAPE 0.025×13mm 0.025×26mm 0.025×28mm				
6	COPPER TAPE	0.05×7.0mm 0.05×10.0mm	TAEHWA INDUSTRIAL CO	-		
7	VARNISH	319-5F	JIANG YIN DENG FENG OR EQUIR	E236421		
8	TUBE	TEFLON	SHENZHEN CHANGBAO SPECIAL PLASTIC CO.,LTD OR EQUIR	E180908		
SPEC NO.	KF-10121301-A	DATE	2010.12.13	SHEET NO.	7	
NO.	DATE	REVISION	CHECKED	DESIGN	CHECK	APPROVAL
				黄丽红	潘秀丽	孙恩国

SHANDONG BOAM ELECTRIC CO.,LTD

SPECIFICATION

CUSTOMER	BOBTEK(SUZHOU)	PART NAME	TRANSFORMER
MODEL NO: 2011.5.26	PQ3220	PART NO.	320-02013010

受控文件
版本号

* UL YELLOW CARD

1) BOBBIN

Component-Plastics

CHANG CHUN PLASTICS CO LTD **E59481 (S)**

T-355J	BK	0.82	94V-0	150	150	150	(C-cont. from B card)				
		0.80	94V-0	150	150	150	1	0	2	6	3
		1.00	94V-0	150	150	150	1	0	2	6	3
T359J	BK, BN	0.79	94HB	150	150	150	1	0	4	7	4
		1.57	94HB	150	150	150	1	0	4	7	4
T373J	BK, BN	1.00	94V-1	150	150	150	2	0	3	6	4
	NC	1.00	94V-0	150	150	150	2	0	3	6	4
	(S)	2.00	94V-0	150	150	150	1	0	3	6	4
T375J	BK, BN	0.79	94V-0	150	150	150	1	0	4	5	4
		1.58	94V-0	150	150	150	0	0	4	5	4
		3.17	94V-0	150	150	150	0	0	4	5	4
T377J	BK	0.79	94HB	150	150	150	2	0	4	7	4
		1.58	94HB	150	150	150	1	0	4	7	4
		3.17	94HB	150	150	150	0	0	4	7	4

Report: January 6, 1976.

Replaces E59481C dated February 7, 1989. (Cont. on C1 card)

262854001 N7047 **Underwriters Laboratories Inc.®** D11/0018965

2) WIRE

DONG YANG ELECTRONICS IND. CO., LTD. **E102761 (S)**

660-1 BANWOL-RU TALAN-EUB Hwasung-Gun
KYUNGGI-DO KOREA

Mil Dsg	IC	Coat Typ	ANSI type	TI
ALEW	Polyester-imide	Polyamide-imide	MW35	200
EW	Polyester-imide	Polyamide	MW30	180
NY-EIW	Polyester-imide	Polyamide	MW70	180
NY-PEW	Polyester	Polyamide	MW24	155
NY-PEW/FI	Polyester	Polyamide	MW24	155
NY-UEW	Polyurethane	Polyamide	MW28	130
UEW	Polyurethane	-	MW15	130

Marking: Company name or "E102761" and material designation of marked designation on package of reel and Recognized Component Mark.

SHANGHAI ASIA PACIFIC ELECTRIC CO LTD **E214423**

2525 DAYIE RD WUCIAO FENGXIAN 201402 SHANGHAI, CHINA

Mil Dsg	Coat Type		ANSI Type	Temp Class
	BC	OC		
EIW	Polyester-imide	—	MW30	180
UEW	Polyurethane	—	MW82	200
			MW79	155#
PEW	Polyester	—	MW75	130#
			MW5	155
PEW/N	Polyester	Nylon	(@)	200
			MW76#	180
			MW24#	155

@-Non-ANSI type.
#-Additional consideration is needed before used in system thermal aging.
Marking: Company name and material designation on package or reel, and Recognized Component Mark.

SPEC NO.	KF-10121301-A	DATE	2010.12.13	SHEET NO.	8
NO.	DATE	REVISION	CHECKED	DESIGN	CHECK
				黄丽红	潘秀丽
					孙恩国

SHANDONG BOAM ELECTRIC CO.,LTD



SPECIFICATION

CUSTOMER	2011.5.26 GLOBTEK (SUZHOU)	PART NAME	TRANSFORMER
MODEL NO.	受控文件 PG3220 发行章	PART NO.	320-02013010
<p>FURUKAWA ELECTRIC CO.,LTD E157568(S) HIRETSUKA MAGNET WIRE WORKS 1-9 HIGASHI YAHATA 5-CHOME HIRATSUKA, KANGAWA-KEN 254 JAPAN</p> <p>Tripia insulated winding wire providing reinforced, class 105 insulating in transformer and similar wound nonmoving components. <u>Cat No. TEX-EA</u></p>			
<p>3) INSULATION TAPE</p> <p>OANZ2 January 31, 2000 Insulating Tape - Component JINGJIANG PRESSURE SENSITIVE GLUE FTY E165111 86 HENG GANG NORTH RD JINGJIANG, JIANGSU 214500 CHINA</p> <p>Nonwoven cloth/polyethylene terephthalate film tape, Cat. No. WF with suffixes, rated 130 C*(a). Polyethylene terephthalate film tape, Cat. No. CT with suffixes, rated 130 C*(c). Polyethylene terephthalate film tape, Cat. No. PZ with additional suffixes, rated 130 C*(b). *Complies with flame retardant requirements when so marked. (a) Comparative Tracking Index (CTI)% performance indicates material Group II, PLC=1, CTI equal to or greater than 400 but less than 600 v. (b) Comparative Tracking Index (CTI)% performance indicates material Group IIIa, PLC=2, CTI equal to or greater than 250 but less than 400 v. (c) Comparative Tracking Index (CTI)% performance indicates material Group I, PLC=0, CTI equal to or greater than 600 v. %The CTI test was conducted per IEC 112 and the assigned level is based on the testing of both film and adhesive sides. Marking: Company name or E165111 and catalog designation printed on the carton, wrapper or core.</p> <p>4/12/2000 Underwriters Laboratories Inc. Card 1 of 2</p>			
SPEC NO.	KF-10121301-A	DATE	2010.12.13
		SHEET NO.	9
NO.	DATE	REVISION	CHECKED
			DESIGN
			CHECK
			APPROVAL
			黄丽红 潘秀丽 孙恩国

SHANDONG BOAM ELECTRIC CO.,LTD