



# TEST REPORT

**Reference No.**..... : WTX23X10233369E002  
**Applicant** ..... : GlobTek, Inc.  
**Address** ..... : 186 Veterans Dr. Northvale, NJ 07647 USA  
**Manufacturer** ..... : 1: GlobTek, Inc.2: GlobTek (Suzhou) Co., Ltd  
1: 186 Veterans Dr. Northvale, NJ 07647 USA  
**Address** ..... : 2: Building 4, No. 76, Jin Ling East Rd., Suzhou Industrial Park, Suzhou,  
JiangSu 215021, China  
**Product Name** ..... : ITE/Medical Power Supply  
**Model No.**..... : GT(M or -)21097-X-Y.Y series  
**Standards** ..... : **EN 60601-1-2:2015+A1:2021**  
**Date of Receipt sample** .... : 2023-12-07  
**Date of Test**..... : 2023-12-07 to 2023-12-11  
**Date of Issue** ..... : 2023-12-11  
**Test Report Form No.** ..... : WTX\_EN 60601\_1\_2\_2015\_B  
**Test Result**..... : **Pass**

**Remarks:**

The results shown in this test report refer only to the sample(s) tested, this test report cannot be reproduced, except in full, without prior written permission of the company. The report would be invalid without specific stamp of test institute and the signatures of approver.

**Prepared By:**

**Waltek Testing Group (Shenzhen) Co., Ltd.**

Address: 1/F., Room 101, Building 1, Hongwei Industrial Park, Liuxian 2nd Road,  
Block 70 Bao'an District, Shenzhen, Guangdong, China

Tel.: +86-755-33663308 Fax.: +86-755-33663309 Email: sem@waltek.com.cn

Tested by:

Toby Zhang

Approved by:

Silin Chen



## **TABLE OF CONTENTS**

<b>1. GENERAL INFORMATION</b> .....	<b>5</b>
1.1 PRODUCT DESCRIPTION FOR EQUIPMENT UNDER TEST (EUT) .....	5
1.2 TEST STANDARDS.....	6
1.3 TEST METHODOLOGY .....	6
1.4 EUT SETUP AND OPERATION MODE .....	7
1.5 PERFORMANCE CRITERIA FOR EMS.....	8
1.6 TEST EQUIPMENT LIST AND DETAILS .....	9
<b>2. SUMMARY OF TEST RESULTS</b> .....	<b>12</b>
<b>3. CONDUCTED EMISSION</b> .....	<b>13</b>
3.1 MEASUREMENT UNCERTAINTY .....	13
3.2 BASIC TEST SETUP BLOCK DIAGRAM .....	13
3.3 ENVIRONMENTAL CONDITIONS.....	13
3.4 SUMMARY OF TEST RESULTS.....	13
<b>4. RADIATED EMISSION</b> .....	<b>18</b>
4.1 MEASUREMENT UNCERTAINTY .....	18
4.2 BASIC TEST SETUP BLOCK DIAGRAM .....	18
4.3 CORRECTED AMPLITUDE & MARGIN CALCULATION.....	19
4.4 ENVIRONMENTAL CONDITIONS .....	19
4.5 SUMMARY OF TEST RESULTS.....	19
<b>5. HARMONIC CURRENT EMISSIONS</b> .....	<b>24</b>
5.1 TEST PROCEDURE .....	24
5.2 TEST STANDARDS .....	24
5.3 ENVIRONMENTAL CONDITIONS .....	24
5.4 BASIC TEST SETUP BLOCK DIAGRAM .....	24
5.5 HARMONIC CURRENT EMISSIONS TEST DATA.....	24
<b>6. VOLTAGE FLUCTUATION FLICKER</b> .....	<b>25</b>
6.1 TEST PROCEDURE .....	25
6.2 TEST STANDARDS.....	25
6.3 ENVIRONMENTAL CONDITIONS .....	25
6.4 BASIC TEST SETUP BLOCK DIAGRAM .....	25
6.5 VOLTAGE FLUCTUATION AND FLICKER TEST DATA.....	25
<b>7. ELECTROSTATIC DISCHARGES (ESD)</b> .....	<b>27</b>
7.1 TEST PROCEDURE .....	27
7.2 TEST PERFORMANCE.....	27
7.3 ENVIRONMENTAL CONDITIONS .....	27
7.4 BASIC TEST SETUP BLOCK DIAGRAM .....	27
7.5 ELECTROSTATIC DISCHARGE IMMUNITY TEST DATA .....	28
<b>8. CONTINUOUS RF ELECTROMAGNETIC FIELD DISTURBANCES (RS)</b> .....	<b>29</b>
8.1 TEST PROCEDURE .....	29
8.2 TEST PERFORMANCE.....	29
8.3 ENVIRONMENTAL CONDITIONS .....	29
8.4 BASIC TEST SETUP BLOCK DIAGRAM .....	29
8.5 CONTINUOUS RADIATED DISTURBANCES TEST DATA.....	30
<b>9. ELECTRICAL FAST TRANSIENTS (EFT)</b> .....	<b>31</b>
9.1 TEST PROCEDURE .....	31
9.2 TEST PERFORMANCE.....	31
9.3 ENVIRONMENTAL CONDITIONS .....	31
9.4 BASIC TEST SETUP BLOCK DIAGRAM .....	31
9.5 ELECTRICAL FAST TRANSIENTS TEST DATA.....	32
<b>10. SURGES</b> .....	<b>33</b>
10.1 TEST PROCEDURE .....	33
10.2 TEST PERFORMANCE .....	33



Reference No.: WTX23X10233369E002

10.3 ENVIRONMENTAL CONDITIONS.....	33
10.4 BASIC TEST SETUP BLOCK DIAGRAM .....	33
10.5 SURGE TEST DATA .....	34
<b>11. CONTINUOUS INDUCED RF DISTURBANCES (C/S).....</b>	<b>35</b>
11.1 TEST PROCEDURE .....	35
11.2 TEST PERFORMANCE.....	35
11.3 ENVIRONMENTAL CONDITIONS .....	35
11.4 BASIC TEST SETUP BLOCK DIAGRAM.....	35
11.5 CONTINUOUS CONDUCTED DISTURBANCES TEST DATA.....	36
<b>12. POWER-FREQUENCY MAGNETIC FIELDS (PFMF).....</b>	<b>37</b>
12.1 TEST PROCEDURE .....	37
12.2 TEST PERFORMANCE .....	37
12.3 ENVIRONMENTAL CONDITIONS .....	37
12.4 BASIC TEST SETUP BLOCK DIAGRAM .....	37
12.5 POWER-FREQUENCY MAGNETIC FIELD TEST DATA .....	37
<b>13. VOLTAGE DIPS AND INTERRUPTIONS.....</b>	<b>38</b>
13.1 TEST PROCEDURE .....	38
13.2 TEST PERFORMANCE .....	38
13.3 ENVIRONMENTAL CONDITIONS .....	38
13.4 BASIC TEST SETUP BLOCK DIAGRAM .....	38
13.5 VOLTAGE DIPS AND INTERRUPTIONS TEST DATA .....	38
<b>EXHIBIT 1 - PRODUCT LABELING.....</b>	<b>39</b>
PROPOSED CE LABEL FORMAT.....	39
PROPOSED LABEL LOCATION ON EUT.....	39
<b>EXHIBIT 2 - EUT PHOTOGRAPHS .....</b>	<b>40</b>
<b>EXHIBIT 3 - TEST SETUP PHOTOGRAPHS.....</b>	<b>45</b>

**WALTERK**



## Report version

Version No.	Date of issue	Description
Rev.00	2023-12-11	Original
/	/	/

# WALTEK



## 1. GENERAL INFORMATION

### 1.1 Product Description for Equipment Under Test (EUT)

General Description of EUT	
Product Name:	ITE/Medical Power Supply
Trade Name:	
Model No.:	GT(M or -)21097-X-Y.Y series
Adding Model(s):	/
<p><i>Note: The test data is gathered from a production sample, provided by the manufacturer.</i></p> <p><i>GT(M or -)21097-X-Y.Y</i></p> <p><i>Where "M" or "-" for market identification and not related to safety.</i></p> <p><i>"X" denotes the standard output power and voltage, which can be 2003, 3005, 4509, 5012, 5015, 5018, 5024 or 5048, the former two numbers of figures indicate max. output power, 50W max. and the latter two numbers of figures indicate standard model output voltage.</i></p> <p><i>"-Y.Y" is optional variable or blank for specifying output voltage deviation from standard model; which means subcontracting volts from standard output voltage in 0.1V increments or blank; 0.1min.to 23.9 max., actual voltage range is 3.3-48V only.</i></p>	

Technical Characteristics of EUT	
Rated Voltage:	AC 100-240V
Rated Current:	1.6-0.5A
Rated Power:	/
Power Adaptor Model:	GTM21097-5048 Input: 100-240V, 50-60Hz or 50/60Hz, 1.6A MAX Output: 48V=1A, 48W
Highest Internal Frequency:	Below 108MHz
Classification of Equipment:	Class B



## 1.2 Test Standards

The tests were performed according to following standards:

**EN 60601-1-2:2015+A1:2021:**Medical electrical equipment – Part 1-2: General requirements for basic safety and essential performance – Collateral standard: Electromagnetic compatibility – Requirements and tests.

**Maintenance of compliance** is the responsibility of the manufacturer. Any modification of the product maybe which result in lowering the emission/immunity should be checked to ensure compliance has been maintained.

## 1.3 Test Methodology

All measurements contained in this report were conducted with the standards IEC 60601-1-2 for Medical electrical equipment – Part 1-2: General requirements for basic safety and essential performance – Collateral standard:Electromagnetic compatibility – Requirements and tests.

# WALTEK



## 1.4 EUT Setup and Operation Mode

The equipment under test (EUT) was configured to measure its highest possible emission/immunity level. The test modes were adapted according to the operation manual for use, more detailed description as follows:

Test Mode List			
Test Mode	Description	Remark	Power Supply Mode
TM1	Working Mode	Output is connected to the Load(48R)	AC 230V/50Hz
TM2	Working Mode	Output is connected to the Load(48R)	AC 120V/60Hz

EUT Cable List and Details				
Cable Description	Length (m)	Shielded/Unshielded	With / Without Ferrite	With / Without Chip
DC cable	1.9	Shielded	With	Without

Special Cable List and Details				
Cable Description	Length (m)	Shielded/Unshielded	With / Without Ferrite	With / Without Chip
AC Cable	1.0	Unshielded	Without	Without

Auxiliary Equipment List and Details			
Description	Manufacturer	Model	Serial Number
Load	/	/	/



## 1.5 Performance Criteria for EMS

All the test data has been collected, reduced, and analyzed within this report in accordance with Immunity requires the following as specific performance criteria:

- A. The apparatus shall continue to operate as intended during and after the test. The manufacturer specifies some minimum performance level. The performance level may be specified by the manufacturer as a permissible loss of performance.
- B. The apparatus shall continue to operate as intended after the test. This indicates that the EUT does not need to function at normal performance levels during the test, but must recover. Again some minimal performance is defined by the manufacturer. No change in operating state or loss of data is permitted.
- C. Temporary loss of function is allowed. Operation of the EUT may stop as long as it is either automatically reset or can be manually restored by operation of the controls.

# WALTEK





## 1.6 Test Equipment List and Details

Description	Manufacturer	Model	Serial No.	Cal. Date	Due. Date
<input type="checkbox"/> Chamber A: Below 1GHz					
Spectrum Analyzer	Rohde & Schwarz	FSP30	836079/035	2023-02-25	2024-02-24
EMI Test Receiver	Rohde & Schwarz	ESVB	825471/005	2023-02-25	2024-02-24
Trilog Broadband Antenna	Schwarz beck	VULB9163	9163-333	2023-03-20	2026-03-19
Loop Antenna	Schwarz beck	FMZB 1516	9773	2021-03-20	2024-03-19
Amplifier	HP	8447F	2805A03475	2023-02-25	2024-02-24
EMI Test Software (Radiated Emission A)	Farad	EZ-EMC	RA-03A1 (1.1.4.2)	/	/
<input type="checkbox"/> Chamber A: Above 1GHz					
Amplifier	C&D	PAP-1G18	2002	2023-02-25	2024-02-24
Horn Antenna	ETS	3117	00086197	2021-03-19	2024-03-18
EMI Test Software (Radiated Emission A)	Farad	EZ-EMC	RA-03A1 (1.1.4.2)	/	/
<input checked="" type="checkbox"/> Chamber B: Below 1GHz					
Trilog Broadband Antenna	Schwarz beck	VULB9163(B)	9163-635	2021-04-09	2024-04-08
Amplifier	Agilent	8447D	2944A10457	2023-02-25	2024-02-24
EMI Test Receiver	Rohde & Schwarz	ESPI	101391	2023-02-25	2024-02-24
EMI Test Software (Radiated Emission B)	Farad	EZ-EMC	RA-03A1 (1.1.4.2)	/	/
<input type="checkbox"/> Chamber C: Below 1GHz					
EMI Test Receiver	Rohde & Schwarz	ESIB 26	100401	2023-02-25	2024-02-24
Trilog Broadband Antenna	Schwarz beck	VULB 9168	1194	2021-05-28	2024-05-27
Amplifier	HP	8447F	2944A03869	2023-02-25	2024-02-24
EMI Test Software (Radiated Emission C)	Farad	EZ-EMC	RA-03A1-2 (1.1.4.2)	/	/
<input type="checkbox"/> Chamber C: Above 1GHz					
Horn Antenna	POAM	RTF-118A	1820	2023-03-10	2026-03-09
Amplifier	Tonscend	TAP01018050	AP22E806235	2023-02-25	2024-02-24
EMI Test Software (Radiated Emission C)	Farad	EZ-EMC	RA-03A1-2 (1.1.4.2)	/	/
<input checked="" type="checkbox"/> Conducted Room 1#					



Reference No.: WTX23X10233369E002

EMI Test Receiver	Rohde & Schwarz	ESPI	101611	2023-02-25	2024-02-24
Pulse Limiter	Rohde & Schwarz	ESH3-Z2	100911	2023-02-25	2024-02-24
AC LISN	Schwarz beck	NSLK8126	8126-279	2023-02-25	2024-02-24
8-WIRE ISN	Schwarz beck	8158	CAT3-8158-0059	2023-02-25	2024-02-24
8-WIRE ISN	Schwarz beck	8158	CAT5-8158-0117	2023-02-25	2024-02-24
EMI Test Software (Conducted Emission Room 1#)	Farad	EZ-EMC	3A1*CE-RE 1.1.4.3	/	/
<input type="checkbox"/> Conducted Room 2#					
EMI Test Receiver	Rohde & Schwarz	ESPI	101259	2023-02-25	2024-02-24
LISN	Rohde & Schwarz	ENV 216	100097	2023-02-25	2024-02-24
EMI Test Software (Conducted Emission Room 2#)	SKET	EMC-I	1.3.0.2	/	/
<input checked="" type="checkbox"/> Harmonics &Flicker					
Digital Power Analyzer	California Instrument	CTS	72831	2023-02-25	2024-02-24
Power Source	California Instrument	5001IX-CTS-400	60077	2023-02-25	2024-02-24
Test Software (Harmonics &Flicker)	AMETEK	CTS4	4.30	/	/
<input checked="" type="checkbox"/> Electrostatic discharges					
ESD Generator	LIONCEL	ESD-203B	0170901	2023-03-14	2024-03-13
<input checked="" type="checkbox"/> Power-frequency magnetic field (PFMF)					
PMF Generator	LIONCEL	PMF-801C-C	0171101	2023-02-25	2024-02-24
PMF Antenna	LIONCEL	PMF-801C-A	0180302	2023-02-25	2024-02-24
Instantaneous PMF Generator Module	LIONCEL	PMF-801C-T	0171001	2023-02-25	2024-02-24
<input checked="" type="checkbox"/> Electronic fast transient(EFT)/Surges/Dips					
Transient 2000	EMC PARTNER	TRA2000	836	2023-02-25	2024-02-24
Couple Clamp	EMC PARTNER	CN-EFT1000	513	2023-02-25	2024-02-24
<input checked="" type="checkbox"/> Radio frequency, continuous conducted (C/S)					
CONDUCTED IMMUNITY TEST SYSTEM	FRANKONIA	CIT-10/75	126B1247/2013	2023-02-25	2024-02-24
Attenuator	EMTEST	MA-5100/6BF2	1009	2023-02-25	2024-02-24
CDN	Luthi	L-801M2/M3	2665	2023-02-25	2024-02-24
CDN	LIONCEL	CDN-T8	0210401	2023-02-25	2024-02-24
EM Clamp	TESEQ	KEMZ801A	45028	2023-02-25	2024-02-24
Test Software (Radio frequency,	SKET	EMC-S	V1.4.0.16	/	/



Continuous conducted)					
<input checked="" type="checkbox"/> Radio frequency electromagnetic Field (R/S)					
Signal Generator	HP	8665B	3438A00604	2023-02-25	2024-02-24
Power Sensor	Agilent	E9301A	MY52450001	2023-02-25	2024-02-24
Power Sensor	Agilent	E9304A	MY55081055	2023-02-25	2024-02-24
RF Power Amplifier	MicoTop	MPA-80-1000-250	MPA1906239	2023-02-25	2024-02-24
RF Power Amplifier	MicoTop	MPA-1000-6000-100	MPA1906238	2023-02-25	2024-02-24
Antenna	SCHWARZBECK	STLP 9129	9129 114	/	/
Power Meter	Agilent	E4419B	GB42420578	2023-02-25	2024-02-24
Test Software (Radio frequency electromagnetic Field)	EMtrace	EM3	V1.2.6.2	/	/

# WALTEK



## 2. SUMMARY OF TEST RESULTS

Standards	Description of Test Item	Result
EN 60601-1-2	Conducted Disturbance	Compliant
	Radiated Disturbance	Compliant
	Harmonic Current Emission IEC 61000-3-2	Compliant
	Voltage Fluctuation and Flicker IEC 61000-3-3	Compliant
	Electrostatic Discharge Immunity in accordance with IEC 61000-4-2	Compliant
	Continuous Radiated Disturbances Immunity in accordance with IEC 61000-4-3	Compliant
	Electrical Fast Transient/Burst Immunity in accordance With IEC 61000-4-4	Compliant
	Surges Immunity in accordance with IEC 61000-4-5	Compliant
	Continuous Conducted Disturbances Immunity in accordance with IEC 61000-4-6	Compliant
	Power-frequency Magnetic Fields Immunity in accordance with IEC 61000-4-8	Compliant
	Voltage Dips/Interruptions Immunity in accordance with IEC 61000-4-11	Compliant



### 3. Conducted Emission

#### 3.1 Measurement Uncertainty

Base on NIS 81, The Treatment of Uncertainty in EMC Measurements, the best estimate of the uncertainty of any conducted emissions measurement:

Measurement uncertainty		
Parameter	Conditions	Uncertainty
Conducted Emissions	Conducted	9-150kHz $\pm 3.74\text{dB}$
		0.15-30MHz $\pm 3.34\text{dB}$

#### 3.2 Basic Test Setup Block Diagram

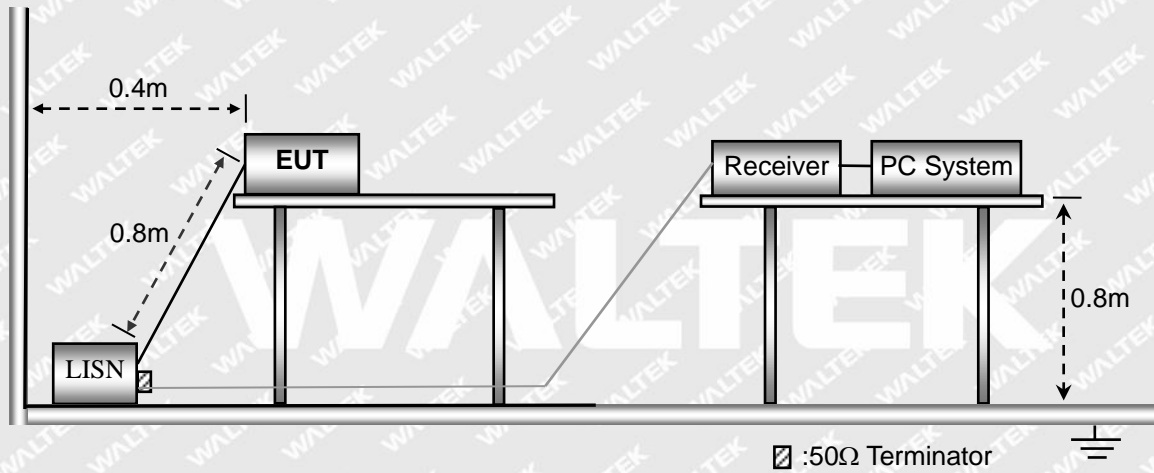

#### 3.3 Environmental Conditions

Temperature:	23.5 °C
Relative Humidity:	54 %
ATM Pressure:	998 mbar

#### 3.4 Summary of Test Results

Please find the results below:



Test mode:	TM1	Polarity:	Line
------------	-----	-----------	------

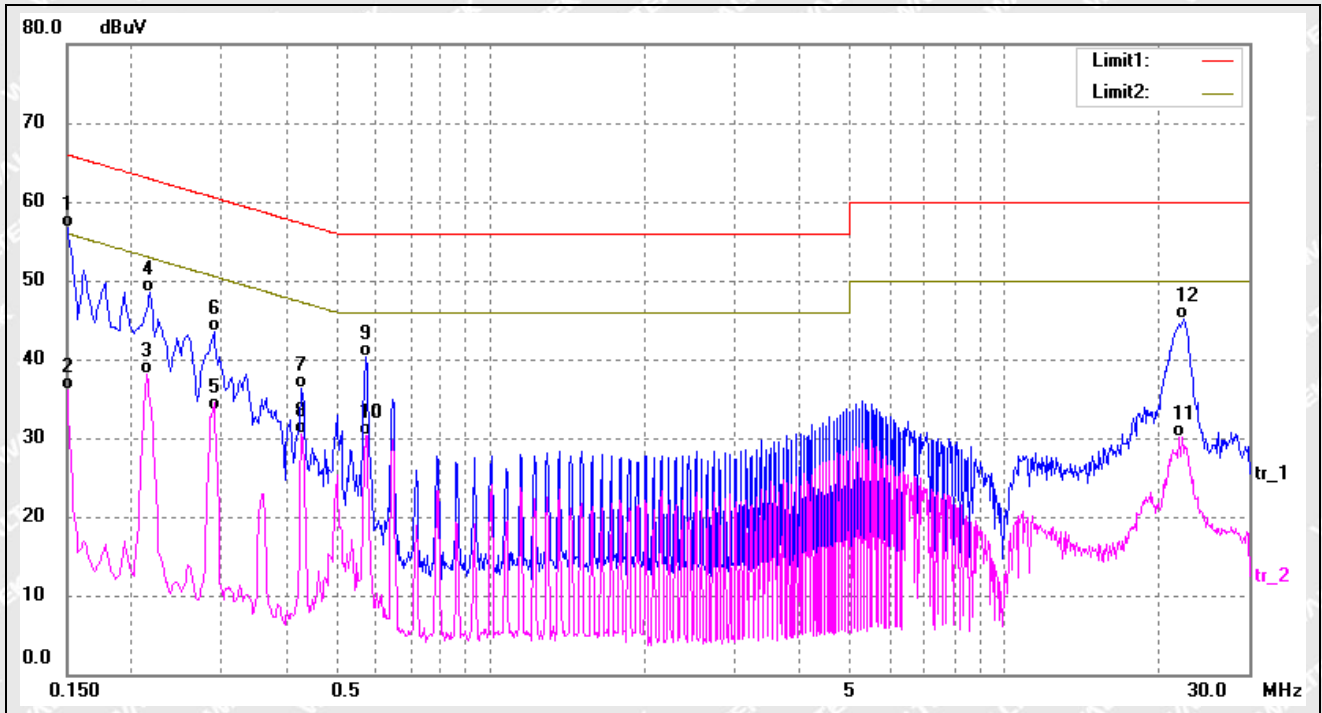

No.	Frequency (MHz)	Reading (dBuV)	Correct (dB)	Result (dBuV)	Limit (dBuV)	Margin (dB)	Detector
1*	0.1500	46.36	10.40	56.76	65.99	-9.23	QP
2	0.1500	25.71	10.40	36.11	55.99	-19.88	AVG
3	0.2140	27.68	10.38	38.06	53.04	-14.98	AVG
4	0.2180	38.06	10.37	48.43	62.89	-14.46	QP
5	0.2878	23.16	10.31	33.47	50.59	-17.12	AVG
6	0.2900	33.23	10.31	43.54	60.52	-16.98	QP
7	0.4300	26.03	10.25	36.28	57.25	-20.97	QP
8	0.4300	20.20	10.25	30.45	47.25	-16.80	AVG
9	0.5740	30.07	10.22	40.29	56.00	-15.71	QP
10	0.5740	20.18	10.22	30.40	46.00	-15.60	AVG
11	22.0540	19.69	10.34	30.03	50.00	-19.97	AVG
12	22.4140	34.67	10.34	45.01	60.00	-14.99	QP



Test mode:	TM1	Polarity:	Neutral
------------	-----	-----------	---------

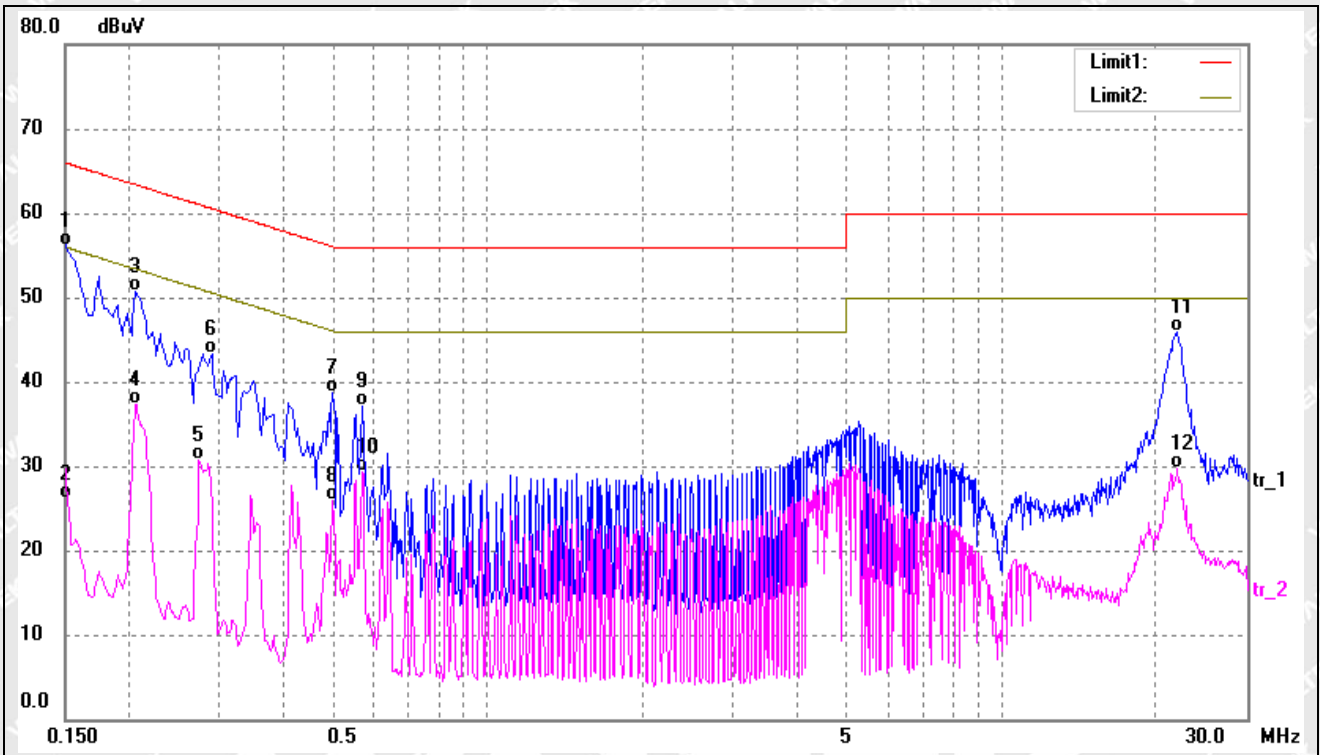

No.	Frequency (MHz)	Reading (dBuV)	Correct (dB)	Result (dBuV)	Limit (dBuV)	Margin (dB)	Detector
1*	0.1500	45.80	10.40	56.20	65.99	-9.79	QP
2	0.1500	15.61	10.40	26.01	55.99	-29.98	AVG
3	0.2060	40.31	10.38	50.69	63.36	-12.67	QP
4	0.2060	26.89	10.38	37.27	53.36	-16.09	AVG
5	0.2740	20.36	10.33	30.69	50.99	-20.30	AVG
6	0.2900	33.09	10.31	43.40	60.52	-17.12	QP
7	0.4980	28.46	10.23	38.69	56.03	-17.34	QP
8	0.4980	15.70	10.23	25.93	46.03	-20.10	AVG
9	0.5700	26.84	10.22	37.06	56.00	-18.94	QP
10	0.5700	19.14	10.22	29.36	46.00	-16.64	AVG
11	21.8700	35.56	10.35	45.91	60.00	-14.09	QP
12	22.0100	19.45	10.34	29.79	50.00	-20.21	AVG



Test mode:	TM2	Polarity:	Line
------------	-----	-----------	------

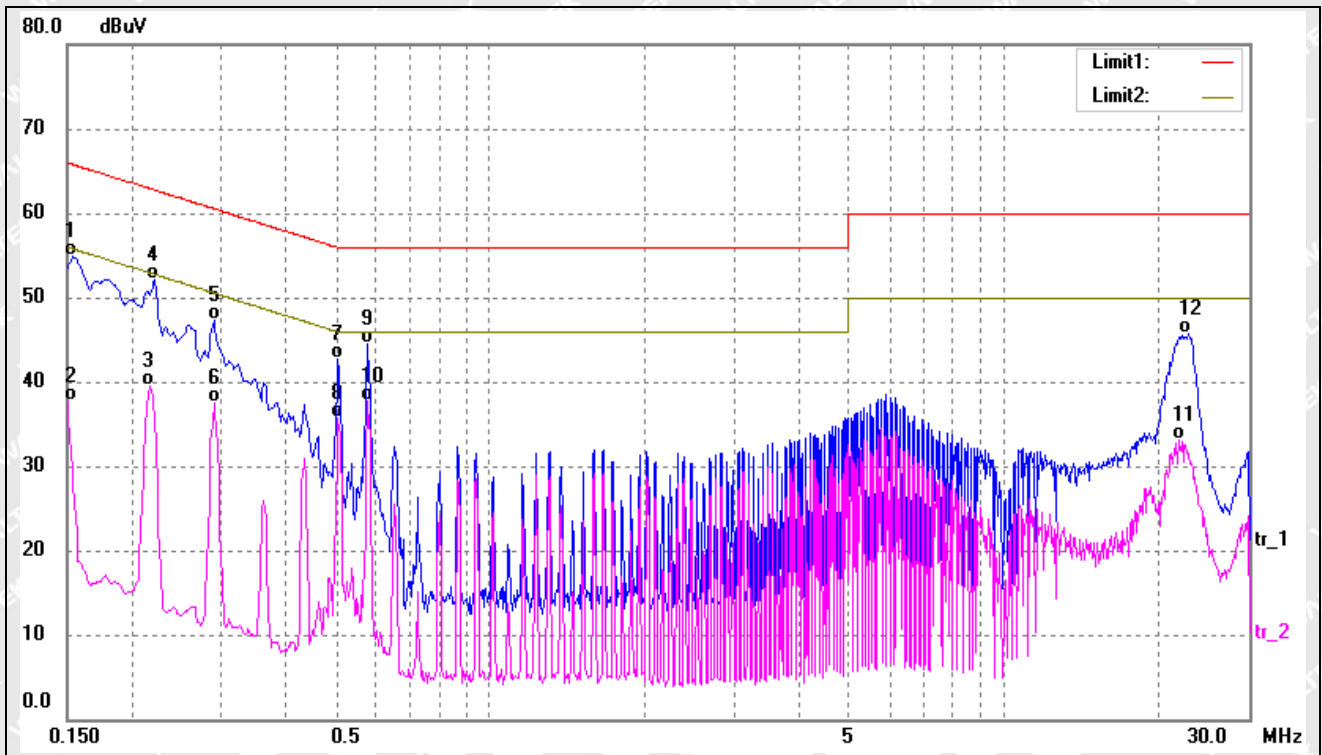

No.	Frequency (MHz)	Reading (dBuV)	Correct (dB)	Result (dBuV)	Limit (dBuV)	Margin (dB)	Detector
1	0.1539	44.51	10.41	54.92	65.78	-10.86	QP
2	0.1539	27.31	10.41	37.72	55.78	-18.06	AVG
3	0.2180	29.06	10.37	39.43	52.89	-13.46	AVG
4	0.2220	41.72	10.37	52.09	62.74	-10.65	QP
5	0.2900	37.06	10.31	47.37	60.52	-13.15	QP
6	0.2900	27.26	10.31	37.57	50.52	-12.95	AVG
7	0.5060	32.55	10.23	42.78	56.00	-13.22	QP
8	0.5060	25.48	10.23	35.71	46.00	-10.29	AVG
9	0.5780	34.27	10.22	44.49	56.00	-11.51	QP
10*	0.5780	27.47	10.22	37.69	46.00	-8.31	AVG
11	21.8540	22.66	10.35	33.01	50.00	-16.99	AVG
12	22.8660	35.37	10.33	45.70	60.00	-14.30	QP





Test mode:	TM2	Polarity:	Neutral
------------	-----	-----------	---------

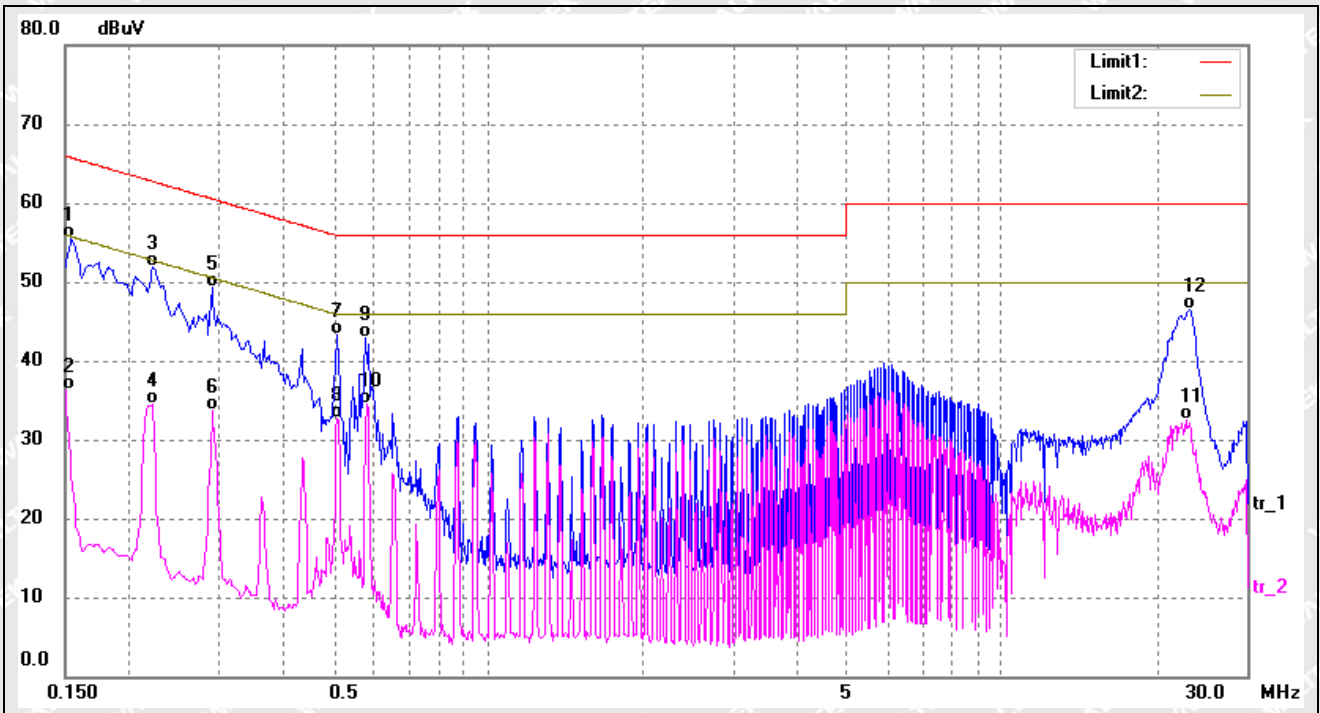

No.	Frequency (MHz)	Reading (dBuV)	Correct (dB)	Result (dBuV)	Limit (dBuV)	Margin (dB)	Detector
1*	0.1539	45.17	10.41	55.58	65.78	-10.20	QP
2	0.1539	25.93	10.41	36.34	55.78	-19.44	AVG
3	0.2220	41.61	10.37	51.98	62.74	-10.76	QP
4	0.2220	24.07	10.37	34.44	52.74	-18.30	AVG
5	0.2900	38.94	10.31	49.25	60.52	-11.27	QP
6	0.2900	23.42	10.31	33.73	50.52	-16.79	AVG
7	0.5100	33.09	10.23	43.32	56.00	-12.68	QP
8	0.5100	22.39	10.23	32.62	46.00	-13.38	AVG
9	0.5780	32.63	10.22	42.85	56.00	-13.15	QP
10	0.5820	24.25	10.22	34.47	46.00	-11.53	AVG
11	22.8180	22.19	10.33	32.52	50.00	-17.48	AVG
12	23.2540	36.21	10.32	46.53	60.00	-13.47	QP



## 4. Radiated Emission

### 4.1 Measurement Uncertainty

Base on NIS 81, The Treatment of Uncertainty in EMC Measurements, the best estimate of the uncertainty of any radiation emissions measurement:

Measurement uncertainty		
Parameter	Conditions	Uncertainty
Radiated Emissions	Radiated	30-200MHz $\pm 4.52\text{dB}$
		0.2-1GHz $\pm 5.56\text{dB}$
		1-6GHz $\pm 3.84\text{dB}$
		6-18GHz $\pm 3.92\text{dB}$

### 4.2 Basic Test Setup Block Diagram

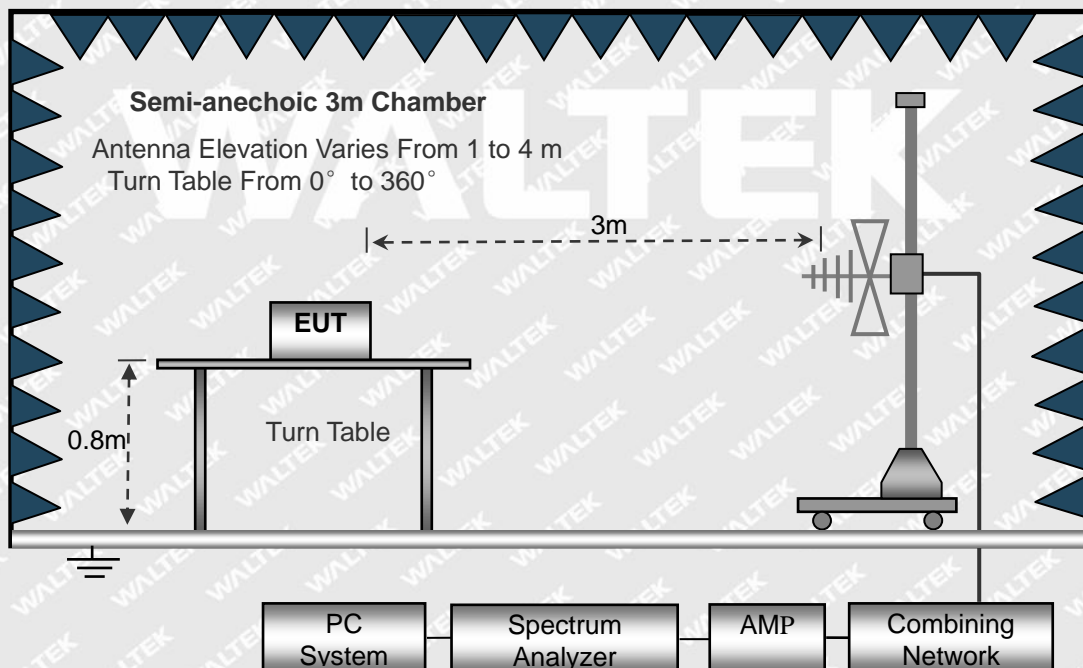



### 4.3 Corrected Amplitude & Margin Calculation

The Corrected Amplitude is calculated by adding the Antenna Factor and the Cable Factor, and subtracting the Amplifier Gain from the Amplitude reading. The basic equation is as follows:

$$\text{Corr. Ampl.} = \text{Indicated Reading} + \text{Correct Correct} = \text{Ant. Factor} + \text{Cable Loss} - \text{Ampl. Gain}$$

The "**Margin**" column of the following data tables indicates the degree of compliance with the applicable limit. For example, a margin of -6dB $\mu$ V means the emission is 6dB $\mu$ V below the maximum limit for Class B device. The equation for margin calculation is as follows:

$$\text{Margin} = \text{Corr. Ampl.} - \text{CISPR 11 Class B Limit}$$

### 4.4 Environmental Conditions

Temperature:	23.5 °C
Relative Humidity:	54 %
ATM Pressure:	998 mbar

### 4.5 Summary of Test Results

Please find the results below:



Test mode:	TM1	Polarity:	Horizontal
------------	-----	-----------	------------

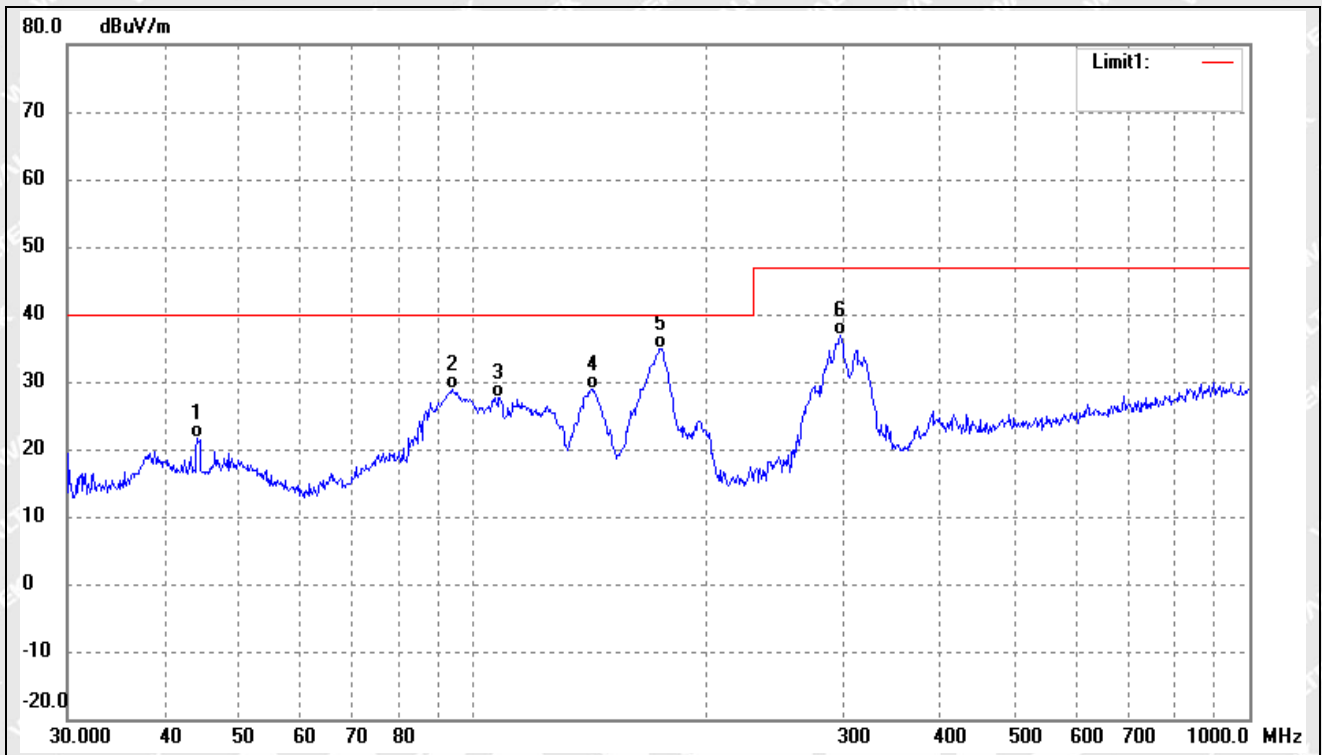

No.	Frequency (MHz)	Reading (dBuV/m)	Correct (dB/m)	Result (dBuV/m)	Limit (dBuV/m)	Margin (dB)	Remark
1	44.1202	32.56	-10.94	21.62	40.00	-18.38	QP
2	94.0979	41.30	-12.54	28.76	40.00	-11.24	QP
3	107.8877	40.13	-12.55	27.58	40.00	-12.42	QP
4	142.3243	43.95	-15.10	28.85	40.00	-11.15	QP
5	174.4241	48.97	-13.97	35.00	40.00	-5.00	QP
6	297.2241	45.29	-8.43	36.86	47.00	-10.14	QP



Test mode:	TM1	Polarity:	Vertical
------------	-----	-----------	----------



No.	Frequency (MHz)	Reading (dBuV/m)	Correct (dB/m)	Result (dBuV/m)	Limit (dBuV/m)	Margin (dB)	Remark
1	39.2991	42.84	-11.07	31.77	40.00	-8.23	QP
2	93.4402	45.06	-12.60	32.46	40.00	-7.54	QP
3	114.5146	47.36	-13.23	34.13	40.00	-5.87	QP
4	141.8262	50.39	-15.09	35.30	40.00	-4.70	QP
5	176.8878	45.83	-13.86	31.97	40.00	-8.03	QP
6	298.2681	41.45	-8.40	33.05	47.00	-13.95	QP



Test mode:	TM2	Polarity:	Horizontal
------------	-----	-----------	------------

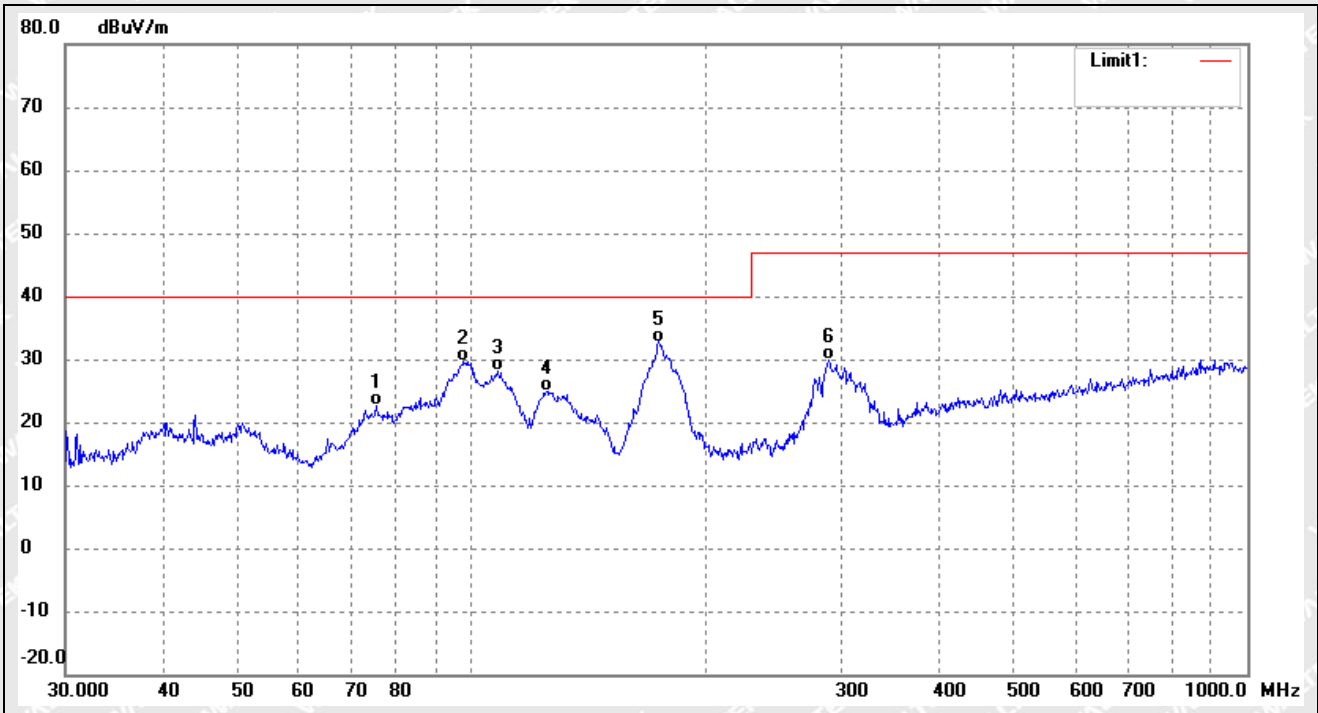

No.	Frequency (MHz)	Reading (dBuV/m)	Correct (dB/m)	Result (dBuV/m)	Limit (dBuV/m)	Margin (dB)	Remark
1	75.4464	37.88	-15.22	22.66	40.00	-17.34	QP
2	97.7983	41.96	-12.30	29.66	40.00	-10.34	QP
3	108.2667	40.60	-12.58	28.02	40.00	-11.98	QP
4	125.0066	39.28	-14.34	24.94	40.00	-15.06	QP
5	174.4241	46.72	-13.97	32.75	40.00	-7.25	QP
6	289.0021	38.72	-8.74	29.98	47.00	-17.02	QP



Test mode:	TM2	Polarity:	Vertical
------------	-----	-----------	----------

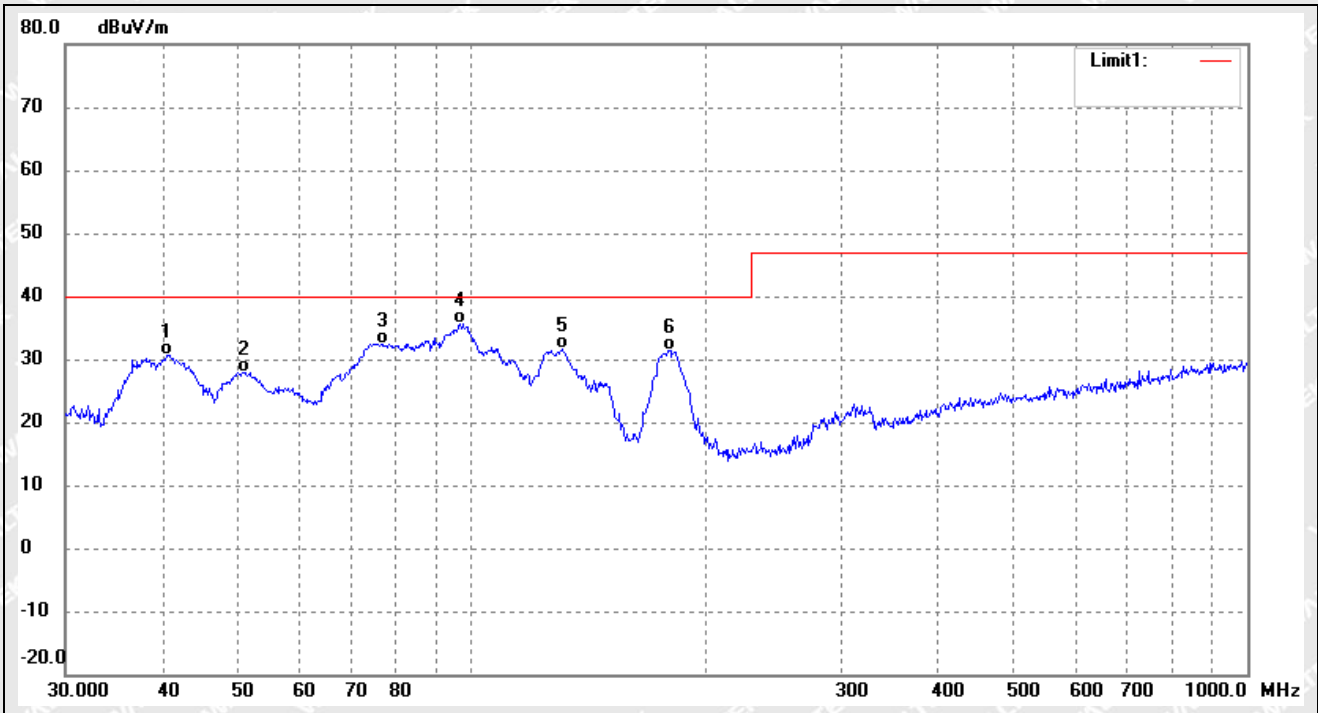

No.	Frequency (MHz)	Reading (dBuV/m)	Correct (dB/m)	Result (dBuV/m)	Limit (dBuV/m)	Margin (dB)	Remark
1	40.5591	41.61	-10.94	30.67	40.00	-9.33	QP
2	50.9420	39.06	-11.17	27.89	40.00	-12.11	QP
3	76.7808	47.73	-15.23	32.50	40.00	-7.50	QP
4	96.7749	48.10	-12.36	35.74	40.00	-4.26	QP
5	130.8369	46.30	-14.78	31.52	40.00	-8.48	QP
6	180.0165	45.20	-13.72	31.48	40.00	-8.52	QP



## 5. Harmonic Current Emissions

### 5.1 Test Procedure

Test is conducted under the description of IEC 61000-3-2.

### 5.2 Test Standards

IEC 61000-3-2, Clause 7.2 Limits for Class A equipment.

### 5.3 Environmental Conditions

Temperature:	23.5 °C
Relative Humidity:	53 %
ATM Pressure:	998 mbar

### 5.4 Basic Test Setup Block Diagram

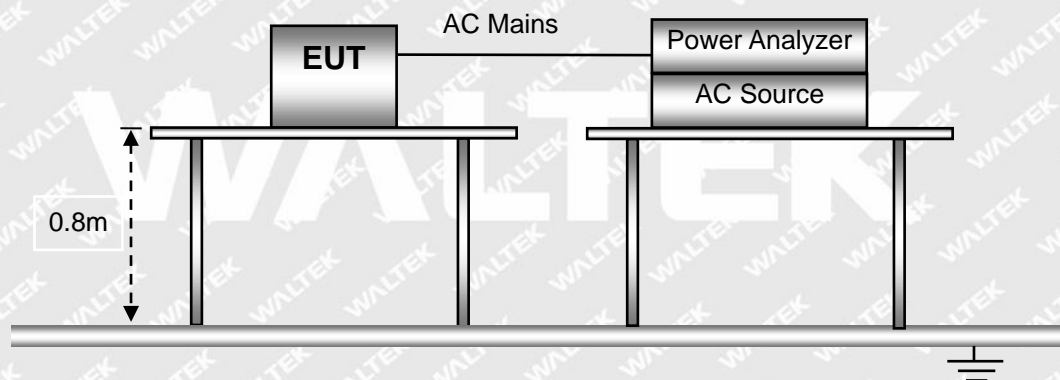

### 5.5 Harmonic Current Emissions Test Data

According to Clause 7 of IEC 61000-3-2, the rated power of the EUT is less than 75W, belong to 'equipment with a rated power of 75W or less', therefore 'limits are not specified in this edition of the standards'. It is deemed to fully fit the requirements of the standards.

Result: The EUT is compliance with the requirements of this section.





## 6. Voltage Fluctuation Flicker

### 6.1 Test Procedure

Test is conducted under the description of IEC 61000-3-3.

### 6.2 Test Standards

IEC 61000-3-3, Limit: Clause 5.

### 6.3 Environmental Conditions

Temperature:	23.5 °C
Relative Humidity:	53 %
ATM Pressure:	998 mbar

### 6.4 Basic Test Setup Block Diagram

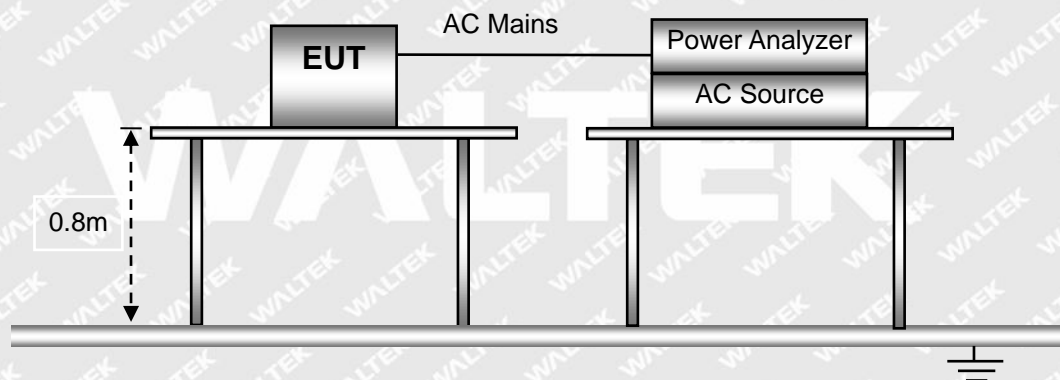

### 6.5 Voltage Fluctuation and Flicker Test Data



Test mode:	TM1
------------	-----

**Flicker Test Summary per IEC61000-3-3:2013+AMD2:2021 (Run time)**

Comment: TM1

Customer: Customer information

Test Result: Pass

Status: Test Completed

Pst and limit line

European Limits

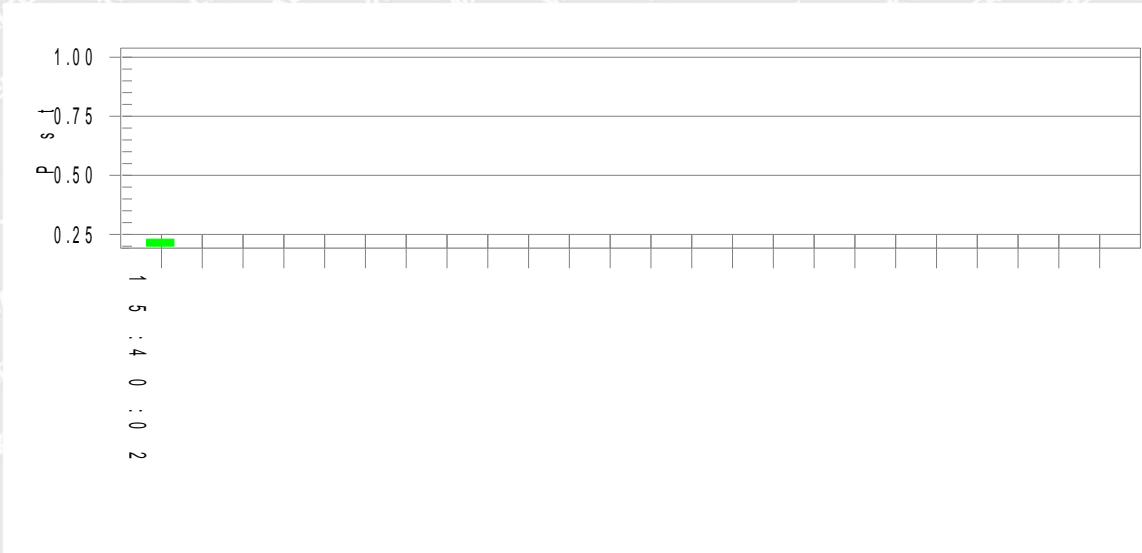

Plt and limit line

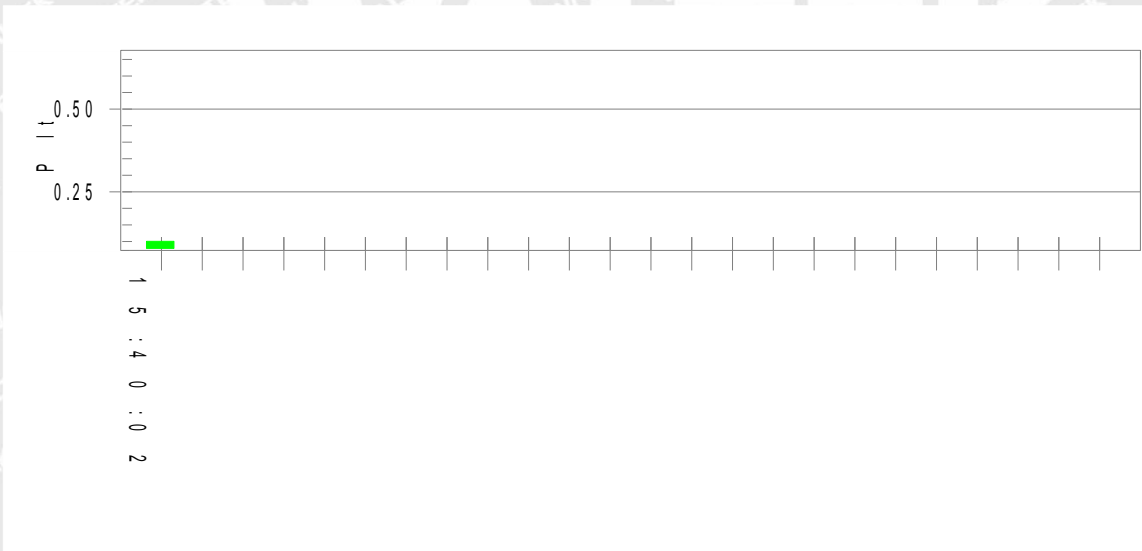

**Parameter values recorded during the test:**

Vrms at the end of test (Volt): 229.84

Highest dt (%):

Test limit (%):

T-max (mS): 0

Test limit (mS): 500.0 Pass

Highest dc (%): 0.00

Test limit (%): 3.30 Pass

Highest dmax (%): 0.00

Test limit (%): 4.00 Pass

Highest Pst (10 min. period): 0.230

Test limit: 1.000 Pass

Highest Plt (2 hr. period): 0.101

Test limit: 0.650 Pass

## 7. Electrostatic Discharges (ESD)

### 7.1 Test Procedure

Test is conducted under the description of IEC 61000-4-2.

### 7.2 Test Performance

Performance Criterion: B

### 7.3 Environmental Conditions

Temperature:	23.5 °C
Relative Humidity:	53 %
ATM Pressure:	998 mbar

### 7.4 Basic Test Setup Block Diagram

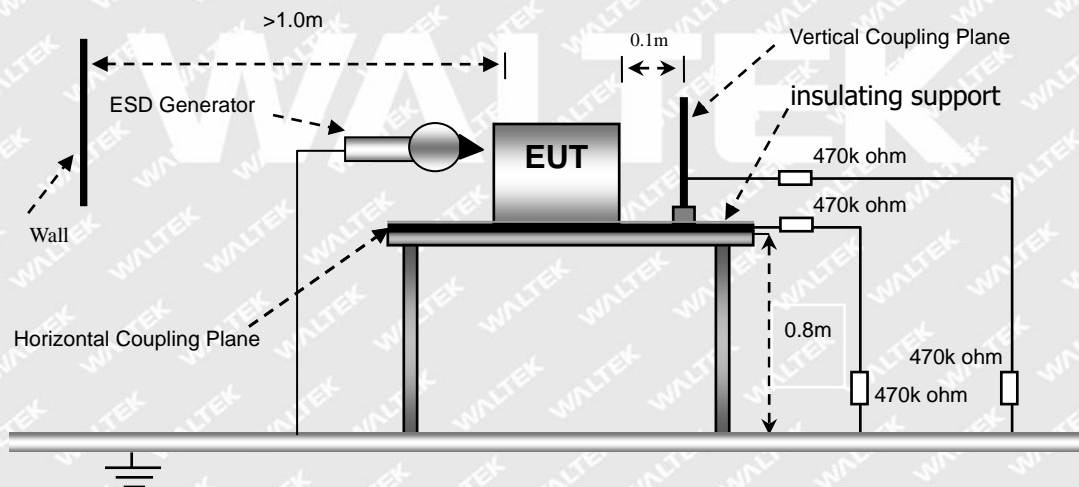



## 7.5 Electrostatic Discharge Immunity Test Data

Table 1: Electrostatic Discharge Immunity (Air Discharge)

IEC 61000-4-2 Test Points	Test Voltage (kV)									
	-2	+2	-4	+4	-8	+8	-15	+15	-18	+18
Shell edge crack	A	A	A	A	A	A	A	A	/	/
Pilot lamp	A	A	A	A	A	A	A	A	/	/

Table 2: Electrostatic Discharge Immunity (Direct Contact)

IEC 61000-4-2 Test Points	Test Voltage (kV)									
	-2	+2	-4	+4	-8	+8	-15	+15	-18	+18
/	/	/	/	/	/	/	/	/	/	/

Table 3: Electrostatic Discharge Immunity (Indirect Contact HCP & VCP)

IEC 61000-4-2 Test Points	Test Voltage (kV)									
	-2	+2	-4	+4	-8	+8	-15	+15	-18	+18
HCP (6 Sides)	A	A	A	A	A	A	/	/	/	/
VCP (4 Sides)	A	A	A	A	A	A	/	/	/	/

Test Result: Pass

## 8. Continuous RF Electromagnetic Field Disturbances (RS)

### 8.1 Test Procedure

Test is conducted under the description of IEC 61000-4-3.

### 8.2 Test Performance

Performance Criterion: A

### 8.3 Environmental Conditions

Temperature:	23.0 °C
Relative Humidity:	54 %
ATM Pressure:	998 mbar

### 8.4 Basic Test Setup Block Diagram

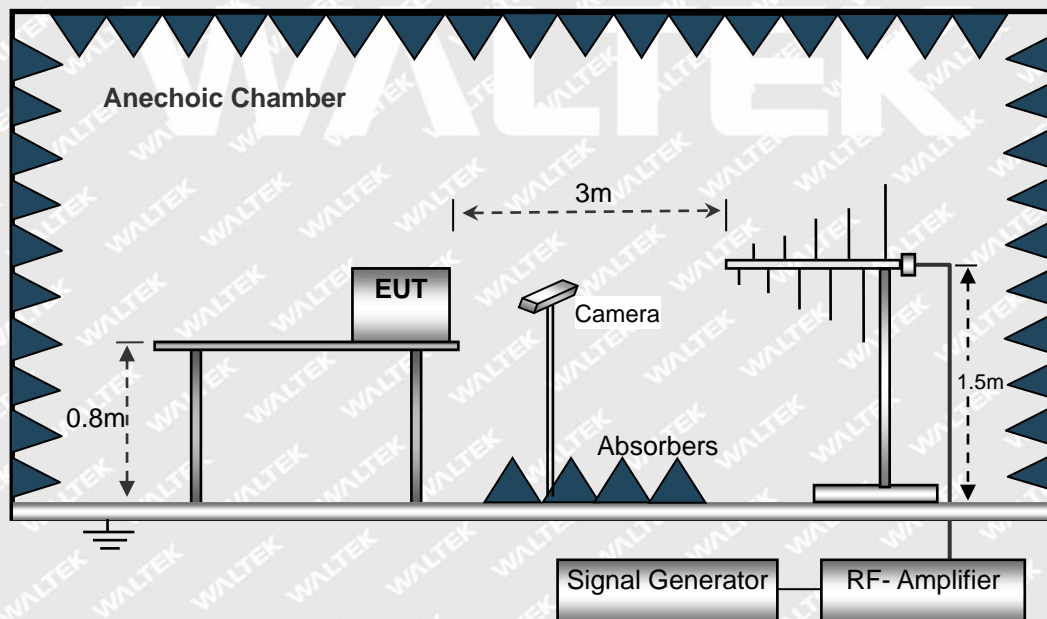



### 8.5 Continuous Radiated Disturbances Test Data

Frequency step: 1% of fundamental

Dwell time: 1 second

Modulation: AM by 1kHz sine wave with 80% modulation depth

Frequency Range(MHz)	Field (V/m)	Front		Rear		Left Side		Right Side	
		VERT	HORI	VERT	HORI	VERT	HORI	VERT	HORI
80-2700	10	A	A	A	A	A	A	A	A

Test Result: Pass

# WALTEK



## 9. Electrical Fast Transients (EFT)

### 9.1 Test Procedure

Test is conducted under the description of IEC 61000-4-4.

### 9.2 Test Performance

Performance Criterion: B

### 9.3 Environmental Conditions

Temperature:	23.5 °C
Relative Humidity:	53 %
ATM Pressure:	998 mbar

### 9.4 Basic Test Setup Block Diagram

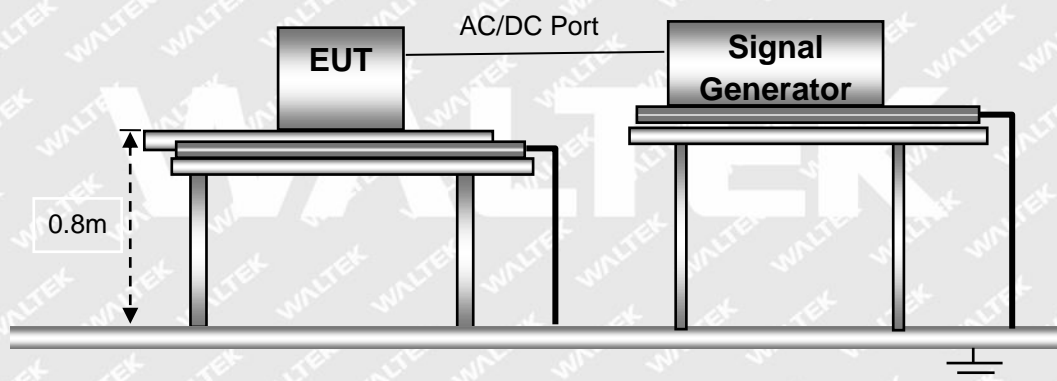



## 9.5 Electrical Fast Transients Test Data

Repetition frequency 100 kHz

IEC 61000-4-4 Test Points		Test Voltage (kV)							
		+0.5	-0.5	+1.0	-1.0	+2.0	-2.0	+4.0	-4.0
Power Supply Power Port of EUT	L	/	/	/	/	A	A	/	/
	N	/	/	/	/	A	A	/	/
	PE	/	/	/	/	A	A	/	/
	L+N	/	/	/	/	A	A	/	/
	L+PE	/	/	/	/	A	A	/	/
	N+PE	/	/	/	/	A	A	/	/
	L+N+PE	/	/	/	/	A	A	/	/
Signal ports	RJ45	/	/	/	/	/	/	/	/

Test Result: Pass

# WALTEK





## 10. Surges

---

### 10.1 Test Procedure

Test is conducted under the description of IEC 61000-4-5.

### 10.2 Test Performance

Performance Criterion: B

### 10.3 Environmental Conditions

Temperature:	23.5 °C
Relative Humidity:	53 %
ATM Pressure:	998 mbar

### 10.4 Basic Test Setup Block Diagram

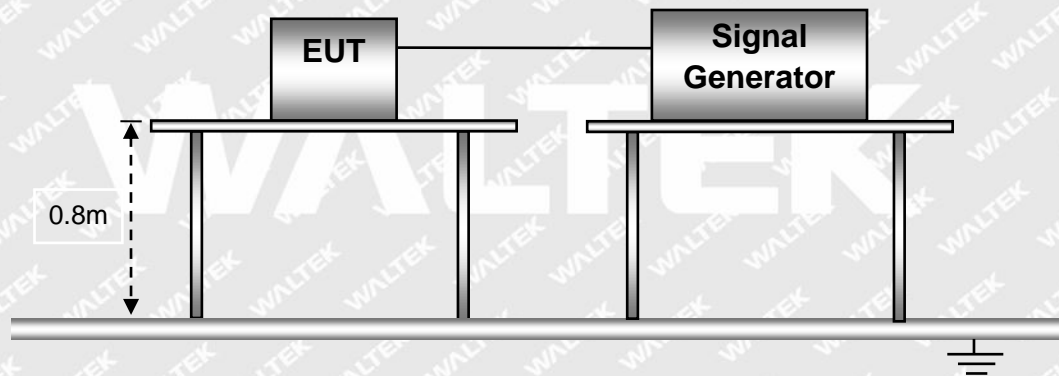



### 10.5 Surge Test Data

Test Voltage (kV)	Poll	Path	Pass	Fail
0.5kV	±	L-N, L-PE, N-PE	A	/
1kV	±	L-N, L-PE, N-PE	A	/
2kV	±	L-PE, N-PE	A	/
4kV	±	L-N, L-PE, N-PE	/	/

Test Result: Pass

# WALTEK



## 11. Continuous Induced RF Disturbances (C/S)

### 11.1 Test Procedure

Test is conducted under the description of IEC 61000-4-6.

### 11.2 Test Performance

Performance Criterion: A

### 11.3 Environmental Conditions

Temperature:	23.5 °C
Relative Humidity:	53 %
ATM Pressure:	998 mbar

### 11.4 Basic Test Setup Block Diagram

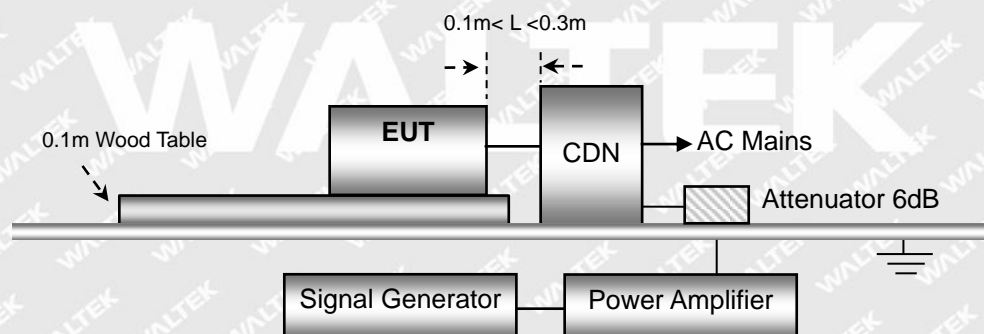



## 11.5 Continuous Conducted Disturbances Test Data

Sweep frequency range: 0.15 MHz to 80 MHz

Frequency step: 1% of fundamental

Dwell time: 1 second

AC Port

Frequency MHz	Injected Position	Voltage level (e.m.f.)	Observations (Performance Criterion)	Result
0.15-80	AC Mains	1V	/	Pass
0.15-80	AC Mains	3V	A	Pass
0.15-80	AC Mains	10V	/	Pass

Test Result: Pass

# WALTEK



## 12. Power-Frequency Magnetic Fields (PFMF)

### 12.1 Test Procedure

Test is conducted under the description of IEC 61000-4-8.

### 12.2 Test Performance

Performance Criterion: A

### 12.3 Environmental Conditions

Temperature:	23.5 °C
Relative Humidity:	53 %
ATM Pressure:	998 mbar

### 12.4 Basic Test Setup Block Diagram

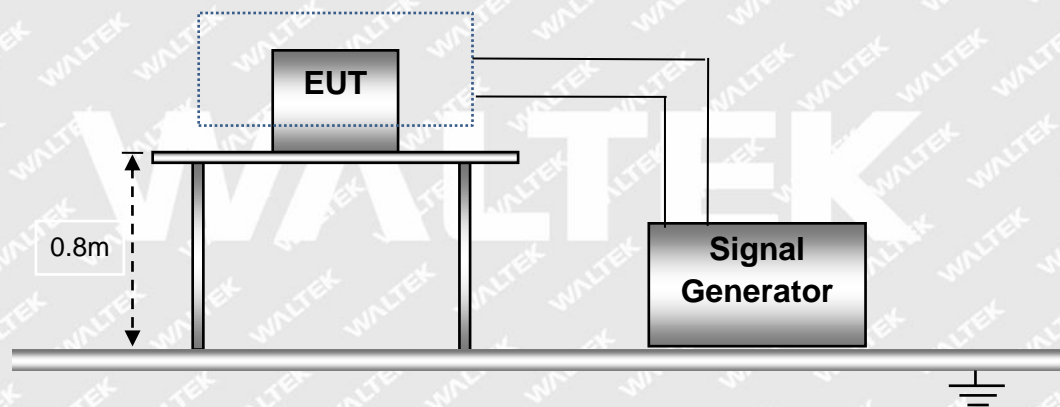

### 12.5 Power-Frequency Magnetic Field Test Data

Level	Magnetic Field Strength (r.m.s) A/m	Frequency Hz	Induction Coil Position	Pass	Fail
1	1	50/60	X, Y, Z	/	/
2	3	50/60	X, Y, Z	/	/
3	10	50/60	X, Y, Z	/	/
4	30	50/60	X, Y, Z	A	/

Test Result: Pass



## 13. Voltage Dips and Interruptions

### 13.1 Test Procedure

Test is conducted under the description of IEC 61000-4-11.

### 13.2 Test Performance

Performance Criterion: B/C

### 13.3 Environmental Conditions

Temperature:	23.5 °C
Relative Humidity:	53 %
ATM Pressure:	998 mbar

### 13.4 Basic Test Setup Block Diagram

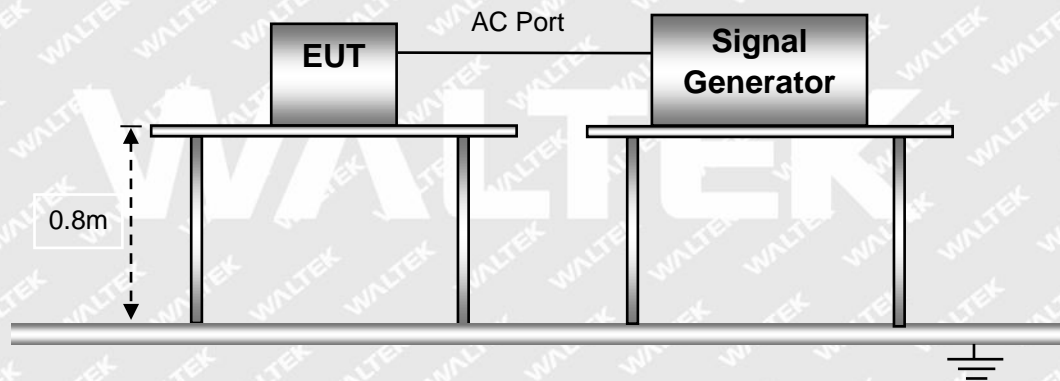

### 13.5 Voltage Dips And Interruptions Test Data

U: Voltage dips in %  $U_T$  ( $U_T$  is rated voltage for the EUT)

T: Test duration



Level	U	T	Phase Angle	N	Pass	Fail
1	100%	10ms	0°/45°/90°/135°/180°,225°/270°/315°	3	A	/
2	100%	20ms	0°/45°/90°/135°/180°,225°/270°/315°	3	A	/
3	30%	500/600ms	0°/45°/90°/135°/180°,225°/270°/315°	3	B	/
4	100%	5000/6000ms	0°/45°/90°/135°/180°,225°/270°/315°	3	B	/

Test Result: Pass



## EXHIBIT 1 - PRODUCT LABELING

### Proposed CE Label Format

**ITE/Medical Power Supply**  
Model: GT(M or -)21097-X-Y.Y series  
Brand:     
Importer Name: XXX  
Importer Address: XXX  
1: GlobTek, Inc.2: GlobTek (Suzhou) Co., Ltd  
1: 186 Veterans Dr. Northvale, NJ 07647 USA  
2: Building 4, No. 76, Jin Ling East Rd., Suzhou Industrial Park, Suzhou, JiangSu 215021, China

**Specifications:** Text is Black in color and is justified. Labels are printed in indelible ink on permanent adhesive backing or silk-screened onto the EUT or shall be affixed at a conspicuous location on the EUT. The 'CE' marking must be affixed to the EUT or to its data plate. Where this is not possible or not warranted on account of the nature of the apparatus, it must be affixed to the packaging, if any, and to the accompanying documents. The 'CE' marking must have a height of at least 5 mm. If the 'CE' marking is reduced or enlarged the proportions given in the above graduated drawing must be respected. The Importer name, address and Manufacturer name and address should indicate on marking label or packaging or in a document accompanying.

### Proposed Label Location on EUT

CE Label Location





## EXHIBIT 2 - EUT PHOTOGRAPHS

---

EUT View 1

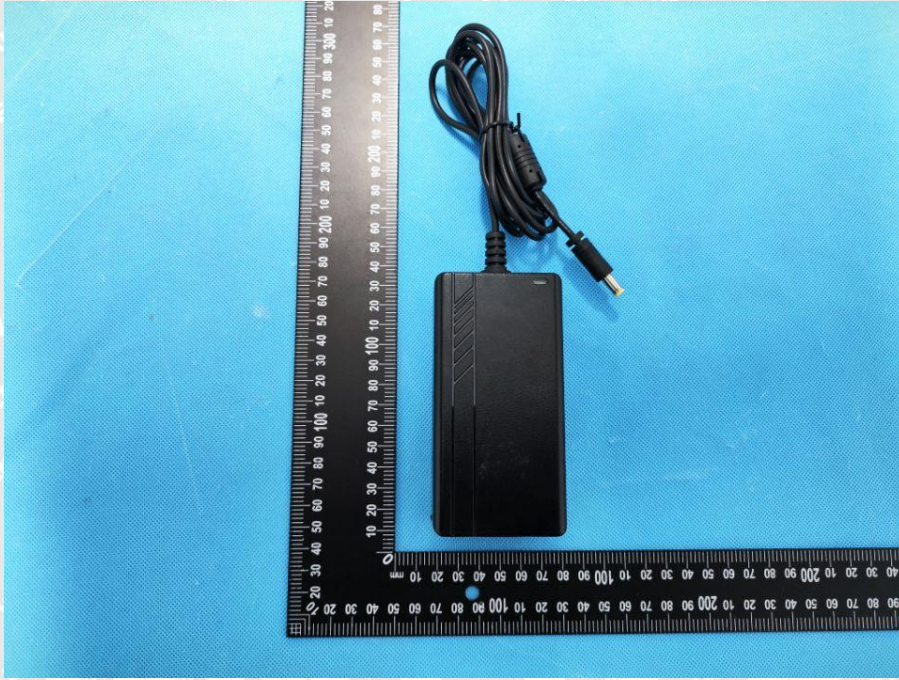

EUT View 2







EUT View 3



EUT View 4





**EUT View 5**



**WALTEK**



**EUT Housing and Board View 1**



**Solder Board-Component View 2**





**Solder Board-Component View 3**

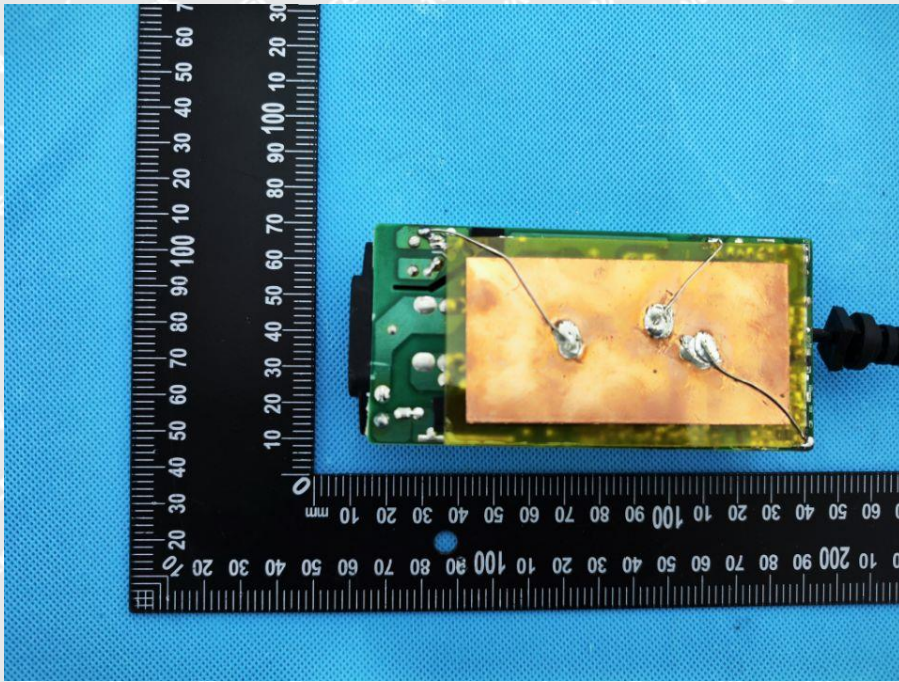

**WALTEK**



## EXHIBIT 3 - TEST SETUP PHOTOGRAPHS

---

**Conduction Emission Test View**



**Radiation Emission Test View**

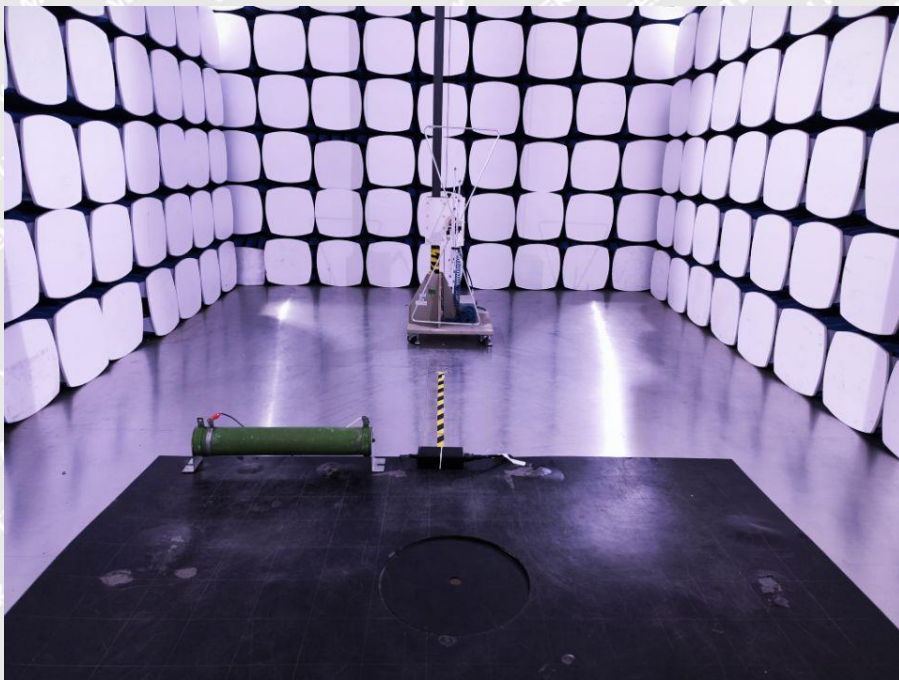



**Harmonic/Flicker Test View**

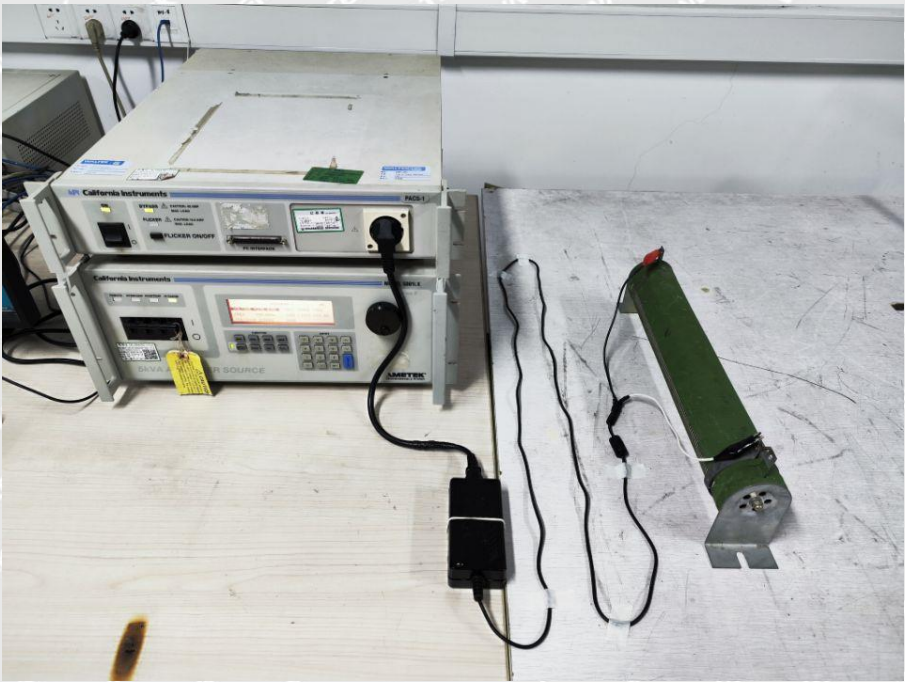

**IEC 61000-4-2 Test View**





IEC 61000-4-3 Test View

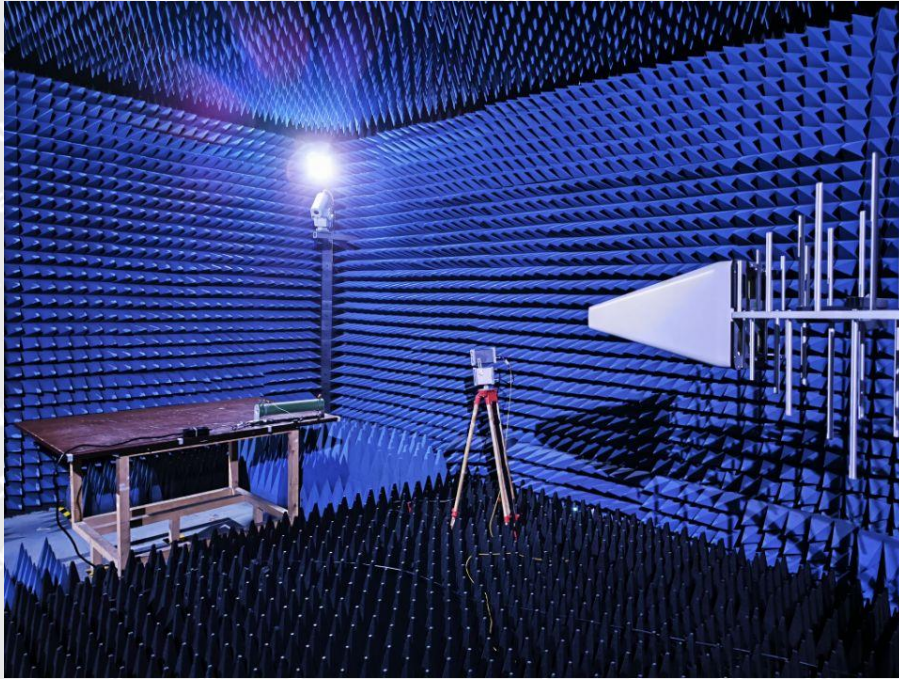

IEC 61000-4-4/5/11 Test View





**IEC 61000-4-6 Test View**



**IEC 61000-4-8 Test View**

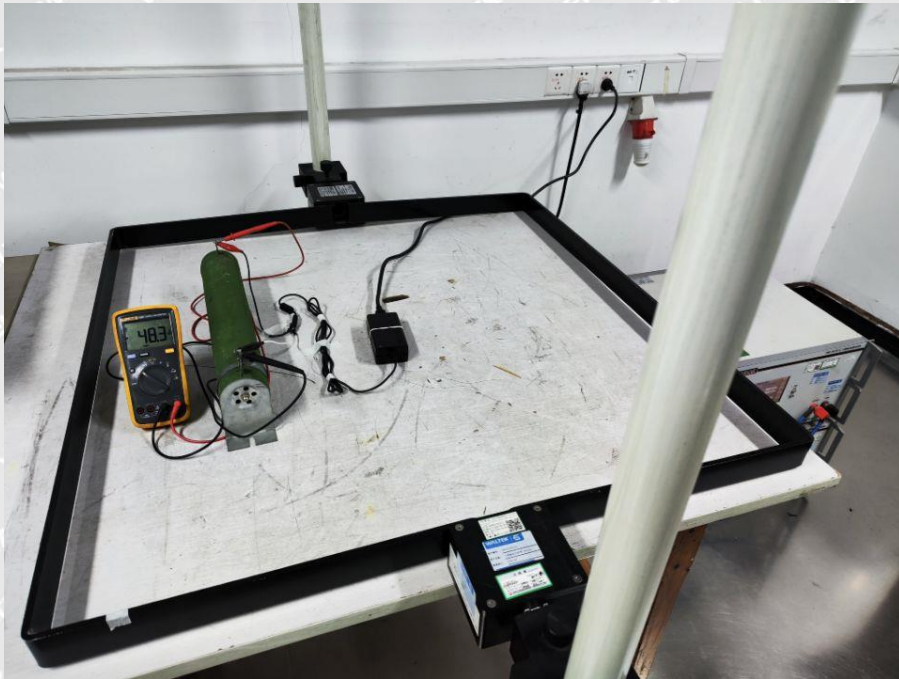

\*\*\*\*\* END OF REPORT \*\*\*\*\*