



Test Report issued under the responsibility of:



**TEST REPORT  
IEC 62368-1**

**Audio/video, information and communication technology equipment  
Part 1: Safety requirements**

**Report Number** .....: 50352378 001  
**Date of issue** .....: 2020-04-10  
**Total number of pages** .....: 65

**Applicant's name** .....: GlobTek, Inc.  
**Address** .....: 186 Veterans Dr. Northvale, NJ 07647, USA

**Test specification:**  
**Standard**.....: IEC 62368-1:2014 (Second Edition)  
**Test procedure**.....: CB Scheme  
**Non-standard test method**.....: N/A

**Test Report Form No.**.....: IEC62368\_1B  
**Test Report Form(s) Originator**.....: UL (US)  
**Master TRF** .....: 2014-03

**Copyright © 2014 Worldwide System for Conformity Testing and Certification of Electrotechnical Equipment and Components (IECEE), Geneva, Switzerland. All rights reserved.**

This publication may be reproduced in whole or in part for non-commercial purposes as long as the IECEE is acknowledged as copyright owner and source of the material. IECEE takes no responsibility for and will not assume liability for damages resulting from the reader's interpretation of the reproduced material due to its placement and context.



If this Test Report Form is used by non-IECEE members, the IECEE/IEC logo and the reference to the CB Scheme procedure shall be removed.

**This report is not valid as a CB Test Report unless signed by an approved CB Testing Laboratory and appended to a CB Test Certificate issued by an NCB in accordance with IECEE 02.**

**General disclaimer:**

The test results presented in this report relate only to the object tested.  
This report shall not be reproduced, except in full, without the written approval of the Issuing CB Testing Laboratory. The authenticity of this Test Report and its contents can be verified by contacting the NCB, responsible for this Test Report.

Test Item description .....	ICT/ITE POWER SUPPLY
Trade Mark .....	 <b>GlobTek® ,Inc.</b>
Manufacturer .....	Same as applicant
Model/Type reference .....	GT-86122-WWVV-W2Z (WW, VV and Z are variables, for details see model list on page 6)
Ratings .....	Input: see model list on page 6 Output: see model list on page 6

Testing procedure and testing location:		
<input checked="" type="checkbox"/>	<b>CB Testing Laboratory:</b>	TÜV Rheinland Shanghai Co., Ltd.
<b>Testing location/ address .....</b> :		No.177, 178, Lane 777, West Guangzhong Road, Jing'an District, Shanghai, China
<input type="checkbox"/>	<b>Associated CB Testing Laboratory:</b>	
<b>Testing location/ address.....</b> :		
<b>Tested by (name + signature).....:</b>		Johnson Ma / Technical Expert
<b>Approved by (name + signature) .....</b> :		Sunny Sun / Reviewer
		
		
<input type="checkbox"/>	<b>Testing procedure: TMP/CTF Stage 1</b>	
<b>Testing location/ address.....</b> :		
<b>Tested by (name + signature).....:</b>		
<b>Approved by (name + signature) .....</b> :		
<input type="checkbox"/>	<b>Testing procedure: WMT/CTF Stage 2</b>	
<b>Testing location/ address.....</b> :		
<b>Tested by (name + signature).....:</b>		
<b>Witnessed by (name + signature) .....</b> :		
<b>Approved by (name + signature) .....</b> :		
<input type="checkbox"/>	<b>Testing procedure: SMT/CTF Stage 3 or 4</b>	
<b>Testing location/ address.....</b> :		
<b>Tested by (name + signature).....:</b>		
<b>Approved by (name + signature) .....</b> :		
<b>Supervised by (name + signature) .....</b> :		

<b>List of Attachments (including a total number of pages in each attachment):</b> <ul style="list-style-type: none"> <li>- Attachment 1: National Differences (34 pages)</li> <li>- Attachment 2: Plug portion test (5 pages)</li> <li>- Attachment 3: Photo documentation (17 pages)</li> </ul>	
<b>Summary of testing:</b>	
<b>Tests performed (name of test and test clause):</b> This CB test report is based on the previous CB test report No. 50285931 001 with certificate No. JPTUV-101355 with following changes: <ol style="list-style-type: none"> <li>1. Applicant and Manufacturer</li> <li>2. Model/Type reference</li> </ol> No further testing was deemed necessary for this test report.	<b>Testing location:</b>  <b>TÜV Rheinland Shanghai Co., Ltd.</b> No.177, 178, Lane 777, West Guangzhong Road, Jing'an District, Shanghai, China
<b>Summary of compliance with National Differences:</b> List of countries addressed: (According to IEC 62368-1:2014 (Second Edition)) EU Group Differences, EU Special National Conditions AU, DE, DK, FI, GB, IE, JP, NO, NZ, SE, US Explanation of used codes: AU=Australia, DE=Germany, DK=Denmark, FI=Finland, GB= United Kingdom, IE=Ireland, JP=Japan, NO=Norway, NZ=New Zealand, SE=Sweden, US=United States of America.	
<input checked="" type="checkbox"/> The product fulfils the requirements of EN 62368-1:2014+A11:2017.	
<b>Copy of marking plate(s):</b> The artwork below may be only a draft. The use of certification marks on a product must be authorized by the respective NCBs that own these marks.	
	
<b>Notes:</b> <ol style="list-style-type: none"> <li>1. Since similar label used, only labels for models above listed to represent other similar ones.</li> <li>2. The CE marking symbol (if any) should be at least 5.0mm in height.</li> <li>3. The manufacturer's address and importer's name and address should be provided on label or package or a document accompanying the equipment before the product is placed on the EU market.</li> </ol>	

<b>TEST ITEM PARTICULARS:</b>	
Classification of use by .....	<input checked="" type="checkbox"/> Ordinary person <input type="checkbox"/> Instructed person <input type="checkbox"/> Skilled person <input checked="" type="checkbox"/> Children likely to be present
Supply Connection.....	<input checked="" type="checkbox"/> AC Mains <input type="checkbox"/> DC Mains <input type="checkbox"/> External Circuit - not Mains connected - <input type="checkbox"/> ES1 <input type="checkbox"/> ES2 <input type="checkbox"/> ES3
Supply % Tolerance .....	<input checked="" type="checkbox"/> +10%/-10% <input type="checkbox"/> +20%/-15% <input type="checkbox"/> + ___ %/ - ___ % <input type="checkbox"/> None
Supply Connection – Type .....	<input checked="" type="checkbox"/> pluggable equipment type A - <input type="checkbox"/> non-detachable supply cord <input type="checkbox"/> appliance coupler <input checked="" type="checkbox"/> direct plug-in <input type="checkbox"/> mating connector <input type="checkbox"/> pluggable equipment type B - <input type="checkbox"/> non-detachable supply cord <input type="checkbox"/> appliance coupler <input type="checkbox"/> permanent connection <input type="checkbox"/> mating connector <input type="checkbox"/> other: _____
Considered current rating of protective device as part of building or equipment installation.....	16 A (20A for US and CA, 13A for UK) Installation location: <input checked="" type="checkbox"/> building; <input type="checkbox"/> equipment
Equipment mobility .....	<input type="checkbox"/> movable <input type="checkbox"/> hand-held <input type="checkbox"/> transportable <input type="checkbox"/> stationary <input type="checkbox"/> for building-in <input checked="" type="checkbox"/> direct plug-in <input type="checkbox"/> rack-mounting <input type="checkbox"/> wall-mounted
Over voltage category (OVC) .....	<input type="checkbox"/> OVC I <input checked="" type="checkbox"/> OVC II <input type="checkbox"/> OVC III <input type="checkbox"/> OVC IV <input type="checkbox"/> other: _____
Class of equipment .....	<input type="checkbox"/> Class I <input checked="" type="checkbox"/> Class II <input type="checkbox"/> Class III
Access location .....	<input type="checkbox"/> restricted access location <input checked="" type="checkbox"/> N/A
Pollution degree (PD) .....	<input type="checkbox"/> PD 1 <input checked="" type="checkbox"/> PD 2 <input type="checkbox"/> PD 3
Manufacturer's specified maximum operating ambient.....	45°C
IP protection class .....	<input checked="" type="checkbox"/> IPX0 <input type="checkbox"/> IP ____
Power Systems .....	<input checked="" type="checkbox"/> TN <input type="checkbox"/> TT <input type="checkbox"/> IT - 230 V <sub>L-L</sub>
Altitude during operation (m) .....	<input type="checkbox"/> 2000 m or less <input checked="" type="checkbox"/> Up to 5000m
Altitude of test laboratory (m) .....	<input checked="" type="checkbox"/> 2000 m or less <input type="checkbox"/> _____ m
Mass of equipment (kg) .....	<input checked="" type="checkbox"/> Approx. 0.054kg

<b>POSSIBLE TEST CASE VERDICTS:</b>	
- test case does not apply to the test object .....	N/A

- test object does meet the requirement..... :	P (Pass)
- test object does not meet the requirement..... :	F (Fail)
<b>TESTING:</b>	
Date of receipt of test item..... :	2019-09-20 for report no. 50285931 001 2020-03-06 for this report
Date (s) of performance of tests..... :	2019-09-20 to 2019-10-10 for report no. 50285931 001 2020-03-16 for this report
<b>GENERAL REMARKS:</b>	
"(See Enclosure #)" refers to additional information appended to the report. "(See appended table)" refers to a table appended to the report. Throughout this report a <input type="checkbox"/> comma / <input checked="" type="checkbox"/> point is used as the decimal separator.	
<b>Manufacturer's Declaration per sub-clause 4.2.5 of IEC 62368-1:</b>	
The application for obtaining a CB Test Certificate includes more than one factory location and a declaration from the Manufacturer stating that the sample(s) submitted for evaluation is (are) representative of the products from each factory has been provided..... :	<input checked="" type="checkbox"/> <b>Yes</b> <input type="checkbox"/> <b>Not applicable</b>
<b>When differences exist; they shall be identified in the General product information section.</b>	
<b>Name and address of factory (ies)..... :</b>	<b>1. GlobTek, Inc.</b> 186 Veterans Dr. Northvale, NJ 07647 USA  <b>2. GlobTek (Suzhou) Co., Ltd.</b> Building 4, No. 76, Jinling East Road, Suzhou Industrial Park, 215021 Jiangsu, P.R. China
<b>GENERAL PRODUCT INFORMATION:</b>	
1. The apparatus are class II switching adapter (direct plug-in type, detachable) used for DC supply of Audio/video, information and communication technology equipment, the output cord is non-detachable. 2. The power adapter's top enclosure is secured to bottom enclosure by ultrasonic welding. 3. Pre-production samples without serial numbers. 4. Specified maximum ambient temperature is 45°C. 5. The plug pins of all plug types are moulded into the enclosure directly. It is impossible to remain in the mains socket-outlet after removal of the adapter, details see photo document. 6. All models were evaluated for a maximum operating altitude of 5000m. Therefore the requirements of IEC 62368-1 for clearances were considered and the required clearance was multiplied with an altitude correction factor of 1.48.	
<b>Model difference:</b>	
1. R1, R2, R3, R5, R6, R7, R8, R9, R10, R11, R12, C1, C2, C3, C5, C6, C7, U2, D3, T1: The parameters of these components depend on output current and voltage. 2. All models are identical except for model designation, plug portion, and output current. 3. Configuration:	

Item	LF1	LF2	CY1	PCB A (use D3)	PCB B (use IC U2)
1	Difference	With	Without	For output 12V	For output 5-5.2V
2	common	With	Without	For output 12V	For output 5-5.2V
3	Difference	Without	with	For output 12V	For output 5-5.2V
4	common	Without	with	For output 12V	For output 5-5.2V

**Model list:**

**GT-86122-WVVV-WZZ** ("WW", "VV", "Z" are variables)

Model Name	INPUT	OUTPUT		
		V dc	Max. A	Max. W
GT-86122-WVVV-WZZ	100-240Vac, 50/60Hz 0.5A	12.0	1.0	12
		5.0-5.2	2.1	11

**Note:**

Variable:	Range of variable:	Content:
WW	Max. 12	Means the standard output wattage, WW is 2 digit number with a maximum value of "12"
VV	can be "05-05.2", "12" or "5.0-5.2", "12.0"	the standard rated output voltage designation, with interval of 0.1V
Z	can be E, U, blank, C, I, A, K, AR, BR, SA or AF	designates type of plug and can be E for European plug, U for British plug, blank for North American / Japan plug/Taiwan plug, C for Chinese plug, I for India plug, A for Australia plug, K for Korea plug, AR for Argentina plug, BR for Brazilian plug, SA or AF for South African plug

<b>ENERGY SOURCE IDENTIFICATION AND CLASSIFICATION TABLE:</b>	
(Note 1: Identify the following six (6) energy source forms based on the origin of the energy.) (Note 2: The identified classification e.g., ES2, TS1, should be with respect to its ability to cause pain or injury on the body or its ability to ignite a combustible material. Any energy source can be declared Class 3 as a worse case classification e.g. PS3, ES3.)	
<b>Electrically-caused injury (Clause 5):</b> (Note: Identify type of source, list sub-assembly or circuit designation and corresponding energy source classification) Example: +5 V dc input <span style="float: right;">ES1</span>	
<b>Source of electrical energy</b>	<b>Corresponding classification (ES)</b>
Primary circuit	ES3
Output circuit	ES1
<b>Electrically-caused fire (Clause 6):</b> (Note: List sub-assembly or circuit designation and corresponding energy source classification) Example: Battery pack (maximum 85 watts): <span style="float: right;">PS2</span>	
<b>Source of power or PIS</b>	<b>Corresponding classification (PS)</b>
Primary circuit	PS3
Output terminal	PS1
<b>Injury caused by hazardous substances (Clause 7)</b> (Note: Specify hazardous chemicals, whether produces ozone or other chemical construction not addressed as part of the component evaluation.) Example: Liquid in filled component <span style="float: right;">Glycol</span>	
<b>Source of hazardous substances</b>	<b>Corresponding chemical</b>
N/A	None
<b>Mechanically-caused injury (Clause 8)</b> (Note: List moving part(s), fan, special installations, etc. & corresponding MS classification based on Table 35.) Example: Wall mount unit <span style="float: right;">MS2</span>	
<b>Source of kinetic/mechanical energy</b>	<b>Corresponding classification (MS)</b>
Edges and corners of enclosure	MS1
Mass of the unit	MS1
<b>Thermal burn injury (Clause 9)</b> (Note: Identify the surface or support, and corresponding energy source classification based on type of part, location, operating temperature and contact time in Table 38.) Example: Hand-held scanner – thermoplastic enclosure <span style="float: right;">TS1</span>	
<b>Source of thermal energy</b>	<b>Corresponding classification (TS)</b>
External surfaces	TS1 for accessible part
<b>Radiation (Clause 10)</b> (Note: List the types of radiation present in the product and the corresponding energy source classification.) Example: DVD – Class 1 Laser Product <span style="float: right;">RS1</span>	
<b>Type of radiation</b>	<b>Corresponding classification (RS)</b>
N/A	None

**ENERGY SOURCE DIAGRAM**

Indicate which energy sources are included in the energy source diagram. Insert diagram below

**See above table**
**ES3 (on the left side of transformer T1), PS3 (on the left side of transformer T1), enclosure surface is TS1**
**ES1 (on the right side of transformer T1), output is PS1 energy source, all areas contains PIS sources**

ES     
  PS     
  MS     
  TS     
  RS



<b>OVERVIEW OF EMPLOYED SAFEGUARDS</b>				
<b>Clause</b>	<b>Possible Hazard</b>			
5.1	Electrically-caused injury			
Body Part (e.g. Ordinary)	Energy Source (ES3: Primary Filter circuit)	Safeguards		
		Basic	Supplementary	Reinforced (Enclosure)
Ordinary	ES3: primary circuit	N/A	N/A	Enclosure, See 5.4.2, 5.4.3, 5.5.3, 5.5.4
Ordinary	ES1: Output connector	N/A	N/A	N/A
6.1	Electrically-caused fire			
Material part (e.g. mouse enclosure)	Energy Source	Safeguards		
		Basic	Supplementary	Reinforced
Combustible materials within equipment	PS3: >100 Watt circuit (Primary circuit)	Equipment safeguard	Equipment safeguards	N/A
Output connector	PS1: ≤15 Watt circuit	N/A	N/A	N/A
7.1	Injury caused by hazardous substances			
Body Part (e.g., skilled)	Energy Source (hazardous material)	Safeguards		
		Basic	Supplementary	Reinforced
N/A	N/A	N/A	N/A	N/A
8.1	Mechanically-caused injury			
Body Part (e.g. Ordinary)	Energy Source (MS3:High Pressure Lamp)	Safeguards		
		Basic	Supplementary	Reinforced (Enclosure)
Ordinary	MS1: Edges and corners	N/A	N/A	N/A
Mass of the unit	MS: <7kg	N/A	N/A	N/A
9.1	Thermal Burn			
Body Part (e.g., Ordinary)	Energy Source (TS2)	Safeguards		
		Basic	Supplementary	Reinforced
Ordinary	TS1: Plastic enclosure	N/A	N/A	N/A
10.1	Radiation			
Body Part (e.g., Ordinary)	Energy Source (Output from audio port)	Safeguards		
		Basic	Supplementary	Reinforced
N/A	N/A	N/A	N/A	N/A
Supplementary Information:				
(1) See attached energy source diagram for additional details.				
(2) "N" – Normal Condition; "A" – Abnormal Condition; "S" Single Fault				

IEC 62368-1			
Clause	Requirement + Test	Result - Remark	Verdict
<b>4</b>	<b>GENERAL REQUIREMENTS</b>		P
4.1.1	Acceptance of materials, components and subassemblies	See appended table 4.1.2	P
4.1.2	Use of components	Components which are certified to IEC and/or national standards are used correctly within their ratings. Components not covered by IEC standards are tested under the conditions present in the equipment. See also Annex G.	P
4.1.3	Equipment design and construction	Evaluation of safeguards regarding preventing access to ES3 parts, limiting the source supplying outputs to fulfill ES1, and protection in regard to risk of ignition, mechanical-caused injury and thermal burn considered.	P
4.1.15	Markings and instructions .....	(See Annex F)	P
4.4.4	Safeguard robustness	See below.	P
4.4.4.2	Steady force tests .....	(See Annex T.2, T.4 and T.5)	P
4.4.4.3	Drop tests .....	(See Annex T.7)	P
4.4.4.4	Impact tests.....	Direct plug in equipment	N/A
4.4.4.5	Internal accessible safeguard enclosure and barrier tests.....	The external enclosure cannot be opened without damaging the product.	N/A
4.4.4.6	Glass Impact tests.....	No such glass used.	N/A
4.4.4.7	Thermoplastic material tests .....	After 7 hours and cooling down to room temperature, no shrinkage, distortion or loosening any enclosure part was noticeable on the adapter. Test was performed for all sources of enclosure material, detail see Annex T.8.	P
4.4.4.8	Air comprising a safeguard .....	(See Annex T)	P
4.4.4.9	Accessibility and safeguard effectiveness	After tests of 4.4.4.2, 4.4.4.3, 4.4.4.7, no safeguard damaged.	P
4.5	Explosion	No explosion occurs during normal/abnormal operation and single fault conditions	P
4.6	Fixing of conductors		P
4.6.1	Fix conductors not to defeat a safeguard	The conductors will be connected by wire terminals.	P

<b>IEC 62368-1</b>			
Clause	Requirement + Test	Result - Remark	Verdict
4.6.2	10 N force test applied to .....	See appended table 5.4.2.2, 5.4.2.4 and 5.4.3	P
4.7	Equipment for direct insertion into mains socket - outlets	Direct plug-in equipment.	P
4.7.2	Mains plug part complies with the relevant standard.....	The dimension and construction of European plug portion part is in accordance with: EN 50075:1990. The plugs for other countries shall be evaluated when submitted for national approval.	P
4.7.3	Torque (Nm) .....	Max. 0.022Nm for all orientation of both vertical and horizontal enclosure with each plug.	P
4.8	Products containing coin/button cell batteries	No coin/button cell batteries used.	N/A
4.8.2	Instructional safeguard		N/A
4.8.3	Battery Compartment Construction		N/A
	Means to reduce the possibility of children removing the battery .....		—
4.8.4	Battery Compartment Mechanical Tests .....		N/A
4.8.5	Battery Accessibility		N/A
4.9	Likelihood of fire or shock due to entry of conductive object .....	No likelihood of conductive object entering into enclosure.	P

<b>5</b>	<b>ELECTRICALLY-CAUSED INJURY</b>		P
5.2.1	Electrical energy source classifications .....	(See appended table 5.2)	P
5.2.2	ES1, ES2 and ES3 limits		P
5.2.2.2	Steady-state voltage and current .....	(See appended table 5.2)	P
5.2.2.3	Capacitance limits .....		N/A
5.2.2.4	Single pulse limits.....	No such single pulses generated in the EUT or applied to it.	N/A
5.2.2.5	Limits for repetitive pulses.....	No such repetitive pulses within the EUT	N/A
5.2.2.6	Ringling signals .....	No such ringling signals within the EUT	N/A
5.2.2.7	Audio signals .....	No such audio signals	N/A
5.3	Protection against electrical energy sources	See below	P
5.3.1	General Requirements for accessible parts to ordinary, instructed and skilled persons	See only 4.3 and 5.3 to 5.5 which applies to protection between the accessible parts and hazardous parts of other circuits.	P

IEC 62368-1			
Clause	Requirement + Test	Result - Remark	Verdict
5.3.2.1	Accessibility to electrical energy sources and safeguards	Only ES1 circuit can be accessed for this product.	P
5.3.2.2	Contact requirements	No openings allowing entry of a probe. No access with test probe to any ES3 circuit or parts.	P
	a) Test with test probe from Annex V.....:		N/A
	b) Electric strength test potential (V).....:		N/A
	c) Air gap (mm) .....		N/A
5.3.2.4	Terminals for connecting stripped wire	No stripped wire used.	N/A
5.4	Insulation materials and requirements		P
5.4.1.2	Properties of insulating material	The choice and application have taken into account as specified in this Clause 5 and Annex T and natural rubber, hygroscopic materials or asbestos are not used as insulation.	P
5.4.1.3	Humidity conditioning .....	No hygroscopic material used.	P
5.4.1.4	Maximum operating temperature for insulating materials .....	(See appended table 5.4.1.4)	P
5.4.1.5	Pollution degree .....	2	—
5.4.1.5.2	Test for pollution degree 1 environment and for an insulating compound	Pollution degree 2 is applied. No insulating compound applied (however see 5.5.4).	N/A
5.4.1.5.3	Thermal cycling	See above	N/A
5.4.1.6	Insulation in transformers with varying dimensions	No such transformer.	N/A
5.4.1.7	Insulation in circuits generating starting pulses	No such starting pulses.	N/A
5.4.1.8	Determination of working voltage	(See appended table 5.4.1.8)	P
5.4.1.9	Insulating surfaces		P
5.4.1.10	Thermoplastic parts on which conductive metallic parts are directly mounted	See only 5.4.10.3 below.	P
5.4.1.10.2	Vicat softening temperature.....:		N/A
5.4.1.10.3	Ball pressure .....	See appended table 5.4.1.10.3.	P
5.4.2	Clearances	The highest value of 5.4.3.3 and 5.4.2.3 be used.	P
5.4.2.2	Determining clearance using peak working voltage	Temporary overvoltage 2000V <sub>peak</sub> assumed.	P
5.4.2.3	Determining clearance using required withstand voltage .....	(See appended table 5.4.2.2, 5.4.2.4 and 5.4.3)	P
	a) a.c. mains transient voltage .....	2500 V <sub>pk</sub> considered for Overvoltage Cat. II	—

IEC 62368-1			
Clause	Requirement + Test	Result - Remark	Verdict
	b) d.c. mains transient voltage .....	Not d.c. mains.	—
	c) external circuit transient voltage .....	No such transient	—
	d) transient voltage determined by measurement :		—
5.4.2.4	Determining the adequacy of a clearance using an electric strength test	Using procedure 2 to determine the clearance according to 5.4.2.3.	N/A
5.4.2.5	Multiplication factors for clearances and test voltages .....	1.48	P
5.4.3	Creepage distances .....	(See appended table 5.4.2.2, 5.4.2.4 and 5.4.3)	P
5.4.3.1	General		P
5.4.3.3	Material Group .....	IIIa & IIIb	—
5.4.4	Solid insulation	See below	P
5.4.4.2	Minimum distance through insulation .....	(See appended table 5.4.4.2)	P
5.4.4.3	Insulation compound forming solid insulation		N/A
5.4.4.4	Solid insulation in semiconductor devices		N/A
5.4.4.5	Cemented joints		N/A
5.4.4.6	Thin sheet material	Tape used in T1	P
5.4.4.6.1	General requirements	See below.	P
5.4.4.6.2	Separable thin sheet material	Reinforced insulation consisting of two layers of tape, each layer shall pass the electric strength test for reinforced insulation.	P
	Number of layers (pcs) .....	2	P
5.4.4.6.3	Non-separable thin sheet material	No such insulation used within the EUT.	N/A
5.4.4.6.4	Standard test procedure for non-separable thin sheet material .....		N/A
5.4.4.6.5	Mandrel test		N/A
5.4.4.7	Solid insulation in wound components	See G.5.3 and G.6.1 only.	P
5.4.4.9	Solid insulation at frequencies >30 kHz .....		P
5.4.5	Antenna terminal insulation		P
5.4.5.1	General		P

IEC 62368-1			
Clause	Requirement + Test	Result - Remark	Verdict
5.4.5.2	Voltage surge test		P
	Insulation resistance (MΩ).....:	>1000 MΩ	P
5.4.6	Insulation of internal wire as part of supplementary safeguard.....:	No such insulation of internal wire as part of supplementary safeguard.	N/A
5.4.7	Tests for semiconductor components and for cemented joints	No tests necessary –see only 5.4.4.4.	N/A
5.4.8	Humidity conditioning		P
	Relative humidity (%).....:	93%	—
	Temperature (°C) .....	45°C	—
	Duration (h) .....	120h	—
5.4.9	Electric strength test.....:	(See appended table 5.4.9)	P
5.4.9.1	Test procedure for a solid insulation type test	(See appended table 5.4.9)	P
5.4.9.2	Test procedure for routine tests	Should be considered and conducted during production at factory.	N/A
5.4.10	Protection against transient voltages between external circuit	No such external circuits	N/A
5.4.10.1	Parts and circuits separated from external circuits		N/A
5.4.10.2	Test methods		N/A
5.4.10.2.1	General		N/A
5.4.10.2.2	Impulse test .....		N/A
5.4.10.2.3	Steady-state test.....:		N/A
5.4.11	Insulation between external circuits and earthed circuitry .....	No such external circuit.	N/A
5.4.11.1	Exceptions to separation between external circuits and earth		N/A
5.4.11.2	Requirements		N/A
	Rated operating voltage $U_{op}$ (V) .....		—
	Nominal voltage $U_{peak}$ (V).....:		—
	Max increase due to variation $U_{sp}$ .....:		—
	Max increase due to ageing $\Delta U_{sa}$ .....		—
	$U_{op} = U_{peak} + \Delta U_{sp} + \Delta U_{sa}$ .....:		—
5.5	Components as safeguards		
5.5.1	General	See below.	P
5.5.2	Capacitors and RC units	Approved Y capacitor (CY1) provided. See G.11.1.	P
5.5.2.1	General requirement		P

IEC 62368-1			
Clause	Requirement + Test	Result - Remark	Verdict
5.5.2.2	Safeguards against capacitor discharge after disconnection of a connector .....		N/A
5.5.3	Transformers	(See Annex G.5.3)	P
5.5.4	Optocouplers		N/A
5.5.5	Relays	No such component provided	N/A
5.5.6	Resistors	None providing a safeguard.	N/A
5.5.7	SPD's		N/A
5.5.7.1	Use of an SPD connected to reliable earthing		N/A
5.5.7.2	Use of an SPD between mains and protective earth		N/A
5.5.8	Insulation between the mains and external circuit consisting of a coaxial cable .....	No such external circuits.	N/A
5.6	Protective conductor		N/A
5.6.2	Requirement for protective conductors	Class II apparatus with no means of earthing.	N/A
5.6.2.1	General requirements		N/A
5.6.2.2	Colour of insulation		N/A
5.6.3	Requirement for protective earthing conductors		N/A
	Protective earthing conductor size (mm <sup>2</sup> ) .....		—
5.6.4	Requirement for protective bonding conductors		N/A
5.6.4.1	Protective bonding conductors		N/A
	Protective bonding conductor size (mm <sup>2</sup> ).....		—
	Protective current rating (A) .....		— •
5.6.4.3	Current limiting and overcurrent protective devices		N/A
5.6.5	Terminals for protective conductors		N/A
5.6.5.1	Requirement		N/A
	Conductor size (mm <sup>2</sup> ), nominal thread diameter (mm).....		N/A
5.6.5.2	Corrosion		N/A
5.6.6	Resistance of the protective system		N/A
5.6.6.1	Requirements		N/A
5.6.6.2	Test Method Resistance.....		N/A
5.6.7	Reliable earthing		N/A
5.7	Prospective touch voltage, touch current and protective conductor current		P

IEC 62368-1			
Clause	Requirement + Test	Result - Remark	Verdict
5.7.2	Measuring devices and networks	Figure 4 & Figure 5 of IEC 60990 was used in determining of the value.	P
5.7.2.1	Measurement of touch current .....	(See appended table 5.2.2.2, 5.7.2.2, 5.7.4)	P
5.7.2.2	Measurement of prospective touch voltage		P
5.7.3	Equipment set-up, supply connections and earth connections	Clause 4, 5.3 and 5.4 of IEC 60990:1999 applied.	P
	System of interconnected equipment (separate connections/single connection).....	Single equipment.	—
	Multiple connections to mains (one connection at a time/simultaneous connections).....	Single connection.	—
5.7.4	Earthed conductive accessible parts .....	Class II equipment.	N/A
5.7.5	Protective conductor current		N/A
	Supply Voltage (V).....		—
	Measured current (mA).....		—
	Instructional Safeguard.....		N/A
5.7.6	Prospective touch voltage and touch current due to external circuits	No external circuits.	N/A
5.7.6.1	Touch current from coaxial cables		N/A
5.7.6.2	Prospective touch voltage and touch current from external circuits		N/A
5.7.7	Summation of touch currents from external circuits	No external circuits.	N/A
	a) Equipment with earthed external circuits Measured current (mA).....		N/A
	b) Equipment whose external circuits are not referenced to earth. Measured current (mA).....		N/A

<b>6</b>	<b>ELECTRICALLY- CAUSED FIRE</b>		P
6.2	Classification of power sources (PS) and potential ignition sources (PIS)		P
6.2.2	Power source circuit classifications	PS (power source) classification determined by measuring the maximum power in Figures 34 and 35 for load and power source circuits.	P
6.2.2.1	General	See the following details.	P
6.2.2.2	Power measurement for worst-case load fault ..	(See appended table 6.2.2)	P
6.2.2.3	Power measurement for worst-case power source fault .....	(See appended table 6.2.2)	P
6.2.2.4	PS1 .....	(See appended table 6.2.2)	P



IEC 62368-1			
Clause	Requirement + Test	Result - Remark	Verdict
6.2.2.5	PS2 .....	All secondary circuit inside enclosure is claimed as PS3	N/A
6.2.2.6	PS3 .....	All primary circuit inside enclosure is claimed as PS3	P
6.2.3	Classification of potential ignition sources	See the following details.	P
6.2.3.1	Arcing PIS .....	All circuit inside enclosure is claimed as Arcing PIS	P
6.2.3.2	Resistive PIS .....	All circuit inside enclosure is claimed as Resistive PIS	P
6.3	Safeguards against fire under normal operating and abnormal operating conditions		P
6.3.1 (a)	No ignition and attainable temperature value less than 90 % defined by ISO 871 or less than 300 °C for unknown materials .....	No ignition and no such temperature attained within the equipment. (See appended table 5.4.1.4, 6.3.2, 9.0, B.2.6)	P
6.3.1 (b)	Combustible materials outside fire enclosure	Only output wire and connector which comply with 6.4.5.	P
6.4	Safeguards against fire under single fault conditions		P
6.4.1	Safeguard Method	Method by control of fire spread applied, Fire enclosure provided.	P
6.4.2	Reduction of the likelihood of ignition under single fault conditions in PS1 circuits		N/A
6.4.3	Reduction of the likelihood of ignition under single fault conditions in PS2 and PS3 circuits		N/A
6.4.3.1	General		N/A
6.4.3.2	Supplementary Safeguards		N/A
	Special conditions if conductors on printed boards are opened or peeled		N/A
6.4.3.3	Single Fault Conditions :		N/A
	Special conditions for temperature limited by fuse		N/A
6.4.4	Control of fire spread in PS1 circuits		P
6.4.5	Control of fire spread in PS2 circuits	Compliance detailed as follows: <ul style="list-style-type: none"> <li>- <u>Printed board</u>: rated min. V-1</li> <li>- <u>Wire insulation (tubing)</u>: complying with Clause 6 (See Table 4.1.2 for wiring used).</li> <li>- <u>All other components</u>: at least V-2 except for mounted on min. V-1 material or small parts of combustible material.</li> <li>- <u>Isolating transformer</u>: complying with G.5.3.</li> </ul>	P

IEC 62368-1			
Clause	Requirement + Test	Result - Remark	Verdict
6.4.5.2	Supplementary safeguards .....	(See appended tables 4.1.2 and Annex G)	P
6.4.6	Control of fire spread in PS3 circuit	Compliance detailed as follows: – <u>Parts as in 6.4.5 above including wiring</u> – Fire enclosure rated V-0 used.	P
6.4.7	Separation of combustible materials from a PIS	Fire enclosure provided.	N/A
6.4.7.1	General .....		N/A
6.4.7.2	Separation by distance		N/A
6.4.7.3	Separation by a fire barrier	No specific barrier provided.	N/A
6.4.8	Fire enclosures and fire barriers	See below.	P
6.4.8.1	Fire enclosure and fire barrier material properties	The V-0 material is used for the fire enclosure (overall enclosure).	P
6.4.8.2.1	Requirements for a fire barrier	No fire barrier used.	N/A
6.4.8.2.2	Requirements for a fire enclosure	The V-0 fire enclosure is used. See above.	P
6.4.8.3	Constructional requirements for a fire enclosure and a fire barrier		P
6.4.8.3.1	Fire enclosure and fire barrier openings		P
6.4.8.3.2	Fire barrier dimensions		N/A
6.4.8.3.3	Top Openings in Fire Enclosure: dimensions (mm) .....	No openings	N/A
	Needle Flame test		N/A
6.4.8.3.4	Bottom Openings in Fire Enclosure, condition met a), b) and/or c) dimensions (mm) .....	No opening	N/A
	Flammability tests for the bottom of a fire enclosure .....		N/A
6.4.8.3.5	Integrity of the fire enclosure, condition met: a), b) or c).....		N/A
6.4.8.4	Separation of PIS from fire enclosure and fire barrier distance (mm) or flammability rating .....	Fire enclosure is made of V-0 material.	N/A
6.5	Internal and external wiring		P
6.5.1	Requirements	Internal input wire and output cord provided	P
6.5.2	Cross-sectional area (mm <sup>2</sup> ) .....	See table 4.1.2	—
6.5.3	Requirements for interconnection to building wiring .....	(See Annex Q.)	N/A
6.6	Safeguards against fire due to connection to additional equipment		P

IEC 62368-1			
Clause	Requirement + Test	Result - Remark	Verdict
	External port limited to PS2 or complies with Clause Q.1	Output complies with Clause Q.1.	P

7	INJURY CAUSED BY HAZARDOUS SUBSTANCES		P
7.2	Reduction of exposure to hazardous substances	No hazardous chemicals within the equipment.	P
7.3	Ozone exposure	No ozone production within the equipment.	N/A
7.4	Use of personal safeguards (PPE)		N/A
	Personal safeguards and instructions .....		—
7.5	Use of instructional safeguards and instructions		N/A
	Instructional safeguard (ISO 7010).....		—
7.6	Batteries .....	No battery used.	N/A

8	MECHANICALLY-CAUSED INJURY		P
8.1	General	No moving parts in the equipment. See below regarding edges and corners.	P
8.2	Mechanical energy source classifications	MS1	P
8.3	Safeguards against mechanical energy sources		N/A
8.4	Safeguards against parts with sharp edges and corners	Edges and corners of the enclosure are rounded.	P
8.4.1	Safeguards		N/A
8.5	Safeguards against moving parts	No moving parts.	N/A
8.5.1	MS2 or MS3 part required to be accessible for the function of the equipment		N/A
8.5.2	Instructional Safeguard .....		—
8.5.4	Special categories of equipment comprising moving parts		N/A
8.5.4.1	Large data storage equipment		N/A
8.5.4.2	Equipment having electromechanical device for destruction of media		N/A
8.5.4.2.1	Safeguards and Safety Interlocks.....		N/A
8.5.4.2.2	Instructional safeguards against moving parts		N/A
	Instructional Safeguard .....		—
8.5.4.2.3	Disconnection from the supply		N/A
8.5.4.2.4	Probe type and force (N) .....		N/A

IEC 62368-1			
Clause	Requirement + Test	Result - Remark	Verdict
8.5.5	High Pressure Lamps		N/A
8.5.5.1	Energy Source Classification		N/A
8.5.5.2	High Pressure Lamp Explosion Test.....		N/A
8.6	Stability	Classification MS1 according to table 35, line 5 and no stability requirements.	N/A
8.6.1	Product classification		N/A
	Instructional Safeguard .....		—
8.6.2	Static stability		N/A
8.6.2.2	Static stability test		N/A
	Applied Force.....		—
8.6.2.3	Downward Force Test		N/A
8.6.3	Relocation stability test		N/A
	Unit configuration during 10 • tilt .....		—
8.6.4	Glass slide test		N/A
8.6.5	Horizontal force test (Applied Force).....		N/A
	Position of feet or movable parts.....		—
8.7	Equipment mounted to wall or ceiling		N/A
8.7.1	Mounting Means (Length of screws (mm) and mounting surface) .....		N/A
8.7.2	Direction and applied force .....		N/A
8.8	Handles strength		N/A
8.8.1	Classification		N/A
8.8.2	Applied Force .....		N/A
8.9	Wheels or casters attachment requirements		N/A
8.9.1	Classification		N/A
8.9.2	Applied force.....		—
8.10	Carts, stands and similar carriers		N/A
8.10.1	General		N/A
8.10.2	Marking and instructions		N/A
	Instructional Safeguard .....		—
8.10.3	Cart, stand or carrier loading test and compliance		N/A
	Applied force.....		—
8.10.4	Cart, stand or carrier impact test		N/A
8.10.5	Mechanical stability		N/A

IEC 62368-1			
Clause	Requirement + Test	Result - Remark	Verdict
	Applied horizontal force (N).....		—
8.10.6	Thermoplastic temperature stability (°C).....		N/A
8.11	Mounting means for rack mounted equipment		N/A
8.11.1	General		N/A
8.11.2	Product Classification		N/A
8.11.3	Mechanical strength test, variable N .....		N/A
8.11.4	Mechanical strength test 250N, including end stops		N/A
8.12	Telescoping or rod antennas.....	No such parts.	N/A
	Button/Ball diameter (mm) .....		—

<b>9</b>	<b>THERMAL BURN INJURY</b>		<b>P</b>
9.2	Thermal energy source classifications	No part considered to be accessible other than enclosure. The equipment evaluated by temperature test (see table 5.4.1.4).	P
9.3	Safeguard against thermal energy sources	Temperature of enclosure classed as TS1.	P
9.4	Requirements for safeguards		P
9.4.1	Equipment safeguard		P
9.4.2	Instructional safeguard .....		N/A

<b>10</b>	<b>RADIATION</b>		<b>N/A</b>
10.2	Radiation energy source classification		N/A
10.2.1	General classification		N/A
10.3	Protection against laser radiation		N/A
	Laser radiation that exists equipment:		—
	Normal, abnormal, single-fault.....		N/A
	Instructional safeguard.....		—
	Tool .....		—
10.4	Protection against visible, infrared, and UV radiation		N/A
10.4.1	General		N/A
10.4.1.a)	RS3 for Ordinary and instructed persons.....		N/A
10.4.1.b)	RS3 accessible to a skilled person .....		N/A
	Personal safeguard (PPE) instructional safeguard .....		—

IEC 62368-1			
Clause	Requirement + Test	Result - Remark	Verdict
10.4.1.c)	Equipment visible, IR, UV does not exceed RS1 .....		N/A
10.4.1.d)	Normal, abnormal, single-fault conditions :		N/A
10.4.1.e)	Enclosure material employed as safeguard is opaque .....		N/A
10.4.1.f)	UV attenuation .....		N/A
10.4.1.g)	Materials resistant to degradation UV:		N/A
10.4.1.h)	Enclosure containment of optical radiation.....		N/A
10.4.1.i)	Exempt Group under normal operating conditions.....		N/A
10.4.2	Instructional safeguard .....		N/A
10.5	Protection against x-radiation		N/A
10.5.1	X- radiation energy source that exists equipment .....		N/A
	Normal, abnormal, single fault conditions		N/A
	Equipment safeguards:		N/A
	Instructional safeguard for skilled person.....		N/A
10.5.3	Most unfavourable supply voltage to give maximum radiation:		—
	Abnormal and single-fault condition:		N/A
	Maximum radiation (pA/kg):		N/A
10.6	Protection against acoustic energy sources	Not such equipment.	N/A
10.6.1	General		N/A
10.6.2	Classification		N/A
	Acoustic output, dB(A).....		N/A
	Output voltage, unweighted r.m.s.....		N/A
10.6.4	Protection of persons		N/A
	Instructional safeguards .....		N/A
	Equipment safeguard prevent ordinary person to RS2.....		—
	Means to actively inform user of increase sound pressure .....		—
	Equipment safeguard prevent ordinary person to RS2.....		—
10.6.5	Requirements for listening devices (headphones, earphones, etc.)		N/A
10.6.5.1	Corded passive listening devices with analog input		N/A
	Input voltage with 94 dB(A) $L_{Aeq}$ acoustic		—

IEC 62368-1			
Clause	Requirement + Test	Result - Remark	Verdict
	pressure output .....		
10.6.5.2	Corded listening devices with digital input		N/A
	Maximum dB(A) .....		—
10.6.5.3	Cordless listening device		N/A
	Maximum dB(A) .....		—

<b>B</b>	<b>NORMAL OPERATING CONDITION TESTS, ABNORMAL OPERATING CONDITION TESTS AND SINGLE FAULT CONDITION TESTS</b>		<b>P</b>
B.2	Normal Operating Conditions		P
B.2.1	General requirements:	(See summary of testing for tested models, each loaded according to its output ratings. See also appended table B.2.5.)	P
	Audio Amplifiers and equipment with audio amplifiers .....	Not such equipment.	N/A
B.2.3	Supply voltage and tolerances	+10 % and -10 % considered.	P
B.2.5	Input test .....	(See appended table B.2.5)	P
B.3	Simulated abnormal operating conditions		P
B.3.1	General requirements:	(See appended table B.3)	P
B.3.2	Covering of ventilation openings		N/A
B.3.3	D.C. mains polarity test	The EUT is not connected to a D.C. mains	N/A
B.3.4	Setting of voltage selector:	No voltage selector was used.	N/A
B.3.5	Maximum load at output terminals:	(See appended table B.3)	P
B.3.6	Reverse battery polarity	No battery within the EUT	N/A
B.3.7	Abnormal operating conditions as specified in Clause E.2.	Not such equipment.	N/A
B.3.8	Safeguards functional during and after abnormal operating conditions	All safeguards remained effective.	P
B.4	Simulated single fault conditions		P
B.4.2	Temperature controlling device open or short-circuited:	No such device used.	N/A
B.4.3	Motor tests	No motors used.	N/A
B.4.3.1	Motor blocked or rotor locked increasing the internal ambient temperature :		N/A
B.4.4	Short circuit of functional insulation	See below.	P
B.4.4.1	Short circuit of clearances for functional insulation	(See appended table B.4)	P
B.4.4.2	Short circuit of creepage distances for functional insulation	(See appended table B.4)	P

IEC 62368-1			
Clause	Requirement + Test	Result - Remark	Verdict
B.4.4.3	Short circuit of functional insulation on coated printed boards	No coated printed boards used.	N/A
B.4.5	Short circuit and interruption of electrodes in tubes and semiconductors	(See appended table B.4 for faults on semiconductor components)	P
B.4.6	Short circuit or disconnect of passive components	(See appended table B.4)	P
B.4.7	Continuous operation of components	The EUT is continuous operating type and no such components intended for short time operation or intermittent operation	N/A
B.4.8	Class 1 and Class 2 energy sources within limits during and after single fault conditions		P
B.4.9	Battery charging under single fault conditions....	No battery involved in the EUT	N/A
<b>C</b>	<b>UV RADIATION</b>		N/A
C.1	Protection of materials in equipment from UV radiation	No UV generated from the equipment.	N/A
C.1.2	Requirements		N/A
C.1.3	Test method		N/A
C.2	UV light conditioning test		N/A
C.2.1	Test apparatus		N/A
C.2.2	Mounting of test samples		N/A
C.2.3	Carbon-arc light-exposure apparatus		N/A
C.2.4	Xenon-arc light exposure apparatus		N/A
<b>D</b>	<b>TEST GENERATORS</b>		P
D.1	Impulse test generators		P
D.2	Antenna interface test generator		N/A
D.3	Electronic pulse generator		N/A
<b>E</b>	<b>TEST CONDITIONS FOR EQUIPMENT CONTAINING AUDIO AMPLIFIERS</b>		N/A
E.1	Audio amplifier normal operating conditions	Not such equipment.	N/A
	Audio signal voltage (V).....		—
	Rated load impedance ( $\Omega$ ) .....		—
E.2	Audio amplifier abnormal operating conditions		N/A



IEC 62368-1			
Clause	Requirement + Test	Result - Remark	Verdict
<b>F</b>	<b>EQUIPMENT MARKINGS, INSTRUCTIONS, AND INSTRUCTIONAL SAFEGUARDS</b>		P
F.1	General requirements	See below.	P
	Instructions – Language .....	English and Germany	—
F.2	Letter symbols and graphical symbols		P
F.2.1	Letter symbols according to IEC60027-1	Letter symbols for quantities and units are complied with IEC 60027-1.	N/A
F.2.2	Graphic symbols IEC, ISO or manufacturer specific	Graphical symbols are complied with IEC 60417, ISO 3864-2, ISO 7000 or ISO 7010.	P
F.3	Equipment markings		P
F.3.1	Equipment marking locations	The required marking is located on the enclosure of the equipment and is easily visible.	P
F.3.2	Equipment identification markings	See copy of marking plate.	P
F.3.2.1	Manufacturer identification .....	See copy of marking plate.	—
F.3.2.2	Model identification .....	See model list.	—
F.3.3	Equipment rating markings	See the following details.	P
F.3.3.1	Equipment with direct connection to mains	The equipment is direct connected to AC mains, see F.3.3.3 to F.3.3.6.	P
F.3.3.2	Equipment without direct connection to mains		N/A
F.3.3.3	Nature of supply voltage .....	AC	—
F.3.3.4	Rated voltage.....	See copy of marking plate.	—
F.3.3.4	Rated frequency.....	See copy of marking plate.	—
F.3.3.6	Rated current or rated power.....	See copy of marking plate.	—
F.3.3.7	Equipment with multiple supply connections	Only one mains supply connection provided.	N/A
F.3.4	Voltage setting device	No voltage setting device.	N/A
F.3.5	Terminals and operating devices	See below.	P
F.3.5.1	Mains appliance outlet and socket-outlet markings:	No outlet used.	N/A
F.3.5.2	Switch position identification marking:	No switch used.	N/A
F.3.5.3	Replacement fuse identification and rating markings ..... :	“F1: T2AL OR T3.15AL 250V OR 3.3 OHM 2W” marked near fuse resistor on PCB. However, the fuse resistor is not intended to be replaceable.	P
F.3.5.4	Replacement battery identification marking:	No such battery on the equipment. See sub-clause F.5	N/A

IEC 62368-1			
Clause	Requirement + Test	Result - Remark	Verdict
F.3.5.5	Terminal marking location		N/A
F.3.6	Equipment markings related to equipment classification	See below.	P
F.3.6.1	Class I Equipment	Class II equipment.	N/A
F.3.6.1.1	Protective earthing conductor terminal		N/A
F.3.6.1.2	Neutral conductor terminal		N/A
F.3.6.1.3	Protective bonding conductor terminals		N/A
F.3.6.2	Class II equipment (IEC60417-5172)	Symbol IEC 60417-5172 used.	P
F.3.6.2.1	Class II equipment with or without functional earth	See above	P
F.3.6.2.2	Class II equipment with functional earth terminal marking		N/A
F.3.7	Equipment IP rating marking .....	IPX0.	—
F.3.8	External power supply output marking	See copy of marking plate.	P
F.3.9	Durability, legibility and permanence of marking	Marking is considered to be legible and easily discernible. See also the following details.	P
F.3.10	Test for permanence of markings	The label was subjected to the permanence of marking test. The label was rubbed with cloth soaked with water for 15 sec. And then again for 15 sec. With the cloth soaked with petroleum spirit. After this test there was no damage to the label. The marking on the label did not fade. There was no curling and lifting of the label edge. After each test, the marking remained legible.	P
F.4	Instructions		P
	a) Equipment for use in locations where children not likely to be present - marking		N/A
	b) Instructions given for installation or initial use	user manual was available	P
	c) Equipment intended to be fastened in place		N/A
	d) Equipment intended for use only in restricted access area		N/A
	e) Audio equipment terminals classified as ES3 and other equipment with terminals marked in accordance F.3.6.1	No such terminals provided.	N/A
	f) Protective earthing employed as safeguard		N/A

IEC 62368-1			
Clause	Requirement + Test	Result - Remark	Verdict
	g) Protective earthing conductor current exceeding ES2 limits		N/A
	h) Symbols used on equipment	No such symbols used as a safeguard considered.	N/A
	i) Permanently connected equipment not provided with all-pole mains switch	Not permanently connected equipment.	N/A
	j) Replaceable components or modules providing safeguard function	No such markings.	N/A
F.5	Instructional safeguards	No instructional safeguard is considered as necessary.	N/A
	Where "instructional safeguard" is referenced in the test report it specifies the required elements, location of marking and/or instruction	No instructional safeguard required in the equipment.	N/A

<b>G</b>	<b>COMPONENTS</b>		P
<b>G.1</b>	<b>Switches</b>		N/A
G.1.1	General requirements	No switch used.	N/A
G.1.2	Ratings, endurance, spacing, maximum load		N/A
<b>G.2</b>	<b>Relays</b>		N/A
G.2.1	General requirements	No relay used.	N/A
G.2.2	Overload test		N/A
G.2.3	Relay controlling connectors supply power		N/A
G.2.4	Mains relay, modified as stated in G.2		N/A
<b>G.3</b>	<b>Protection Devices</b>		P
G.3.1	Thermal cut-offs	No thermal cut-off used.	N/A
G.3.1.1a) &b)	Thermal cut-outs separately approved according to IEC 60730 with conditions indicated in a) & b)		N/A
G.3.1.1c)	Thermal cut-outs tested as part of the equipment as indicated in c)		N/A
G.3.1.2	Thermal cut-off connections maintained and secure		N/A
G.3.2	Thermal links		N/A
G.3.2.1a)	Thermal links separately tested with IEC 60691	No thermal link used.	N/A
G.3.2.1b)	Thermal links tested as part of the equipment		N/A
	Aging hours (H):		—
	Single Fault Condition:		—
	Test Voltage (V) and Insulation Resistance ( $\Omega$ ):		—
G.3.3	PTC Thermistors	No PTC thermistor used.	N/A

IEC 62368-1			
Clause	Requirement + Test	Result - Remark	Verdict
G.3.4	Overcurrent protection devices		P
G.3.5	Safeguards components not mentioned in G.3.1 to G.3.5		P
G.3.5.1	Non-resettable devices suitably rated and marking provided	See F.3.5.3	P
G.3.5.2	Single faults conditions .....	(See appended Table B.4)	P
<b>G.4</b>	<b>Connectors</b>		P
G.4.1	Spacings		N/A
G.4.2	Mains connector configuration .....	Refer to sub-clause 4.7	P
G.4.3	Plug is shaped that insertion into mains socket-outlets or appliance coupler is unlikely	Output connector with a shape that insert into mains connector is unlikely to occur.	P
<b>G.5</b>	<b>Wound Components</b>		P
G.5.1	Wire insulation in wound components.....	Approved Insulated wire used as Reinforced insulation for secondary winding of T1.	P
G.5.1.2 a)	Two wires in contact inside wound component, angle between 45° and 90°	Physical separation provided by tape.	P
G.5.1.2 b)	Construction subject to routine testing		N/A
G.5.2	Endurance test on wound components		N/A
G.5.2.1	General test requirements		N/A
G.5.2.2	Heat run test		N/A
	Time (s).....		—
	Temperature (°C).....		—
G.5.2.3	Wound Components supplied by mains		N/A
<b>G.5.3</b>	<b>Transformers</b>		P
G.5.3.1	Requirements applied (IEC61204-7, IEC61558-1/-2, and/or IEC62368-1):	The transformer meets the requirements given in G.5.3.2 and G.5.3.3.	P
	Position:	T1	—
	Method of protection :	See G.5.3.3.	—
G.5.3.2	Insulation	Primary windings and secondary windings are separated by Reinforced insulation (The core is considered as primary part as it is not isolated from Primary)	P
	Protection from displacement of windings .....	By bobbin and insulating tape	—
G.5.3.3	Overload test:	(See appended table B.3)	P
G.5.3.3.1	Test conditions	Tested in the complete equipment as an SMPS.	P

IEC 62368-1			
Clause	Requirement + Test	Result - Remark	Verdict
G.5.3.3.2	Winding Temperatures testing in the unit	(See appended table B.)	P
G.5.3.3.3	Winding Temperatures - Alternative test method	Alternative test method was not considered.	N/A
<b>G.5.4</b>	<b>Motors</b>		N/A
G.5.4.1	General requirements	No motor used.	N/A
	Position .....		—
G.5.4.2	Test conditions		N/A
G.5.4.3	Running overload test		N/A
G.5.4.4	Locked-rotor overload test		N/A
	Test duration (days) .....		—
G.5.4.5	Running overload test for d.c. motors in secondary circuits		N/A
G.5.4.5.2	Tested in the unit		N/A
	Electric strength test (V) .....		—
G.5.4.5.3	Tested on the Bench - Alternative test method; test time (h) .....		N/A
	Electric strength test (V) .....		—
G.5.4.6	Locked-rotor overload test for d.c. motors in secondary circuits		N/A
G.5.4.6.2	Tested in the unit		N/A
	Maximum Temperature .....		N/A
	Electric strength test (V) .....		N/A
G.5.4.6.3	Tested on the bench - Alternative test method; test time (h) .....		N/A
	Electric strength test (V) .....		N/A
G.5.4.7	Motors with capacitors		N/A
G.5.4.8	Three-phase motors		N/A
G.5.4.9	Series motors		N/A
	Operating voltage .....		—
<b>G.6</b>	<b>Wire Insulation</b>		P
G.6.1	General	Triple insulated winding in T1 secondary windings used as reinforced safeguard in the isolating transformer that has separately complied with Annex J.	P
G.6.2	Solvent-based enamel wiring insulation	Insulation does not rely on solvent-based enamel.	P
<b>G.7</b>	<b>Mains supply cords</b>		N/A
G.7.1	General requirements	Direct plug-in product.	N/A

IEC 62368-1			
Clause	Requirement + Test	Result - Remark	Verdict
	Type .....		—
	Rated current (A) .....		—
	Cross-sectional area (mm <sup>2</sup> ), (AWG) .....		—
G.7.2	Compliance and test method		N/A
G.7.3	Cord anchorages and strain relief for non-detachable power supply cords		N/A
G.7.3.2	Cord strain relief		N/A
G.7.3.2.1	Requirements		N/A
	Strain relief test force (N) .....		—
G.7.3.2.2	Strain relief mechanism failure	Class II equipment.	N/A
G.7.3.2.3	Cord sheath or jacket position, distance (mm)...		—
G.7.3.2.4	Strain relief comprised of polymeric material		N/A
G.7.4	Cord Entry .....		N/A
G.7.5	Non-detachable cord bend protection		N/A
G.7.5.1	Requirements		N/A
G.7.5.2	Mass (g) .....		—
	Diameter (m) .....		—
	Temperature (°C) .....		—
G.7.6	Supply wiring space		N/A
G.7.6.2	Stranded wire	No such wire.	N/A
G.7.6.2.1	Test with 8 mm strand		N/A
<b>G.8</b>	<b>Varistors</b>		N/A
G.8.1	General requirements	Not used	N/A
G.8.2	Safeguard against shock		N/A
G.8.3	Safeguard against fire		N/A
G.8.3.2	Varistor overload test .....		N/A
G.8.3.3	Temporary overvoltage .....		N/A
<b>G.9</b>	<b>Integrated Circuit (IC) Current Limiters</b>		N/A
G.9.1 a)	Manufacturer defines limit at max. 5A.	No IC current limiter provided within the equipment.	N/A
G.9.1 b)	Limiters do not have manual operator or reset		N/A
G.9.1 c)	Supply source does not exceed 250 VA .....		—
G.9.1 d)	IC limiter output current (max. 5A) .....		—
G.9.1 e)	Manufacturers' defined drift .....		—
G.9.2	Test Program 1		N/A
G.9.3	Test Program 2		N/A

IEC 62368-1			
Clause	Requirement + Test	Result - Remark	Verdict
G.9.4	Test Program 3		N/A
<b>G.10</b>	<b>Resistors</b>		N/A
G.10.1	General requirements	No such resistor as safeguard used	N/A
G.10.2	Resistor test		N/A
G.10.3	Test for resistors serving as safeguards between the mains and an external circuit consisting of a coaxial cable		N/A
G.10.3.1	General requirements		N/A
G.10.3.2	Voltage surge test		N/A
G.10.3.3	Impulse test		N/A
<b>G.11</b>	<b>Capacitor and RC units</b>		P
G.11.1	General requirements	Capacitors used in accordance with their rating and complied with subclasses of IEC 60384-14. (see appended table 4.1.2)	P
G.11.2	Conditioning of capacitors and RC units	(see appended table 4.1.2)	P
G.11.3	Rules for selecting capacitors	The selection followed with tables G.9 and G.12.	P
<b>G.12</b>	<b>Optocouplers</b>		N/A
	Optocouplers comply with IEC 60747-5-5:2007 Spacing or Electric Strength Test (specify option and test results) .....		N/A
	Type test voltage $V_{ini}$ .....		—
	Routine test voltage, $V_{ini,b}$ .....		—
<b>G.13</b>	<b>Printed boards</b>		P
G.13.1	General requirements	See the following details.	P
G.13.2	Uncoated printed boards	The insulation between conductors on the outer surfaces of an uncoated printed board complied with the minimum clearance and creepage requirements	P
G.13.3	Coated printed boards	No coated printed board or multilayer board applied for within the equipment.	N/A
G.13.4	Insulation between conductors on the same inner surface		N/A
	Compliance with cemented joint requirements (Specify construction) .....		—
G.13.5	Insulation between conductors on different surfaces		N/A

<b>IEC 62368-1</b>			
Clause	Requirement + Test	Result - Remark	Verdict
	Distance through insulation.....		N/A
	Number of insulation layers (pcs) .....		—
G.13.6	Tests on coated printed boards		N/A
G.13.6.1	Sample preparation and preliminary inspection		N/A
G.13.6.2a)	Thermal conditioning		N/A
G.13.6.2b)	Electric strength test		N/A
G.13.6.2c)	Abrasion resistance test		N/A
<b>G.14</b>	<b>Coating on components terminals</b>		N/A
G.14.1	Requirements .....	No coating on component terminals considered to affect creepage or clearances.	N/A
<b>G.15</b>	<b>Liquid filled components</b>		N/A
G.15.1	General requirements	No such device provided within the equipment.	N/A
G.15.2	Requirements		N/A
G.15.3	Compliance and test methods		N/A
G.15.3.1	Hydrostatic pressure test		N/A
G.15.3.2	Creep resistance test		N/A
G.15.3.3	Tubing and fittings compatibility test		N/A
G.15.3.4	Vibration test		N/A
G.15.3.5	Thermal cycling test		N/A
G.15.3.6	Force test		N/A
G.15.4	Compliance		N/A
<b>G.16</b>	<b>IC including capacitor discharge function (ICX)</b>		N/A
a)	Humidity treatment in accordance with sc5.4.8 – 120 hours		N/A
b)	Impulse test using circuit 2 with $U_c =$ to transient voltage .....		N/A
C1)	Application of ac voltage at 110% of rated voltage for 2.5 minutes		N/A
C2)	Test voltage :		—
D1)	10,000 cycles on and off using capacitor with smallest capacitance resistor with largest resistance specified by manufacturer		N/A
D2)	Capacitance .....		—
D3)	Resistance .....		—



IEC 62368-1			
Clause	Requirement + Test	Result - Remark	Verdict

<b>H</b>	<b>CRITERIA FOR TELEPHONE RINGING SIGNALS</b>		N/A
H.1	General	No telephone ringing signal generated within the equipment.	N/A
H.2	Method A		N/A
H.3	Method B		N/A
H.3.1	Ringling signal		N/A
H.3.1.1	Frequency (Hz) .....		—
H.3.1.2	Voltage (V) .....		—
H.3.1.3	Cadence; time (s) and voltage (V) .....		—
H.3.1.4	Single fault current (mA):.....		—
H.3.2	Tripping device and monitoring voltage .....		N/A
H.3.2.1	Conditions for use of a tripping device or a monitoring voltage complied with		N/A
H.3.2.2	Tripping device		N/A
H.3.2.3	Monitoring voltage (V).....		—

<b>J</b>	<b>INSULATED WINDING WIRES FOR USE WITHOUT INTERLEAVED INSULATION</b>		P
	General requirements	Approved triple insulated wire used. See appended table 4.1.2.	P

<b>K</b>	<b>SAFETY INTERLOCKS</b>		N/A
K.1	General requirements	No safety interlock provided.	N/A
K.2	Components of safety interlock safeguard mechanism .....		N/A
K.3	Inadvertent change of operating mode		N/A
K.4	Interlock safeguard override		N/A
K.5	Fail-safe		N/A
	Compliance .....		N/A
K.6	Mechanically operated safety interlocks		N/A
K.6.1	Endurance requirement		N/A
K.6.2	Compliance and Test method .....		N/A
K.7	Interlock circuit isolation		N/A
K.7.1	Separation distance for contact gaps & interlock circuit elements (type and circuit location) .....		N/A
K.7.2	Overload test, Current (A) .....		N/A

IEC 62368-1			
Clause	Requirement + Test	Result - Remark	Verdict
K.7.3	Endurance test		N/A
K.7.4	Electric strength test .....		N/A

<b>L</b>	<b>DISCONNECT DEVICES</b>		<b>P</b>
L.1	General requirements	AC mains plug used as disconnect device.	P
L.2	Permanently connected equipment		N/A
L.3	Parts that remain energized	When AC plug is disconnected no hazardous voltage in the equipment.	P
L.4	Single phase equipment	The mains plug disconnects both poles simultaneously.	P
L.5	Three-phase equipment		N/A
L.6	Switches as disconnect devices		N/A
L.7	Plugs as disconnect devices	See above	P
L.8	Multiple power sources	Only one a.c. mains connection.	N/A

<b>M</b>	<b>EQUIPMENT CONTAINING BATTERIES AND THEIR PROTECTION CIRCUITS</b>		<b>N/A</b>
M.1	General requirements	No battery used.	N/A
M.2	Safety of batteries and their cells		N/A
M.2.1	Requirements		N/A
M.2.2	Compliance and test method (identify method) ..		--
M.3	Protection circuits		N/A
M.3.1	Requirements		N/A
M.3.2	Tests		N/A
	- Overcharging of a rechargeable battery		N/A
	- Unintentional charging of a non-rechargeable battery		N/A
	- Reverse charging of a rechargeable battery		N/A
	- Excessive discharging rate for any battery		N/A
M.3.3	Compliance .....		--
M.4	Additional safeguards for equipment containing secondary lithium battery		N/A
M.4.1	General		N/A
M.4.2	Charging safeguards		N/A
M.4.2.1	Charging operating limits		N/A
M.4.2.2a)	Charging voltage, current and temperature .....		--

<b>IEC 62368-1</b>			
Clause	Requirement + Test	Result - Remark	Verdict
M.4.2.2 b)	Single faults in charging circuitry.....		--
M.4.3	Fire Enclosure		N/A
M.4.4	Endurance of equipment containing a secondary lithium battery		N/A
M.4.4.2	Preparation		N/A
M.4.4.3	Drop and charge/discharge function tests		N/A
	Drop		N/A
	Charge		N/A
	Discharge		N/A
M.4.4.4	Charge-discharge cycle test		N/A
M.4.4.5	Result of charge-discharge cycle test		N/A
M.5	Risk of burn due to short circuit during carrying		N/A
M.5.1	Requirement		N/A
M.5.2	Compliance and Test Method (Test of P.2.3)		N/A
M.6	Prevention of short circuits and protection from other effects of electric current		N/A
M.6.1	Short circuits		N/A
M.6.1.1	General requirements		N/A
M.6.1.2	Test method to simulate an internal fault		N/A
M.6.1.3	Compliance (Specify M.6.1.2 or alternative method) .....		N/A
M.6.2	Leakage current (mA) .....		N/A
M.7	Risk of explosion from lead acid and NiCd batteries		N/A
M.7.1	Ventilation preventing explosive gas concentration		N/A
M.7.2	Compliance and test method		N/A
M.8	Protection against internal ignition from external spark sources of lead acid batteries		N/A
M.8.1	General requirements		N/A
M.8.2	Test method		N/A
M.8.2.1	General requirements		N/A
M.8.2.2	Estimation of hypothetical volume Vz (m <sup>3</sup> /s) .....		--
M.8.2.3	Correction factors .....		--
M.8.2.4	Calculation of distance d (mm) .....		---
M.9	Preventing electrolyte spillage		N/A
M.9.1	Protection from electrolyte spillage		N/A

IEC 62368-1			
Clause	Requirement + Test	Result - Remark	Verdict
M.9.2	Tray for preventing electrolyte spillage		N/A
M.10	Instructions to prevent reasonably foreseeable misuse (Determination of compliance: inspection, data review; or abnormal testing) ...		N/A
<b>N</b>	<b>ELECTROCHEMICAL POTENTIALS</b>		N/A
	Metal(s) used.....	Class II equipment.	--
<b>O</b>	<b>MEASUREMENT OF CREEPAGE DISTANCES AND CLEARANCES</b>		P
	Figures O.1 to O.20 of this Annex applied .....	Considered.	—
<b>P</b>	<b>SAFEGUARDS AGAINST ENTRY OF FOREIGN OBJECTS AND SPILLAGE OF INTERNAL LIQUIDS</b>		P
P.1	General requirements		N/A
P.2.2	Safeguards against entry of foreign object	No openings of enclosure.	N/A
	Location and Dimensions (mm) .....		—
P.2.3	Safeguard against the consequences of entry of foreign object		N/A
P.2.3.1	Safeguards against the entry of a foreign object		N/A
	Openings in transportable equipment		N/A
	Transportable equipment with metalized plastic parts .....		N/A
P.2.3.2	Openings in transportable equipment in relation to metallized parts of a barrier or enclosure (identification of supplementary safeguard) .....		N/A
P.3	Safeguards against spillage of internal liquids	No such liquids.	N/A
P.3.1	General requirements		N/A
P.3.2	Determination of spillage consequences		N/A
P.3.3	Spillage safeguards		N/A
P.3.4	Safeguards effectiveness		N/A
P.4	Metallized coatings and adhesive securing parts	No such construction.	N/A
P.4.2 a)	Conditioning testing		N/A
	Tc (°C).....		—
	Tr (°C).....		—
	Ta (°C).....		—
P.4.2 b)	Abrasion testing .....		N/A
P.4.2 c)	Mechanical strength testing.....		N/A

IEC 62368-1			
Clause	Requirement + Test	Result - Remark	Verdict

Q	CIRCUITS INTENDED FOR INTERCONNECTION WITH BUILDING WIRING		P
Q.1	Limited power sources	See appended table Annex Q.1	P
Q.1.1 a)	Inherently limited output		N/A
Q.1.1 b)	Impedance limited output		P
	- Regulating network limited output under normal operating and simulated single fault condition	A regulating network limits the output in compliance with table Q.1 both under normal operating conditions and after any single fault.	P
Q.1.1 c)	Overcurrent protective device limited output		N/A
Q.1.1 d)	IC current limiter complying with G.9		N/A
Q.1.2	Compliance and test method	See appended table Annex Q.1	P
Q.2	Test for external circuits – paired conductor cable	No such circuit for connection to the EUT	N/A
	Maximum output current (A) .....		--
	Current limiting method .....		--

R	LIMITED SHORT CIRCUIT TEST		N/A
R.1	General requirements	No such consideration.	N/A
R.2	Determination of the overcurrent protective device and circuit		N/A
R.3	Test method Supply voltage (V) and short-circuit current (A). .....		N/A

S	TESTS FOR RESISTANCE TO HEAT AND FIRE		P
S.1	Flammability test for fire enclosures and fire barrier materials of equipment where the steady state power does not exceed 4 000 W	Approved fire enclosure with V-0 material used.	P
	Samples, material.....		—
	Wall thickness (mm).....		—
	Conditioning (□C).....		—
	Test flame according to IEC 60695-11-5 with conditions as set out		N/A
	- Material not consumed completely		N/A
	- Material extinguishes within 30s		N/A
	- No burning of layer or wrapping tissue		N/A
S.2	Flammability test for fire enclosure and fire barrier integrity		N/A

IEC 62368-1			
Clause	Requirement + Test	Result - Remark	Verdict
	Samples, material.....		—
	Wall thickness (mm).....		—
	Conditioning (□C).....		—
	Test flame according to IEC 60695-11-5 with conditions as set out		N/A
	Test specimen does not show any additional hole		N/A
S.3	Flammability test for the bottom of a fire enclosure		N/A
	Samples, material.....		—
	Wall thickness (mm).....		—
	Cheesecloth did not ignite		N/A
S.4	Flammability classification of materials	See Table 4.1.2 only.	P
S.5	Flammability test for fire enclosures and fire barrier materials of equipment where the steady state power does not exceed 4 000 W		N/A
	Samples, material.....		—
	Wall thickness (mm).....		—
	Conditioning (test condition), (°C).....		—
	Test flame according to IEC 60695-11-20 with conditions as set out		N/A
	After every test specimen was not consumed completely		N/A
	After fifth flame application, flame extinguished within 1 min		N/A

T	MECHANICAL STRENGTH TESTS		P
T.1	General requirements		P
T.2	Steady force test, 10 N .....	(See appended table T.2)	P
T.3	Steady force test, 30 N .....		N/A
T.4	Steady force test, 100 N .....	(See appended table T.4)	P
T.5	Steady force test, 250 N .....	(See appended table T.5)	N/A
T.6	Enclosure impact test	Direct plug in equipment.	N/A
	Fall test		N/A
	Swing test		N/A
T.7	Drop test .....	(See appended table T.7)	P
T.8	Stress relief test .....	(See appended table T.8)	P

<b>IEC 62368-1</b>			
Clause	Requirement + Test	Result - Remark	Verdict
T.9	Impact Test (glass)	No glass used.	N/A
T.9.1	General requirements		N/A
T.9.2	Impact test and compliance		N/A
	Impact energy (J).....		—
	Height (m).....		—
T.10	Glass fragmentation test.....		N/A
T.11	Test for telescoping or rod antennas	No such device.	N/A
	Torque value (Nm) .....		—
<b>U</b>	<b>MECHANICAL STRENGTH OF CATHODE RAY TUBES (CRT) AND PROTECTION AGAINST THE EFFECTS OF IMPLOSION</b>		N/A
U.1	General requirements	No CRT provided.	N/A
U.2	Compliance and test method for non-intrinsically protected CRTs		N/A
U.3	Protective Screen .....		N/A
<b>V</b>	<b>DETERMINATION OF ACCESSIBLE PARTS (FINGERS, PROBES AND WEDGES)</b>		P
V.1	Accessible parts of equipment	No access with test probes to any hazardous parts	P
V.2	Accessible part criterion		P

IEC 62368-1			
Clause	Requirement + Test	Result - Remark	Verdict

4.1.2	TABLE: List of critical components					P
Object/part No.	Manufacturer/ trademark	Type/model	Technical data	Standard (Edition / year)	Mark(s) of conformity <sup>1)</sup>	
Enclosure	Sabic Innovative Plastics Japan L L C	925U(GG), 945 (GG)	PC, V-0, 115°C, min. thickness 1.5mm	IEC/EN 62368-1 UL 94	UL & Tested with appliance	
(Alternate)	Covestro Deutschland AG.	FR6005 + (z)	PC, V-0, 105°C, min. thickness 1.5mm	IEC/EN 62368-1 UL 94	UL & Tested with appliance	
(Alternate)	LG Chemical	EF1006FH	PC, V-0, 115°C, minimum 1.5 mm thickness.	IEC/EN 62368-1 UL 94	UL & Tested with appliance	
(Alternate)	SABIC Japan L L C	CH6410(GG)	PC, V-0, 100°C, minimum 1.5 mm thickness.	IEC/EN 62368-1 UL 94	UL & Tested with appliance	
Pin sleeve / Plug holder	Sabic Innovative Plastics Japan L L C	925U(GG), 945 (GG)	PC, V-0, 115°C	IEC/EN 62368-1 UL 94	UL & Tested with appliance	
(Alternate)	Covestro Deutschland AG.	FR6005 + (z)	PC, V-0, 105°C	IEC/EN 62368-1 UL 94	UL & Tested with appliance	
(Alternate)	LG Chemical	EF1006FH	PC, V-0, 115°C	IEC/EN 62368-1 UL 94	UL & Tested with appliance	
(Alternate)	SABIC Japan L L C	CH6410(GG)	PC, V-0, 100°C	IEC/EN 62368-1 UL 94	UL & Tested with appliance	
European plug	GlobTek	EU fixed plug	0.5A, 250VAC	EN 50075:1990	Tested with appliance	
PCB	GUANGDONG HETONG TECHNOLOGY CO LTD	2V0, or CEM1	V-0 or better, min. 130°C	UL 796 IEC/EN 62368-1	UL E243157 Tested with appliance	
(Alternate)	Interchangeable	Interchangeable	V-1 or better, min. 130°C	UL 796	UL	
Output wire	Interchangeable	Interchangeable	Min. 80°C, min. 24AWG, VW-1, min. 30V	UL 758	UL	



IEC 62368-1					
Clause	Requirement + Test		Result - Remark	Verdict	
Object/part No.	Manufacturer/ trademark	Type/model	Technical data	Standard (Edition / year)	Mark(s) of conformity <sup>1)</sup>
Line choke (LF1) (for common mode, Optional)	Dee Van Enterprise Co Ltd	30C020080-xxxx ("xxxx" to denote the part number, can be any alphanumeric character for marketing purposes only.)	L1(1-2): Φ0.13mm * 80Ts; L2(4-3): Φ0.13mm*80Ts; min. 20mH, 130°C ,	IEC/EN 62368-1	Tested with appliance
- Bobbin	Sumitomo Bakelite Co Ltd	PM-9820	Phenolic, Rated V- 0, 150°C, min. 0.4 mm thick.	UL 94	UL
(Alternative	Chang Chun Plastics Co Ltd	T375J, T375HF, T200HF, T220NA	Phenolic, V-0, 150°C, Min. thickness 0.4mm	UL 94	UL
- tape	3M COMPANY ELECTRICAL MARKETS DIV (EMD)	1350F-1(b), 1350F-2(c)	130°C	UL 510	UL
(Alternative)	SYMBIO INC	35660 (a), 35661 (c), 35660Y(e)	130°C	UL 510	UL
- Magnet wire	Interchangeable	Interchangeable	130°C	UL 1446	UL
Line Choke (LF1 for differential mode) (alternative)	Interchangeable	Interchangeable	Min. 130°C, 470μH	UL 1446	UL
Choke(LF2) (Optional)	Dee Van Enterprise Co Ltd	30R056008-xxxx ("xxxx" to denote the part number, can be any alphanumeric character for marketing purposes only.)	L1(1-3): Φ0.50mm * 8Ts; L2(2-4): Φ0.13mm*8Ts; min. 30uH, 130°C ,	IEC/EN 62368-1	Tested with appliance
-Magnet wire	Interchangeable	Interchangeable	130°C	UL1446	UL
Current fuse (F1)	Littelfuse Wickmann Werke	392	T3.15AL, 250Vac	IEC/EN 60127-1 IEC/EN 60127-3	VDE UL

IEC 62368-1					
Clause	Requirement + Test		Result - Remark		Verdict
Object/part No.	Manufacturer/ trademark	Type/model	Technical data	Standard (Edition / year)	Mark(s) of conformity <sup>1)</sup>
(Alternate)	Conquer Electronics Co Ltd	PTU	T3.15AL, 250Vac	IEC/EN 60127-1 IEC/EN 60127-3	VDE UL
(Alternate)	Walter Electronic Co Ltd	ICP	T3.15AL, 250Vac	IEC/EN 60127-1 IEC/EN 60127-3	VDE UL
(Alternate)	Smart Electronics Inc.	SPT series	T3.15AL, 250Vac	IEC/EN 60127-1 IEC/EN 60127-3	VDE UL
(Alternate)	Littelfuse Inc	877	T3.15AL, 250Vac	IEC/EN 60127-1 IEC/EN 60127-3	VDE UL
(Alternate)	Everisland Electric Co.,Ltd. Andwalter Electric	2010	T3.15AL, 250Vac	IEC/EN 60127-1 IEC/EN 60127-3	VDE UL
(Alternate)	XC ELECTRONICS (SHENZHEN) CORP LTD	4T	T3.15AL, 250Vac	IEC/EN 60127-1 IEC/EN 60127-3	VDE UL
(Alternate)	XC ELECTRONICS (SHENZHEN) CORP LTD	5TE	T3.15AL, 250Vac	IEC/EN 60127-1 IEC/EN 60127-3	VDE UL
(Alternate)	Conquer Electronics Co Ltd	MST	T3.15AL, 250Vac	IEC/EN 60127-1 IEC/EN 60127-3	VDE UL
(Alternate)	Cooper Bussmann Llc	SS-5	T3.15AL, 250Vac	IEC/EN 60127-1 IEC/EN 60127-3	VDE UL
(Alternate)	Bel Fuse Inc	RST	T3.15AL, 250Vac	IEC/EN 60127-1 IEC/EN 60127-3	VDE UL
(Alternate)	Chi Lick Schurter Ltd	SPT	T3.15AL, 250Vac	IEC/EN 60127-1 IEC/EN 60127-3	VDE UL
(Alternate) (fuse resistor)	CHANG SHENG	RXF21	3.3Ω, 2W	IEC/EN 62368-1	Tested with appliance
(Alternate) (fuse resistor)	TZAI YUAN	KNF	3.3Ω, 2W	IEC/EN 62368-1	Tested with appliance
(Alternate) (fuse resistor)	Shenzhen Great	RXF series	3.3Ω, 2W	IEC/EN 62368-1	Tested with appliance
Varistor (MOV1) (Optional )	Thinking Electronic Industrial Co Ltd	TVR10471, TVR14471	Min. 300Vac, 105°C, (tested by UL for 6KV/3KA combination pulse), Coating rated V-0.	IEC/EN 61051-1 IEC/EN 61051-2 IEC/EN 60950-1 2nd Annex Q UL 1449	VDE UL

IEC 62368-1					
Clause	Requirement + Test		Result - Remark		Verdict
Object/part No.	Manufacturer/ trademark	Type/model	Technical data	Standard (Edition / year)	Mark(s) of conformity <sup>1)</sup>
(Alternate)	Centra Science Corp	CNR-10D471K, CNR-14D471K	Min. 300Vac, 105°C, (tested by UL for 2.5KV/1.25KA combination pulse), Coating rated V-0.	IEC/EN 61051-1 IEC/EN 61051-2 IEC/EN 60950-1 2nd Annex Q UL 1449	VDE UL
(Alternate)	Joyin Co Ltd	JVT10N471K, JVT14N471K,	Min. 300Vac, 125°C, (tested by UL for 6KV/3KA combination pulse), Coating rated V-0.	IEC/EN 61051-1 IEC/EN 61051-2 IEC/EN 60950-1 2nd Annex Q UL 1449	VDE UL
(Alternate)	Guangdong Fenghua Advanced Technology Holding Co Ltd. Xianhua New Sensitive Components Branch	FNR-10K471, FNR-14K471	Min. 300Vac, 105°C, (tested by UL for 6KV/3KA combination pulse), Coating rated V-0.	IEC/EN 61051-1 IEC/EN 61051-2 IEC/EN 60950-1 2nd Annex Q UL 1449	VDE UL
(Alternate)	Brightking (Shenzhen) Co Ltd	10D471K, 14D471K	Min. 300Vac, 105°C, (tested by UL for 6KV/3KA combination pulse), Coating rated V-0.	IEC/EN 61051-1 IEC/EN 61051-2 IEC/EN 60950-1 2nd Annex Q UL 1449	VDE UL
(Alternate)	Guangxi New Future Information Industry Co Ltd	10D471K, 14D471K	Min. 300Vac, 125°C, (tested by UL for 3KV/1.5KA combination pulse), Coating rated V-0.	IEC/EN 61051-1 IEC/EN 61051-2 IEC/EN 60950-1 2nd Annex Q UL 1449	VDE UL
(Alternate)	HONGZHI ENTERPRISES LTD	HEL10D471K(@), HEL14D471K(@)	Min. 300Vac, 105°C, (tested by UL for 6KV/3KA combination pulse), Coating rated V-0.	IEC/EN 61051-1 IEC/EN 61051-2 IEC/EN 60950-1 2nd Annex Q UL 1449	VDE UL
(Alternate)	Cerglass MFG Inc.	10D471K, 14D471K	Min. 300Vac, 125°C, (tested by UL for 3KV/1.5KA combination pulse), Coating rated V-0.	IEC/EN 61051-1 IEC/EN 61051-2 IEC/EN 60950-1 2nd Annex Q UL 1449	VDE UL
Electrolytic Cap (C1, C2)	Interchangeable	Interchangeable	4.7µF-22µF, 105° C, min.400V for all input voltage conditions, min.200V when input 100-120VAC	IEC/EN 62368-1	Tested with appliance

IEC 62368-1			
Clause	Requirement + Test	Result - Remark	Verdict

Object/part No.	Manufacturer/ trademark	Type/model	Technical data	Standard (Edition / year)	Mark(s) of conformity <sup>1)</sup>
Bridge Rectifier (BD1)	Interchangeable	Interchangeable	1.0A min., 600Vmin	IEC/EN 62368-1	Tested with appliance
Thermistor (NTC1) (Optional)	Interchangeable	Interchangeable	240Vac, min. 1A, min. 1.0 ohm at 25°C	IEC/EN 62368-1	Tested with appliance
IC (U1)	Interchangeable	Interchangeable	Min. 1.0A, 500V min.	IEC/EN 62368-1	Tested with appliance
Current sense resistor (R10, R11)	Interchangeable	Interchangeable	1.0 ohm min., 0.5W min	IEC/EN 62368-1	Tested with appliance
Electrolytic Cap (C7)	Interchangeable	Interchangeable	105°C	IEC/EN 62368-1	Tested with appliance
Y-Capacitor (CY1) (Optional)	Success Electronics Co., Ltd.	SE	Max. 2200pF, min. 250Vac, 125°C, Y1 type.	IEC/EN/UL 60384-14	VDE UL
(Alternate)	TDK Corporation	CD	Max. 2200pF, min. 250Vac, 125°C, Y1 type.	IEC/EN/UL 60384-14	VDE UL
(Alternate)	Murata Mfg Co Ltd	KX	Max. 2200pF, min. 250Vac, 125°C, Y1 type.	IEC/EN/UL 60384-14	VDE UL
(Alternate)	Welson Industrial Co Ltd	WD	Max. 2200pF, min. 250Vac, 125°C, Y1 type	IEC/EN/UL 60384-14	VDE UL
(Alternate)	Samwha Capacitor Samwha Capacitor	SD	Max. 2200pF, min. 250Vac, 125°C, Y1 type	IEC/EN/UL 60384-14	VDE UL
(Alternate)	Nanjing Yuyue Electronics Co., Ltd.	CT7	Max. 2200pF, min. 250Vac, 125°C, Y1 type	IEC/EN/UL 60384-14	VDE UL
(Alternate)	Yinan Don's Electronic Component Co	CT81	Max. 2200pF, min. 250Vac, 125°C, Y1 type	IEC/EN/UL 60384-14	VDE UL
(Alternate)	Dongguan Easy- gather Electronic Co., Ltd.	DCF	Max. 2200pF, min. 250Vac, 125°C, Y1 type	IEC/EN/UL 60384-14	VDE UL
(Alternate)	Shaanxi Huaxing Electronic Development Co. Ltd.	CT7Y1	Max. 2200pF, min. 250Vac, 125°C, Y1 type	IEC/EN/UL 60384-14	VDE UL
(Alternate)	South China Electronic Co., Ltd.	CY	Max. 2200pF, min. 250Vac, 125°C, Y1 type	IEC/EN/UL 60384-14	VDE UL

IEC 62368-1			
Clause	Requirement + Test	Result - Remark	Verdict

Object/part No.	Manufacturer/ trademark	Type/model	Technical data	Standard (Edition / year)	Mark(s) of conformity <sup>1)</sup>
Transformer (T1)	Dee Van Enterprise Co Ltd	90E121105-xxxx ("xxxx" to denote the part number, can be any alphanumeric character for marketing purposes only.) FOR 5.0-5.2V	Pri. Winding: (pin 2- pin 1) Φ0.27mmx1x72Ts Aux. winding: (pin 4- pin 5) Φ0.20mmx1x11Ts (pin 5- pin NC) Φ0.15mmx2x13Ts Sec. Winding (pin 6- pin 7): Φ0.50mmx2x4Ts , Class B	Applicable parts in IEC/EN 62368- 1 and according to IEC 60085	Tested with appliance
	Dee Van Enterprise Co Ltd	90E12PF11-xxxx ("xxxx" to denote the part number, can be any alphanumeric character for marketing purposes only.) for 12V	Pri. Winding: (pin 2- pin 1) Φ0.27mmx1x72Ts Aux. winding: (pin 4- pin 5) Φ0.15mmx2x10Ts (pin 5- pin NC) Φ0.11mmx2x11Ts Sec. Winding (pin 6- pin 7): Φ0.50mmx1x9Ts , Class B	Applicable parts in IEC/EN 62368- 1 and according to IEC 60085	Tested with appliance
Component used in T1					
-Bobbin	Sumitomo Bakelite Co., Ltd.	PM-9820, PM-9823	Phenolic, V-0, 150°C, min. 0.71 mm thickness	UL 94	UL
(Alternative)	Hitachi Chemical Co. , Ltd.	CP-J-8800	Phenolic, V-0, 150°C, Min. thickness 0.71mm	UL 94	UL
(Alternative)	Chang Chun Plastics Co Ltd	T375J, T375HF, T200HF, T220NA	Phenolic, V-0, 150°C, Min. thickness 0.71mm	UL 94	UL
- Magnet wire	Interchangeable	Interchangeable	130°C	UL1446	UL
-Triple insulate wire	Furukawa Electric Co Ltd	TEX-E	130°C	IEC/EN 62368-1	VDE UL
(Alternative)	Totoku Electric Co Ltd	TIW-2, TIW-2 SB, TIW-2LZ, TIW- 2LZ SB, TIW-2S	130°C	IEC/EN 60950-1	VDE UL
(Alternative)	Young Chang Silicone Co Ltd	STW-B	130°C	IEC/EN 60950-1	VDE UL

IEC 62368-1			
Clause	Requirement + Test	Result - Remark	Verdict

Object/part No.	Manufacturer/ trademark	Type/model	Technical data	Standard (Edition / year)	Mark(s) of conformity <sup>1)</sup>
(Alternative)	Dongguan Koshen Insulator Co.,Ltd.	TIW-B	130°C	IEC/EN 62368-1	VDE UL
(Alternative)	KBI Cosmolink Co Ltd	TIW-M	130°C	IEC/EN 62368-1	VDE UL
(Alternative)	Golden Ocean	XYW (B)	130°C	IEC/EN 60950-1	VDE UL
- Insulation tape	3M COMPANY ELECTRICAL MARKETS DIV (EMD)	1350F-1(b), 1350F-2(c)	130°C	UL 510	UL
(Alternative)	SYMBIO INC	35660 (a), 35661 (c), 35660Y(e)	130°C	UL 510	UL
(Alternative)	JINGJIANG YAHUA PRESSURE SENSITIVE GLUE CO LTD	CT* (b)(g), PZ* (b)	130°C	UL 510	UL
(Alternative)	JINGJIANG JINGYI ADHESIVE PRODUCT CO LTD	JY25-A (b)	130°C	UL 510	UL

**Supplementary information:**

<sup>1)</sup> Provided evidence ensures the agreed level of compliance. See OD-CB2039.

IEC 62368-1			
Clause	Requirement + Test	Result - Remark	Verdict

4.8.4, 4.8.5	TABLE: Lithium coin/button cell batteries mechanical tests		N/A
(The following mechanical tests are conducted in the sequence noted.)			
4.8.4.2	TABLE: Stress Relief test		---
	Part	Material	Oven Temperature (°C)
	--	--	--
4.8.4.3	TABLE: Battery replacement test		---
	Battery part no. ....		---
	Battery Installation/withdrawal		Battery Installation/Removal Cycle
			1
			2
			3
			4
			5
			6
			8
			9
			10
4.8.4.4	TABLE: Drop test		---
	Impact Area	Drop Distance	Drop No.
	--	--	1
	--	--	2
	--	--	3
4.8.4.5	TABLE: Impact		---
	Impacts per surface	Surface tested	Impact energy (Nm)
	--	--	--
4.8.4.6	TABLE: Crush test		---
	Test position	Surface tested	Crushing Force (N)
	--	--	--
Supplementary information: <b>Not Lithium coin/button cell batteries</b>			

4.8.5	TABLE: Lithium coin/button cell batteries mechanical test result		N/A
	Test position	Surface tested	Force (N)
	--	--	--
Supplementary information:			

IEC 62368-1			
Clause	Requirement + Test	Result - Remark	Verdict

<b>5.2</b>	<b>Table: Classification of electrical energy sources</b>	P
------------	---	---

#### 5.2.2.2 – Steady State Voltage and Current conditions

No.	Supply Voltage	Location (e.g. circuit designation)	Test conditions <sup>1)</sup>	Parameters			ES Class
				U (Vrms or Vpk)	I (A <sub>pk</sub> or A <sub>rms</sub> )	Hz	
1	264Va.c, 60Hz	Output (for U measure, '+' to '-', for I measure, the max. of '+' to earth & '-' to earth)	Normal	12.174V	0.053mA <sub>pk</sub>	--	ES1
			Abnormal (as table B.3)	12.122V	0.052mA <sub>pk</sub>	--	
			Single fault – SC/OC (as table B.4)	12.095V	0.18mA <sub>pk</sub>	--	
4	264Va.c, 60Hz	Enclosure	Normal	--	0.01mA <sub>pk</sub>	--	ES1
			Abnormal (as table B.3)	--	0.01mA <sub>pk</sub>	--	
			Single fault – SC/OC (as table B.4)	--	0.01mA <sub>pk</sub>	--	

#### 5.2.2.3 - Capacitance Limits

No.	Supply Voltage	Location (e.g. circuit designation)	Test conditions	Parameters		ES Class
				Capacitance, nF	U <sub>pk</sub> (V)	
--	--	--	Normal	--	--	--
			Abnormal	--	--	--
			Single fault – SC/OC	--	--	--

#### 5.2.2.4 - Single Pulses

No.	Supply Voltage	Location (e.g. circuit designation)	Test conditions	Parameters			ES Class
				Duration (ms)	U <sub>pk</sub> (V)	I <sub>pk</sub> (mA)	
--	--	--	Normal	--	--	--	--
			Abnormal	--	--	--	
			Single fault – SC/OC	--	--	--	

#### 5.2.2.5 - Repetitive Pulses

No.	Supply Voltage	Location (e.g. circuit designation)	Test conditions	Parameters			ES Class
				Off time (ms)	U <sub>pk</sub> (V)	I <sub>pk</sub> (mA)	
--	--	--	Normal	--	--	--	--
			Abnormal	--	--	--	



IEC 62368-1							
Clause	Requirement + Test			Result - Remark			Verdict
			Single fault – SC/OC	--	--	--	
Test Conditions: Normal – Full load and no load. Abnormal – Overload output Supplementary information: SC=Short Circuit, OC=Open Circuit							

IEC 62368-1						
Clause	Requirement + Test	Result - Remark			Verdict	
<b>5.4.1.4, 6.3.2, 9.0, B.2.6</b>	<b>TABLE: Temperature measurements</b>				P	
	Supply voltage (V) .....	90V/60Hz	264V/60Hz		—	
	Ambient T <sub>min</sub> (°C) .....	--	--		—	
	Ambient T <sub>max</sub> (°C) .....	--	--		—	
	T <sub>ma</sub> (°C) .....	--	--		—	
Maximum measured temperature T of part/at:		T (°C)			Allowed T <sub>max</sub> (°C)	
GT-86122-1212-W2E		Horizontal	Vertical	Horizontal	Vertical	--
Plug holder		--	52.1	49.6	49.3	Ref.
Varistor MOV1		--	78.7	67.5	69	105
Line chock of LF1 winding (Commen Mode Choke)		--	89	74.1	76.1	130
PCB near BD1		--	84.6	72.5	74.8	130
Electrolytic capacitor C2		--	89.1	82.4	94.4	105
PCB near U1		--	97.4	94	95.5	130
T1 winding		--	96.9	98.4	97.6	110
T1 core		--	96.2	97.0	98.5	110
Y-capacitor CY1 body		--	90.5	85.2	86.8	125
E-capacitor C7		--	87.8	84.4	85.8	105
Internal part of output cord		--	65.6	67.1	65.8	80
Plastic enclosure inside near T1		--	90.5	91.6	91.7	100
Plastic enclosure outside near T1		--	78.3	78.8	78.8	Ref.
Ambient		--	45.0	45.0	45.0	--
Consider for Thermal Energy source						
Enclosure inside near T1		--	70.5	71.6	71.7	Ref.
Enclosure outside near T1		--	58.3	58.8	58.8	77
Ambient		--	25.0	25.0	25.0	--
GT-86122-1212-W2E		Horizontal	Vertical	Horizontal	Vertical	--
Varistor MOV1		--	82.7	68.4	70.8	105
Line chock of LF1 winding (Differential Mode Choke)		--	105.6	78.6	80.7	110
E-capacitor C2		--	92.4	83.5	85.9	105
T1 winding		--	102.2	101.3	101.2	110
T1 core		--	99.2	98.4	98.4	110
LF2 winding		--	79.9	78.5	76.9	130

IEC 62368-1							
Clause	Requirement + Test			Result - Remark			Verdict
Plastic enclosure inside near T1	--	88.9	86	87.9	100		
Ambient	--	45.0	45.0	45.0	--		
GT-86122-1105.2-W2E	Horizontal	Vertical	Horizontal	Vertical	--		
Plug holder	--	52.1	50.1	49.8	Ref.		
Varistor MOV1	--	80.7	72.3	74	105		
Line chock of LF1 winding (Commen Mode Choke)	--	89.6	79	81.5	130		
PCB near BD1	--	86.9	77.4	78.8	130		
Electrolytic capacitor C2	--	90.9	88.8	90.9	105		
PCB near U1	--	98.9	98.9	101.1	130		
T1 winding	--	102.1	106.1	106.7	110		
T1 core	--	98.5	102.3	103	110		
LF2 winding	--	80.9	83	82.5	130		
Y-capacitor CY1 body	--	87.3	83.9	85.5	125		
E-capacitor C7	--	92.5	91.9	92.6	105		
Internal part of output cord	--	69.7	73.2	72	80		
Plastic enclosure inside near T1	--	93.2	96.2	97.4	100		
Plastic enclosure outside near T1	--	80.3	81.9	83.7	Ref.		
Ambient	--	45.0	45.0	45.0	--		
Consider for Thermal Energy source							
Plastic enclosure inside near T1	--	73.2	76.2	77.4	Ref.		
Plastic enclosure outside near T1	--	60.3	61.9	63.7	77		
Ambient	--	25.0	25.0	25.0	--		
Supplementary information: * Temperature limit for TS1 of accessible enclosure according to Table 38. Note 1: The apparatus was submitted and evaluated for maximum manufacturer's recommended ambient (T <sub>ma</sub> ) of 45°C. Note 2: The temperatures were measured under the worse case normal mode defined in clause B.2.1. Note 3: Temperature limits are calculated as follows: Winding components providing safety isolation: Class B → T <sub>max</sub> = 120 - 10=110°C							
Temperature T of winding:	t <sub>1</sub> (°C)	R <sub>1</sub> (Ω)	t <sub>2</sub> (°C)	R <sub>2</sub> (Ω)	T (°C)	Allowed T <sub>max</sub> (°C)	Insulation class
--	--	--	--	--	--	--	--

IEC 62368-1			
Clause	Requirement + Test	Result - Remark	Verdict

5.4.1.10.2	TABLE: Vicat softening temperature of thermoplastics		N/A
Penetration (mm) .....			—
Object/ Part No./Material	Manufacturer/trademark	T softening (°C)	
--	--	--	
supplementary information: --			

5.4.1.10.3	TABLE: Ball pressure test of the moplastics			P
Allowed impression diameter (mm) .....	≤ 2 mm			—
Object/Part No./Material	Manufacturer/trademark	Test temperature (°C)	Impression diameter (mm)	
Pin sleeve / plug holder	LG Chemical / EF1006FH	125	0.95	
Pin sleeve / plug holder	SABIC Japan L L C / 925U(GG)	125	0.95	
Pin sleeve / plug holder	Covestro Deutschland AG./ FR6005 + (z)	125	0.95	
Pin sleeve / plug holder	SABIC Japan L L C / 945(GG)	125	0.95	
Pin sleeve / plug holder	SABIC Japan L L C / CH6410(GG)	125	0.95	
Supplementary information: The bobbin material of transformer (T1) is phenolic, no test is needed.				

5.4.2.2, 5.4.2.4 and 5.4.3	TABLE: Minimum Clearances/Creepage distance						P
Clearance (cl) and creepage distance (cr) at/of/between:	Up (V)	U r.m.s. (V)	Frequency (kHz)	Required cl (mm)	cl (mm) <sup>2</sup>	Required <sup>3</sup> cr (mm)	cr (mm)
Line trace to Neutral trace before fuse resistor F1(B)*	420	250	<30	2.3	3.2	2.5	3.2
Trace of F1 different polarity (B)*	420	250	<30	2.3	2.9	2.5	2.9
L trace of F1 to Primary circuit after F1 (B)*	420	250	<30	2.3	2.9	2.5	2.9
Detachable plug portion L/N pin to accessible enclosure (R)*	420	250	<30	4.5	10.0	5.0	10.0
Primary part to accessible enclosure (R)*	420	250	<30	4.5	8.0	5.0	8.0
Primary to secondary traces under CY1(R)*	420	250	<30	4.5	6.6	5.0	6.6
Primary traces to secondary traces under T1(R)*	568	253	58.25	4.5	6.2	5.2	6.2
Transformer Pri. winding to secondary pin(R)*	568	253	58.25	4.5	8.0	5.2	10.0

IEC 62368-1							
Clause	Requirement + Test			Result - Remark			Verdict
Transformer core to secondary pin(R)*	568	253	58.25	4.5	8.0	5.2	8.0
Supplementary information:							
1) Unless otherwise specified, the worst conditions of Cl. & Cr. in above mentioned locations have been considered and listed.							
2) The internal wires are additionally fixed by glue or clamping.							
3) The Cl. was evaluated for altitude up to 5000m above sea level correction factor for clearance is 1.48.							
* B= Basic insulation, S=Supplementary insulation, R=Reinforced insulation.							

5.4.2.3	TABLE: Minimum Clearances distances using required withstand voltage			P
	Overvoltage Category (OV):			II
	Pollution Degree:			2
Clearance distanced between:		Required withstand voltage	Required cl (mm)	Measured cl (mm)
1)		2500V	2)	3)
Supplementary information:				
1) 2) 3) See table 5.4.2.2, 5.4.2.4 and 5.4.3 above.				

5.4.2.4	TABLE: Clearances based on electric strength test			N/A
Test voltage applied between:		Required cl (mm)	Test voltage (kV) peak/ r.m.s. / d.c.	Breakdown Yes / No
--		--	--	--
Supplementary information: Using procedure 2 to determine the clearance.				

5.4.4.2, 5.4.4.5 c) 5.4.4.9	TABLE: Distance through insulation measurements					P
Distance through insulation di at/of:	Peak voltage (V)	Frequency (Hz)	Material	Required DTI (mm)	DTI (mm)	
Enclosure	568	--	See appended table 4.1.2	0.4	<sup>1)</sup>	
Insulation sheet between Pri. & Sec.	568	--	See appended table 4.1.2	0.4	<sup>1)</sup>	
Supplementary information: <sup>1)</sup> See appended table 4.1.2						

IEC 62368-1			
Clause	Requirement + Test	Result - Remark	Verdict

5.4.9	TABLE: Electric strength tests			P
Test voltage applied between:	Voltage shape (AC, DC)	Test voltage (Vpeak)	Breakdown Yes / No	
Basic/supplementary:				
Line to Neutral (with fuse resistor disconnect)	DC	2500	No	
Reinforced:				
Unit primary to unit secondary (for unit)	DC	4000	No	
Unit primary to unit enclosure with metal foil (for unit)	DC	4000	No	
T1: Primary to secondary	DC	4000	No	
T1: Secondary to core	DC	4000	No	
One layer insulaton tape	DC	4000	No	
Supplementary information: Core of transformer T1 was considered as primary.				

5.5.2.2	TABLE: Stored discharge on capacitors					N/A
Supply Voltage (V), Hz	Test Location	Operating Condition (N, S)	Switch position On or off	Measured Voltage (after 2 seconds)	ES Classification	
--	--	--	--	--	--	
Supplementary information:						
X-capacitors installed for testing are:						
<input type="checkbox"/> bleeding resistor rating: see table 4.1.2 <input type="checkbox"/> ICX: Approval discharge IC						
Notes:						
A. Test Location:						
Phase to Neutral; Phase to Phase; Phase to Earth; and/or Neutral to Earth						
B. Operating condition abbreviations: N – Normal operating condition (e.g., normal operation, or open fuse); S –Single fault condition (Bleeder Resistor open circuit)						

5.6.6.2	TABLE: Resistance of protective conductors and terminations				N/A
Accessible part	Test current (A)	Duration (min)	Voltage drop (V)	Resistance (Ω)	
--	--	--	--	--	
Supplementary Information: Class II equipment.					

5.7.2.2, 5.7.4	TABLE: Earthed accessible conductive part		N/A
Supply voltage .....	264Vac		—
Location	Test conditions specified in 6.1 of IEC 60990 or Fault Condition No in IEC 60990 clause 6.2.2.1		Touch current (mA)

IEC 62368-1			
Clause	Requirement + Test	Result - Remark	Verdict
		through 6.2.2.8, except for 6.2.2.7	
--		1	N/A
--		2*	N/A
--		3	N/A
--		4	N/A
--		5	N/A
--		6	N/A
--		8	N/A
Notes:			
[1] Supply voltage is the anticipated maximum Touch Voltage			
[2] Earthed neutral conductor [Voltage differences less than 1% or more]			
[3] Specify method used for measurement as described in IEC 60990 sub-clause 4.3			
[4] IEC60990, sub-clause 6.2.2.7, Fault 7 not applicable.			
[5] (*) IEC60990, sub-clause 6.2.2.2 is not applicable if switch or disconnect device (e.g., appliance coupler) provided.			

6.2.2	Table: Electrical power sources (PS) measurements for classification				P
Source	Description	Measurement	Max Power after 3 s	Max Power after 5 s <sup>*)</sup>	PS Classification
GT-86122-1212-W2E					
Output	Normal operation	Power (W) :	13.25	--	PS1
		VA (V) :	11.96	--	
		IA (A) :	1.01	--	
Output	Abnormal operation	Power (W) :	13.25	--	PS1
		VA (V) :	11.96	--	
		IA (A) :	1.01	--	
Output	Short circuit (R11 SC, or U2 pin 1-8 SC)	Power (W) :	0#	--	PS1
		VA (V) :	0#	--	
		IA (A) :	0#	--	
Output	Short ciucuit (R1 SC)	Power (W) :	13.25	--	PS1
		VA (V) :	11.96	--	
		IA (A) :	1.01	--	
GT-86122-1105.2-W2E					
Output	Normal operation	Power (W) :	12.26	--	PS1
		VA (V) :	5.09	--	
		IA (A) :	2.39	--	
Output	Abnormal operation	Power (W) :	12.26	--	PS1
		VA (V) :	5.09	--	

IEC 62368-1				
Clause	Requirement + Test		Result - Remark	Verdict
		IA (A) :	2.39	--
Output	Short circuit (R11 SC, or U2 pin 1-8 SC)	Power (W) :	0#	--
		VA (V) :	0#	--
		IA (A) :	0#	--
Output	Short ciucuit (R1 SC)	Power (W) :	12.26	--
		VA (V) :	5.09	--
		IA (A) :	2.39	--
Supplementary information: # Unit shutdown immediately, F1 damage, no hazard.				

6.2.3.1	Table: Determination of Potential Ignition Sources (Arcing PIS)			P
Location	Open circuit voltage After 3 s (V <sub>p</sub> )	Measured r.m.s current (I <sub>rms</sub> )	Calculated value (V <sub>p</sub> × I <sub>rms</sub> )	Arcing PIS? Yes / No
See below	--	--	--	--
Supplementary information: <b>Considered arcing PIS in all primary and secondary circuit.</b> An Arcing PIS requires a minimum of 50 V (peak) a.c. or d.c. An Arcing PIS is established when the product of the open circuit voltage (V <sub>p</sub> ) and normal operating condition rms current (I <sub>rms</sub> ) is greater than 15.				



IEC 62368-1			
Clause	Requirement + Test	Result - Remark	Verdict

6.2.3.2	Table: Determination of Potential Ignition Sources (Resistive PIS)				P
Circuit Location (x-y)	Operating Condition (Normal / Describe Single Fault)	Measured wattage or VA During first 30 s (W / VA)	Measured wattage or VA After 30 s (W / VA)	Protective Circuit, Regulator, or PTC Operated? Yes / No (Comment)	Resistive PIS? Yes/No
--	--	--	--	--	--

Supplementary Information:

**Considered resistive PIS in all primary and secondary circuit.**

A combination of voltmeter, VA and ammeter IA may be used instead of a wattmeter.

A Resistive PIS: (a) dissipates more than 15 W, measured after 30 s of normal operation, or (b) under single fault conditions has either a power exceeding 100 W measured immediately after the introduction of the fault if electronic circuits, regulators or PTC devices are used, or has an available power exceeding 15 W measured 30 s after introduction of the fault.

8.5.5	TABLE: High Pressure Lamp	N/A
Description	Values	Energy Source Classification
Lamp type.....:		—
Manufacturer.....:		—
Cat no.....:		—
Pressure (cold) (MPa).....:		MS_
Pressure (operating) (MPa).....:		MS_
Operating time (minutes).....:		—
Explosion method.....:		—
Max particle length escaping enclosure (mm):.		MS_
Max particle length beyond 1 m (mm).....:		MS_
Overall result .....		
Supplementary information:		

B.2.5	TABLE: Input test						P
U (V)	I (A)	I rated (A)	P (W)	P rated (W)	Fuse No	I fuse (A)	Condition/status
GT-86122-1212-W2E							
90/50Hz	0.271	--	14.74	--	RF1	0.271	Rated load
90/60Hz	0.273	--	14.73	--	RF1	0.273	
100/50Hz	0.246	0.5	14.63	--	RF1	0.246	
100/60Hz	0.250	0.5	14.61	--	RF1	0.250	
120/50Hz	0.214	0.5	14.49	--	RF1	0.214	
120/60Hz	0.217	0.5	14.50	--	RF1	0.217	
132/50Hz	0.199	--	14.50	--	RF1	0.199	

IEC 62368-1						
Clause	Requirement + Test			Result - Remark		Verdict
132/60Hz	0.203	--	14.47	--	RF1	0.203
240/50Hz	0.135	0.5	14.41	--	RF1	0.135
240/60Hz	0.135	0.5	14.41	--	RF1	0.135
264/50Hz	0.127	--	14.48	--	RF1	0.127
264/60Hz	0.126	--	14.47	--	RF1	0.126
GT-86122-1105.2-W2E						
90/50Hz	0.253	--	13.74	--	RF1	0.253
90/60Hz	0.253	--	13.70	--	RF1	0.253
100/50Hz	0.230	0.5	13.56	--	RF1	0.230
100/60Hz	0.233	0.5	13.56	--	RF1	0.233
120/50Hz	0.200	0.5	13.52	--	RF1	0.200
120/60Hz	0.204	0.5	13.51	--	RF1	0.204
132/50Hz	0.189	--	13.46	--	RF1	0.189
132/60Hz	0.191	--	13.46	--	RF1	0.191
240/50Hz	0.128	0.5	13.46	--	RF1	0.128
240/60Hz	0.128	0.5	13.45	--	RF1	0.128
264/50Hz	0.121	--	13.55	--	RF1	0.121
264/60Hz	0.120	--	13.56	--	RF1	0.120
Supplementary information: The maximum measured current under rated voltage did not exceed 110% of the rated current.						

B.3		TABLE: Abnormal operating condition tests						P
Ambient temperature (°C) .....					25°C, if not specified		—	
Power source for EUT: Manufacturer, model/type, output rating :					--		—	
Component No.	Abnormal Condition	Supply voltage, (V)	Test time (ms)	Fuse no.	Fuse current, (A)	T-couple	Temp. (°C)	Observation
Output	S-C	264	5min	F1	0.011	--	--	The unit shut down immediately, no damage, no hazard.
Output(12V ) (LF1 for differential mode)	O-L	264	3hr 45min	F1	0.125-> 0.137-> 0.033	Type T	T1 winding measured: 104.2 °C max. correct to ambient 45°C	Unit shut down when output more than 1.10A

IEC 62368-1								
Clause	Requirement + Test					Result - Remark		Verdict
Transformer (T1) (LF1 for differential mode)	O-L	264	3hr 34min	F1	0.125-> 0.130-> 0.033<-> 0.024	Type T	T1 winding measured: 102.7 °C max. correct to ambient 45°C	(output 12V, 1A), Unit shut down when output more than 0.1A
Output (5.2V)	O-L	264	6hr 48min	F1	0.125-> 0.136-> 0.017-> 0.009	Type T	T1 winding measured: 110.4 °C max. correct to ambient 45°C	Unit shut down when output more than 2.5A

**Supplementary information:**

Test table is provided to record abnormal and fault conditions for all applicable energy sources including Thermal burn injury. Column "Abnormal/Fault." Specify if test condition by indicating "Abnormal" then the condition for a Clause B.3 test or "Single Fault" then the condition for Clause B.4.

1) S-C: Short-circuited; O-C: Open-circuited; O-L: Overloaded.

2) The test result shown all safeguards remained effective and didn't lead to a single fault condition during abnormal operating condition; In addition all safeguards complied with applicable requirements in this standard after restoration of normal operating conditions.

3) The test result showed no Class 1 or 2 energy source become Class 3 level during and after single fault condition.

4) The overloaded condition is applied according to annex G.5.3.3.

Winding Limit for T1: 175-10=165°C.

B.4		TABLE: Fault condition tests							P
Ambient temperature (°C) .....						22.7°C, if not specified		—	
Power source for EUT: Manufacturer, model/type, output rating :						--		—	
Component No.	Fault Condition	Supply voltage, (V)	Test time (ms)	Fuse no.	Fuse current, (A)	T-couple	Temp. (°C)	Observation	
MOV1	Sc	264	1s	F1	--	--	--	F1 opened immediately, no hazard.	
BD1 pin ~ to +	Sc	264	1s	F1	--	--	--	F1 opened immediately, no hazard.	
C2	Sc	264	1s	F1	--	--	--	F1 opened immediately, no hazard.	
R11	Sc	264	1s	F1	--	--	--	F1 opened immediately, no hazard.	

IEC 62368-1								
Clause	Requirement + Test				Result - Remark			Verdict
U1 pin 5 -1	Sc	264	1s	F1	--	--	--	F1 opened immediately, no hazard.
U1 pin 5 -4	Sc	264	1s	F1	--	--	--	F1 opened immediately, no hazard.
U2 pin 1-8	Sc	264	5min	F1	0.003	--	--	Unit shutdown immediately recoverable, no hazard.
T1 pin 1-2	Sc	264	5min	F1	0.004	--	--	Unit shutdown immediately recoverable, no hazard.
T1 pin 3-4	Sc	264	5min	F1	0.004	--	--	Unit shutdown immediately recoverable, no hazard.
T1 pin 5-6	Sc	264	5min	F1	0.004	--	--	Unit shutdown immediately recoverable, no hazard.
<p>Supplementary information:            Test table is provided to record abnormal and fault conditions for all applicable energy sources including Thermal burn injury. Column "Abnormal/Fault." Specify if test condition by indicating "Abnormal" then the condition for a Clause B.3 test or "Single Fault" then the condition for Clause B.4.</p> <p>1) S-C: Short-circuited; O-C: Open-circuited; O-L: Overloaded.            2) The test result shown all safeguards remained effective and didn't lead to a single fault condition during abnormal operating condition; In addition all safeguards complied with applicable requirements in this standard after restoration of normal operating conditions.            3) The test result showed no Class 1 or 2 energy source become Class 3 level during and after single fault condition.</p>								

IEC 62368-1			
Clause	Requirement + Test	Result - Remark	Verdict

Annex M			TABLE: Batteries							N/A
The tests of Annex M are applicable only when appropriate battery data is not available										N/A
Is it possible to install the battery in a reverse polarity position? .....										N/A
	Non-rechargeable batteries			Rechargeable batteries						
	Discharging		Un-intentional charging	Charging		Discharging		Reversed charging		
	Meas. current	Manuf. Specs.		Meas. current	Manuf. Specs.	Meas. current	Manuf. Specs.	Meas. current	Manuf. Specs.	
Max. current during normal condition	--	--	--	--	--	--	--	--	--	
Max. current during fault condition	--	--	--	--	--	--	--	--	--	
Test results:										Verdict
- Chemical leaks								--	--	
- Explosion of the battery								--	--	
- Emission of flame or expulsion of molten metal								--	--	
- Electric strength tests of equipment after completion of tests								--	--	
Supplementary information:										
--										

Annex M.4			Table: Additional safeguards for equipment containing secondary lithium batteries				N/A
Battery/Cell No.	Test conditions	Measurements			Observation		
		U	I (A)	Temp (C)			
--	Normal	--	--	--	--		
--	Abnormal	--	--	--	--		
--	Single fault –SC/OC	--	--	--	--		
Supplementary Information:							
Battery identification	Charging at $T_{lowest}$ (°C)	Observation	Charging at $T_{highest}$ (°C)	Observation			
--	--	--	--	--			
Supplementary Information:							

Annex Q.1		TABLE: Circuits intended for interconnection with building wiring (LPS)	P
Note: Measured UOC (V) with all load circuits disconnected:			

IEC 62368-1						
Clause	Requirement + Test	Result - Remark			Verdict	
Output Circuit	Components	U <sub>oc</sub> (V)	I <sub>sc</sub> (A)		S (VA)	
			Meas.	Limit	Meas.	Limit
GT-86122-1212						
Output	Normal condition	12.17	1.12	8	13.25	100
Output	Abnormal condition (over load)	12.17	1.12	8	13.25	100
Output	U2 pin 1-8 S-C	--	0 <sup>#</sup>	8	0 <sup>#</sup>	100
Output	R11 S-C	--	0 <sup>#</sup>	8	0 <sup>#</sup>	100
GT-86122-1105.2						
Output	Normal condition	5.20	2.46	8	12.26	100
Output	Abnormal condition (over load)	5.20	2.46	8	12.26	100
Output	U2 pin 1-8 S-C	--	0 <sup>#</sup>	8	0 <sup>#</sup>	100
Output	R11 S-C	--	0 <sup>#</sup>	8	0 <sup>#</sup>	100
Supplementary Information: S-C=Short circuit, O-C=Open circuit # Unit shutdown immediately, F1 damage, no hazard.						

T.2, T.3, T.4, T.5	TABLE: Steady force test					P
Part/Location	Material	Thickness (mm)	Force (N)	Test Duration (sec)	Observation	
Internal components (according to T.2)	--	--	10	5	No hazard.	
No opening (according to T.3)	--	--	--	-	--	
External enclosure top, bottom, sides (according to T.4)	Plastic*	See table 4.1.2	100	5	No hazard.	
External enclosure top, bottom, sides (according to T.5)	Plastic*	See table 4.1.2	250	5	No hazard.	
Supplementary information: -- *See table 4.1.2						

T.6, T.9	TABLE: Impact tests	N/A
----------	---------------------	-----

IEC 62368-1				
Clause	Requirement + Test		Result - Remark	Verdict
Part/Location	Material	Thickness (mm)	Vertical distance (mm)	Observation
--	--	--	--	--
Supplementary information:				

T.7	TABLE: Drop tests				P
Part/Location	Material	Thickness (mm)	Drop Height (mm)	Observation	
Three side of enclosure	Plastics*	1.5	1000mm	After the drop test, enclosure remained intact, no cracking/opening developed in the enclosure joint. Internal ES3, TS3 were not accessible after test. No insulation breakdown.	
Supplementary information: *Test were performed on product with each source listed in table 4.1.2					

T.8	TABLE: Stress relief test					P
Part/Location	Material	Thickness (mm)	Oven Temperature (°C)	Duration (h)	Observation	
Enclosure	Plastics*	1.5mm	108	7	Enclosure remained intact, no cracking/opening developed in the enclosure joint. Internal ES3, TS3 were not accessible after test. No insulation breakdown.	
Supplementary information: *Test were performed on product with each source listed in table 4.1.2						

IEC 62368-1			
Clause	Requirement + Test	Result - Remark	Verdict

Appendix Table:

5.4.1.8	Table: working voltage measurement				P
Location From	to	RMS voltage (V)	Peak voltage (V)	Comments	
T1 Pin 1	Pin 6	202	340	--	
T1 Pin 2	Pin 6	202	388	--	
T1 Pin 4	Pin 6	<b>253</b>	<b>568</b>	The highest RMS & peak working voltage, The working frequency 58.25KHz	
T1 Pin 5	Pin 6	213	360	--	
T1 Pin 1	Pin 7	201	356	--	
T1 Pin 2	Pin 7	201	344	--	
T1 Pin 4	Pin 7	245	552	--	
T1 Pin 5	Pin 7	214	396	--	
CY1 Pri. pin	Sec. pin	210	356	--	
supplementary information:					
Test voltage: 240V					
Test frequency: 60Hz					



IEC 62368-1			
Clause	Requirement + Test	Result - Remark	Verdict

Appendix table	TABLE: transformers (T1)							P
Loc.	Tested insulation	Working voltage peak / V	Working voltage rms / V	Required electric strength	Required clearance / mm	Required creepage distance / mm	Required distance thr. insul.	
Primary winding to secondary winding pins	Reinforced insulation	568	253	4242Vdc	4.5	5.2	0.4mm	
Core to secondary winding pins	Reinforced insulation	568	253	4242Vdc	4.5	5.2	0.4mm	
Loc.	Tested insulation			Test voltage/ V	Measured clearance / mm	Measured creepage dist./ mm	Measured distance thr. insul. / mm; number of layers	
Primary winding to secondary winding pins	Reinforced insulation			4242Vdc	8.0	10.0	TIW	
Core to secondary winding pins	Reinforced insulation			4242Vdc	8.0	8.0	TIW	
Supplementary information: Concentric windings on single bobbin. Outer winding is primary, 2 layers of insulation tape around outer winding. Core considered as primary conductor. Transformer core was isolated from Sec. part by a insulation sheet. More details see photo document.								

-END-

IEC62368_1B - ATTACHMENT			
Clause	Requirement + Test	Result - Remark	Verdict

<b>ATTACHMENT TO TEST REPORT IEC 62368-1</b> <b>EUROPEAN GROUP DIFFERENCES AND NATIONAL DIFFERENCES</b> <b>(Audio/video, information and communication technology equipment Part 1: Safety requirements)</b>	
Differences according to..... :	EN 62368-1:2014+A11:2017
Attachment Form No. .... :	EU_GD_IEC62368_1B_II
Attachment Originator..... :	Nemko AS
Master Attachment..... :	Date 2017-09-22
<b>Copyright © 2017 IEC System for Conformity Testing and Certification of Electrical Equipment (IECEE), Geneva, Switzerland. All rights reserved.</b>	

	<b>CENELEC COMMON MODIFICATIONS (EN)</b>					P
	Clauses, subclauses, notes, tables, figures and annexes which are additional to those in IEC 62368-1:2014 are prefixed "Z".					P
CONTENTS	<b>Add</b> the following annexes: Annex ZA (normative) Normative references to international publications with their corresponding European publications Annex ZB (normative) Special national conditions Annex ZC (informative) A-deviations Annex ZD (informative) IEC and CENELEC code designations for flexible cords					P
	<b>Delete</b> all the "country" notes in the reference document (IEC 62368-1:2014) according to the following list:					P
	0.2.1	Note	1	Note 3	4.1.15	Note
	4.7.3	Note 1 and 2	5.2.2.2	Note	5.4.2.3.2.2 Table 13	Note c
	5.4.2.3.2.4	Note 1 and 3	5.4.2.5	Note 2	5.4.5.1	Note
	5.5.2.1	Note	5.5.6	Note	5.6.4.2.1	Note 2 and 3
	5.7.5	Note	5.7.6.1	Note 1 and 2	10.2.1 Table 39	Note 2, 3 and 4
	10.5.3	Note 2	10.6.2.1	Note 3	F.3.3.6	Note 3
	For special national conditions, see Annex ZB.					P
1	<b>Add</b> the following note: NOTE Z1 The use of certain substances in electrical and electronic equipment is restricted within the EU: see Directive 2011/65/EU.					P

IEC62368_1B - ATTACHMENT			
Clause	Requirement + Test	Result - Remark	Verdict
4.Z1	<p><b>Add</b> the following new subclause after 4.9:</p> <p>To protect against excessive current, short-circuits and earth faults in circuits connected to an a.c. <b>mains</b>, protective devices shall be included either as integral parts of the equipment or as parts of the building installation, subject to the following, a), b) and c):</p> <p>a) except as detailed in b) and c), protective devices necessary to comply with the requirements of B.3.1 and B.4 shall be included as parts of the equipment;</p> <p>b) for components in series with the mains input to the equipment such as the supply cord, appliance coupler, r.f.i. filter and switch, short-circuit and earth fault protection may be provided by protective devices in the building installation;</p> <p>c) it is permitted for <b>pluggable equipment type B</b> or <b>permanently connected equipment</b>, to rely on dedicated overcurrent and short-circuit protection in the building installation, provided that the means of protection, e.g. fuses or circuit breakers, is fully specified in the installation instructions.</p> <p>If reliance is placed on protection in the building installation, the installation instructions shall so state, except that for <b>pluggable equipment type A</b> the building installation shall be regarded as providing protection in accordance with the rating of the wall socket outlet.</p>	<p>Considered.</p> <p>Complied with item a) for internal fuse used and for parts as described in b) reliance on the protection in the building installation.</p>	P
5.4.2.3.2.4	<p><b>Add</b> the following to the end of this subclause:</p> <p>The requirement for interconnection with <b>external circuit</b> is in addition given in EN 50491-3:2009.</p>	No external circuits.	N/A
10.2.1	<p><b>Add</b> the following to c) and d) in table 39:</p> <p>For additional requirements, see 10.5.1.</p>	No such radiation from the equipment.	N/A
10.6.1	<p><b>Add</b> the following paragraph to the end of the subclause:</p> <p>EN 71-1:2011, 4.20 and the related tests methods and measurement distances apply.</p>	No such x-radiation generated from the equipment.	N/A
10.Z1	<p><b>Add</b> the following new subclause after 10.6.5.</p> <p><b>10.Z1 Non-ionizing radiation from radio frequencies in the range 0 to 300 GHz</b></p> <p>The amount of non-ionizing radiation is regulated by European Council Recommendation 1999/519/EC of 12 July 1999 on the limitation of exposure of the general public to electromagnetic</p>	No such consideration for the purpose of personal music players.	N/A

IEC62368_1B - ATTACHMENT			
Clause	Requirement + Test	Result - Remark	Verdict
	fields (0 Hz to 300 GHz). For intentional radiators, ICNIRP guidelines should be taken into account for Limiting Exposure to Time-Varying Electric, Magnetic, and Electromagnetic Fields (up to 300 GHz). For hand-held and body-mounted devices, attention is drawn to EN 50360 and EN 50566		
G.7.1	<b>Add</b> the following note: NOTE Z1 The harmonized code designations corresponding to the IEC cord types are given in Annex ZD.		N/A
Bibliography	<b>Add</b> the following standards: <b>Add</b> the following notes for the standards indicated: IEC 60130-9 NOTE Harmonized as EN 60130-9. IEC 60269-2 NOTE Harmonized as HD 60269-2. IEC 60309-1 NOTE Harmonized as EN 60309-1. IEC 60364 NOTE some parts harmonized in HD 384/HD 60364 series. IEC 60601-2-4 NOTE Harmonized as EN 60601-2-4. IEC 60664-5 NOTE Harmonized as EN 60664-5. IEC 61032:1997 NOTE Harmonized as EN 61032:1998 (not modified). IEC 61508-1 NOTE Harmonized as EN 61508-1. IEC 61558-2-1 NOTE Harmonized as EN 61558-2-1. IEC 61558-2-4 NOTE Harmonized as EN 61558-2-4. IEC 61558-2-6 NOTE Harmonized as EN 61558-2-6. IEC 61643-1 NOTE Harmonized as EN 61643-1. IEC 61643-21 NOTE Harmonized as EN 61643-21. IEC 61643-311 NOTE Harmonized as EN 61643-311. IEC 61643-321 NOTE Harmonized as EN 61643-321. IEC 61643-331 NOTE Harmonized as EN 61643-331.		N/A
<b>ZB</b>	<b>ANNEX ZB, SPECIAL NATIONAL CONDITIONS (EN)</b>		P
4.1.15	<b>Denmark, Finland, Norway and Sweden</b> To the end of the subclause the following is added: <b>Class I pluggable equipment type A</b> intended for connection to other equipment or a network shall, if safety relies on connection to reliable earthing or if surge suppressors are connected between the network terminals and <b>accessible</b> parts, have a marking stating that the equipment shall be connected to an earthed <b>mains</b> socket-outlet. The marking text in the applicable countries shall be as follows:	Class II equipment.	N/A

IEC62368_1B - ATTACHMENT			
Clause	Requirement + Test	Result - Remark	Verdict
	<p>In <b>Denmark</b>: "Apparatets stikprop skal tilsluttes en stikkontakt med jord som giver forbindelse til stikproppens jord."</p> <p>In <b>Finland</b>: "Laite on liitettävä suojakoskettimilla varustettuun pistorasiaan"</p> <p>In <b>Norway</b>: "Apparatet må tilkoples jordet stikkontakt"</p> <p>In <b>Sweden</b>: "Apparaten skall anslutas till jordat uttag"</p>		
4.7.3	<p><b>United Kingdom</b></p> <p>To the end of the subclause the following is added: The torque test is performed using a socket-outlet complying with BS 1363, and the plug part shall be assessed to the relevant clauses of BS 1363. Also see Annex G.4.2 of this annex</p>	Shall be evaluated during national approval	N/A
5.2.2.2	<p><b>Denmark</b></p> <p>After the 2nd paragraph add the following: A warning (marking <b>safeguard</b>) for high <b>touch current</b> is required if the <b>touch current</b> exceeds the limits of 3,5 mA a.c. or 10 mA d.c.</p>	No high touch current.	N/A
5.4.11.1 and Annex G	<p><b>Finland and Sweden</b></p> <p>To the end of the subclause the following is added: For separation of the telecommunication network from earth the following is applicable: If this insulation is solid, including insulation forming part of a component, it shall at least consist of either</p> <ul style="list-style-type: none"> <li>• two layers of thin sheet material, each of which shall pass the electric strength test below, or</li> <li>• one layer having a distance through insulation of at least 0,4 mm, which shall pass the electric strength test below.</li> </ul> <p>If this insulation forms part of a semiconductor component (e.g. an optocoupler), there is no distance through insulation requirement for the insulation consisting of an insulating compound completely filling the casing, so that clearances and creepage distances do not exist, if the component passes the electric strength test in accordance with the compliance clause below and in addition</p> <ul style="list-style-type: none"> <li>• passes the tests and inspection criteria of 5.4.8 with an electric strength test of 1,5 kV multiplied by 1,6 (the electric strength test of 5.4.9 shall be</li> </ul>	No TNV circuits.	N/A

IEC62368_1B - ATTACHMENT			
Clause	Requirement + Test	Result - Remark	Verdict
	<p>performed using 1,5 kV), and</p> <ul style="list-style-type: none"> <li>is subject to routine testing for electric strength during manufacturing, using a test voltage of 1,5kV.</li> </ul> <p>It is permitted to bridge this insulation with a capacitor complying with EN 60384-14:2005, subclass Y2.</p> <p>A capacitor classified Y3 according to EN 60384-14:2005, may bridge this insulation under the following conditions:</p> <ul style="list-style-type: none"> <li>the insulation requirements are satisfied by having a capacitor classified Y3 as defined by EN 60384-14, which in addition to the Y3 testing, is tested with an impulse test of 2,5 kV defined in 5.4.11;</li> <li>the additional testing shall be performed on all the test specimens as described in EN 60384-14; the impulse test of 2,5 kV is to be performed before the endurance test in EN 60384-14, in the sequence of tests as described in EN 60384-14.</li> </ul>		
5.5.2.1	<p><b>Norway</b></p> <p>After the 3rd paragraph the following is added:</p> <p>Due to the IT power system used, capacitors are required to be rated for the applicable line-to-line voltage (230 V).</p>	Shall be evaluated when national approval	N/A
5.5.6	<p><b>Finland, Norway and Sweden</b></p> <p>To the end of the subclause the following is added:</p> <p>Resistors used as <b>basic safeguard</b> or bridging <b>basic insulation in class I pluggable equipment type A</b> shall comply with G.10.1 and the test of G.10.2.</p>	No such resistors.	N/A
5.6.1	<p><b>Denmark</b></p> <p><b>Add</b> to the end of the subclause</p> <p>Due to many existing installations where the socket-outlets can be protected with fuses with higher rating than the rating of the socket-outlets the protection for pluggable equipment type A shall be an integral part of the equipment.</p> <p><i>Justification:</i></p> <p>In Denmark an existing 13 A socket outlet can be protected by a 20 A fuse.</p>	Considered.	P

IEC62368_1B - ATTACHMENT			
Clause	Requirement + Test	Result - Remark	Verdict
5.6.4.2.1	<p><b>Ireland and United Kingdom</b></p> <p>After the indent for <b>pluggable equipment type A</b>, the following is added:</p> <p>– the <b>protective current rating</b> is taken to be 13 A, this being the largest rating of fuse used in the <b>mains</b> plug.</p>	Considered.	P
5.6.5.1	<p>To the second paragraph the following is added:</p> <p>The range of conductor sizes of flexible cords to be accepted by terminals for equipment with a rated current over 10 A and up to and including 13 A is: 1,25 mm<sup>2</sup> to 1,5 mm<sup>2</sup> in cross-sectional area.</p>	See above.	N/A
5.7.5	<p><b>Denmark</b></p> <p>To the end of the subclause the following is added:</p> <p>The installation instruction shall be affixed to the equipment if the <b>protective conductor current</b> exceeds the limits of 3,5 mA a.c. or 10 mA d.c.</p>	No high protective conductor current.	N/A
5.7.6.1	<p><b>Norway and Sweden</b></p> <p>To the end of the subclause the following is added:</p> <p>The screen of the television distribution system is normally not earthed at the entrance of the building and there is normally no equipotential bonding system within the building. Therefore the protective earthing of the building installation needs to be isolated from the screen of a cable distribution system.</p> <p>It is however accepted to provide the insulation external to the equipment by an adapter or an interconnection cable with galvanic isolator, which may be provided by a retailer, for example.</p> <p>The user manual shall then have the following or similar information in Norwegian and Swedish language respectively, depending on in what country the equipment is intended to be used in:</p> <p>“Apparatus connected to the protective earthing of the building installation through the mains connection or through other apparatus with a connection to protective earthing – and to a television distribution system using coaxial cable, may in some circumstances create a fire hazard. Connection to a television distribution system therefore has to be provided through a device providing electrical isolation below a certain frequency range (galvanic isolator, see EN 60728-11)”</p>	Not such system.	N/A

IEC62368_1B - ATTACHMENT			
Clause	Requirement + Test	Result - Remark	Verdict
	<p>NOTE In Norway, due to regulation for CATV-installations, and in Sweden, a galvanic isolator shall provide electrical insulation below 5 MHz. The insulation shall withstand a dielectric strength of 1,5 kV r.m.s., 50 Hz or 60 Hz, for 1 min.</p> <p>Translation to Norwegian (the Swedish text will also be accepted in Norway):                      “Apparater som er koplet til beskyttelsesjord via nettplugg og/eller via annet jordtilkøpelt utstyr – og er tilkøpelt et koaksialbasert kabel-TV nett, kan forårsake brannfare. For å unngå dette skal det ved tilkøpling av apparater til kabel-TV nett installeres en galvanisk isolator mellom apparatet og kabel-TV nettet.”</p> <p>Translation to Swedish:                      ”Apparater som är kopplad till skyddsjord via jordat vägguttag och/eller via annan utrustning och samtidigt är kopplad till kabel-TV nät kan i vissa fall medföra risk för brand. För att undvika detta skall vid anslutning av apparaten till kabel-TV nät galvanisk isolator finnas mellan apparaten och kabel-TV nätet.”.</p>		
5.7.6.2	<p><b>Denmark</b>                      To the end of the subclause the following is added:                      The warning (marking safeguard) for high touch current is required if the touch current or the protective current exceed the limits of 3,5 mA .</p>	No external circuits.	N/A
B.3.1 and B.4	<p><b>Ireland and United Kingdom</b>                      The following is applicable:                      To protect against excessive currents and short-circuits in the primary circuit of <b>direct plug-in equipment</b>, tests according to Annexes B.3.1 and B.4 shall be conducted using an external miniature circuit breaker complying with EN 60898-1, Type B, rated 32A. If the equipment does not pass these tests, suitable protective devices shall be included as an integral part of the <b>direct plug-in equipment</b>, until the requirements of Annexes B.3.1 and B.4 are met</p>	Direct plug-in equipment. Shall be evaluated during national approval	N/A
G.4.2	<p><b>Denmark</b>                      To the end of the subclause the following is added:                      Supply cords of single phase appliances having a rated current not exceeding 13 A shall be provided with a plug according to DS 60884-2-D1:2011.                      CLASS I EQUIPMENT provided with socket-outlets with earth contacts or which are intended to be used in</p>		N/A



IEC62368_1B - ATTACHMENT			
Clause	Requirement + Test	Result - Remark	Verdict
	<p>locations where protection against indirect contact is required according to the wiring rules shall be provided with a plug in accordance with standard sheet DK 2-1a or DK 2-5a.</p> <p>If a single-phase equipment having a RATED CURRENT exceeding 13 A or if a poly-phase equipment is provided with a supply cord with a plug, this plug shall be in accordance with the standard sheets DK 6-1a in DS 60884-2-D1 or EN 60309-2.</p> <p>Mains socket outlets intended for providing power to Class II apparatus with a rated current of 2,5 A shall be in accordance DS 60884-2-D1:2011 standard sheet DKA 1-4a.</p> <p>Other current rating socket outlets shall be in compliance with Standard Sheet DKA 1-3a or DKA 1-1c.</p> <p>Mains socket-outlets with earth shall be in compliance with DS 60884-2-D1:2011 Standard Sheet DK 1-3a, DK 1-1c, DK1-1d, DK 1-5a or DK 1-7a</p> <p><i>Justification:</i> Heavy Current Regulations, Section 6c</p>		
G.4.2	<p><b>United Kingdom</b></p> <p>To the end of the subclause the following is added: The plug part of direct plug-in equipment shall be assessed to BS 1363: Part 1, 12.1, 12.2, 12.3, 12.9, 12.11, 12.12, 12.13, 12.16, and 12.17, except that the test of 12.17 is performed at not less than 125 °C. Where the metal earth pin is replaced by an Insulated Shutter Opening Device (ISOD), the requirements of clauses 22.2 and 23 also apply.</p>	Direct plug-in equipment. Shall be evaluated during national approval	N/A
G.7.1	<p><b>United Kingdom</b></p> <p>To the first paragraph the following is added: Equipment which is fitted with a flexible cable or cord and is designed to be connected to a mains socket conforming to BS 1363 by means of that flexible cable or cord shall be fitted with a 'standard plug' in accordance with the Plugs and Sockets etc (Safety) Regulations 1994, Statutory Instrument 1994 No. 1768, unless exempted by those regulations.</p> <p>NOTE "Standard plug" is defined in SI 1768:1994 and essentially means an approved plug conforming to BS 1363 or an approved conversion plug.</p>		N/A

IEC62368_1B - ATTACHMENT			
Clause	Requirement + Test	Result - Remark	Verdict
G.7.1	<p><b>Ireland</b></p> <p>To the first paragraph the following is added: Apparatus which is fitted with a flexible cable or cord shall be provided with a plug in accordance with Statutory Instrument 525: 1997, "13 A Plugs and Conversion Adapters for Domestic Use Regulations: 1997. S.I. 525 provides for the recognition of a standard of another Member State which is equivalent to the relevant Irish Standard</p>		N/A
G.7.2	<p><b>Ireland and United Kingdom</b></p> <p>To the first paragraph the following is added: A power supply cord with a conductor of 1,25 mm<sup>2</sup> is allowed for equipment which is rated over 10 A and up to and including 13 A.</p>		N/A
<b>ZC</b>	<b>ANNEX ZC, NATIONAL DEVIATIONS (EN)</b>		
10.5.2	<p><b>Germany</b></p> <p>The following requirement applies: For the operation of any cathode ray tube intended for the display of visual images operating at an acceleration voltage exceeding 40 kV, authorization is required, or application of type approval (Bauartzulassung) and marking. <i>Justification:</i> German ministerial decree against ionizing radiation (Röntgenverordnung), in force since 2002-07-01, implementing the European Directive 96/29/EURATOM. <b>NOTE</b> Contact address: Physikalisch-Technische Bundesanstalt, Bundesallee 100, D-38116 Braunschweig, Tel.: Int+49-531-592-6320, Internet: <a href="http://www.ptb.de">http://www.ptb.de</a></p>	No CRT within the equipment.	N/A

IEC62368_1B - ATTACHMENT			
Clause	Requirement + Test	Result - Remark	Verdict

<p><b>ATTACHMENT TO TEST REPORT IEC 62368-1</b>  <b>DENMARK NATIONAL DIFFERENCES</b>                  Audio/video, information and communication technology equipment –                  Part 1: Safety requirements</p>
<p><b>Differences according to</b>..... : DS/EN 62368-1:2014</p>
<p><b>Attachment Form No.</b> .... : DK_ND_IEC62368_1B</p>
<p><b>Attachment Originator</b>..... : UL (Demko)</p>
<p><b>Master Attachment</b>..... : 2014-10</p>
<p><b>Copyright © 2014 IEC System for Conformity Testing and Certification of Electrical Equipment (IECEE), Geneva, Switzerland. All rights reserved.</b></p>

	National Differences		
4.1.15	<p>To the end of the subclause the following is added:</p> <p>Class I pluggable equipment type A intended for connection to other equipment or a network shall, if safety relies on connection to reliable earthing or if surge suppressors are connected between the network terminals and accessible parts, have a marking stating that the equipment shall be connected to an earthed mains socket-outlet.</p> <p>The marking text in the applicable countries shall be as follows:</p> <p>“Apparatets stikprop skal tilsluttes en stikkontakt med jord som giver forbindelse til stikproppens jord.”</p>		N/A
5.2.2.2	<p>After the 2nd paragraph add the following:</p> <p>A warning (marking safeguard) for high touch current is required if the touch current exceeds the limits of 3,5 mA a.c. or 10 mA d.c.</p>		N/A
5.6.1	<p>Add to the end of the subclause:</p> <p>Due to many existing installations where the socket-outlets can be protected with fuses with higher rating than the rating of the socket-outlets the protection for pluggable equipment type A shall be an integral part of the equipment.</p> <p>Justification:</p> <p>In Denmark an existing 13 A socket outlet can be protected by a 20 A fuse.</p>		N/A

IEC62368_1B - ATTACHMENT			
Clause	Requirement + Test	Result - Remark	Verdict
5.7.5	To the end of the subclause the following is added: The installation instruction shall be affixed to the equipment if the protective conductor current exceeds the limits of 3,5 mA a.c. or 10 mA d.c.		N/A
5.7.6.2	To the end of the subclause the following is added: The warning (marking safeguard) for high touch current is required if the touch current or the protective current exceed the limits of 3,5 mA.		N/A
G.4.2	To the end of the subclause the following is added: Supply cords of single phase appliances having a rated current not exceeding 13 A shall be provided with a plug according to DS 60884-2-D1:2011. CLASS I EQUIPMENT provided with socket-outlets with earth contacts or which are intended to be used in locations where protection against indirect contact is required according to the wiring rules shall be provided with a plug in accordance with standard sheet DK 2-1a or DK 2-5a. If a single-phase equipment having a RATED CURRENT exceeding 13 A or if a poly-phase equipment is provided with a supply cord with a plug, this plug shall be in accordance with the standard sheets DK 6-1a in DS 60884-2-D1 or EN 60309-2. Mains socket outlets intended for providing power to Class II apparatus with a rated current of 2,5 A shall be in accordance DS 60884-2-D1:2011 standard sheet DKA 1-4a. Other current rating socket outlets shall be in compliance with Standard Sheet DKA 1-3a or DKA 1-1c. Mains socket-outlets with earth shall be in compliance with DS 60884-2-D1:2011 Standard Sheet DK 1-3a, DK 1-1c, DK1-1d, DK 1-5a or DK 1-7a Justification: Heavy Current Regulations, Section 6c		N/A



IEC62368_1B - ATTACHMENT			
Clause	Requirement + Test	Result - Remark	Verdict

<b>ATTACHMENT TO TEST REPORT IEC 62368-1 2<sup>th</sup> Ed.</b> <b>U.S.A NATIONAL DIFFERENCES</b> Audio/video, information and communication technology equipment – Part 1: Safety requirements	
Differences according to..... :	CSA/UL 62368-1:2014
Attachment Form No. .... :	US&CA_ND_IEC623681B
Attachment Originator..... :	UL(US)
Master Attachment..... :	Date 2015-06
<b>Copyright © 2015 IEC System for Conformity Testing and Certification of Electrical Equipment (IECEE), Geneva, Switzerland. All rights reserved.</b>	

<b>IEC 62368-1 - US and Canadian National Differences</b> <b>Special National Conditions based on Regulations and Other National Differences</b>			
1.1	All equipment is to be designed to allow installation according to the National Electrical Code (NEC), ANSI/NFPA 70, the Canadian Electrical Code (CEC), Part I, CAN/CSA C22.1, and when applicable, the National Electrical Safety Code, IEEE C2. Also, for such equipment marked or otherwise identified, installation is allowed per the Standard for the Protection of Information Technology Equipment, ANSI/NFPA 75.	In accordance with the National Electrical Code (NEC) and the Canadian Electrical Code (CEC) part 1 CAN/CSA C22.1, ANSI/NFPA 70, and unless marked or otherwise identified, the Standard for Electronic Computer/Data-Processing Equipment, ANSI/NFPA 75.	P
1.4	Additional requirements apply to some forms of power distribution equipment, including sub-assemblies.	Considered.	P
4.1.17	For lengths exceeding 3.05 m, external interconnecting flexible cord and cable assemblies are required to be a suitable cable type (e.g., DP, CL2) specified in the NEC.		N/A
	For lengths 3.05 m or less, external interconnecting flexible cord and cable assemblies that are not types specified in the NEC generally are required to have special construction features and identification markings.	See above.	N/A
4.8	Lithium coin / button cell batteries have modified special construction and performance requirements.	No such batteries.	N/A

IEC62368_1B - ATTACHMENT			
Clause	Requirement + Test	Result - Remark	Verdict
5.6.3	Protective earthing conductors comply with the minimum conductor sizes in Table G.5, except as required by Table G.7ADV.1 for cord connected equipment, or Annex DVH for permanently connected equipment	Direct plug-in type, Class II	N/A
5.7.7	Equipment intended to receive telecommunication ringing signals complies with a special touch current measurement tests.	No TNV circuits within the equipment.	N/A
6.5.1	PS3 wiring outside a fire enclosure complies with single fault testing in B.4, or be current limited per one of the permitted methods.	No such parts.	N/A
Annex F (F.3.3.8)	Output terminals provided for supply of other equipment, except mains, supply are marked with a maximum rating or references to which equipment it is permitted to be connected.	DC output connector is provided. Indicated by User specification.	P
Annex G (G.7.1)	Permanent connection of equipment to the mains supply by a power supply cord is not permitted, except for certain equipment, such as ATMs.	The equipment is not permanent connection equipment.	N/A
Annex G (G.7.3)	Power supply cords are required to have attachment plugs rated not less than 125 percent of the rated current of the equipment.		N/A
	Flexible power supply cords are required to be compatible with Article 400 of the NEC, and Tables 11 and 12 of the CEC.	See above.	N/A
Annex G (G.7.5)	Minimum cord length is required to be 1.5 m, with certain constructions such as external power supplies allowed to consider both input and output cord lengths into the requirement. Power supply cords are required to be no longer than 4.5 m in length if used in ITE Rooms.	See above.	N/A
Annex H.2	Continuous ringing signals under normal operating conditions up to 16 mA only are permitted if the equipment is subjected to special installation and performance restrictions.	No TNV circuits within the equipment.	N/A
Annex H.4	For circuits with other than ringing signals and with voltages exceeding 42.4 V <sub>peak</sub> or 60 V d.c., the maximum acceptable current through a 2000 ohm resistor (or greater) connected across the voltage source with other loads disconnected is 7.1 mA peak or 30 mA d.c. under normal operating conditions.	No TNV circuits within the equipment.	N/A
Annex M	Battery packs for stationary applications comply with special component requirements.	No such parts.	N/A

IEC62368_1B - ATTACHMENT			
Clause	Requirement + Test	Result - Remark	Verdict
Annex DVA (1)	Equipment intended for use in spaces used for environmental air are subjected to special flammability requirements for heat and visible smoke release.	The equipment not intended to be used within such environments.	N/A
	For ITE room applications, automated information storage systems with combustible media greater than 0.76 m <sup>3</sup> (27 cu ft) have a provision for connection of either automatic sprinklers or a gaseous agent extinguishing system with an extended discharge.	Not such equipment.	N/A
	Consumer products designed or intended primarily for children 12 years of age or younger are subject to additional requirements in accordance with U.S. & Canadian Regulations.	The equipment is not for children used.	N/A
	Baby monitors additionally comply with ASTM F2951, Consumer Safety Specification for Baby Monitors.	Not a baby monitors.	N/A
Annex DVA (5.6.3)	For Pluggable Equipment Type A, the protection in the installation is assumed to be 20A.	Considered.	P
Annex DVA (6.3)	The maximum quantity of flammable liquid stored in equipment complies with NFPA 30.	No flammable liquids within the equipment.	N/A
Annex DVA (6.4.8)	For ITE room applications, enclosures with combustible material measuring greater than 0.9 m <sup>2</sup> (10 sq ft) or a single dimension greater than 1.8 m (6 ft) have a flame spread rating of 50 or less. For equipment with the same dimensions for other applications, an external surface that is not a fire enclosure requires a min. flammability classification of V-1.	No such application.	N/A
Annex DVA (10.3.1)	Equipment with lasers meets the U.S. Code of Federal Regulations 21 CFR 1040 (and the Canadian Radiation Emitting Devices Act, REDR C1370).	No such parts.	N/A
Annex DVA (10.5.1)	Equipment that produces ionizing radiation complies with the U.S. Code of Federal Regulations, 21 CFR 1020 (and the Canadian Radiation Emitting Devices Act, REDR C1370).	No such parts.	N/A

IEC62368_1B - ATTACHMENT			
Clause	Requirement + Test	Result - Remark	Verdict
Annex DVA (F.3.3.3)	Equipment for use on a.c. mains supply systems with a neutral and more than one phase conductor (e.g. 120/240 V, 3-wire) require a special marking format for electrical ratings. Additional considerations apply for voltage ratings that exceed the attachment cap rating or are lower than the "Normal Operating Condition" in Table 2 of CAN/CSA C22.2 No. 235."	Single phase only.	N/A
Annex DVA (F.3.3.5)	Equipment identified for ITE (computer) room installation is marked with the rated current	Not such application.	N/A
Annex DVA (G.1)	Vertically-mounted disconnect switches and circuit breakers have the "on" position indicated by the handle in the up position	No such parts.	N/A
Annex DVA (G.3.4)	Suitable NEC/CEC branch circuit protection rated at the maximum circuit rating is required for all standard supply outlets and receptacles (such as supplied in power distribution units) if the supply branch circuit protection is not suitable.	No standard supply outlets, receptacles, medium-base or smaller lampholders provided.	N/A
Annex DVA (G.4.2)	Equipment with isolated ground (earthing) receptacles complies with NEC 250.146(D) and CEC 10-112 and 10-906(8).	No such parts.	N/A
Annex DVA (G.4.3)	Where a fuse is used to provide Class 2 or Class 3 current limiting, it is not operator-accessible unless it is non- interchangeable.	No such parts.	N/A
Annex DVA (G.5.3)	Power distribution transformers distributing power at 100 volts or more, and rated 10 kVA or more, require special transformer overcurrent protection.	No such parts.	N/A
Annex DVA (G.5.4)	Motor control devices are required for cord-connected equipment with a mains-connected motor if the equipment is rated more than 12 A, or if the equipment has a nominal voltage rating greater than 120 V, or if the motor is rated more than 1/3 hp (locked rotor current over 43 A).	No such parts.	N/A
Annex DVA (Annex M)	For ITE room applications, equipment with battery systems capable of supplying 750 VA for five minutes have a battery disconnect means that may be connected to the ITE room remote power-off circuit.	Not such application.	N/A
Annex DVA (Q)	Wiring terminals intended to supply Class 2 outputs according to the NEC or CEC Part 1 are marked with the voltage rating and "Class 2" or equivalent; marking is located adjacent to the terminals and visible during wiring.	Not applicable for the equipment.	N/A



IEC62368_1B - ATTACHMENT			
Clause	Requirement + Test	Result - Remark	Verdict
Annex DVB (1)	Additional requirements apply for equipment used for entertainment purposes intended for installation in general patient care areas of health care facilities.	Not such application.	N/A
Annex DVC (1)	Additional requirements apply for equipment intended for mounting under kitchen cabinets.	Not such application.	N/A
Annex DVE (4.1.1)	Some equipment, components, sub-assemblies and materials associated with the risk of fire, electric shock, or personal injury have component or material ratings in accordance with the applicable national (U.S. and Canadian) component or material requirements. Components required to comply include: appliance couplers, attachment plugs, battery back-up systems, battery packs, circuit breakers, communication circuit accessories, connectors (used for current interruption of non-LPS circuits), power supply cords, direct plug-in equipment, electrochemical capacitor modules (energy storage modules with ultra-capacitors), enclosures (outdoor), flexible cords and cables, fuses (branch circuit), ground-fault current interrupters, interconnecting cables, data storage equipment, printed wiring, protectors for communications circuits, receptacles, surge protective devices, vehicle battery adapters, wire connectors, and wire and cables.	UL approved components used. Refer to table 4.1.2 of IEC 62368-1 test report for details.	P
Annex DVH	Equipment for permanent connection to the mains supply is subjected to additional requirements.	The equipment is not permanently connected equipment.	N/A
Annex DVH (DVH.1)	Wiring methods (terminals, leads, etc.) used for the connection of the equipment to the mains are in accordance with the NEC/CEC.	Pluggable equipment type A.	N/A
Annex DVH (DVH.3.2)	Terminals for permanent wiring, including protective earthing terminals, are suitable for U.S./Canadian wire gauge sizes, rated 125 percent of the equipment rating, and are specially marked when specified.	No terminals for permanent wiring.	N/A
Annex DVH (DVH.3.2)	Wire binding screws are not permitted to attach conductors larger than 10 AWG (5.3 mm <sup>2</sup> ).	No wire binding screws.	N/A
Annex DVH (DVH.4)	Permanently connected equipment is required to have a suitable wiring compartment and wire bending space.	The equipment is not permanently connected equipment.	N/A

IEC62368_1B - ATTACHMENT			
Clause	Requirement + Test	Result - Remark	Verdict
Annex DVH (DVH 5.5)	Equipment connected to a centralized d.c. power system, and having one pole of the DC mains input terminal connected to the main protective earthing terminal in the equipment, complies with special earthing, wiring, marking and installation instruction requirements.	The equipment not connected to a centralized d.c. power system.	N/A
Annex DVI (6.7 )	Equipment intended for connection to telecommunication network outside plant cable is required to be protected against overvoltage from power line crosses.	No TNV circuits within the equipment.	N/A
Annex DVJ (10.6.1 )	Equipment connected to a telecommunication and cable distribution networks and supplied with an earphone intended to be held against, or in the ear is required to comply with special acoustic pressure requirements.	No TNV circuits within the equipment.	N/A



IEC62368_1B - ATTACHMENT			
Clause	Requirement + Test	Result - Remark	Verdict

<b>ATTACHMENT TO TEST REPORT</b> IEC 62368-1 (AUSTRALIA / NEW ZEALAND) NATIONAL DIFFERENCES (Audio/video, information and communication technology equipment)			
<b>Differences according to</b> .....: AS/NZS 62368.1:2018			
<b>Attachment Form No.</b> .....: AU_NZ_ND_IEC62368_1B			
<b>Attachment Originator</b> .....: JAS-ANZ			
<b>Master Attachment</b> .....: 2019-02-04			
<b>Copyright © 2019 IEC System for Conformity Testing and Certification of Electrical Equipment (IECEE), Geneva, Switzerland. All rights reserved.</b>			
	<b>National Differences</b>		
<b>Appendix ZZ</b>	Variations to IEC 62368-1:2014 (ED. 2.0) for Australia and New Zealand		P
<b>ZZ1 Scope</b>	This Appendix lists the normative variations to IEC 62368-1:2014 (ED. 2.0)		P
<b>ZZ2 Variations</b>	The following modifications are required for Australian/New Zealand conditions:		P
<b>2</b>	Add the following to the list of normative references: The following normative documents are referenced in Appendix ZZ: -AS/NZS 3112, <i>Approval and test specification—Plugs and socket-outlets</i> -AS/NZS 3123, <i>Approval and test specification—Plugs, socket-outlets and couplers for general industrial application</i> -AS/NZS 3191, <i>Electric flexible cords</i> -AS/NZS 60065, <i>Audio, video and similar electronic apparatus—Safety requirements (IEC 60065:2015 (ED.8.0) MOD)</i> -AS/NZS 60320.1, <i>Appliance couplers for household and similar general purposes, Part 1: General requirements (IEC 60320-1, Ed.2.1 (2007) MOD)</i> -AS/NZS 60320.2.2, <i>Appliance couplers for household and similar general purposes Part 2.2: Interconnection couplers for household and similar equipment (IEC 60320-2-2, Ed.2.0 (1998) MOD)</i>		P

IEC62368_1B - ATTACHMENT			
Clause	Requirement + Test	Result - Remark	Verdict
	<p>-AS/NZS 60695.2.11, <i>Fire hazard testing, Part 2.11: Glowing/hot wire based test methods—Glow-wire flammability test method for end-products</i></p> <p>-AS/NZS 60695.11.5, <i>Fire hazard testing, Part 11.5: Test flames—Needle-flame test method—Apparatus, confirmatory test arrangement and guidance</i></p> <p>-AS/NZS 60695.11.10, <i>Fire hazard testing, Part 11.10: Test flames—50 W horizontal and vertical flame test methods</i></p> <p>-AS/NZS 60884.1, <i>Plugs and socket-outlets for household and similar purposes, Part 1: General requirements</i></p> <p>-AS/NZS 60950.1:2015, <i>Information technology equipment—Safety, Part 1: General requirements (IEC 60950-1, Ed.2.2 (2013), MOD)</i></p> <p>IEC 61032:1997, <i>Protection of persons and equipment by enclosures—Probes for verification</i></p> <p>-AS/NZS 61558.1:2008 (including Amendment 2:2015), <i>Safety of Power Transformers, Power Supplies, Reactors and Similar Products, Part 1: General requirements and tests (IEC 61558-1 Ed 2.1, MOD)</i></p> <p>-AS/NZS 61558.2.16, <i>Safety of transformers, reactors, power supply units and similar products for voltages up to 1 100 V, Part 2.16: Particular requirements and tests for switch mode power supply units and transformers for switch mode power supply units.</i></p>		
4.1.1	<p><b>Application of requirements and acceptance of materials, components and subassemblies</b></p> <p>1 <i>Replace the text 'IEC 60950-1' with 'AS/NZS 60950.1:2015'.</i></p> <p>2 <i>Replace the text 'IEC 60065' with 'AS/NZS 60065'.</i></p>		P

IEC62368_1B - ATTACHMENT			
Clause	Requirement + Test	Result - Remark	Verdict
<b>4.7</b>	<b>Equipment for direct insertion into mains socket-outlets</b>		N/A
<b>4.7.2</b>	<p><b>Requirements</b> <i>Delete</i> the text of the second paragraph and <i>replace</i> with the following: Equipment with a plug portion, suitable for insertion into a 10 A 3-pin flat-pin socket-outlet complying with AS/NZS 3112 shall comply with the requirements in AS/NZS 3112 for equipment with integral pins for insertion into socket-outlets.</p>	Direct plug-in equipment. Shall be evaluated during national approval	N/A
<b>4.7.3</b>	<p><b>Compliance Criteria</b> <i>Delete</i> the first paragraph and Note 1 and Note 2 and <i>replace</i> with the following: <i>Compliance is checked by inspection and, if necessary, by the tests in AS/NZS 3112.</i></p>	Direct plug-in equipment. Shall be evaluated during national approval	N/A
<b>4.8</b>	<i>Delete</i> existing clause title and <i>replace</i> with the following: <b>4.8 Products containing coin/button cell batteries</b>		N/A
<b>4.8.1</b>	<p><b>General</b> 1 Second dashed point, <i>delete</i> the text and <i>replace</i> with the following: – include coin/button cell batteries with a diameter of 32 mm or less. 2 After the second dashed point, <i>insert</i> the following Note: NOTE 1: Batteries are specified in IEC 60086-2. 3 After the third dashed point, <i>renumber</i> the existing Note as 'NOTE 2'. 4 Fifth dashed point, <i>delete</i> the word 'lithium'.</p>		N/A
<b>4.8.2</b>	<p><b>Instructional Safeguard</b> First line, <i>delete</i> the word 'lithium'.</p>		N/A
<b>4.8.3</b>	<p><b>Construction</b> First line, after the word 'Equipment' <i>insert</i> the words 'containing one or more coin/button batteries and'</p>		N/A

IEC62368_1B - ATTACHMENT				
Clause	Requirement + Test	Result - Remark		Verdict
<b>4.8.5</b>	<b>Compliance criteria</b> <i>Delete the first paragraph and replace with the following: Compliance is checked by applying a force of 30 N +/-1 N for 10 s to the battery compartment door/cover by a rigid test finger according to test probe 11 of IEC 61032:1997 at the most unfavourable place and in the most unfavourable direction. The force shall be applied in one direction at a time.</i>			N/A
<b>5.4.10.2</b>	<b>Test methods</b>			N/A
<b>5.4.10.2.1</b>	<b>General</b> <i>Delete the first paragraph and replace with the following: In Australia only, the separation is checked by the test of both Clause 5.4.10.2.2 and Clause 5.4.10.2.3. In New Zealand, the separation is checked by the test of either Clause 5.4.10.2.2 or Clause 5.4.10.2.3.</i>			N/A
<b>Table 29</b>	<i>Replace the table with the following:</i>			N/A
Parts	Impulse test		Steady state test	
	New Zealand	Australia	New Zealand	Australia
Parts indicated in Clause 5.4.10.1 a) <sup>a</sup>	2.5 kV 10/700 µs	7.0 kV for hand-held telephones and headsets, 2.5 kV for other equipment. 10/700 µs	1.5 kV	3 kV
Parts indicated in Clause 5.4.10.1 b) and c) <sup>b</sup>	1.5 kV 10/700 µs <sup>c</sup>		1.0 kV	1.5 kV
<sup>a</sup> Surge suppressors shall not be removed. <sup>b</sup> Surge suppressors may be removed, provided that such devices pass the impulse test of Clause 5.4.10.2.2 when tested as components outside the equipment. <sup>c</sup> During this test, it is allowed for a surge suppressor to operate and for a sparkover to occur in a GDT.				

IEC62368_1B - ATTACHMENT			
Clause	Requirement + Test	Result - Remark	Verdict
5.4.10.2.2	After the first paragraph, <i>insert</i> new Notes 201 and 202 as follows: NOTE 201 For Australia, the 7 kV impulse simulates lightning surges on typical rural and semi-rural network lines. NOTE 202 For Australia, the value of 2.5 kV for Clause 5.4.10.1 a) was chosen to ensure the adequacy of the insulation concerned and does not necessarily simulate likely overvoltages.		N/A
5.4.10.2.3	After the first paragraph, <i>insert</i> new Notes 201 and 202 as follows: NOTE 201 For Australia, where there are capacitors across the insulation under test, it is recommended that d.c. test voltages are used. NOTE 202 The 3 kV and 1.5 kV values for Australia have been determined considering the low frequency induced voltages from the power supply distribution system.		N/A
6	<b>Electrically-caused fire</b>		P
6.1	<b>General</b> After the first paragraph, <i>insert</i> the following new paragraph: Alternatively, the requirements of Clauses 6.2 to 6.5.2 are considered to be fulfilled if the equipment complies with the requirements of Clause 6.202		P
6.6	After Clause 6.6, <i>add</i> the new Clauses 6.201 and 6.202 as follows: <b>6.201 External power supplies, docking stations and other similar devices</b> and <b>6.202 Resistance to fire—Alternative tests</b> (see special national conditions)		P
8.5.4	<b>Special categories of equipment comprising moving parts</b>		N/A
8.5.4.1	<b>Large data storage equipment</b> In the first dashed row and the second dashed rows <i>replace</i> 'IEC 60950-1:2005' with 'AS/NZS 60950.1:2015'.		N/A
8.6	<b>Stability of equipment</b>		N/A

IEC62368_1B - ATTACHMENT			
Clause	Requirement + Test	Result - Remark	Verdict
<b>8.6.1 and Table 36</b>	<p><b>Requirements</b></p> <p>1. Table 36, <i>insert</i> Footnote c at the end of the 'Glass slide' heading, and <i>add</i> a new Footnote c after the text of Footnote b in the last row of Table 36 as follows:  <sup>c</sup> The glass slide test is not applicable to floor standing equipment, even though the equipment may have controls or a display.</p> <p>2. Table 36, fifth row, <i>insert</i> <sup>201</sup> at the end of 'No stability requirements'</p> <p>3. Table 36, ninth row, <i>insert</i> <sup>201</sup> at the end of 'No stability requirements'</p> <p>4. Table 36, <i>add</i> the following new footnote:  <sup>201</sup> MS2 and MS3 television sets and display devices, designed only for fixing to a wall, ceiling or equipment track, are not subjected to stability requirements only if the instructional safeguard of Clause 8.6.1.201 is provided. Otherwise, the glass slide requirements of Clause 8.6.4 and horizontal force requirements of Clause 8.6.5 apply.</p> <p>5. Second paragraph beneath Table 36, <i>delete</i> the words 'MS2 and MS3 television sets' and <i>replace</i> with 'MS2 and MS3 television sets and display devices'</p>		N/A
<b>8.6.1</b>	<p>After Clause 8.6.1 <i>add</i> the following new clauses:  <b>8.6.1.201 Instructional safeguard for fixed-mount television sets</b>                      (see special national conditions)</p>		N/A
<b>Annex F Paragraph F.3.5.1</b>	<p><b>Mains appliance outlet and socket-outlet markings</b>  <i>Replace</i> 'IEC 60320-2-2' with 'AS/NZS 60320.2.2'.</p>		N/A
<b>Annex G Paragraph G.4.2</b>	<p><b>Mains connectors</b></p> <p>1 In the second line <i>insert</i> 'or AS/NZS 3123' after 'IEC 60906-1'.</p> <p>2 In the second line <i>insert</i> 'or AS/NZS 60320 series' after 'IEC 60320 series'</p> <p>3 <i>Add</i> the following new paragraph:                      10 A or 15 A 250 V flat pin plugs for the connection of equipment to mains-powered socket-outlets for household or similar general use shall comply with AS/NZS 3112 or AS/NZS 60884.1.</p>		N/A



IEC62368_1B - ATTACHMENT			
Clause	Requirement + Test	Result - Remark	Verdict
<b>Paragraph G.5.3.1</b>	<b>Transformers, General</b> 1 In the third dashed point <i>replace</i> 'IEC 61558-1 and the relevant parts of IEC 61558-2' with 'AS/NZS 61558-1 and the relevant parts of AS/NZS 61558.2' 2 In the fourth dashed point <i>replace</i> 'IEC 61558-2-16' with 'AS/NZS 61558.2.16'.		N/A
<b>Paragraph G.7.1</b>	<b>Mains supply cords, General</b> In the fourth dashed paragraph, <i>replace</i> 'IEC 60320-1' with 'AS/NZS 60320.1'		N/A
<b>Table G.5</b>	<b>Sizes of conductors</b> 1 In the second row, first column, <i>delete</i> '6' and <i>replace</i> with '7.5' 2 In the second row, second column, <i>delete</i> '0,75' and <i>replace</i> with '0.75 <sup>b</sup> 3 <i>Delete</i> Note 1. 4 <i>Replace</i> 'NOTE 2' with 'NOTE:'. 5 <i>Delete</i> the text of 'Footnote b' and <i>replace</i> with the following: <sup>b</sup> This nominal cross-sectional area is only allowed for Class II appliances if the length of the power supply cord, measured between the point where the cord, or cord guard, enters the appliance, and the entry to the plug does not exceed 2 m (0.5 mm <sup>2</sup> three-core supply flexible cords are not permitted; see AS/NZS 3191). 6 In Footnote c <i>replace</i> 'IEC 60320-1' with 'AS/NZS 60320.1' 7 In Footnote d <i>replace</i> 'IEC 60320-1' with 'AS/NZS 60320.1'		N/A
<b>Annex M Paragraph M.3.2</b>	<b>Protection circuits for batteries provided within the equipment, Test method</b> After the first dashed point <i>add</i> the following Note: NOTE 201: In cases where the voltage source is provided by power from an unassociated power source, consideration should be given to the effects of possible single fault conditions in the unassociated equipment. If the power source is unknown then it should be assumed that the maximum limit of SELV may be applied to the source input under assumed single fault conditions in the source when assessing the charging circuit in the equipment under test.		N/A

IEC62368_1B - ATTACHMENT			
Clause	Requirement + Test	Result - Remark	Verdict
	<b>Special national conditions (if any)</b>		N/A
<b>6.201</b>	<p><b>External power supplies, docking stations and other similar devices</b></p> <p>For external power supplies, docking stations and other similar devices, during and after abnormal operating conditions and during single fault conditions the output voltage—</p> <ul style="list-style-type: none"> <li>– at all ES1 outlets or connectors shall not increase by more than 10% of its rated output voltage under normal operating condition; and</li> <li>– of a USB outlet or connector shall not increase by more than 3 V or 10% of its rated output voltage under normal operating conditions, whichever is higher.</li> </ul> <p>For equipment with multiple rated output voltages, the requirements apply with the equipment configured for each rated output voltage in turn.</p> <p>NOTE: This is intended to reduce the possibility of battery fire or explosion in attached equipment or accessories when charging secondary lithium batteries.</p> <p><i>Compliance shall be checked by measurement, taking into account the abnormal operating conditions of Annex B.3 and the simulated single-fault conditions of Annex B.4</i></p>		P
<b>6.202</b>	<b>Resistance to fire—Alternative tests</b>	UL recognized material	P
<b>6.202.1</b>	<p><b>General</b></p> <p>Parts of non-metallic material shall be resistant to ignition and spread of fire.</p> <p>This requirement does not apply to decorative trims, knobs and other parts unlikely to be ignited or to propagate flames from inside the equipment, or the following:</p> <ul style="list-style-type: none"> <li>a) Components that are contained in an enclosure having a flammability category of V-0 according to AS/NZS 60695.11.10 and having openings only for the connecting wires filling the openings completely, and for ventilation not exceeding 1 mm in width regardless of length.</li> <li>b) The following parts which would contribute negligible fuel to a fire:</li> </ul>		N/A

IEC62368_1B - ATTACHMENT			
Clause	Requirement + Test	Result - Remark	Verdict
	<p>– small mechanical parts, the mass of which does not exceed 4 g, such as mounting parts, gears, cams, belts and bearings;</p> <p>– small electrical components, such as capacitors with a volume not exceeding 1 750 mm<sup>3</sup>, integrated circuits, transistors and optocoupler packages, if these components are mounted on material of flammability category V-1, or better, according to AS/NZS 60695.11.10.</p> <p>NOTE: In considering how to minimize propagation of fire and what 'small parts' are, account should be taken of the cumulative effect of small parts adjacent to each other for the possible effect of propagating the fire from one part to another.</p>		
	<p><i>Compliance shall be checked by the tests of Clauses 6.202.2, 6.202.3 and 6.202.4.</i></p> <p>For the base material of printed boards, compliance shall be checked by the test of Clause 6.202.5.</p> <p>The tests shall be carried out on parts of non-metallic material which have been removed from the equipment. When the glow-wire test is carried out, the parts shall be placed in the same orientation as they would be in normal use.</p> <p>These tests are not carried out on internal wiring.</p>		N/A
6.202.2	<p><b>Testing of non-metallic materials</b></p> <p>Parts of non-metallic material shall be subject to the glow-wire test of AS/NZS 60695.2.11 which shall be carried out at 550°C.</p> <p>Parts for which the glow-wire test cannot be carried out, such as those made of soft or foamy material, shall meet the requirements specified in ISO 9772 for category FH-3 material. The glow-wire test shall be not carried out on parts of material classified at least FH-3 according to ISO 9772 provided that the relevant part is not thinner than the sample tested.</p>		N/A
6.202.3	<p><b>Testing of insulating materials</b></p> <p>Parts of insulating material supporting Potential Ignition Sources shall be subject to the glow-wire test of AS/NZS 60695.2.11 which shall be carried out at 750°C.</p> <p>The test shall be also carried out on other parts of insulating material which are within a distance of 3 mm of the connection.</p> <p>NOTE: Contacts in components such as switch contacts are considered to be connections</p>		N/A

IEC62368_1B - ATTACHMENT											
Clause	Requirement + Test	Result - Remark	Verdict								
	<p>For parts which withstand the glow-wire test but produce a flame, other parts above the connection within the envelope of a vertical cylinder having a diameter of 20 mm and a height of 50 mm shall be subjected to the needle-flame test.</p> <p>However, parts shielded by a barrier which meets the needle-flame test need not be tested</p>		N/A								
	<p>The needle-flame test shall be made in accordance with AS/NZS 60695.11.5 with the following modifications:</p> <table border="1"> <tr> <td><b>Clause of AS/NZS 60695.11.5</b></td> <td>Change</td> </tr> <tr> <td><b>9 Test procedure</b></td> <td></td> </tr> <tr> <td><b>9.2 Application of needle-flame</b></td> <td> <p><i>Delete</i> the first and second paragraphs and <i>replace</i> with the following:</p> <p>The specimen shall be arranged so that the flame can be applied to a vertical or horizontal edge as shown in the examples of Figure 1. If possible the flame shall be applied at least 10 mm from a corner.</p> <p>The duration of application of the test flame shall be 30 s ± 1 s.</p> </td> </tr> <tr> <td><b>9.3 Number of test specimens</b></td> <td> <p><i>Replace</i> with the following:</p> <p>The test shall be made on one specimen. If the specimen does not withstand the test, the test may be repeated on two further specimens, both of which shall withstand the test.</p> </td> </tr> </table>	<b>Clause of AS/NZS 60695.11.5</b>	Change	<b>9 Test procedure</b>		<b>9.2 Application of needle-flame</b>	<p><i>Delete</i> the first and second paragraphs and <i>replace</i> with the following:</p> <p>The specimen shall be arranged so that the flame can be applied to a vertical or horizontal edge as shown in the examples of Figure 1. If possible the flame shall be applied at least 10 mm from a corner.</p> <p>The duration of application of the test flame shall be 30 s ± 1 s.</p>	<b>9.3 Number of test specimens</b>	<p><i>Replace</i> with the following:</p> <p>The test shall be made on one specimen. If the specimen does not withstand the test, the test may be repeated on two further specimens, both of which shall withstand the test.</p>		N/A
<b>Clause of AS/NZS 60695.11.5</b>	Change										
<b>9 Test procedure</b>											
<b>9.2 Application of needle-flame</b>	<p><i>Delete</i> the first and second paragraphs and <i>replace</i> with the following:</p> <p>The specimen shall be arranged so that the flame can be applied to a vertical or horizontal edge as shown in the examples of Figure 1. If possible the flame shall be applied at least 10 mm from a corner.</p> <p>The duration of application of the test flame shall be 30 s ± 1 s.</p>										
<b>9.3 Number of test specimens</b>	<p><i>Replace</i> with the following:</p> <p>The test shall be made on one specimen. If the specimen does not withstand the test, the test may be repeated on two further specimens, both of which shall withstand the test.</p>										

IEC62368_1B - ATTACHMENT			
Clause	Requirement + Test	Result - Remark	Verdict
	<p><b>11 Evaluation of test results</b></p> <p><i>Replace with the following:</i></p> <p>The duration of burning (tb) shall not exceed 30 s.</p> <p>However, for printed circuit boards, it shall not exceed 15 s.</p>		
	<p>The needle-flame test shall not be carried out on parts of material classified as V-0 or V-1 according to AS/NZS 60695.11.10, provided that the relevant part is not thinner than the sample tested.</p>		
6.202.4	<p><b>Testing in the event of non-extinguishing material</b></p> <p>If parts, other than enclosures, do not withstand the glow wire tests of Clause 6.202.3, by failure to extinguish within 30 s after the removal of the glowwire tip, the needle-flame test detailed in Clause 6.202.3 shall be made on all parts of non-metallic material which are within a distance of 50 mm or which are likely to be impinged upon by flame during the tests of Clause 6.202.3. Parts shielded by a separate barrier which meets the needle-flame test need not be tested.</p> <p>NOTE 1: If the enclosure does not withstand the glow-wire test the equipment is considered to have failed to meet the requirements of Clause 6.202 without the need for consequential testing.</p> <p>NOTE 2: If other parts do not withstand the glow-wire test due to ignition of the tissue paper and if this indicates that burning or glowing particles can fall onto an external surface underneath the equipment, the equipment is considered to have failed to meet the requirements of Clause 6.202 without the need for consequential testing.</p> <p>NOTE 3: Parts likely to be impinged upon by the flame are considered to be those within the envelope of a vertical cylinder having a radius of 10 mm and a height equal to the height of the flame, positioned above the point of the material supporting, in contact with, or in close proximity to, connections.</p>		N/A

IEC62368_1B - ATTACHMENT			
Clause	Requirement + Test	Result - Remark	Verdict
6.202.5	<p><b>Testing of printed boards</b></p> <p>The base material of printed boards shall be subjected to the needle-flame test of Clause 6.202.3. The flame shall be applied to the edge of the board where the heat sink effect is lowest when the board is positioned as in normal use. The flame shall not be applied to an edge, consisting of broken perforations, unless the edge is less than 3 mm from a potential ignition source.</p> <p>The test is not carried out if—</p> <ul style="list-style-type: none"> <li>– the printed board does not carry any potential ignition source;</li> <li>– the base material of printed boards, on which the available apparent power at a connection exceeds 15 VA operating at a voltage exceeding 50 V and equal or less than 400 V (peak) a.c. or d.c. under normal operating conditions, is of flammability category V-1 or better according to AS/NZS 60695.11.10, or the printed boards are protected by an enclosure meeting the flammability category V-0 according to AS/NZS 60695.11.10, or made of metal, having openings only for connecting wires which fill the openings completely; or</li> <li>– the base material of printed boards, on which the available equipment power at a connection exceeds 15 VA operating at a voltage exceeding 400 V (peak) a.c. or d.c. under normal operating conditions, and base material of printed boards supporting spark gaps which provides protection against overvoltages, is of flammability category V-0 according to AS/NZS 60695.11.10 or the printed boards are contained in a metal enclosure, having openings only for connecting wires which fill the openings completely.</li> </ul> <p><i>Conformance shall be determined using the smallest thickness of the material.</i></p> <p>NOTE: Available apparent power is the maximum apparent power which can be drawn from the supplying circuit through a resistive load whose value is chosen to maximize the apparent power for more than 2 min when the circuit supplied is disconnected.</p>		N/A

IEC62368_1B - ATTACHMENT			
Clause	Requirement + Test	Result - Remark	Verdict
6.202.6	<p><b>For open circuit voltages greater than 4 kV</b> Potential ignition sources with open circuit voltages exceeding 4 kV (peak) a.c. or d.c. under normal operating conditions shall be contained in a FIRE ENCLOSURE which shall comply with flammability category V-1 or better according to AS/NZS 60695.11.10.</p>		N/A
8.6.1.201	<p><b>8.6.1.201 Instructional safeguard for fixed-mount television sets</b> MS2 and MS3 television sets and display devices designed only for fixed mounting to a wall of ceiling or equipment rack shall, where required in Table 36, footnote 201, have an instructional safeguard in accordance with Clause F.5 which may be on the equipment or included in the installation instructions or equivalent document accompanying the equipment. The elements of the instructional safeguard shall be as follows: – element 1a: not available; – element 2: 'Stability Hazard' or equivalent wording; – element 3: 'The television set may fall, causing serious personal injury or death' or equivalent text; – element 4: the following or equivalent text: To prevent injury, this television set must be securely attached to the floor/wall in accordance with the installation instructions</p>		N/A
8.6.1.202	<p><b>Restraining device</b> MS2 and MS3 television sets and display devices that are not solely fixed-mounted should be provided with a restraining device such as a fixing point to facilitate restraining the equipment from toppling forward. The restraining device shall be capable of withstanding a pull of 100 N in all directions without damage. Where a restraining device is provided, instructions shall be provided in the instructions for installation or instructions for use to ensure correct and safe installation.</p>		N/A



IEC62368_1B - ATTACHMENT			
Clause	Requirement + Test	Result - Remark	Verdict

<b>ATTACHMENT TO TEST REPORT</b> <b>IEC 62368-1</b> <b>(JAPAN) NATIONAL DIFFERENCES</b> (Audio/video, information and communication technology equipment – Part 1: Safety requirements)			
<b>Differences according to</b> ..... : J62368-1 (H30)			
<b>Attachment Form No.</b> ..... : JP_ND_IEC62368_1B			
<b>Attachment Originator</b> ..... : UL (JP)			
<b>Master Attachment</b> ..... : Date 2018-11-22			
<b>Copyright © 2018 IEC System for Conformity Testing and Certification of Electrical Equipment (IECEE), Geneva, Switzerland. All rights reserved.</b>			
	<b>National Differences</b>		—
4.1.2	Where the component, or a characteristic of a component, is a safeguard or a part of a safeguard, components shall comply with the requirements of this standard or, where specified in a requirements clause, with the safety aspects of the relevant JIS component standards or IEC component standards, or components shall have properties equivalent to or better than these.		P
5.6.1	Mains socket-outlet and appliance outlet shall comply with Clause G.4.2A if they are incorporated as part of the equipment.		N/A
5.6.2.1	Mains connection of class 0I equipment: Instructional safeguard in accordance with Clause F.3.6.1A; Mains plug having a lead wire for protective earthing connection of class 0I equipment; Independent main protective earthing terminal installed by ordinary person.	Class II	N/A
5.6.2.2	This requirement does not apply to internal conductor of the cord set that is covered by the sheath of mains cord and is formed together with mains plug and appliance connector.		N/A



IEC62368_1B - ATTACHMENT			
Clause	Requirement + Test	Result - Remark	Verdict
5.6.3	In case of class 0I equipment using power supply cord having two conductors (no earthing conductor), the conductor of protective earthing lead wire shall comply with either of the following: – use of annealed copper wire with 1.6 mm diameter or corrosion-inhibiting metal wire having size and strength that are equivalent to or more than the above copper wire – single core cord or single core cable with 1.25 mm <sup>2</sup> or more cross-sectional area		N/A
5.7.3	For class 0I equipment that is provided with mains socket-outlet in the configuration as specified in JIS C 8282 series or JIS C 8303, or otherwise being considered to comply with relevant regulations, or that is provided with mains appliance outlet as specified in JIS C 8283-2-2 for the purpose of interconnection, the measurement is conducted on the system of the interconnected equipment having a single connection to the mains.		N/A
5.7.4	In case of class 0I equipment, touch current shall not exceed 1.41 mA peak or for sinusoidal wave, 1.0 mA r.m.s. when measured using the network specified in Figure 4 of IEC 60990.		N/A
6.4.3.3	A fuse complying with JIS C 6575 series or a fuse having equivalent characteristics shall open within 1 s. For Class A fuse of JIS C 6575, replace “2.1 times” by “1.35 times” and in case of Class B fuse of JIS C 6575, replace “2.1 times” by “1.6 times”. A fuse not complying with JIS C 6575 series shall be tested with the breaking capacity taken into account.	Test with appliance	P
8.5.4.2.1	Only three-phase stationary equipment rated more than 200 V ac can be considered as being for use in locations where children are not likely to be present, when complying with Clause F.4.		N/A
8.5.4.2.2	For equipment installed where children may be present, an instructional safeguard shall be provided by easily understandable wording in accordance with Clause F.5, except that element 3 is optional.		P

IEC62368_1B - ATTACHMENT			
Clause	Requirement + Test	Result - Remark	Verdict
8.5.4.2.4	The media destruction device is tested according to Clause V.1.2 with applicable jointed test probes to the opening. And then the wedge probe per Figure V.4 shall not contact any moving part.		P
8.5.4.2.5	The wedge probe of Figure V.4 and applicable jointed test probes specified in Clause V.1.2 shall not contact any moving part. Instructional safeguard shall not be used instead of equipment safeguard for preventing access to hazardous moving parts.		P
9.2.6, Table 38	Handles, Knobs, grips, etc. and external surfaces either held, touched or worn against the body in normal use (> 1 min) <sup>b,c</sup>		N/A
F.3.5.1	Instructional safeguard of class 0I equipment in accordance with Clause F.5 when a mains socket-outlet as specified in JIS C 8282 series, JIS C 8303 or relevant regulation to which class I equipment can be connected is provided in accordance with Clause G.4.2A except for the cases where the socket-outlet is accessible only to skilled persons.	Class II	N/A
F.3.5.3	If the fuse is necessary for the safeguard function, the symbols indicating pre-arcing time-current characteristic.		N/A
F.3.6.1A	Marking for class 0I equipment The requirements of Clauses F.3.6.1.1 and F.3.6.1.3 shall be applied to class 0I equipment. For class 0I equipment, a marking of instructions and instructional safeguard shall be provided regarding the earthing connection.		N/A
F.3.6.2.1	Symbols, IEC 60417-5172 (2003-02) or IEC 60417-6092 (2011-10), shall not be used for class I equipment or class 0I equipment.		P
F.4	Instruction for audio equipment with terminals classified as ES3 in accordance with Table E.1, and for other equipment with terminals marked in accordance with F.3.6.1 and F.3.6.1A. Installation instruction for the protective earthing connection for class 0I equipment provided with independent main protective earthing terminal, where the cord for the protective earthing connection is not provided within the package for the equipment.		N/A

IEC62368_1B - ATTACHMENT			
Clause	Requirement + Test	Result - Remark	Verdict
G.3.2.1	The thermal link when tested as a separate component, shall comply with the requirements of JIS C 6691 or have properties equivalent to or better than that.	No such component	N/A
G.3.4	Except for devices covered by Clause G.3.5, overcurrent protective devices used as a safeguard shall comply with the relevant part of JIS C 6575 (corresponding to IEC60127) or shall have equivalent characteristics.  If there are no applicable IEC standards, overcurrent protective devices used as a safeguard shall comply with their applicable IEC standards.		P
G.4.1	This requirement is not applicable to Clauses G.4.2 and G.4.2A.		N/A
G.4.2	Mains connector shall comply with JIS C 8282 series, JIS C 8283 series, JIS C 8285, JIS C 8303 or IEC 60309 series.  Mains plugs and socket-outlets shall comply with JIS C 8282 series, JIS C 8303, IEC 60309 series, or have equivalent or better performance.  A power supply cord set provided with appliance connector that can fit appliance inlet complying with JIS C 8283-1 shall comply with JIS C 8286.  Construction preventing mechanical stress not to transmit to the soldering part of inlet terminal.  Consideration for an equipment rated not more than 125 V provided with Type C14 and C18 appliance coupler complying with JIS C 8283 series.	Direct plug-in equipment. Shall be evaluated during national approval	N/A
G.4.2A	Mains socket-outlet and interconnection coupler provided with the class II, class I and class 0I equipment respectively.		N/A
G.7.1	A mains supply cord need not include the protective earthing conductor for class 0I equipment provided with independent protective earthing conductor.		N/A
G.8.3.3	Withstand $1,71 \times 1.1 \times U_0$ for 5 s.		N/A

-END-

EN 50075 (Partial)			
Clause	Clause	Clause	Clause

**European plug portion test**

<b>6</b>	<b>Marking</b>		<b>P</b>
	Appliances shall be marked as follows:	Incorporated with adaptor.	<b>P</b>
	Rated current in amperes (A)		<b>P</b>
	Rated Voltage in volts (V)		<b>P</b>
	Symbol for nature of supply (~)		<b>P</b>
	Name, trade mark or identification mark of manufacturer or responsible vendor		<b>P</b>
	Type reference		<b>P</b>

<b>7</b>	<b>Dimensions</b>		<b>P</b>	
	Plug shall comply with Standard Sheet 1		<b>P</b>	
	Between two pins (pin base)	18.0 – 19.2 mm	18.48 mm	<b>P</b>
	Between two pins (pin top)	17.0 – 18.0 mm	17.55 mm	<b>P</b>
	Diameter of pin (metallic part)	4 <sup>±0.06</sup> mm	3.98 mm	<b>P</b>
	Diameter of pin (pin base)	max. 4.0 mm	3.94 mm	<b>P</b>
	Diameter of pin (middle part)	max. 3.8 mm	3.66 mm	<b>P</b>
	Pin length	19 <sup>±0.5</sup> mm	19.05 mm	<b>P</b>
	Length of pin except metal part	10 <sup>+ 1.0</sup> mm	10.64 mm	<b>P</b>
	Shape of pin top		Round shape mm	<b>P</b>
	Length of plug base	35.3 <sup>±0.7</sup> mm	35.50 mm	<b>P</b>
	Width of plug base	13.7 <sup>±0.7</sup> mm	14.22 mm	<b>P</b>
	Diagonal dimension of plug base within a distance of 18mm	26.1 <sup>±0.5</sup> mm 26.1 <sup>±0.5</sup> mm	26.50 mm 26.42 mm	<b>P</b>
	Angle	45°	45 °	<b>P</b>
	Radius	R 5 -0, +1mm	5.64 mm	<b>P</b>

<b>8</b>	<b>Protection against electric shock</b>		<b>P</b>
8.1	Live parts of the plug not accessible (standard test finger)	Incorporated with adaptor.	<b>P</b>
8.2	No connection between one plug-pin and socket outlet		<b>P</b>
8.3	External parts of insulating material		<b>P</b>

<b>9</b>	<b>Construction</b>		<b>P</b>
9.1	Plugs are not replaceable	Incorporated with adaptor.	<b>P</b>
9.2	Switches, fuse, lampholder not incorporated		<b>P</b>
9.3	Solid pins	See clause 13	<b>P</b>
	Adequate mechanical strength		<b>P</b>

EN 50075 (Partial)			
Clause	Clause	Clause	Clause

9.4	Pins locked against rotation	See clause 13.1 & 13.4	<b>P</b>
	Adequate fixed into the body		<b>P</b>
9.5	Kind of connection		<b>P</b>
9.6	Easily to be withdrawn from socket-outlet	Incorporated with adaptor	<b>P</b>

<b>10</b>	<b>Resistance to humidity</b>		<b>P</b>
	-Humidity treatment for 48 hours	Tested with adaptor.	<b>P</b>

<b>11</b>	<b>Insulation resistance and electric strength</b>		<b>P</b>
11.1	Insulation resistance (500V, min 5M $\Omega$ )	200M $\Omega$	<b>P</b>
11.2	Electric strength (2000V)	(see appended table)	<b>P</b>

<b>13</b>	<b>Mechanical strength</b>		<b>P</b>
13.1	Pressed with 150N for 5 min		<b>P</b>
13.2	Tumbling barrel acc Tumbling barrel test: number of falls.....:	Weight: 46g 1000 times falls was conducted according to DIN VDE 0620-2-1:2013, item 24.2. Three samples tested. After the test, it was fulfilled the requirements of DIN VDE 0620-101:1992 item 7 figure 2 "gauge for interchangeability" and no damage.	<b>P</b>
	No damages after the test		<b>P</b>
	Requirements of clause 7 and 8.2 still fulfilled		<b>N/A</b>
13.3	Rubbing test of plug-pins: 10000 cycles, 4N		<b>P</b>
	No damage of the pins		<b>P</b>
13.4	Pull test at 70°C with 40N		<b>P</b>
	Pins not more than 1 mm displaced	Displacement: 0.1 mm	<b>P</b>

<b>14</b>	<b>Resistance to heat and to aging</b>		<b>P</b>
14.1	Sufficient resistant to heat	Incorporated with adaptor.	<b>P</b>
14.1.1	After 1 h in heating cabinet at 100°C no damage shown	Tested with adaptor.	<b>P</b>
14.1.2	After 1 h in heating cabinet at 80°C and a force of 20N through the jaws no damage shown		<b>P</b>
14.2	Aging test		<b>P</b>
	-at 70°C for 168h		<b>P</b>
	-at room temperature for 96h		<b>P</b>

## EN 50075 (Partial)

Clause	Clause	Clause	Clause
--------	--------	--------	--------

	No traces of cloth at a force of 5N		P
	No damage leads to non-compliance		P

<b>15</b>	<b>Current-carrying parts and connections resistance to heat and to aging</b>		<b>P</b>
15.1	Connections withstand the mechanical stresses occurring in normal use		P
15.2	Contact pressure not through isolating material		P
15.3	Current carrying parts of copper		P
	No electroplated coating when part is subjected to mechanical wear		P
	Other metals having a mechanical strength, an electrical conductivity and a resistance to corrosion		N/A

<b>16</b>	<b>Creepage distances, clearances and distances through insulation</b>		<b>P</b>
	Live parts of different polarity: 3mm	14.2mm	P
	Through insulation between live parts and accessible surfaces: 1.5mm	5.4mm	P

<b>17</b>	<b>Resistance of insulation material to abnormal heat and fire</b>		<b>P</b>
	Insulating material not unduly affected by abnormal heat and by fire	(see appended table)	P

EN 50075 (Partial)			
Clause	Clause	Clause	Clause

<b>11.1</b>	<b>TABLE: Insulation resistance measurements</b>	<b>P</b>
Measured between:		Result
Pins connected together and the body ( $\geq 5M\Omega$ )		1000M $\Omega$ <b>P</b>
Each pins in turn and the other, the latter being connected to the body ( $\geq 5M\Omega$ )		1000M $\Omega$ <b>P</b>
Note: --		

<b>11.2</b>	<b>TABLE: electric strength measurements</b>	<b>P</b>
Test voltage applied between:		Test voltage (V) Break down
Pins connected together and the body		2000VAC No
Each pins in turn and the other, the latter being connected to the body		2000VAC No
Note: --		

<b>17.3</b>	<b>TABLE: Resistance of insulating material to abnormal heat and to fire</b>	<b>P</b>
Parts that retain current-carrying parts in position: 750°C		<b>P</b>
Other parts: 650°C		<b>P</b>
Note: --		

EN 50075 (Partial)			
Clause	Clause	Clause	Clause

### Standard sheet 1

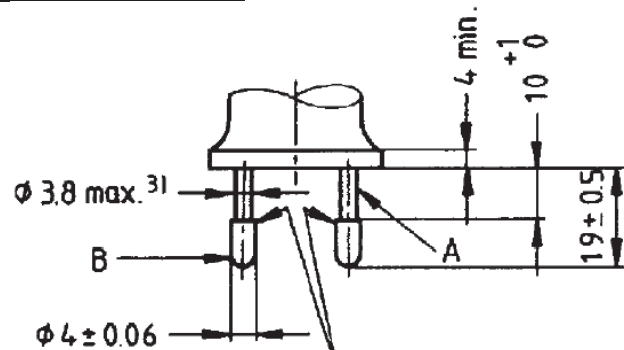
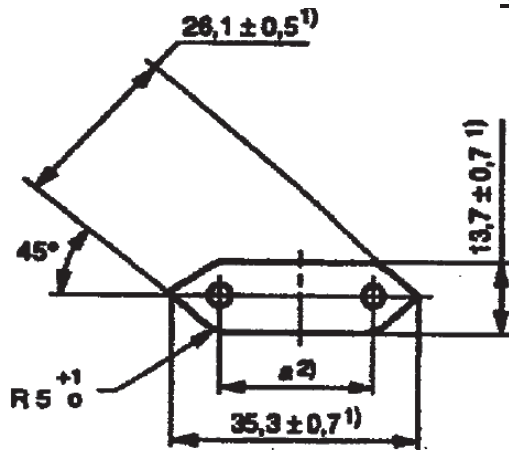

The edges of the metal parts shall be either chamfered or rounded off

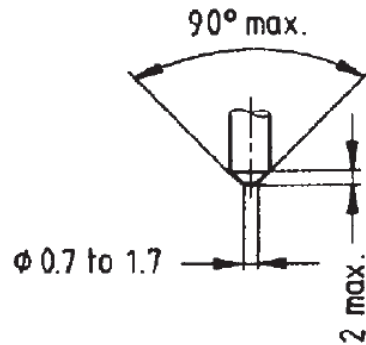

Alternative for end of pins

*Dimensions in millimetres*

A = insulating collar

B = metal pin

<sup>1)</sup> These dimensions shall not be exceeded within a distance of 18 mm from the engagement face of the plug.

<sup>2)</sup> Dimension  $a$  is:

18 mm to 19,2 mm in the plane of the engagement face;

17 mm to 18 mm at the ends of the pins.

<sup>3)</sup> This dimension may be increased to 4 mm within a distance of 4 mm from the engagement face of the plug.

Pin ends shall be rounded, or conical as shown in detail sketch.

The sketches are not intended to govern design except as regards the dimensions shown.



Model: GT-86122-WWVV-W2Z (WW, VV, Z are variables)



Picture 1



Picture 2

Model: GT-86122-WWVV-W2Z (WW, VV, Z are variables)



Picture 3



Picture 4

Model: GT-86122-WWVV-W2Z (WW, VV, Z are variables)



Picture 5

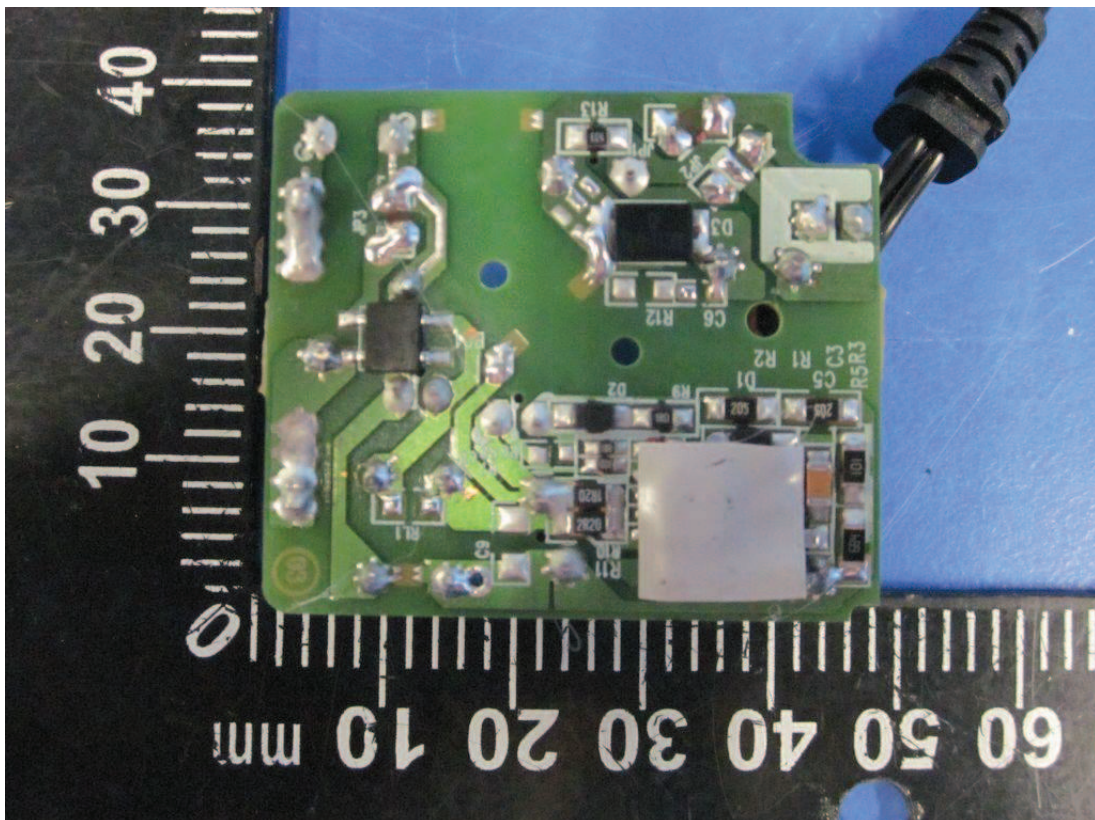

Picture 6 PCBA

Model: GT-86122-WWVV-W2Z (WW, VV, Z are variables)

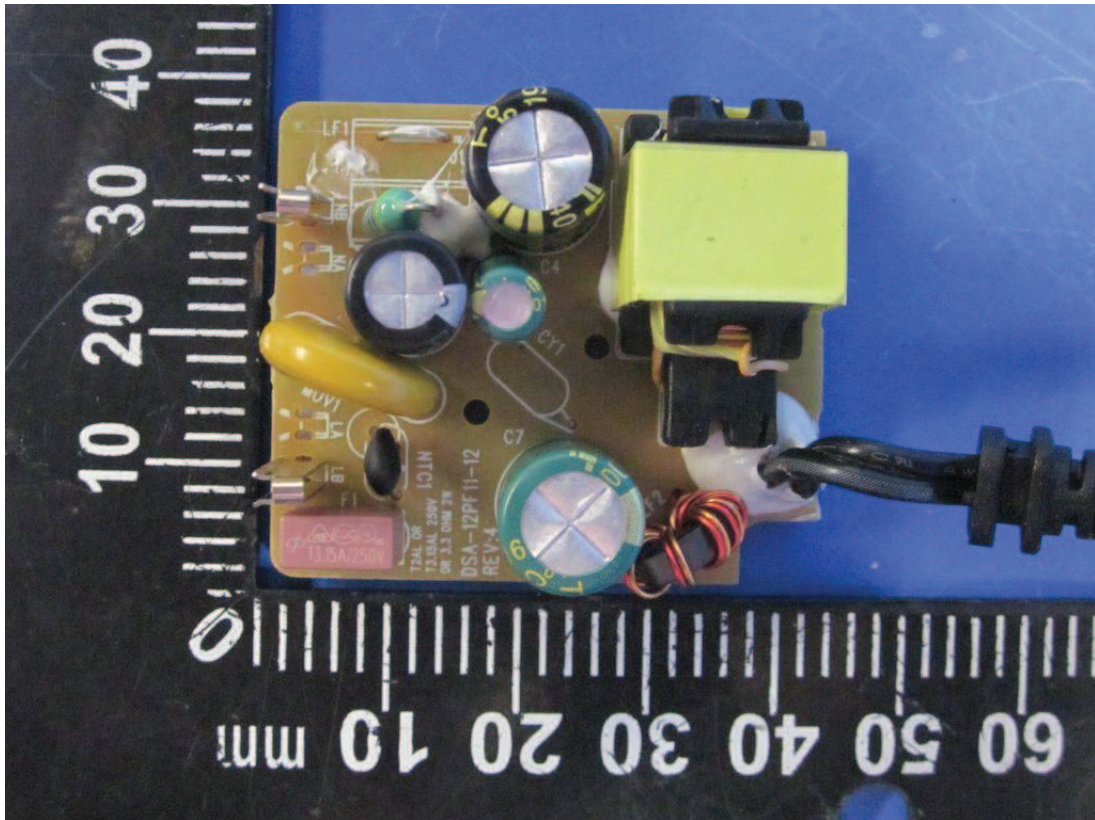

Picture 7 PCB A, Difference mode LF1, LF2, without CY1

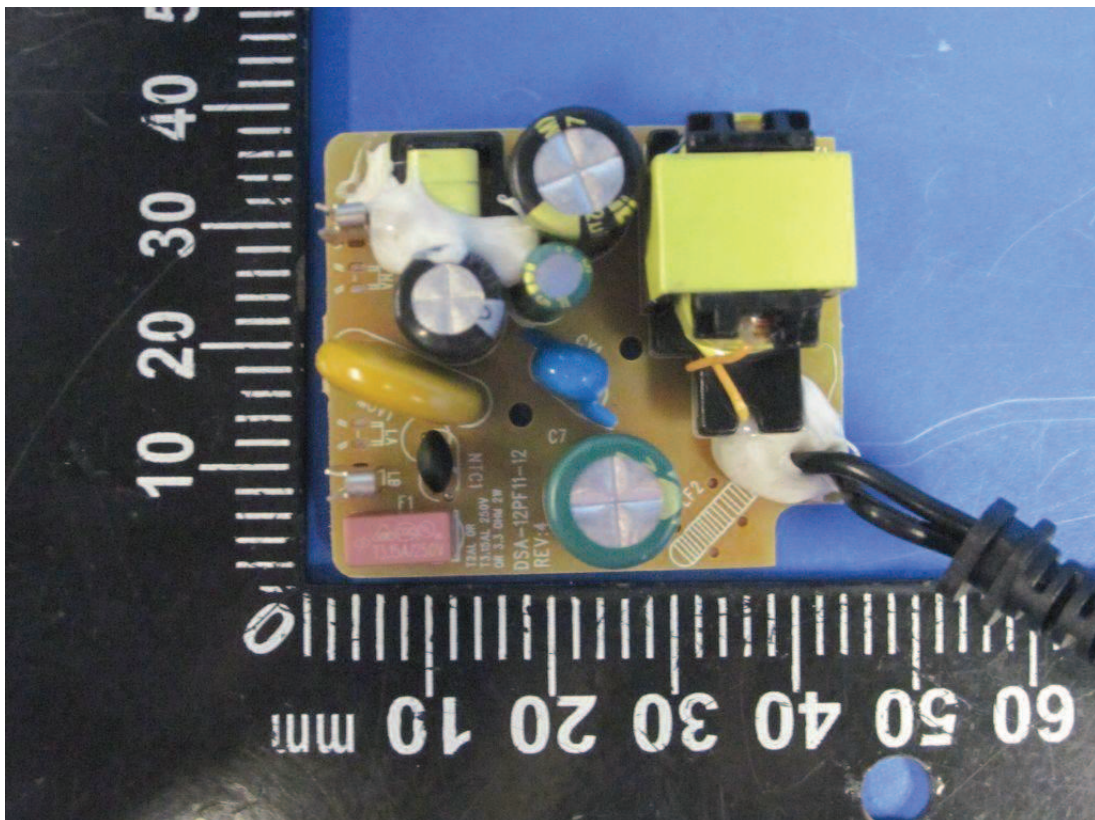

Picture 8 PCB A, Common mode LF1, without LF2, with CY1

Model: GT-86122-WWVV-W2Z (WW, VV, Z are variables)

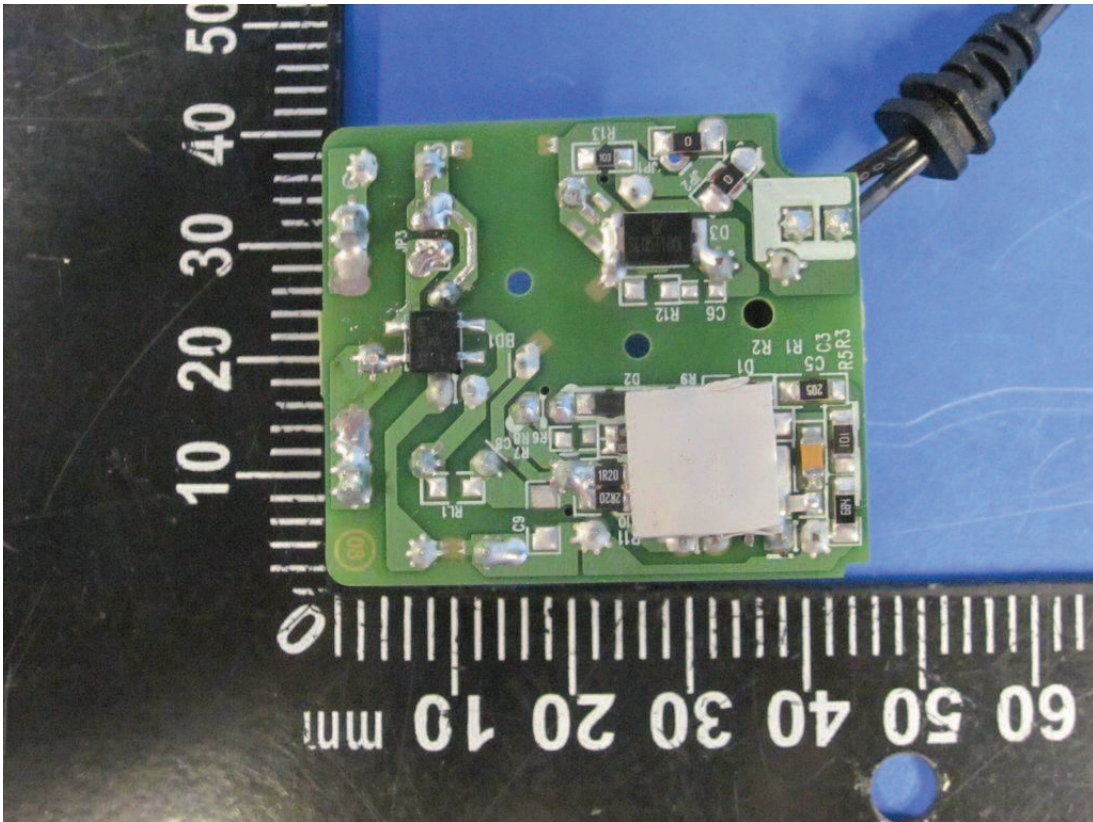

Picture 9 PCBA

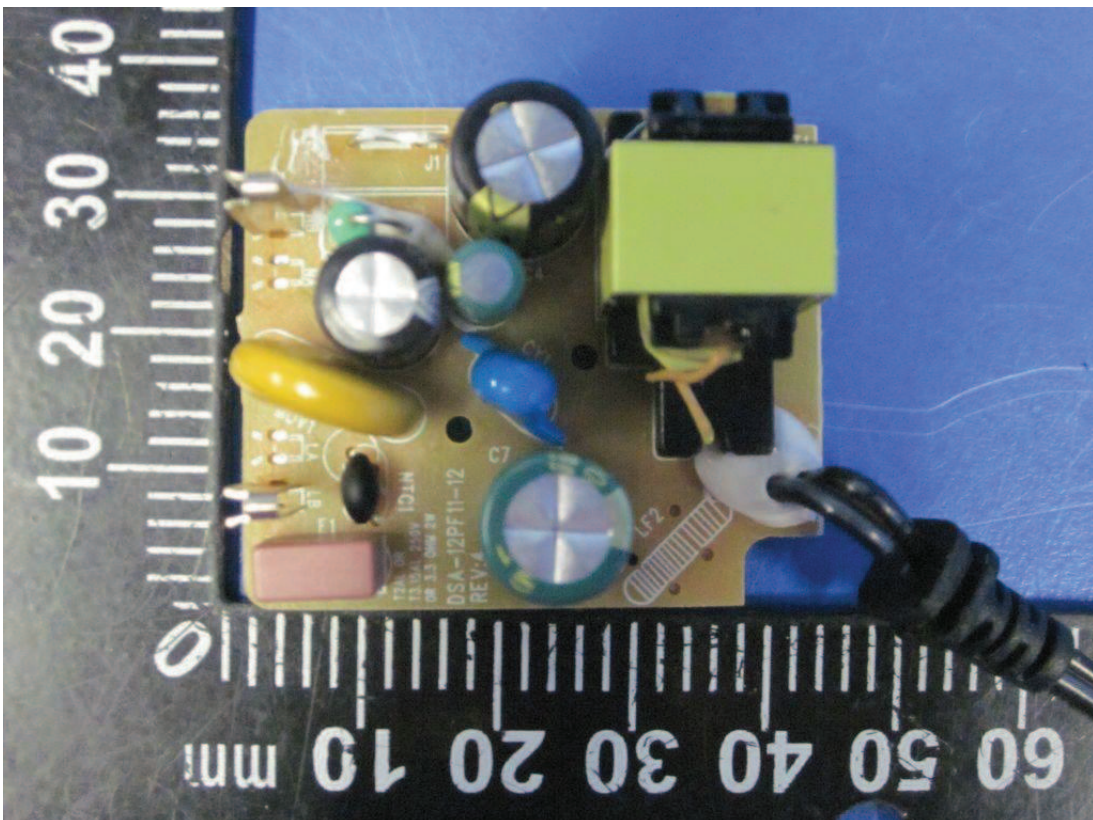

Picture 10 PCB A, Difference mode LF1, without LF2, with CY1

Model: GT-86122-WWVV-W2Z (WW, VV, Z are variables)

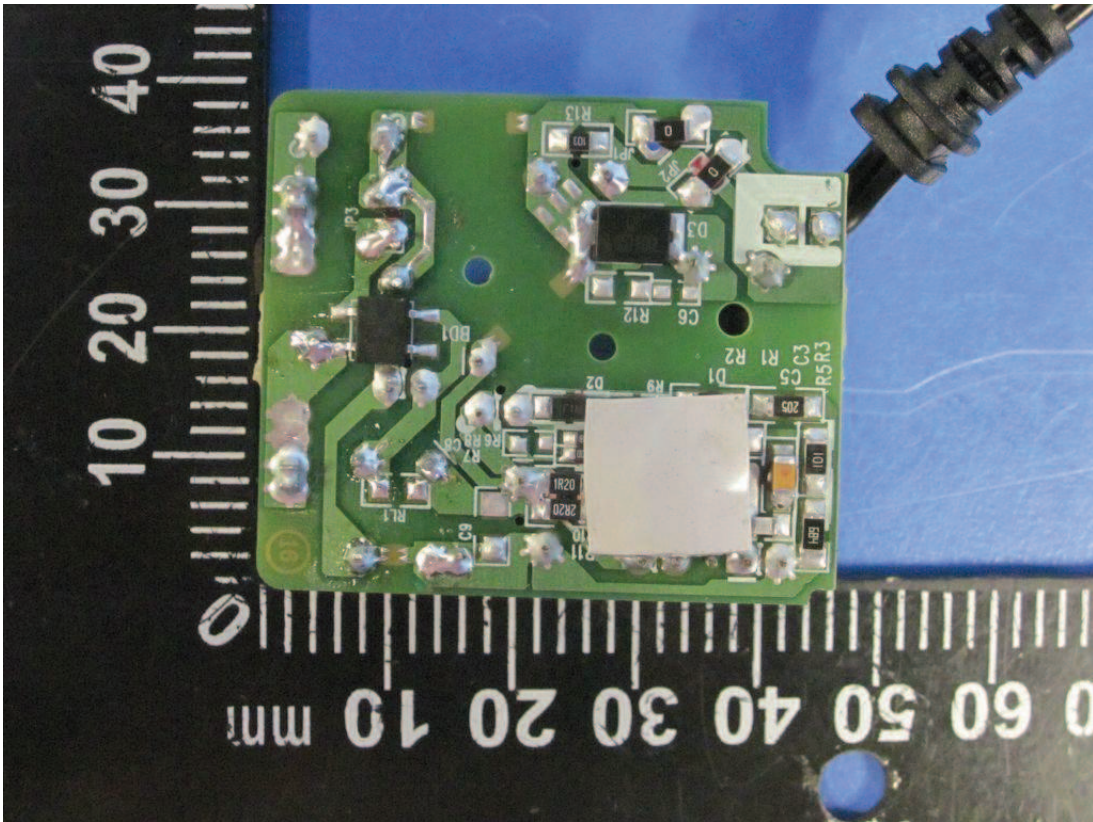

Picture 11 PCB A

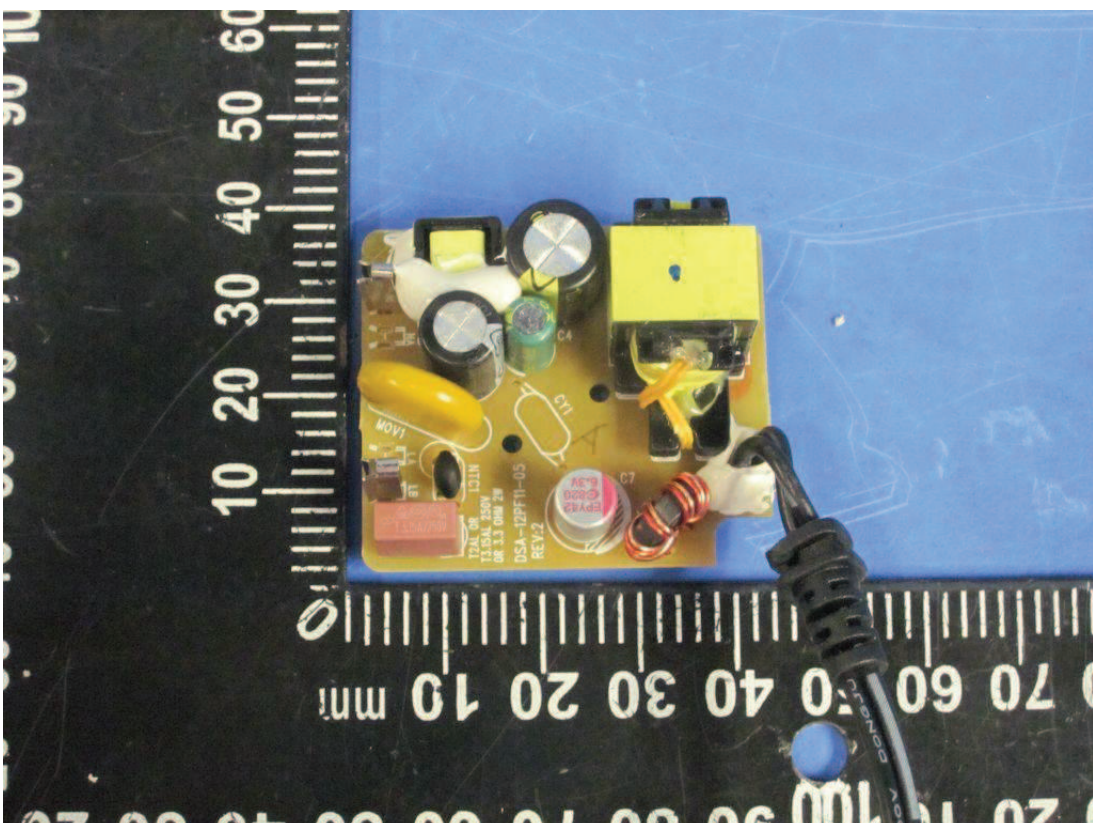

Picture 12 PCB B (configuration for LF1, LF2, CY1, see report description)

Model: GT-86122-WWVV-W2Z (WW, VV, Z are variables)

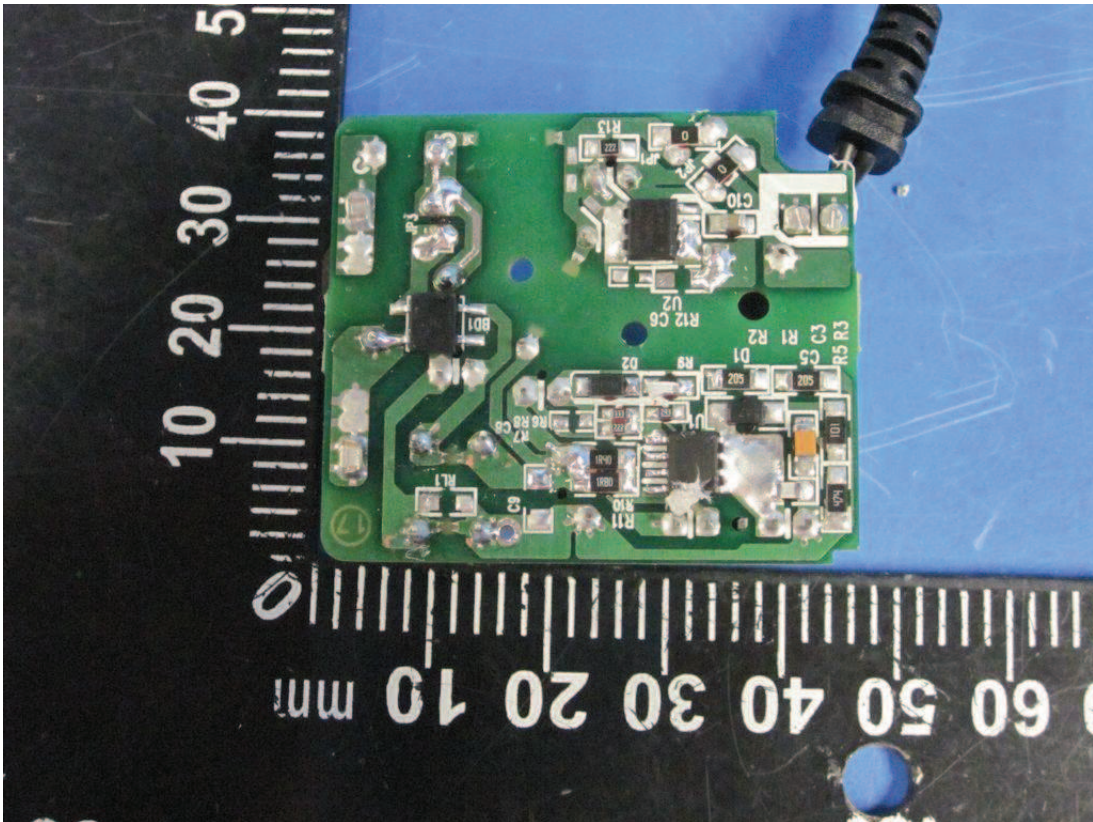

Picture 13 PCB B (configuration for LF1, LF2, CY1, see report description)

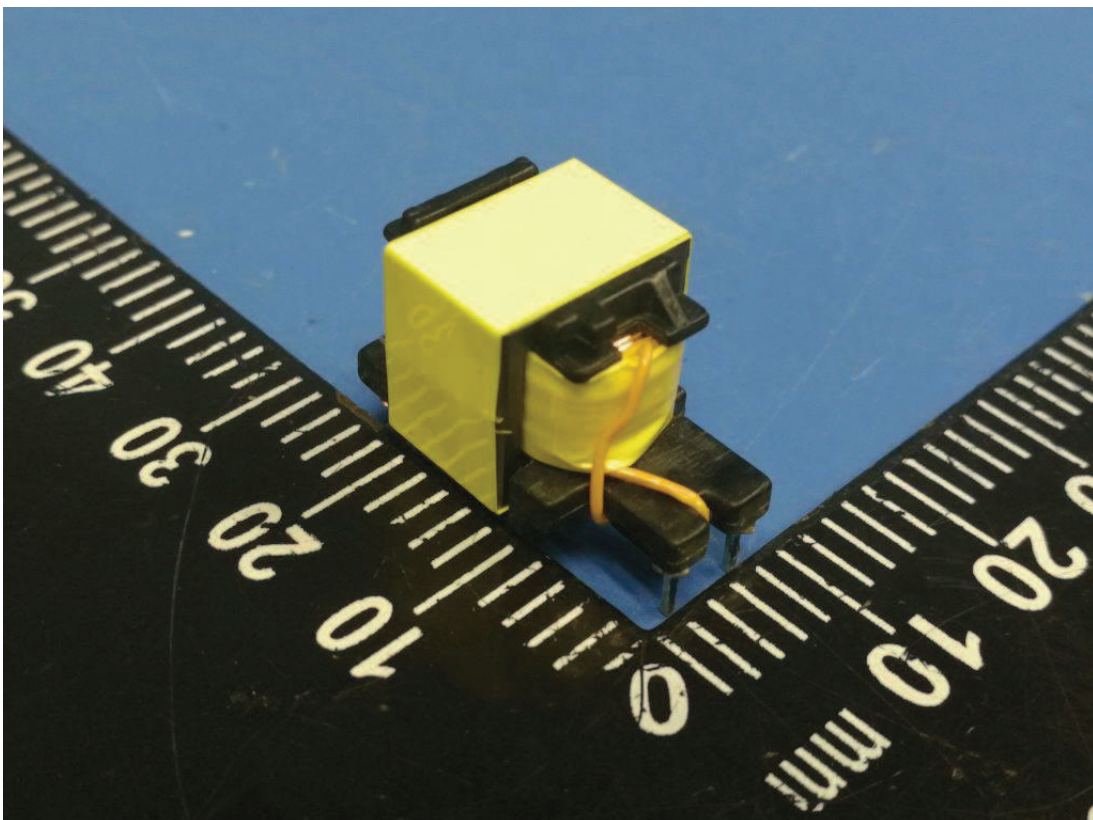

Picture 14

Model: GT-86122-WWVV-W2Z (WW, VV, Z are variables)

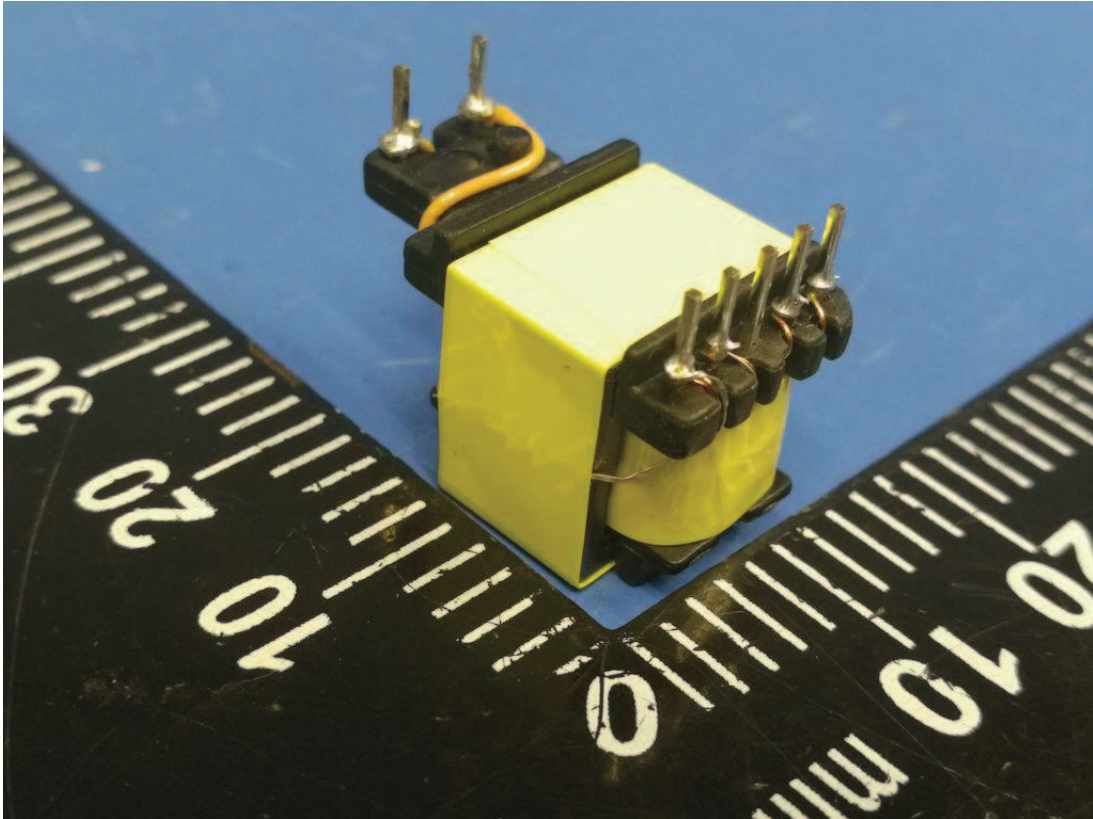

Picture 15

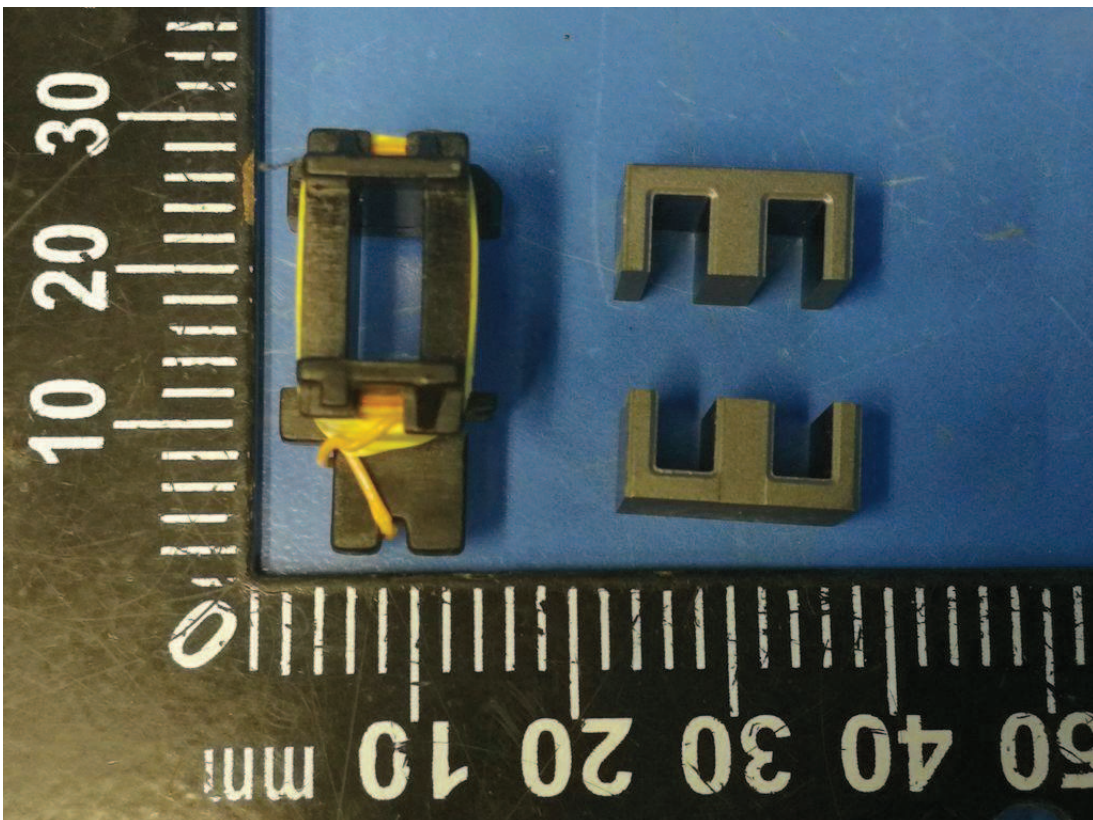

Picture 16



**Model:** GT-86122-WWVV-W2Z (WW, VV, Z are variables)

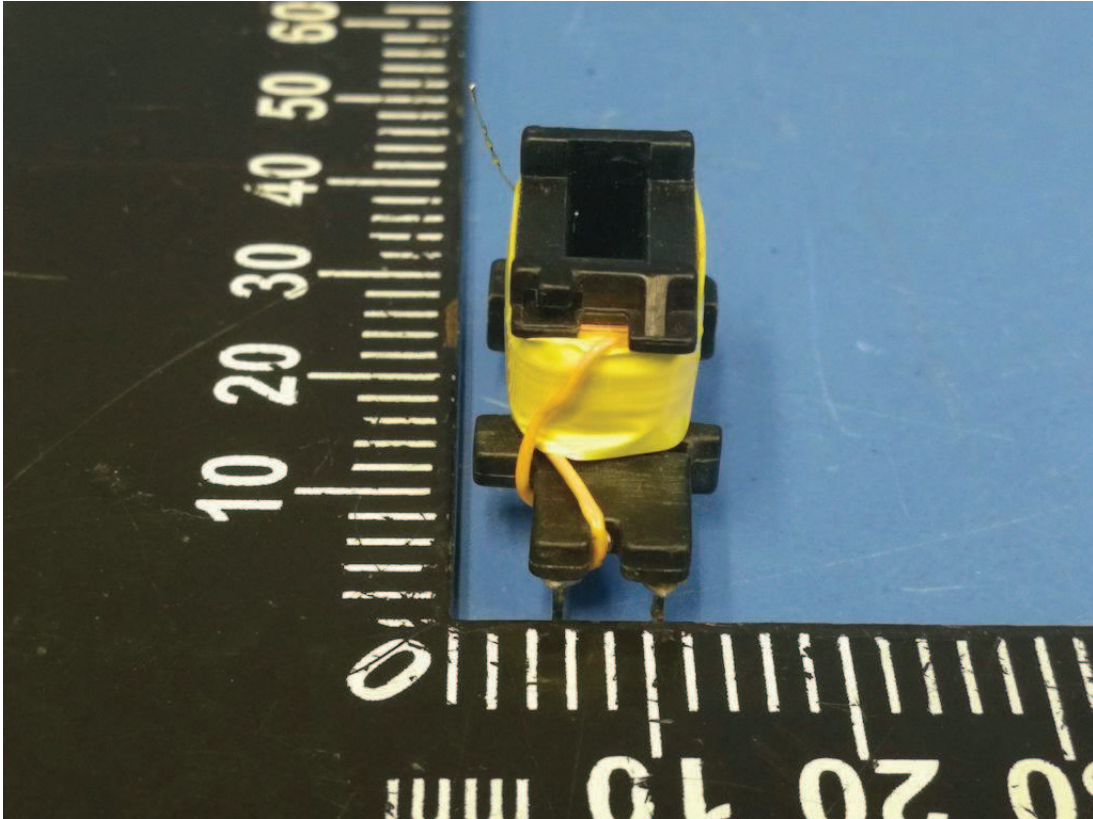

Picture 17

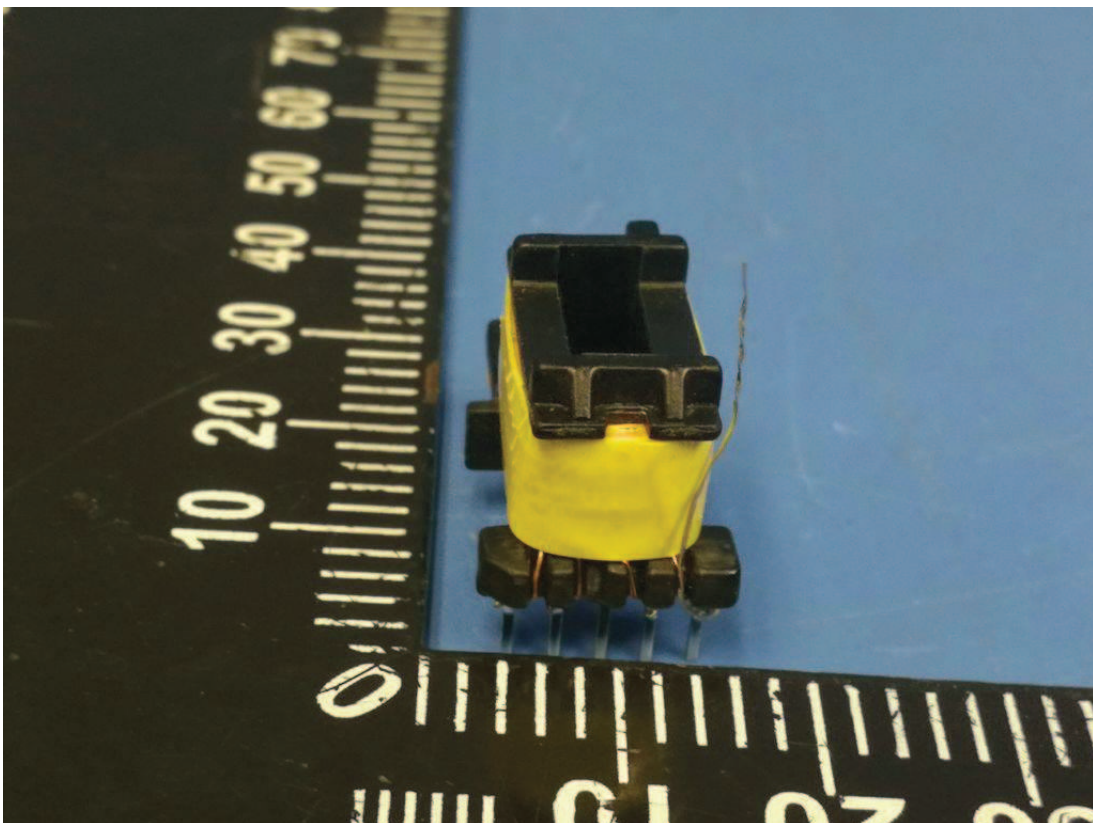

Picture 18

Model: GT-86122-WWVV-W2Z (WW, VV, Z are variables)

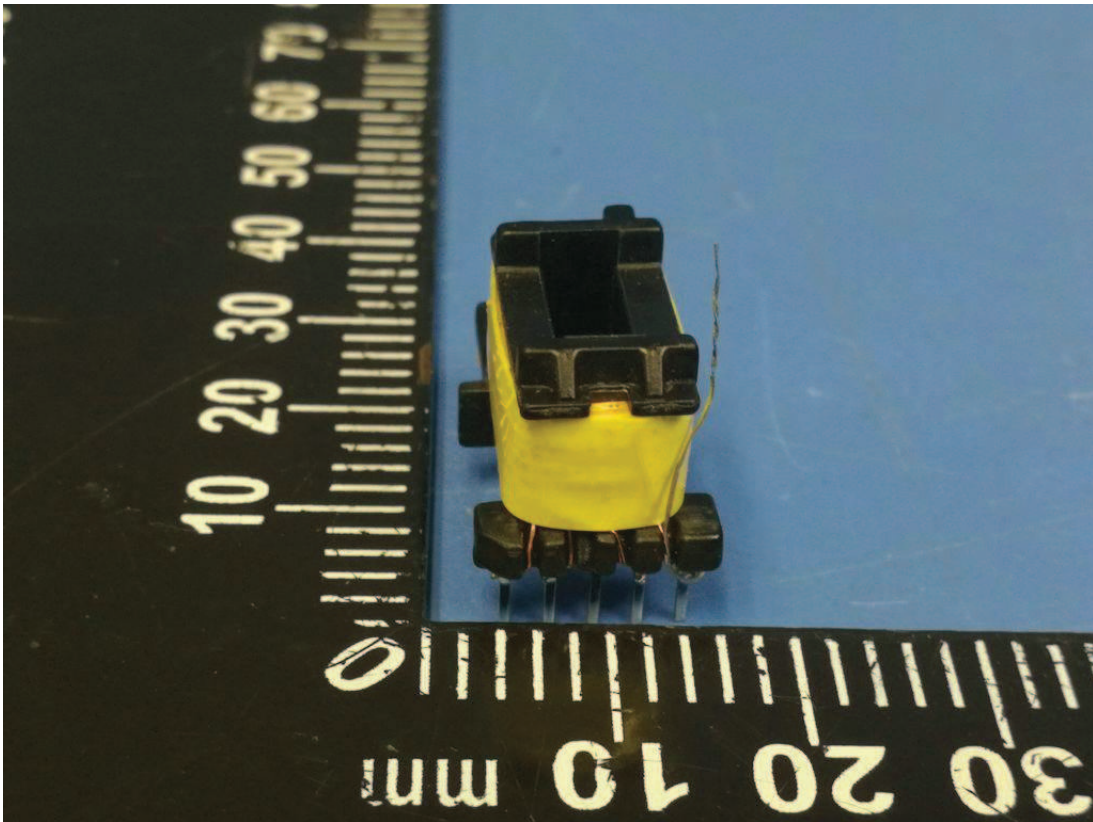

Picture 19

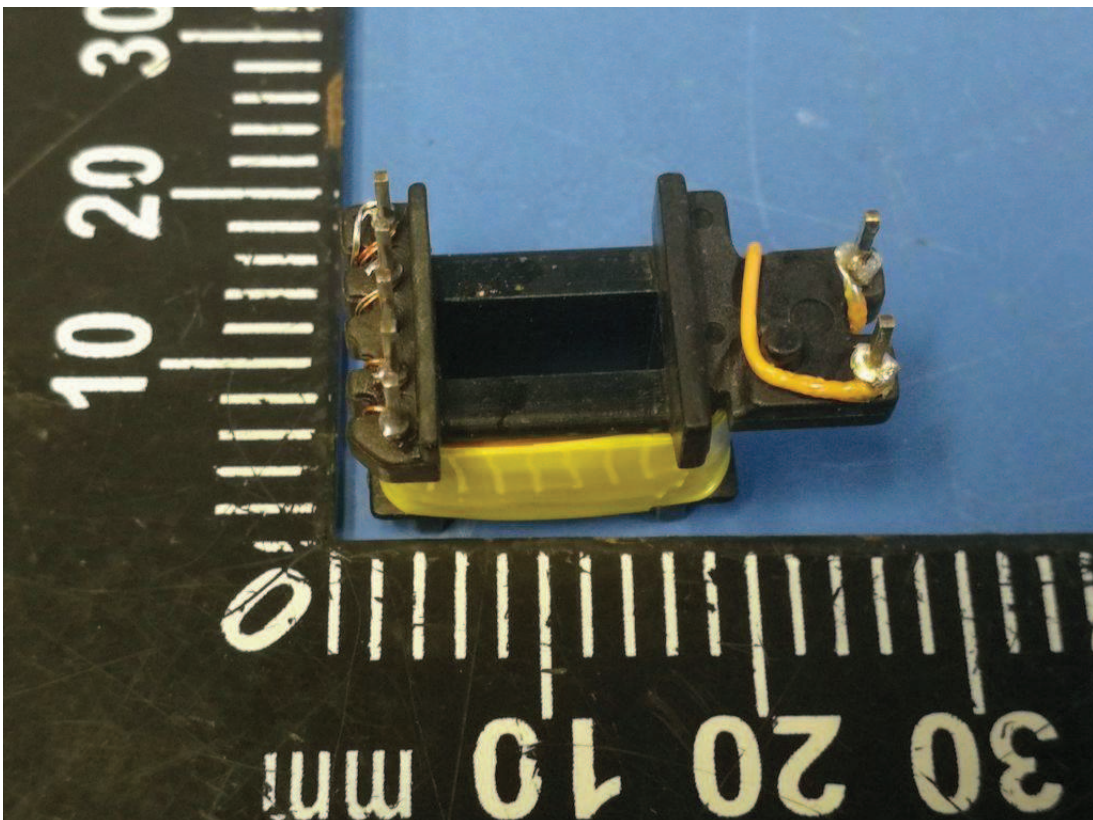

Picture 20

Model: GT-86122-WWVV-W2Z (WW, VV, Z are variables)

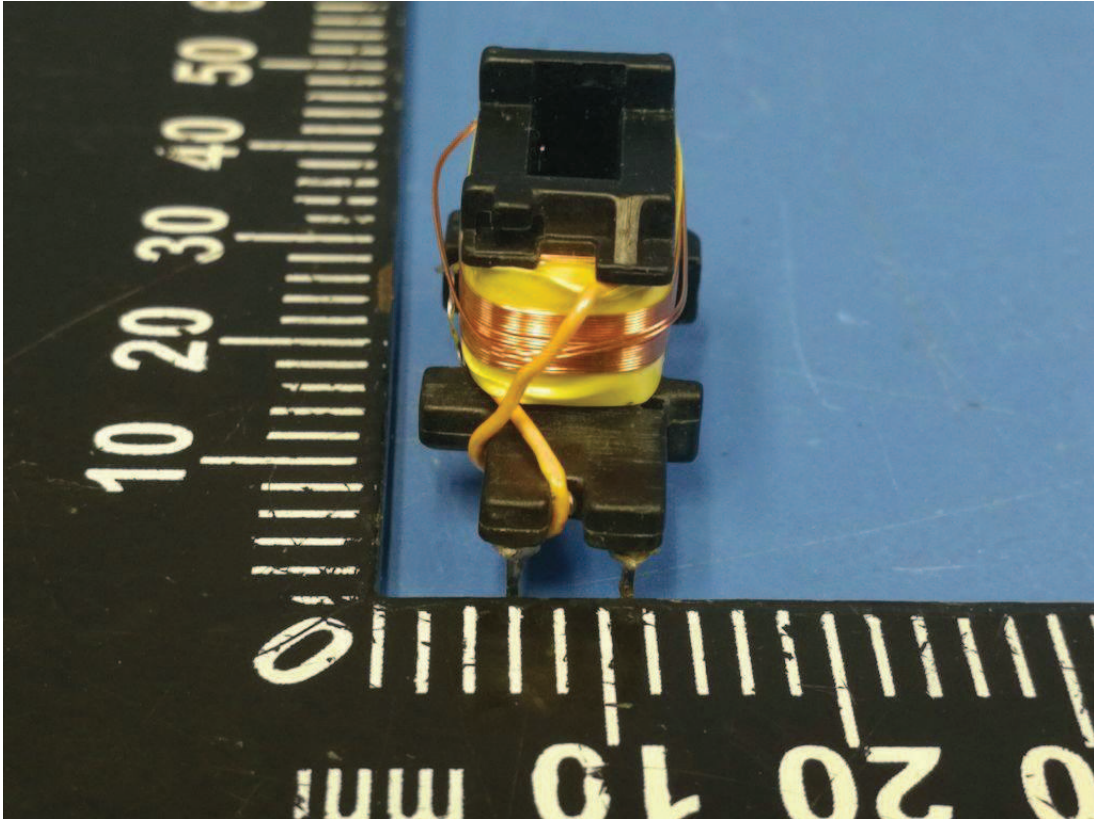

Picture 21

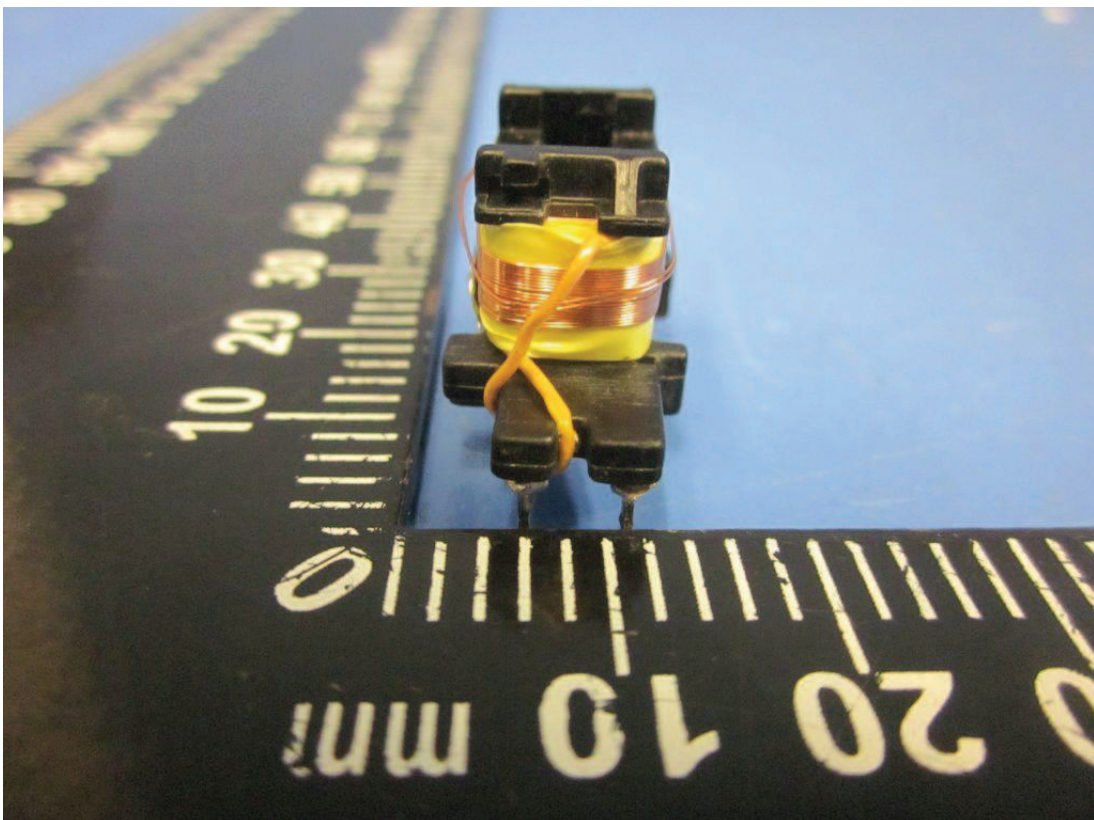

Picture 22

**Model:** GT-86122-WWVV-W2Z (WW, VV, Z are variables)

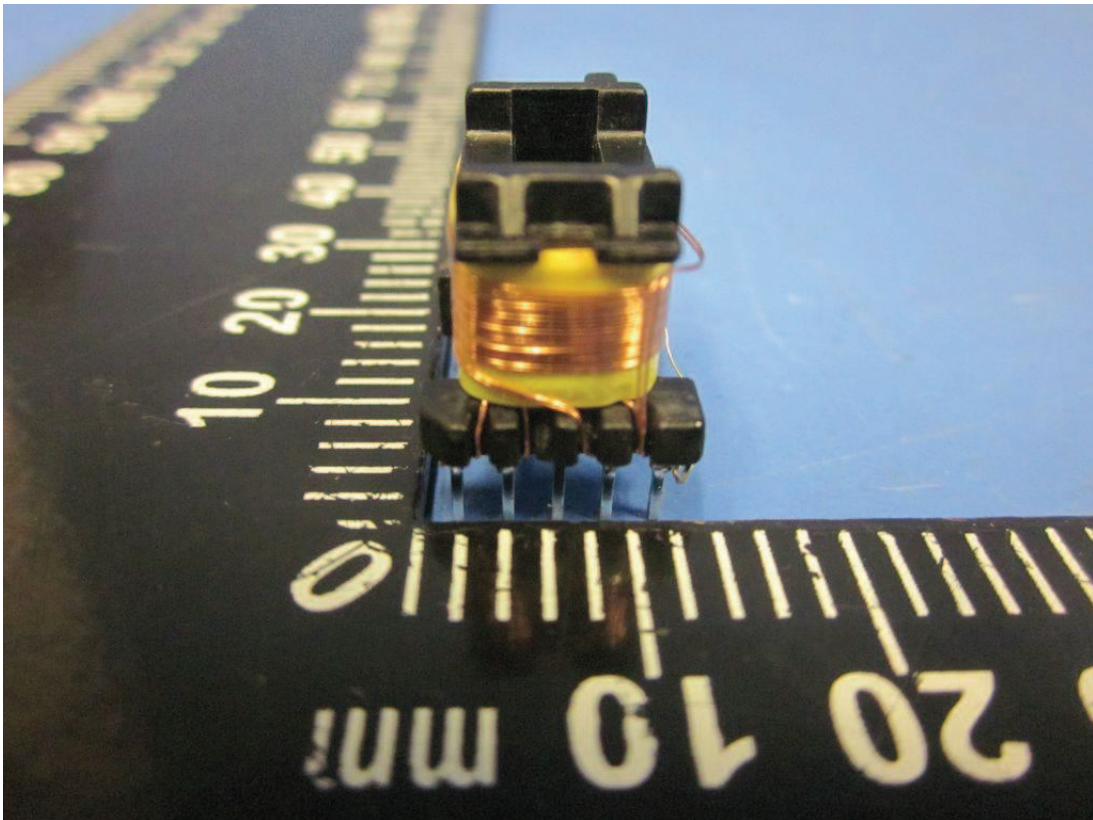

Picture 23

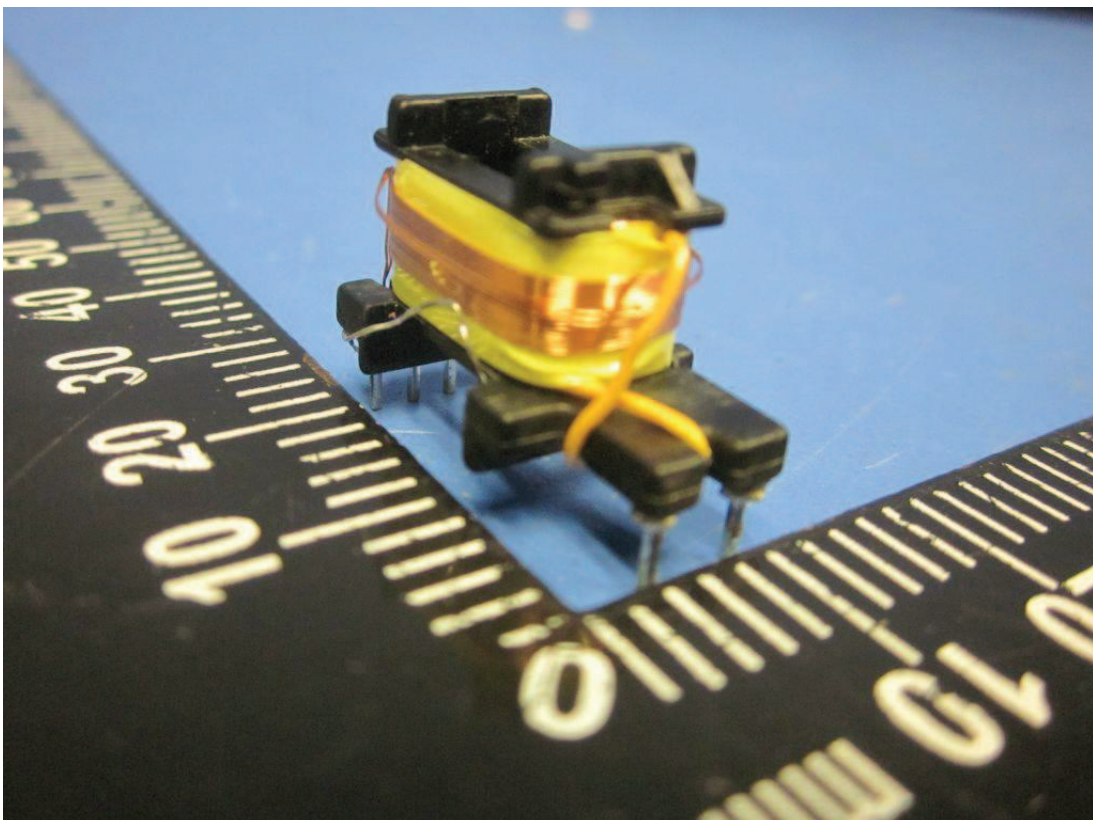

Picture 24

**Model:** GT-86122-WWVV-W2Z (WW, VV, Z are variables)

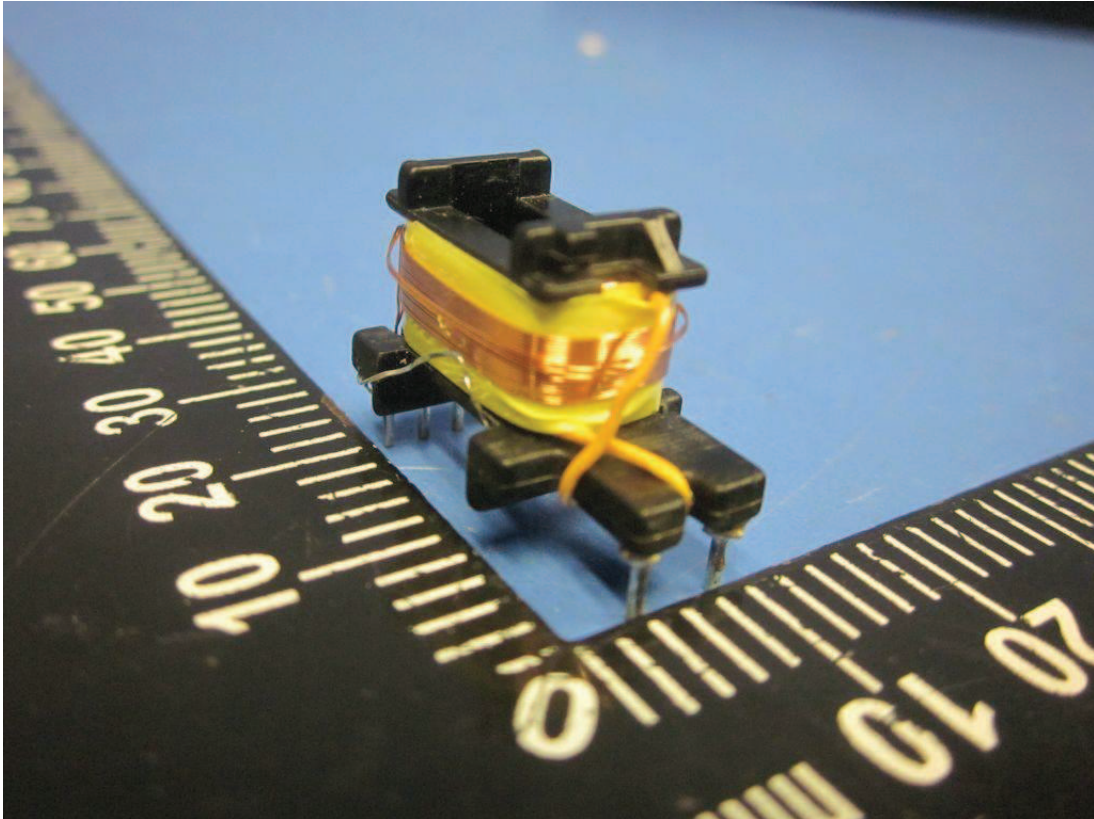

Picture 25

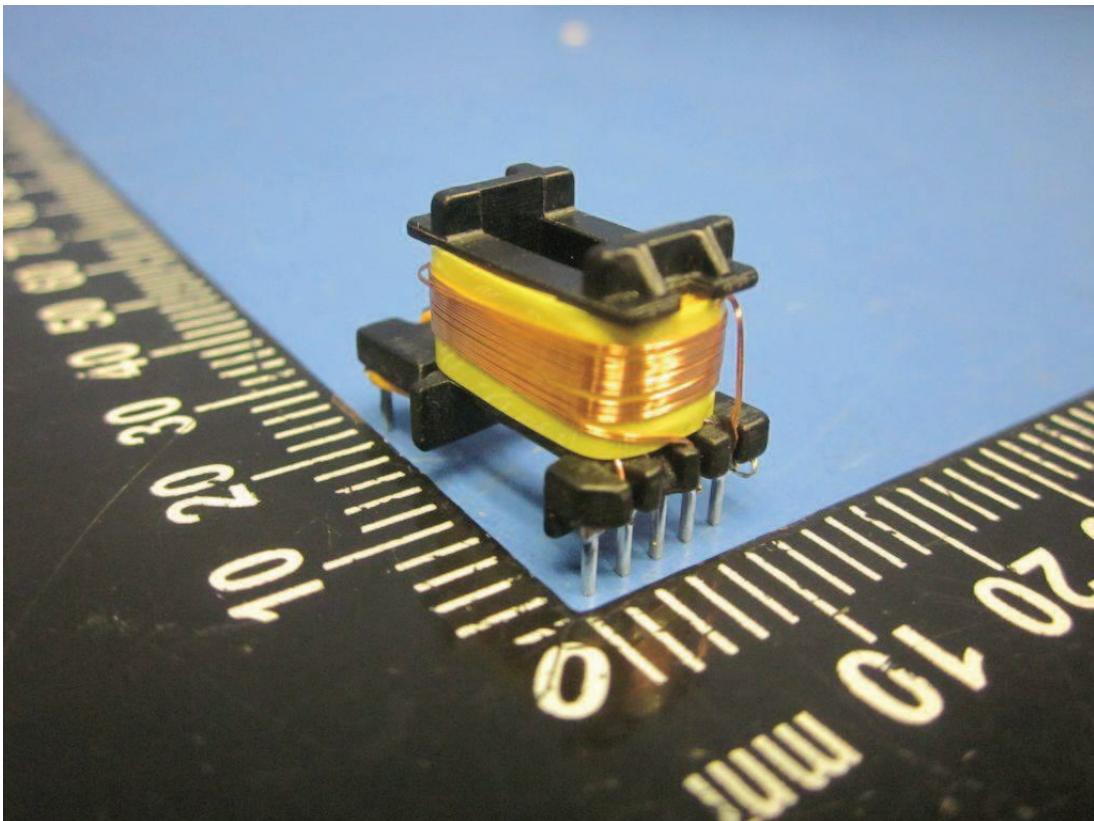

Picture 26

**Model:** GT-86122-WWVV-W2Z (WW, VV, Z are variables)

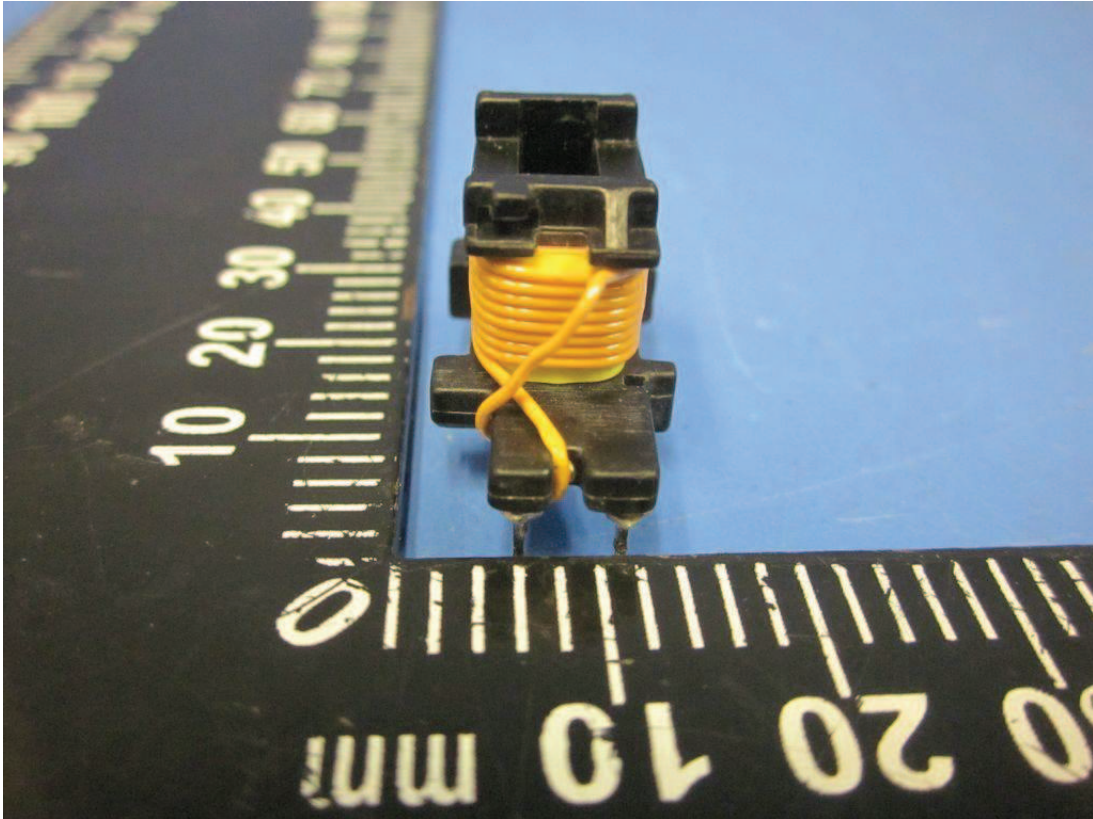

Picture 27

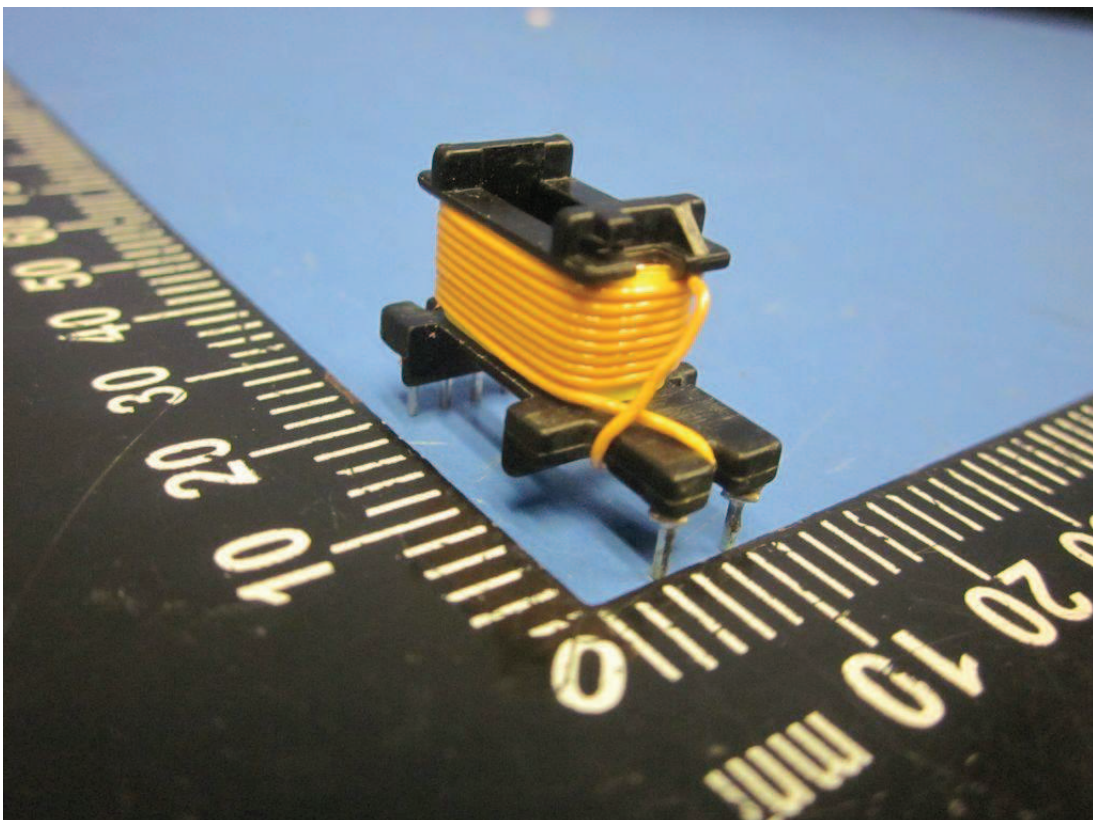

Picture 28

**Model:** GT-86122-WWVV-W2Z (WW, VV, Z are variables)

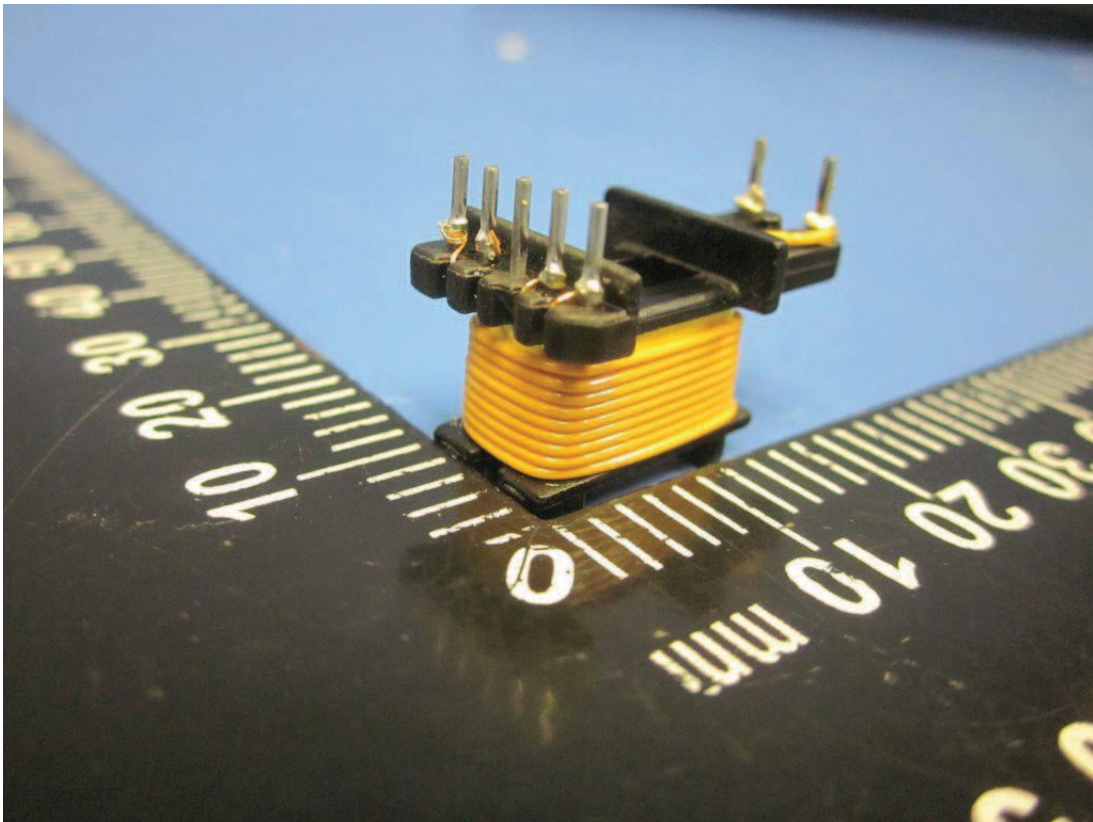

Picture 29

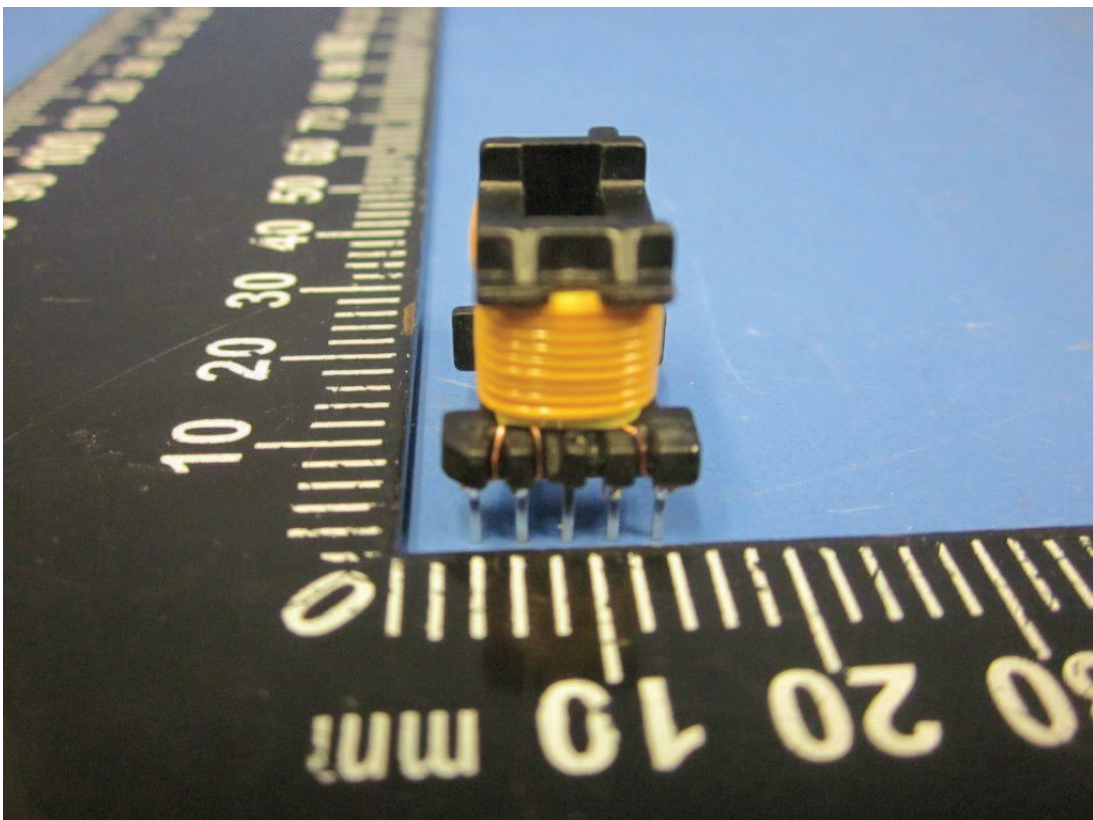

Picture 30

**Model:** GT-86122-WWVV-W2Z (WW, VV, Z are variables)

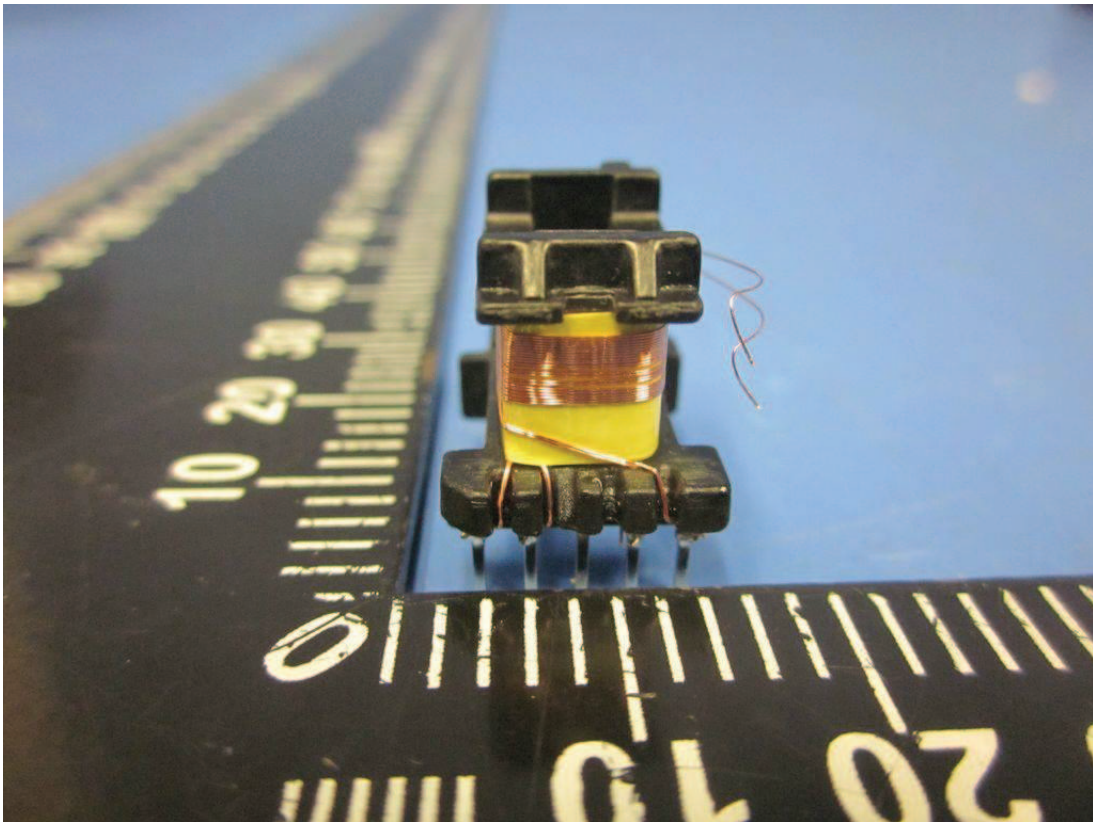

Picture 31

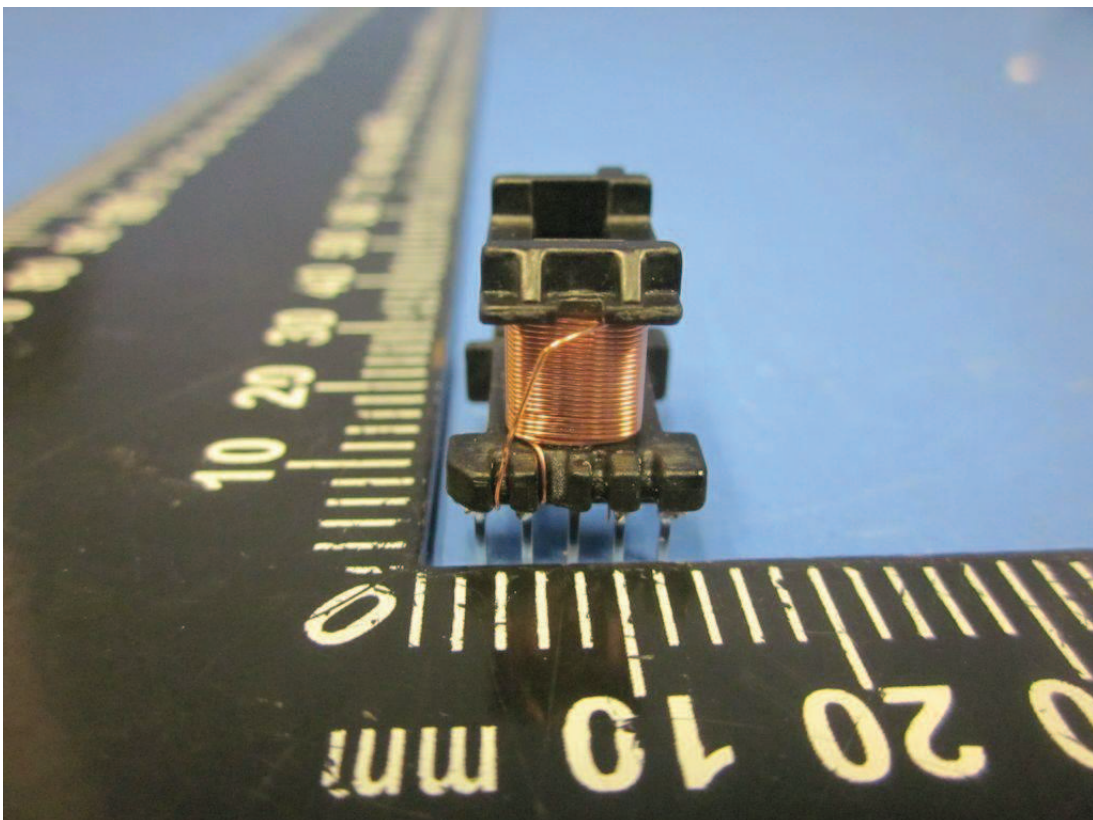

Picture 32



Model: GT-86122-WWVV-W2Z (WW, VV, Z are variables)

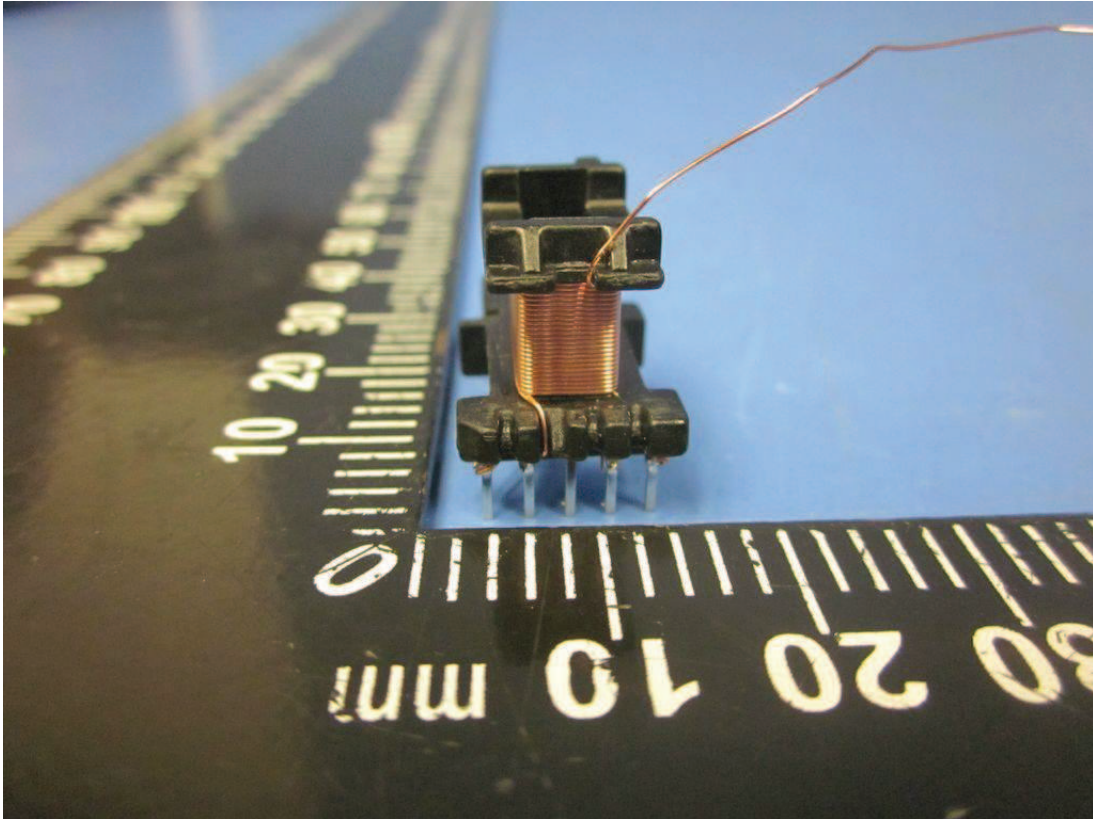

Picture 33

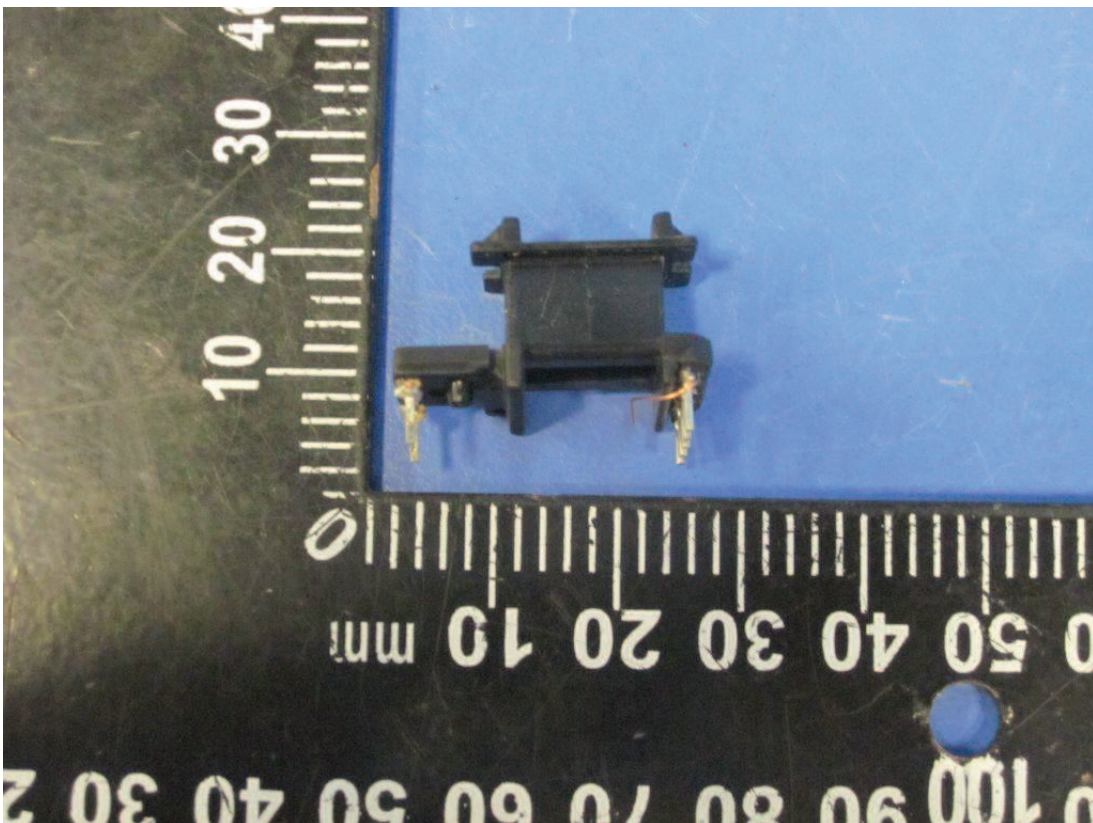

Picture 34