



# CE EMC TEST REPORT

**REPORT NO.:** CE970318A14A

**MODEL NO.:** GT-41131-WWVV-X.X series  
– *multiple listing see item 3.1*

**RECEIVED:** March 18, 2008

**TESTED:** March 21~ 26, 2008

**ISSUED:** July 2, 2010

**APPLICANT:** GlobTek, Inc.

**ADDRESS:** 186 Veterans Dr. Northvale, NJ 07647 USA

**ISSUED BY:** Bureau Veritas Consumer Products Services  
(H.K.) Ltd., Taoyuan Branch

**LAB LOCATION:** No. 47, 14th Ling, Chia Pau Tsuen, Lin Kou  
Hsiang, Taipei Hsien 244, Taiwan

This test report consists of 68 pages in total. It may be duplicated completely for legal use with the approval of the applicant. It should not be reproduced except in full, without the written approval of our laboratory. The client should not use it to claim product certification, approval, or endorsement by TAF, NVLAP, NIST or any government agencies. The test results in the report only apply to the tested sample. The test results in this report are traceable to the national or international standards.



## Table of Contents

1	CERTIFICATION.....	5
2	SUMMARY OF TEST RESULTS.....	7
2.1	MEASUREMENT UNCERTAINTY .....	8
3	GENERAL INFORMATION .....	9
3.1	GENERAL DESCRIPTION OF EUT.....	9
3.2	DESCRIPTION OF TEST MODES.....	10
3.3	GENERAL DESCRIPTION OF APPLIED STANDARDS .....	11
3.4	DESCRIPTION OF SUPPORT UNITS.....	12
3.4.1	FOR EMISSION TEST .....	12
3.4.2	FOR HARMONICS/ FLICKER/ IMMUNITY TEST .....	13
4	EMISSION TEST.....	14
4.1	CONDUCTED EMISSION MEASUREMENT .....	14
4.1.1	LIMITS OF CONDUCTED EMISSION MEASUREMENT.....	14
4.1.2	TEST INSTRUMENTS .....	14
4.1.3	TEST PROCEDURE .....	15
4.1.4	DEVIATION FROM TEST STANDARD .....	15
4.1.5	TEST SETUP .....	15
4.1.6	EUT OPERATING CONDITIONS.....	15
4.1.7	TEST RESULTS (1) .....	16
4.1.8	TEST RESULTS (2) .....	18
4.2	RADIATED EMISSION MEASUREMENT .....	20
4.2.1	LIMITS OF RADIATED EMISSION MEASUREMENT.....	20
4.2.2	TEST INSTRUMENTS .....	20
4.2.3	TEST PROCEDURE .....	21
4.2.4	DEVIATION FROM TEST STANDARD .....	21
4.2.5	TEST SETUP .....	22
4.2.6	EUT OPERATING CONDITIONS.....	22
4.2.7	TEST RESULTS.....	23
4.3	HARMONICS CURRENT MEASUREMENT .....	25
4.3.1	LIMITS OF HARMONICS CURRENT MEASUREMENT.....	25
4.3.2	TEST INSTRUMENTS .....	25
4.3.3	TEST PROCEDURE .....	26
4.3.4	DEVIATION FROM TEST STANDARD .....	26
4.3.5	TEST SETUP .....	27
4.3.6	EUT OPERATING CONDITIONS.....	27
4.3.7	TEST RESULTS.....	28
4.4	VOLTAGE FLUCTUATION AND FLICKS MEASUREMENT .....	29
4.4.1	LIMITS OF VOLTAGE FLUCTUATION AND FLICKS MEASUREMENT .....	29
4.4.2	TEST INSTRUMENTS .....	29
4.4.3	TEST PROCEDURE .....	29
4.4.4	DEVIATION FROM TEST STANDARD .....	29
4.4.5	TEST SETUP .....	30
4.4.6	EUT OPERATING CONDITIONS.....	30
4.4.7	TEST RESULTS.....	31



5	IMMUNITY TEST .....	32
5.1	GENERAL DESCRIPTION.....	32
5.2	GENERAL PERFORMANCE CRITERIA DESCRIPTION .....	33
5.3	EUT OPERATING CONDITION .....	33
5.4	ELECTROSTATIC DISCHARGE IMMUNITY TEST (ESD).....	34
5.4.1	TEST SPECIFICATION .....	34
5.4.2	TEST INSTRUMENTS .....	34
5.4.3	TEST PROCEDURE .....	34
5.4.4	DEVIATION FROM TEST STANDARD .....	35
5.4.5	TEST SETUP .....	36
5.4.6	TEST RESULTS.....	37
5.5	RADIATED, RADIO-FREQUENCY, ELECTROMAGNETIC FIELD IMMUNITY TEST (RS).....	38
5.5.1	TEST SPECIFICATION .....	38
5.5.2	TEST INSTRUMENTS .....	38
5.5.3	TEST PROCEDURE .....	39
5.5.4	DEVIATION FROM TEST STANDARD .....	39
5.5.5	TEST SETUP .....	40
5.5.6	TEST RESULTS.....	41
5.6	ELECTRICAL FAST TRANSIENT/BURST IMMUNITY TEST (EFT) .....	42
5.6.1	TEST SPECIFICATION .....	42
5.6.2	TEST INSTRUMENTS .....	42
5.6.3	TEST PROCEDURE .....	42
5.6.4	DEVIATION FROM TEST STANDARD .....	42
5.6.5	TEST SETUP .....	43
5.6.6	TEST RESULTS.....	44
5.7	SURGE IMMUNITY TEST.....	45
5.7.1	TEST SPECIFICATION .....	45
5.7.2	TEST INSTRUMENTS .....	45
5.7.3	TEST PROCEDURE .....	46
5.7.4	DEVIATION FROM TEST STANDARD .....	46
5.7.5	TEST SETUP .....	47
5.7.6	TEST RESULTS.....	48
5.8	IMMUNITY TO CONDUCTED DISTURBANCES INDUCED BY RF FIELDS (CS).....	49
5.8.1	TEST SPECIFICATION .....	49
5.8.2	TEST INSTRUMENTS .....	49
5.8.3	TEST PROCEDURE .....	50
5.8.4	DEVIATION FROM TEST STANDARD .....	50
5.8.5	TEST SETUP .....	51
5.8.6	TEST RESULTS.....	52
5.9	POWER FREQUENCY MAGNETIC FIELD IMMUNITY TEST.....	53
5.9.1	TEST SPECIFICATION .....	53
5.9.2	TEST INSTRUMENTS .....	53
5.9.3	TEST PROCEDURE .....	53
5.9.4	DEVIATION FROM TEST STANDARD .....	53
5.9.5	TEST SETUP .....	54
5.9.6	TEST RESULTS.....	55



A D T

5.10	VOLTAGE DIP/SHORT INTERRUPTIONS/VOLTAGE VARIATIONS (DIP) IMMUNITY TEST .....	56
5.10.1	TEST SPECIFICATION .....	56
5.10.2	TEST INSTRUMENTS .....	56
5.10.3	TEST PROCEDURE .....	56
5.10.4	DEVIATION FROM TEST STANDARD .....	56
5.10.5	TEST SETUP .....	57
5.10.6	TEST RESULTS.....	58
6	PHOTOGRAPHS OF THE TEST CONFIGURATION.....	59
7	APPENDIX - INFORMATION ON THE TESTING LABORATORIES.....	68



## 1 CERTIFICATION

**PRODUCT:** Switching-Mode Power Supply  
**BRAND NAME:** GlobTek  
**MODEL NO:** GT-41131-WWVV-X.X series – *multiple listing see item 3.1*  
**TEST ITEM:** ENGINEERING SAMPLE  
**APPLICANT:** GlobTek,Inc.  
**TESTED:** March 21~ 26, 2008  
**STANDARDS:** **EN 55022: 2006+A1: 2007, Class B**  
**CISPR 22: 2005+A1: 2005, Class B**  
**AS/NZS CISPR 22: 2006, Class B**  
**EN 61000-3-2: 2006**  
**EN 61000-3-3: 2008**  
**EN 55024: 1998+A1: 2001+A2: 2003**  
IEC 61000-4-2: 2008 ED.2.0  
IEC 61000-4-3: 2006+A1: 2007 ED.3.0  
IEC 61000-4-4: 2004 ED.2.0  
IEC 61000-4-5: 2005 ED.2.0  
IEC 61000-4-6: 2008 ED.3.0  
IEC 61000-4-8: 2009 ED.2.0  
IEC 61000-4-11: 2004 ED.2.0

The above equipment has been tested by **Bureau Veritas Consumer Products Services (H.K.) Ltd., Taoyuan Branch**, and found compliance with the requirement of the above standards.

Approval signature – on next page



**CERTIFICATION - Continued**

The test record, data evaluation & Equipment Under Test (EUT) configurations represented herein are true and accurate accounts of the measurements of the sample's EMC characteristics under the conditions specified in this report.

**PREPARED BY** :  Vivian Chen  , **DATE:**  July 2, 2010   
( Vivian Chen / Specialist )

**TECHNICAL ACCEPTANCE** :  Joyce Chen  , **DATE:**  July 2, 2010   
( Joyce Chen / Senior Engineer )

**APPROVED BY** :  Kenny Meng  , **DATE:**  July 2, 2010   
( Kenny Meng / Assistant Manager )

## 2 SUMMARY OF TEST RESULTS

The EUT has been tested according to the following specifications:

EMISSION			
Standard	Test Type	Result	Remarks
EN 55022: 2006 +A1: 2007, Class B	Conducted Test	PASS	Meets Class B Limit Minimum passing margin is -6.69 dB at 0.189 MHz
CISPR 22: 2005 +A1: 2005, Class B			Meets Class B Limit Minimum passing margin is -6.84 dB at 92.43 MHz
AS/NZS CISPR 22: 2006, Class B	Radiated Test (30MHz ~ 1GHz)	PASS	Meets Class B Limit Minimum passing margin is -6.84 dB at 92.43 MHz
EN 61000-3-2: 2006	Harmonic current emissions	PASS	The power consumption of EUT is less than 75W and no limits apply
EN 61000-3-3: 2008	Voltage fluctuations & flicker	PASS	Meets the requirements.

**Note:** The EUT highest frequency generated below 108MHz and therefore the test frequency range was performed for 30MHz to 1GHz for radiated emission test.



A D T

IMMUNITY (EN 55024: 1998+A1:2001+A2:2003)			
Standard	Test Type	Result	Remarks
IEC 61000-4-2 : 2008 ED.2.0	Electrostatic discharge immunity test	PASS	Meets the requirements of Performance Criterion A
IEC 61000-4-3: 2006 +A1: 2007 ED.3.0	Radiated, radio-frequency, electromagnetic field immunity test	PASS	Meets the requirements of Performance Criterion A
IEC 61000-4-4: 2004 ED.2.0	Electrical fast transient / burst immunity test.	PASS	Meets the requirements of Performance Criterion A
IEC 61000-4-5: 2005 ED.2.0	Surge immunity test	PASS	Meets the requirements of Performance Criterion A
IEC 61000-4-6: 2008 ED.3.0	Immunity to conducted disturbances, induced by radio-frequency fields	PASS	Meets the requirements of Performance Criterion A
IEC 61000-4-8: 2009 ED.2.0	Power frequency magnetic field immunity test.	PASS	Meets the requirements of Performance Criterion A
IEC 61000-4-11: 2004 ED.2.0	Voltage dips, short interruptions and voltage variations immunity tests	PASS	Meets the requirements of <b>Voltage Dips:</b> i) >95% reduction - Performance Criterion A ii) 30% reduction – Performance Criterion A <b>Voltage Interruptions:</b> i) >95% reduction – Performance Criterion B

## 2.1 MEASUREMENT UNCERTAINTY

Where relevant, the following measurement uncertainty levels have been estimated for tests performed on the EUT as specified in CISPR 16-4-2:

"This uncertainty represents an expanded uncertainty expressed at approximately the 95% confidence level using a coverage factor of k=2."

MEASUREMENT	UNCERTAINTY
Conducted emissions	2.45 dB
Radiated emissions	3.97 dB



### 3 GENERAL INFORMATION

#### 3.1 GENERAL DESCRIPTION OF EUT

<b>PRODUCT</b>	Switching-Mode Power Supply
<b>MODEL NO.</b>	GT-41131-WWVV-X.X series - <i>multiple listing as below</i>
<b>POWER SUPPLY</b>	Switching AC I/P: 100-240V, 1A, 50-60Hz Power cord: AC 2-Pin Non-shielded DC cable (1.8 m)
<b>DATA CABLE SUPPLIED</b>	N/A

#### NOTE:

- The EUT is a Switching-Mode Power Supply and the definition of model number is as the following:
  - ◆ WW is the rated output wattage designation, with a maximum value of "30";
  - ◆ VV is the standard rated output voltage designation, with a maximum value of "48";
  - ◆ -X.X is optional or blank and denotes the output voltage differentiator, subtracting or adding X.X volts from standard output voltage VV in 0.1V increments

- The following models were selected for testing:

Model No.	DC O/P
GT-41131-3024	24V, 1.25A
GT-41131-3048	48V, 0.625A

- The EUT has seven plug types as follows:
  - ◆ USA
  - ◆ Australia
  - ◆ England
  - ◆ EU
  - ◆ Argentina
  - ◆ Korea
  - ◆ China
- For a more detailed features description, please refer to the manufacturer's specifications or the User's Manual.

### 3.2 DESCRIPTION OF TEST MODES

During the test, the above models were pre-test, and the worse emission levels were selected and tested under the following modes, as below:

Test Item	Test Mode	Description of Test Mode	
		Model No.	Test Condition
Conducted Test	Mode 1	GT-41131-3024	Full load
	Mode 2	GT-41131-3048	
Radiated, Harmonic, Flicker & Immunity Tests	Mode 2	GT-41131-3048	

All above test modes were recorded in this report.

### 3.3 GENERAL DESCRIPTION OF APPLIED STANDARDS

The EUT is a kind of ITE equipment and, according to the specifications of the manufacturers, must comply with the requirements of the following standards:

**EN 55022: 2006+A1: 2007, Class B**

**CISPR 22: 2005+A1: 2005, Class B**

**AS/NZS CISPR 22: 2006, Class B**

**EN 61000-3-2: 2006**

**EN 61000-3-3: 2008**

**EN 55024: 1998+A1: 2001+A2: 2003**

IEC 61000-4-2: 2008 ED.2.0

IEC 61000-4-3: 2006+A1: 2007 ED.3.0

IEC 61000-4-4: 2004 ED.2.0

IEC 61000-4-5: 2005 ED.2.0

IEC 61000-4-6: 2008 ED.3.0

IEC 61000-4-8: 2009 ED.2.0

IEC 61000-4-11: 2004 ED.2.0

**Notes:** The above IEC basic standards are applied with latest version if customer has no special requirement

### 3.4 DESCRIPTION OF SUPPORT UNITS

The EUT has been tested as an independent unit together with other necessary accessories or support units. The following support units or accessories were used to form a representative test configuration during the tests.

#### 3.4.1 FOR EMISSION TEST

NO.	PRODUCT	BRAND	MODEL NO.	SERIAL NO.	FCC ID
1	DUMMY LOAD	ADT	L19A	L2-010011	N/A
2	DUMMY LOAD	ADT	L19A	L2-010007	N/A

**NOTE:** All power cords of the above support units are non-shielded (1.8 m).

#### TEST CONFIGURATION

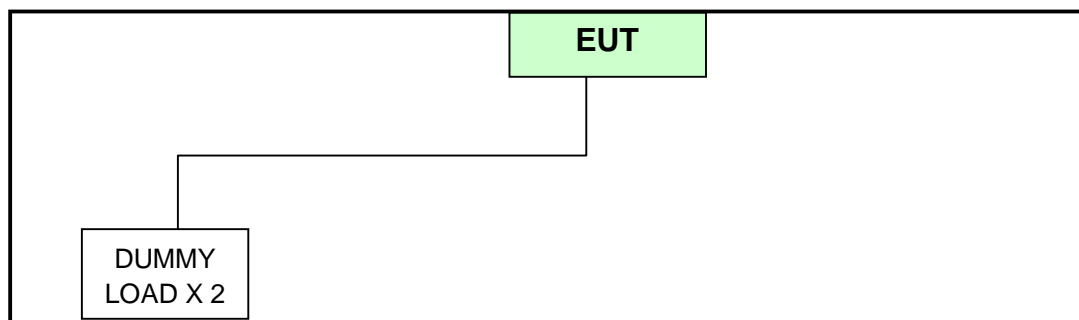

### 3.4.2 FOR HARMONICS/ FLICKER/ IMMUNITY TEST

NO.	PRODUCT	BRAND	MODEL NO.	SERIAL NO.	FCC ID
1	DUMMY LOAD	ADT	L19A	L2-010005	N/A
2	Multimeter <For Immunity Test only>	YFE	YF-370A	N/A	N/A

**NOTE:** All power cords of the above support units are non-shielded (1.8 m).

#### TEST CONFIGURATION – For Harmonics/ Flicker Test

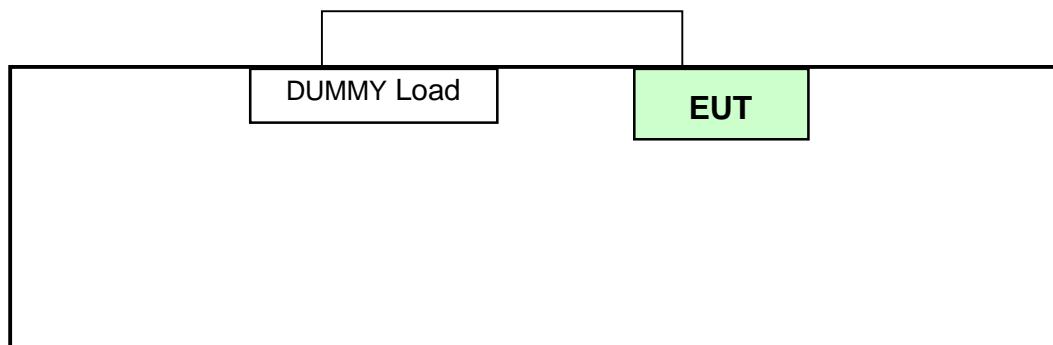

#### TEST CONFIGURATION – For Immunity Test

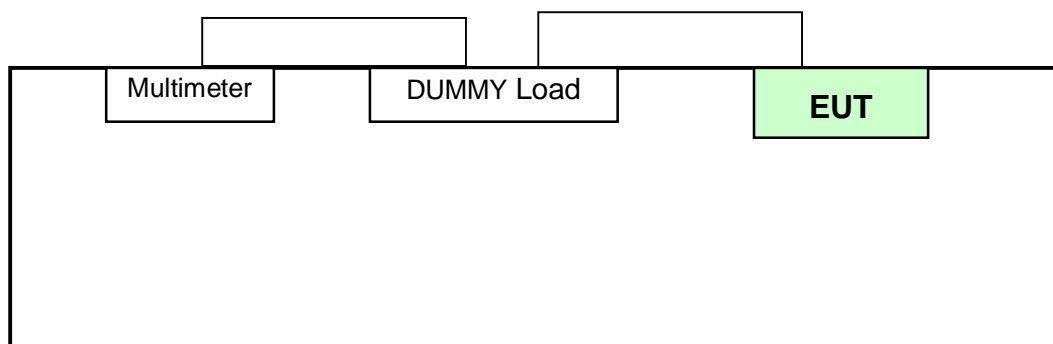

## 4 EMISSION TEST

### 4.1 CONDUCTED EMISSION MEASUREMENT

#### 4.1.1 LIMITS OF CONDUCTED EMISSION MEASUREMENT

TEST STANDARD: EN 55022

FREQUENCY (MHz)	Class A (dBuV)		Class B (dBuV)	
	Quasi-peak	Average	Quasi-peak	Average
0.15 - 0.5	79	66	66 - 56	56 - 46
0.50 - 5.0	73	60	56	46
5.0 - 30.0	73	60	60	50

- NOTE:**
- (1) The lower limit shall apply at the transition frequencies.
  - (2) The limit decreases in line with the logarithm of the frequency in the range of 0.15 to 0.50 MHz.
  - (3) All emanations from a class A/B digital device or system, including any network of conductors and apparatus connected thereto, shall not exceed the level of field strengths specified above.

#### 4.1.2 TEST INSTRUMENTS

DESCRIPTION & MANUFACTURER	MODEL NO.	SERIAL NO.	CALIBRATED UNTIL
ROHDE & SCHWARZ Test Receiver	ESHS 30	828765/002	Jul. 30, 2008
ROHDE & SCHWARZ Artificial Mains Network (for EUT)	ESH3-Z5	835239/001	Feb. 26, 2009
LISN With Adapter (for EUT)	AD10	C09Ada-001	Feb. 26, 2009
ROHDE & SCHWARZ Artificial Mains Network (for peripherals)	ESH3-Z5	835239/002	Mar. 12, 2009
Software	ADT_Cond_V7.3.5	NA	NA
Software	ADT_ISN_V7.3.5	NA	NA
RF cable (JYEBAO)	5D-FB	Cable-C09.01	Feb. 26, 2009
SUHNTER Terminator (For ROHDE & SCHWARZ LISN)	65BNC-5001	E1-010789	May 17, 2008

- NOTE:**
1. The calibration interval of the above test instruments is 12 months and the calibrations are traceable to NML/ROC and NIST/USA.
  2. The test was performed in ADT Shielded Room No. 9.
  3. The VCCI Site Registration No. C-1312.

### 4.1.3 TEST PROCEDURE

- a. The EUT was placed 0.4 meters from the conducting wall of the shielded room with EUT being connected to the power mains through a line impedance stabilization network (LISN). Other support units were connected to the power mains through another LISN. The two LISNs provide 50 Ohm/ 50uH of coupling impedance for the measuring instrument.
- b. Both lines of the power mains connected to the EUT were checked for maximum conducted interference.
- c. The frequency range from 150 kHz to 30 MHz was searched. Emission levels under (Limit - 20dB) were not recorded.

### 4.1.4 DEVIATION FROM TEST STANDARD

No deviation

### 4.1.5 TEST SETUP

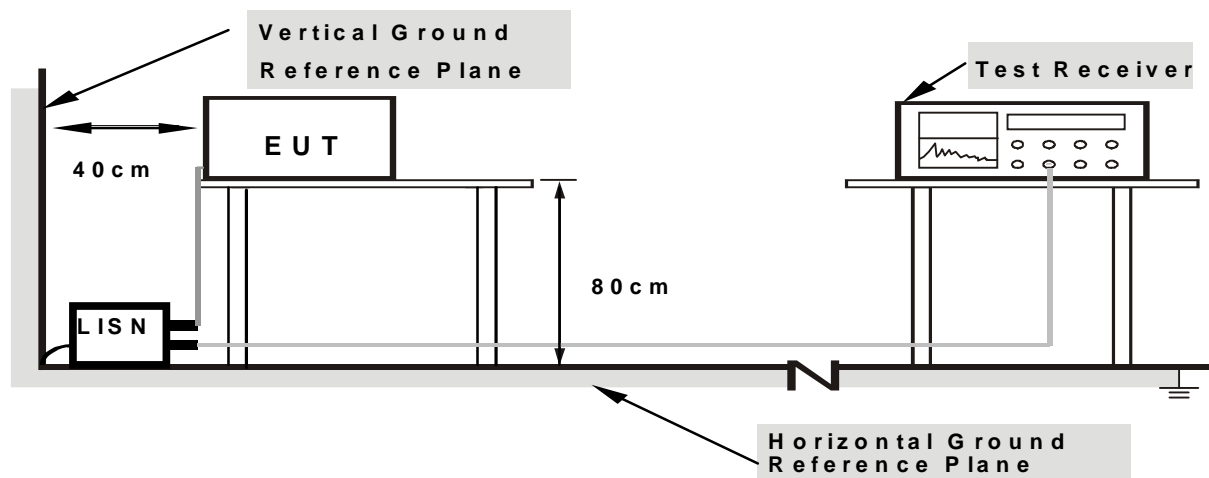

- Note:**
1. Support units were connected to second LISN.
  2. Both of LISNs (AMN) are 80 cm from EUT and at least 80 cm from other units and other metal planes

For the actual test configuration, please refer to the related item – Photographs of the Test Configuration.

### 4.1.6 EUT OPERATING CONDITIONS

Set the EUT under full resistor load.



A D T

### 4.1.7 TEST RESULTS (1)

<b>TEST MODE</b>	Mode 1	<b>6dB BANDWIDTH</b>	9 kHz
<b>INPUT POWER</b>	230 Vac, 50 Hz	<b>PHASE</b>	Line (L)
<b>ENVIRONMENTAL CONDITIONS</b>	23 deg. C, 68% RH, 1002 hPa	<b>TESTED BY:</b> Jerry Huang	

No	Freq. [MHz]	Corr. Factor (dB)	Reading Value		Emission Level		Limit		Margin	
			[dB (uV)]		[dB (uV)]		[dB (uV)]		(dB)	
			Q.P.	AV.	Q.P.	AV.	Q.P.	AV.	Q.P.	AV.
1	0.184	0.19	56.87	42.39	57.06	42.58	64.29	54.29	-7.23	-11.71
2	0.247	0.19	49.84	-	50.03	-	61.86	51.86	-11.83	-
3	0.312	0.20	43.10	-	43.30	-	59.92	49.92	-16.62	-
4	0.428	0.20	37.42	-	37.62	-	57.29	47.29	-19.67	-
5	0.607	0.21	34.17	-	34.38	-	56.00	46.00	-21.62	-
6	4.210	0.44	33.87	-	34.31	-	56.00	46.00	-21.69	-
7	17.276	1.15	29.85	-	31.00	-	60.00	50.00	-29.00	-

- REMARKS:**
1. Q.P. and AV. are abbreviations of quasi-peak and average individually.
  2. "-": The Quasi-peak reading value also meets average limit and measurement with the average detector is unnecessary.
  3. The emission levels of other frequencies were very low against the limit.
  4. Margin value = Emission level - Limit value
  5. Correction factor = Insertion loss + Cable loss
  6. Emission Level = Correction Factor + Reading Value.

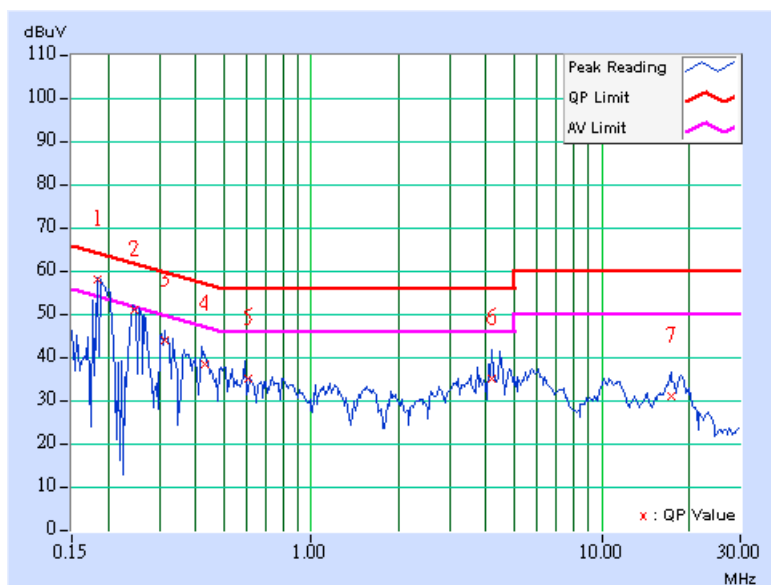





A D T

<b>TEST MODE</b>	Mode 1	<b>6dB BANDWIDTH</b>	9 kHz
<b>INPUT POWER</b>	230 Vac, 50 Hz	<b>PHASE</b>	Neutral (N)
<b>ENVIRONMENTAL CONDITIONS</b>	23 deg. C, 68% RH, 1002 hPa	<b>TESTED BY:</b> Jerry Huang	

No	Freq. [MHz]	Corr. Factor (dB)	Reading Value		Emission Level		Limit		Margin	
			[dB (uV)]		[dB (uV)]		[dB (uV)]		(dB)	
			Q.P.	AV.	Q.P.	AV.	Q.P.	AV.	Q.P.	AV.
1	0.189	0.19	57.20	44.12	57.39	44.31	64.08	54.08	-6.69	-9.77
2	0.246	0.19	50.97	-	51.16	-	61.89	51.89	-10.73	-
3	0.303	0.20	44.76	-	44.96	-	60.16	50.16	-15.21	-
4	0.450	0.20	36.04	-	36.24	-	56.88	46.88	-20.64	-
5	0.548	0.20	37.93	-	38.13	-	56.00	46.00	-17.87	-
6	1.630	0.25	36.43	-	36.68	-	56.00	46.00	-19.32	-
7	4.542	0.46	39.30	-	39.76	-	56.00	46.00	-16.24	-
8	5.264	0.49	36.33	-	36.82	-	60.00	50.00	-23.18	-

- REMARKS:**
1. Q.P. and AV. are abbreviations of quasi-peak and average individually.
  2. "-": The Quasi-peak reading value also meets average limit and measurement with the average detector is unnecessary.
  3. The emission levels of other frequencies were very low against the limit.
  4. Margin value = Emission level - Limit value
  5. Correction factor = Insertion loss + Cable loss
  6. Emission Level = Correction Factor + Reading Value.

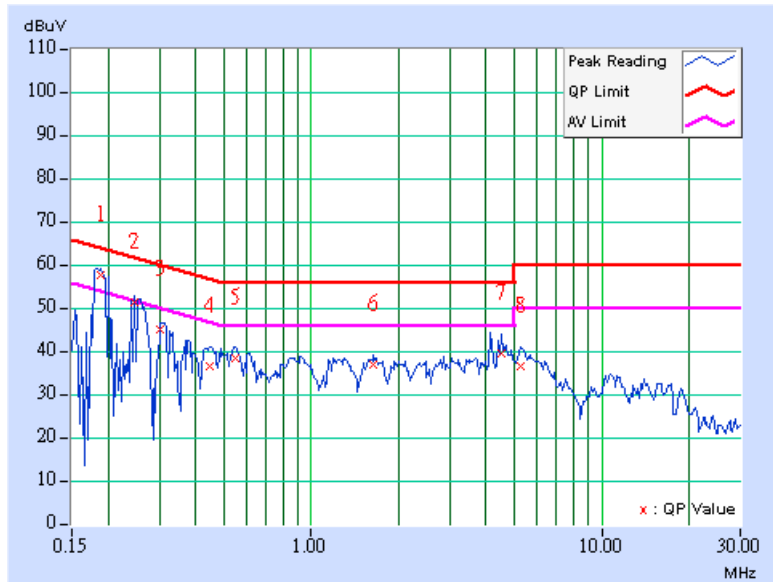



A D T

### 4.1.8 TEST RESULTS (2)

<b>TEST MODE</b>	Mode 2	<b>6dB BANDWIDTH</b>	9 kHz
<b>INPUT POWER</b>	230 Vac, 50 Hz	<b>PHASE</b>	Line (L)
<b>ENVIRONMENTAL CONDITIONS</b>	23 deg. C, 68% RH, 1002 hPa	<b>TESTED BY:</b> Jerry Huang	

No	Freq. [MHz]	Corr. Factor (dB)	Reading Value		Emission Level		Limit		Margin	
			[dB (uV)]		[dB (uV)]		[dB (uV)]		(dB)	
			Q.P.	AV.	Q.P.	AV.	Q.P.	AV.	Q.P.	AV.
1	0.171	0.19	56.22	44.86	56.41	45.05	64.91	54.91	-8.50	-9.86
2	0.228	0.19	49.88	-	50.07	-	62.52	52.52	-12.45	-
3	0.285	0.19	44.18	-	44.37	-	60.67	50.67	-16.29	-
4	0.405	0.20	38.18	-	38.38	-	57.75	47.75	-19.37	-
5	0.561	0.21	34.43	-	34.64	-	56.00	46.00	-21.36	-
6	4.480	0.45	39.29	-	39.74	-	56.00	46.00	-16.26	-
7	5.304	0.49	43.48	-	43.97	-	60.00	50.00	-16.03	-

- REMARKS:**
1. Q.P. and AV. are abbreviations of quasi-peak and average individually.
  2. "-": The Quasi-peak reading value also meets average limit and measurement with the average detector is unnecessary.
  3. The emission levels of other frequencies were very low against the limit.
  4. Margin value = Emission level - Limit value
  5. Correction factor = Insertion loss + Cable loss
  6. Emission Level = Correction Factor + Reading Value.

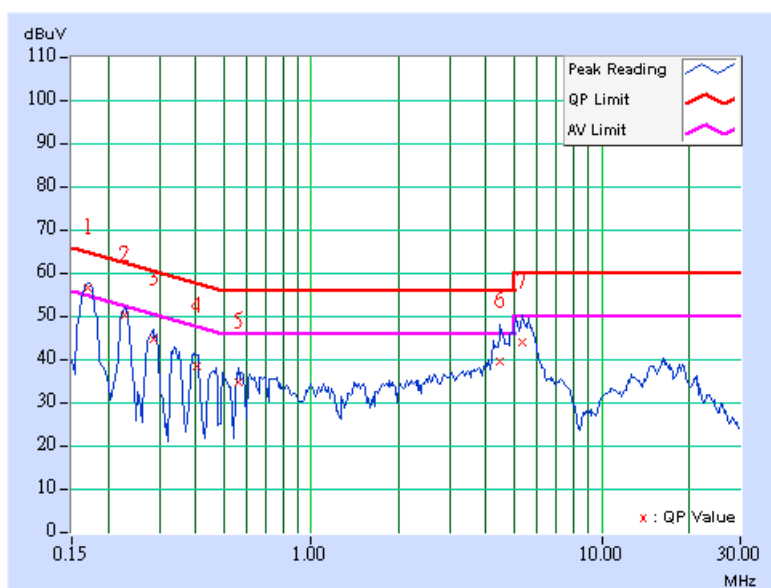



A D T

<b>TEST MODE</b>	Mode 2	<b>6dB BANDWIDTH</b>	9 kHz
<b>INPUT POWER</b>	230 Vac, 50 Hz	<b>PHASE</b>	Neutral (N)
<b>ENVIRONMENTAL CONDITIONS</b>	23 deg. C, 68% RH, 1002 hPa	<b>TESTED BY:</b> Jerry Huang	

No	Freq. [MHz]	Corr. Factor (dB)	Reading Value		Emission Level		Limit		Margin	
			[dB (uV)]		[dB (uV)]		[dB (uV)]		(dB)	
			Q.P.	AV.	Q.P.	AV.	Q.P.	AV.	Q.P.	AV.
1	0.173	0.19	55.58	44.30	55.77	44.49	64.81	54.81	-9.04	-10.32
2	0.231	0.19	49.26	-	49.45	-	62.41	52.41	-12.96	-
3	0.351	0.20	40.75	-	40.95	-	58.94	48.94	-17.99	-
4	0.507	0.20	40.28	-	40.48	-	56.00	46.00	-15.52	-
5	1.984	0.26	35.70	-	35.96	-	56.00	46.00	-20.04	-
6	4.648	0.47	41.40	-	41.87	-	56.00	46.00	-14.13	-
7	5.140	0.49	43.12	-	43.61	-	60.00	50.00	-16.39	-

- REMARKS:**
1. Q.P. and AV. are abbreviations of quasi-peak and average individually.
  2. "-": The Quasi-peak reading value also meets average limit and measurement with the average detector is unnecessary.
  3. The emission levels of other frequencies were very low against the limit.
  4. Margin value = Emission level - Limit value
  5. Correction factor = Insertion loss + Cable loss
  6. Emission Level = Correction Factor + Reading Value.

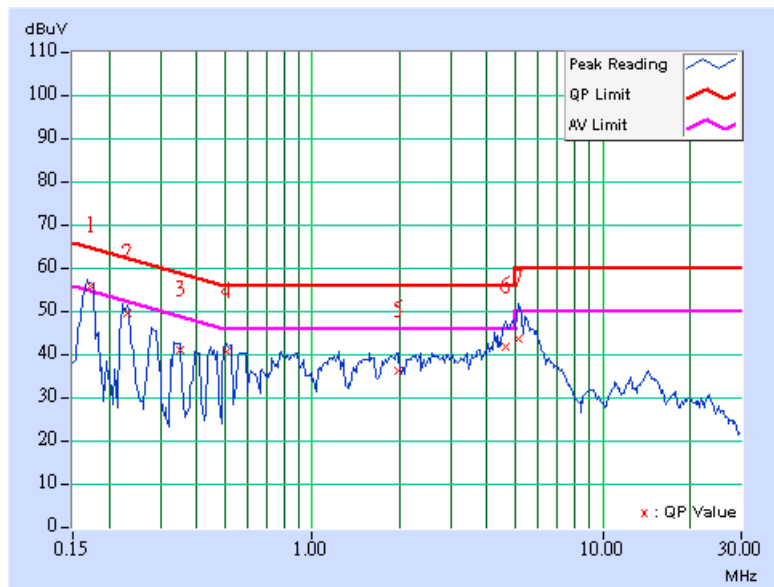

## 4.2 RADIATED EMISSION MEASUREMENT

### 4.2.1 LIMITS OF RADIATED EMISSION MEASUREMENT

TEST STANDARD: EN 55022

FREQUENCY (MHz)	Class A (at 10m)	Class B (at 10m)
	dBuV/m	dBuV/m
30 – 230	40	30
230 - 1000	47	37

- NOTE:**
- (1) The lower limit shall apply at the transition frequencies.
  - (2) Emission level (dBuV/m) = 20 log Emission level (uV/m).
  - (3) All emanations from a class A/B digital device or system, including any network of conductors and apparatus connected thereto, shall not exceed the level of field strengths specified above.

### 4.2.2 TEST INSTRUMENTS

DESCRIPTION & MANUFACTURER	MODEL NO.	SERIAL NO.	CALIBRATED UNTIL
ROHDE & SCHWARZ TEST RECEIVER	ESVS10	846285/012	Aug. 06, 2008
CHASE BILOG Antenna	CBL6112A	2331	Sep. 13, 2008
ADT. Turn Table	TT100	0201	NA
ADT. Tower	AT100	0201	NA
Software	ADT_Radiate d_V7.6.15	NA	NA
ANRITSU RF Switches	MP59B	M32159	Mar. 29, 2008
WOKEN RF cable	8D	CABLE-ST8-01	Mar. 29, 2008

- NOTE:**
1. The calibration interval of the above test instruments is 12 months. And the calibrations are traceable to NML/ROC and NIST/USA.
  2. The test was performed in ADT Open Site No. 8.
  3. The VCCI Site Registration No. R-877.

### 4.2.3 TEST PROCEDURE

- a. The EUT was placed on the top of a rotating table 0.8 meters above the ground at a 10-meter open field site. The table was rotated 360 degrees to determine the position of the highest radiation.
- b. The EUT was set 10 meters away from the interference-receiving antenna, which was mounted on the top of a variable-height antenna tower.
- c. The antenna is a broadband antenna, and its height is varied from one meter to four meters above the ground to determine the maximum value of the field strength. Both horizontal and vertical polarizations of the antenna are set to make the measurement.
- d. For each suspected emission, the EUT was arranged to its worst case and then the antenna was tuned to heights from 1 meter to 4 meters and the turn table was turned from 0 degrees to 360 degrees to find the maximum reading.
- e. The test-receiver system was set to Peak Detect Function and Specified Bandwidth with Maximum Hold Mode.

**NOTE:** The resolution bandwidth of test receiver/spectrum analyzer is 120kHz for Quasi-peak detection (QP) at frequency below 1GHz.

### 4.2.4 DEVIATION FROM TEST STANDARD

No deviation

## 4.2.5 TEST SETUP

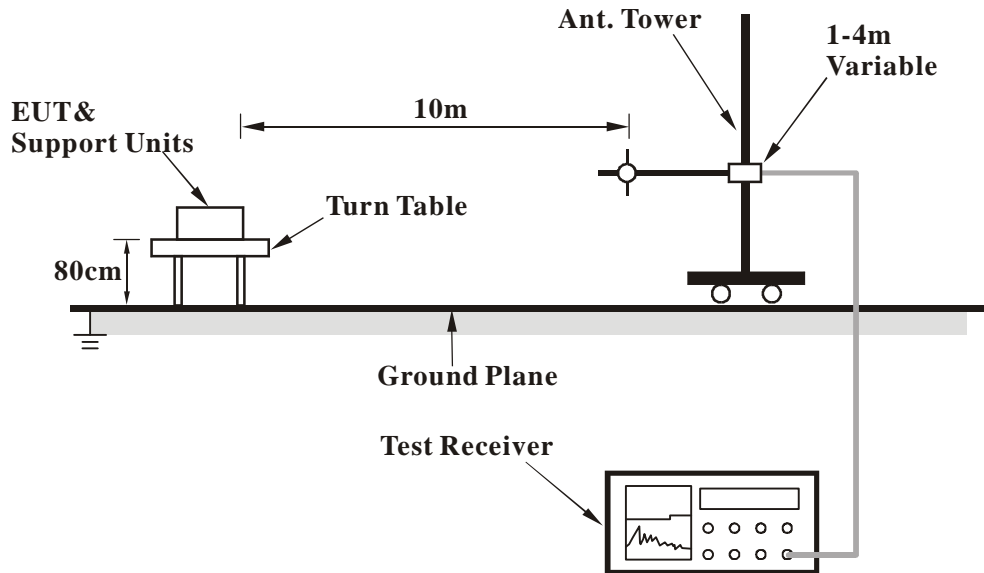

For the actual test configuration, please refer to the related item – Photographs of the Test Configuration.

## 4.2.6 EUT OPERATING CONDITIONS

Same as item 4.1.6

## 4.2.7 TEST RESULTS

<b>TEST MODE</b>	Mode 2	<b>FREQUENCY RANGE</b>	30 ~ 1000 MHz
<b>INPUT POWER</b>	230 Vac, 50 Hz	<b>DETECTOR FUNCTION &amp; BANDWIDTH</b>	Quasi-Peak, 120 kHz
<b>ENVIRONMENTAL CONDITIONS</b>	22 deg. C, 75% RH, 1002 hPa	<b>TESTED BY:</b> Jerry Huang	

### ANTENNA POLARITY & TEST DISTANCE: HORIZONTAL AT 10 M

No.	Freq. (MHz)	Emission Level (dBuV/m)	Limit (dBuV/m)	Margin (dB)	Antenna Height (m)	Table Angle (Degree)	Raw Value (dBuV)	Correction Factor (dB/m)
1	55.15	17.64 QP	30.00	-12.36	4.00 H	73	9.10	8.54
2	92.37	22.52 QP	30.00	-7.48	4.00 H	251	12.99	9.53
3	109.34	19.97 QP	30.00	-10.03	4.00 H	176	7.73	12.24
4	145.45	17.22 QP	30.00	-12.78	4.00 H	49	4.87	12.35
5	188.39	15.69 QP	30.00	-14.31	4.00 H	192	5.19	10.50
6	225.76	15.98 QP	30.00	-14.02	4.00 H	341	3.06	12.92

- REMARKS:**
1. Emission level(dBuV/m)=Raw Value(dBuV) + Correction Factor(dB/m)
  2. Correction Factor(dB/m) = Antenna Factor (dB/m) + Cable Factor (dB)
  3. The other emission levels were very low against the limit.
  4. Margin value = Emission level – Limit value.

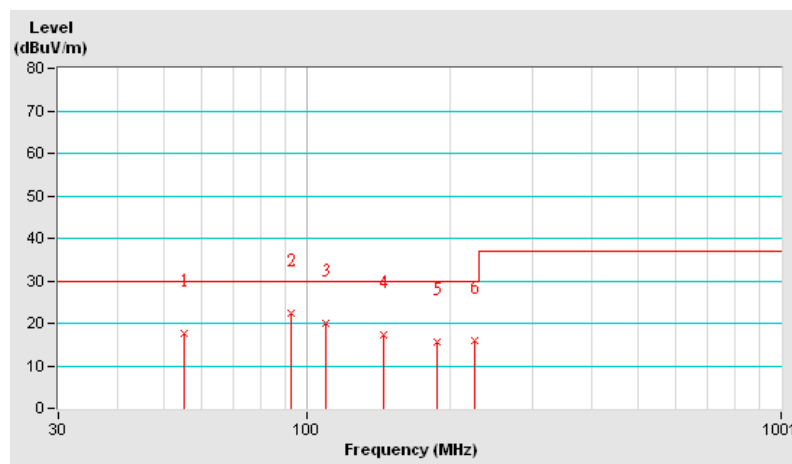



A D T

<b>TEST MODE</b>	Mode 2	<b>FREQUENCY RANGE</b>	30 ~ 1000 MHz
<b>INPUT POWER</b>	230 Vac, 50 Hz	<b>DETECTOR FUNCTION &amp; BANDWIDTH</b>	Quasi-Peak, 120 kHz
<b>ENVIRONMENTAL CONDITIONS</b>	22 deg. C, 75% RH, 1002 hPa	<b>TESTED BY:</b> Jerry Huang	

**ANTENNA POLARITY & TEST DISTANCE: VERTICAL AT 10 M**

No.	Freq. (MHz)	Emission Level (dBuV/m)	Limit (dBuV/m)	Margin (dB)	Antenna Height (m)	Table Angle (Degree)	Raw Value (dBuV)	Correction Factor (dB/m)
1	31.95	18.96 QP	30.00	-11.04	1.98 V	166	-0.25	19.21
2	58.08	20.31 QP	30.00	-9.69	1.68 V	129	13.82	6.49
3	86.44	19.09 QP	30.00	-10.91	1.46 V	324	10.49	8.60
<b>4</b>	<b>92.43</b>	<b>23.16 QP</b>	<b>30.00</b>	<b>-6.84</b>	<b>1.00 V</b>	<b>243</b>	<b>13.61</b>	<b>9.55</b>
5	146.10	21.37 QP	30.00	-8.63	1.00 V	16	9.08	12.29
6	174.56	19.26 QP	30.00	-10.74	1.00 V	162	8.54	10.72

- REMARKS:**
1. Emission level(dBuV/m)=Raw Value(dBuV) + Correction Factor(dB/m)
  2. Correction Factor(dB/m) = Antenna Factor (dB/m) + Cable Factor (dB)
  3. The other emission levels were very low against the limit.
  4. Margin value = Emission level – Limit value.

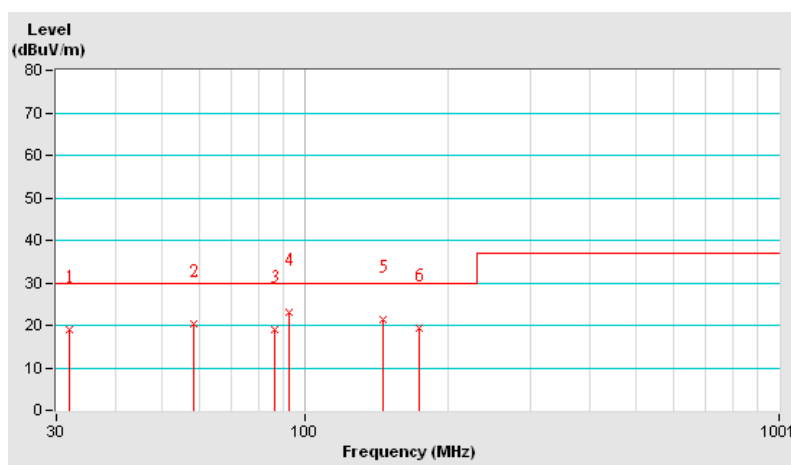



## 4.3 HARMONICS CURRENT MEASUREMENT

### 4.3.1 LIMITS OF HARMONICS CURRENT MEASUREMENT

#### TEST STANDARD: EN 61000-3-2

Limits for Class A equipment	
Harmonics Order n	Max. permissible harmonics current A
odd harmonics	
3	2.30
5	1.14
7	0.77
9	0.40
11	0.33
13	0.21
15<=n<=39	0.15x15/n
Even harmonics	
2	1.08
4	0.43
6	0.30
8<=n<=40	0.23x8/n

Limits for Class D equipment		
Harmonics Order n	Max. permissible harmonics current per watt mA/W	Max. permissible harmonics current A
Odd Harmonics only		
3	3.4	2.30
5	1.9	1.14
7	1.0	0.77
9	0.5	0.40
11	0.35	0.33
13	0.30	0.21
15<=n<=39	3.85/n	0.15x15/n

- NOTE:** 1. Class A and Class D are classified according to section 5 of EN 61000-3-2:2006.
2. According to section 7 of EN 61000-3-2: 2006, the above limits for all equipment except for lighting equipment are for all applications having an active input power > 75 W and no limits apply for equipment with an active input power up to and including 75 W.

### 4.3.2 TEST INSTRUMENTS

DESCRIPTION & MANUFACTURER	MODEL NO.	SERIAL NO.	CALIBRATED UNTIL
EMC PARTNER EMC Emission Tester	HAR1000-1P	084	Apr. 25, 2008
Software	HARCS	NA	NA

- NOTE:** 1. The test was performed in EMS Room No. 1.
2. The calibration interval of the above test instruments is 12 months and the calibrations are traceable to NML/ROC and NIST/USA.

### 4.3.3 TEST PROCEDURE

- a. The EUT was placed on the top of a wooden table 0.8 meters above the ground and operated to produce the maximum harmonic components under normal operating conditions for each successive harmonic component in turn.
- b. The classification of EUT is according to section 5 of EN 61000-3-2:2006.

The EUT is classified as follows:

Class A: Balanced three-phase equipment, Household appliances excluding equipment as Class D, Tools excluding portable tools, Dimmers for incandescent lamps, audio equipment, equipment not specified in one of the three other classes.

Class B: Portable tools; Arc welding equipment which is not professional equipment

Class C: Lighting equipment.

Class D: Equipment having a specified power less than or equal to 600 W of the following types: Personal computers and personal computer monitors and television receivers.

- c. The correspondent test program of test instrument to measure the current harmonics emanated from EUT is chosen. The measure time shall be not less than the time necessary for the EUT to be exercised.

### 4.3.4 DEVIATION FROM TEST STANDARD

No deviation

### 4.3.5 TEST SETUP

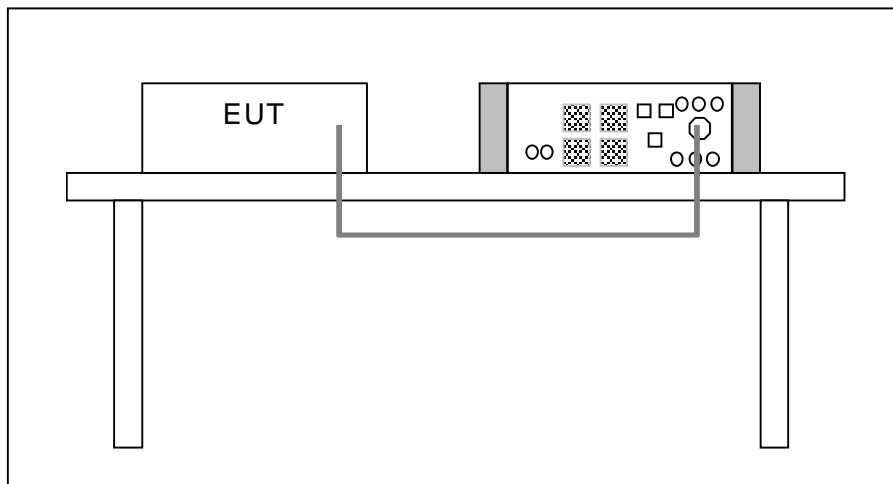

For the actual test configuration, please refer to the related item – Photographs of the Test Configuration.

### 4.3.6 EUT OPERATING CONDITIONS

Connected a resistor load to DC output port of EUT to make EUT have maximum power consumption.

### 4.3.7 TEST RESULTS

<b>TEST MODE</b>	Mode 2		
<b>FUNDAMENTAL VOLTAGE/AMPERE</b>	230.3 Vrms/ 0.316 Arms	<b>POWER FREQUENCY</b>	49.987 Hz
<b>POWER CONSUMPTION</b>	31.013 W	<b>POWER FACTOR</b>	0.425
<b>ENVIRONMENTAL CONDITIONS</b>	21 deg. C, 61% RH, 1003 hPa	<b>TESTED BY:</b> Andy Chang	

**NOTE:** Limits are not specified for equipment with a rated power of 75W or less other than lighting equipment).



A D T

## 4.4 VOLTAGE FLUCTUATION AND FLICKS MEASUREMENT

### 4.4.1 LIMITS OF VOLTAGE FLUCTUATION AND FLICKS MEASUREMENT

TEST STANDARD: EN 61000-3-3

TEST ITEM	LIMIT	NOTE
P <sub>st</sub>	1.0	P <sub>st</sub> means short-term flicker indicator.
P <sub>lt</sub>	0.65	P <sub>lt</sub> means long-term flicker indicator.
d(t) (%)	3.3%	d(t) means maximum time that not exceeds 500 ms.
d <sub>max</sub> (%)	4%	d <sub>max</sub> means maximum relative voltage change.
dc (%)	3.3%	dc means relative steady-state voltage change

### 4.4.2 TEST INSTRUMENTS

DESCRIPTION & MANUFACTURER	MODEL NO.	SERIAL NO.	CALIBRATED UNTIL
EMC PARTNER EMC Emission Tester	HAR1000-1P	084	Apr. 25, 2008
Software	HARCS	NA	NA

- NOTE:** 1. The test was performed in EMS Room No. 1.  
2. The calibration interval of the above test instruments is 12 months and the calibrations are traceable to NML/ROC and NIST/USA.

### 4.4.3 TEST PROCEDURE

- a. The EUT was placed on the top of a wooden table 0.8 meters above the ground and operated to produce the most unfavorable sequence of voltage changes under normal operating conditions.
- b. During the flick measurement, the measure time shall include that part of whole operation cycle in which the EUT produce the most unfavorable sequence of voltage changes. The observation period for short-term flicker indicator is 10 minutes and the observation period for long-term flicker indicator is 2 hours.

### 4.4.4 DEVIATION FROM TEST STANDARD

No deviation

#### 4.4.5 TEST SETUP

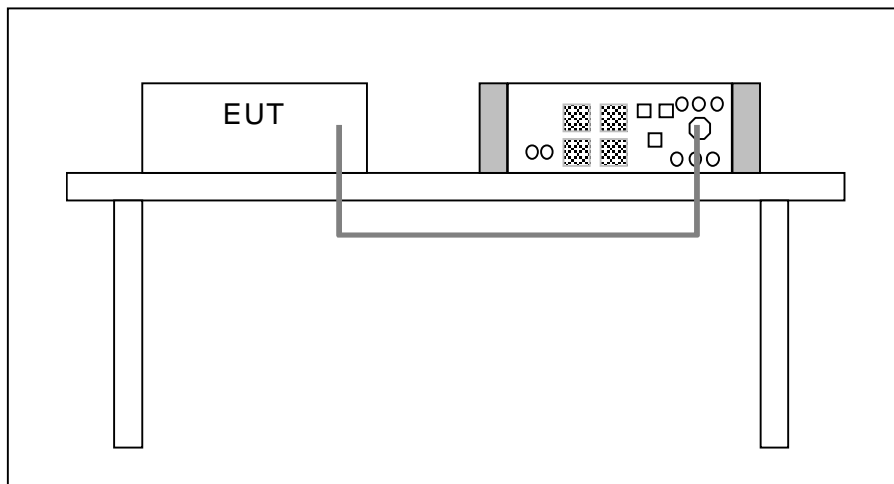

For the actual test configuration, please refer to the related item – Photographs of the Test Configuration.

#### 4.4.6 EUT OPERATING CONDITIONS

Same as item 4.3.6.



A D T

#### 4.4.7 TEST RESULTS

<b>TEST MODE</b>	Mode 2		
<b>FUNDAMENTAL VOLTAGE/AMPERE</b>	230.1 Vrms / 0.308 Arms	<b>POWER FREQUENCY</b>	49.987 Hz
<b>OBSERVATION PERIOD (Tp)</b>	10 minutes	<b>POWER FACTOR</b>	0.438
<b>ENVIRONMENTAL CONDITIONS</b>	21 deg. C, 61% RH, 1003 hPa	<b>TESTED BY:</b> Andy Chang	

TEST PARAMETER	MEASUREMENT VALUE	LIMIT	REMARKS
P <sub>st</sub>	0.072	1.0	Pass
P <sub>lt</sub>	0.072	0.65	Pass
d(t) (%)	0	3.3%	Pass
d <sub>max</sub> (%)	0	4%	Pass
dc (%)	0.010	3.3%	Pass

- NOTE:**
- (1) P<sub>st</sub> means short-term flicker indicator.
  - (2) P<sub>lt</sub> means long-term flicker indicator.
  - (3) d(t) means maximum time that not exceeds 500 ms.
  - (4) d<sub>max</sub> means maximum relative voltage change.
  - (5) dc means relative steady-state voltage change.

## 5 IMMUNITY TEST

### 5.1 GENERAL DESCRIPTION

<b>Product Standard:</b>	<b>EN 55024: 1998+A1: 2001+A2: 2003</b>	
<b>Basic Standard, specification requirement, and Performance Criteria:</b>	IEC 61000-4-2	Electrostatic Discharge – ESD: 8kV air discharge, 4kV Contact discharge, Performance Criterion B
	IEC 61000-4-3	Radio-Frequency Electromagnetic Field Susceptibility Test – RS: 80-1000 MHz, 3V/m, 80% AM (1kHz), Performance Criterion A
	IEC 61000-4-4	Electrical Fast Transient/Burst - EFT AC Power line: 1kV, DC Power line: 0.5kV Signal line: 0.5kV Performance Criterion B
	IEC 61000-4-5	Surge Immunity Test: 1.2/50 us Open Circuit Voltage, 8 /20 us Short Circuit Current AC Power Line: line to line 1 kV, line to earth 2kV DC Power Line: line to earth 0.5kV Signal line: 1kV Performance Criterion B
	IEC 61000-4-6	Conducted Radio Frequency Disturbances Test – CS: 0.15-80 MHz, 3Vrms, 80% AM, 1kHz, Performance Criterion A
	IEC 61000-4-8	Power Frequency Magnetic Field Test, 50 Hz, 1A/m, Performance Criterion A
	IEC 61000-4-11	Voltage Dips: i) >95% reduction -0.5 period, Performance Criterion B ii) 30% reduction – 25 period, Performance Criterion C Voltage Interruptions: i) >95% reduction – 250 period, Performance Criterion C



## 5.2 GENERAL PERFORMANCE CRITERIA DESCRIPTION

According to Clause 7.1 of EN 55024: 1998+A1: 2001 +A2: 2003 standard, the following describes the general performance criteria.

<b>CRITERION A</b>	The equipment shall continue to operate as intended without operator intervention. No degradation of performance or loss of function is allowed below a performance level specified by the manufacturer when the equipment is used as intended. The performance level may be replaced by a permissible loss of performance. If the minimum performance level or the permissible performance loss is not specified by the manufacturer, then either of these may be derived from the product description and documentation, and by what the user may reasonably expect from the equipment if used as intended.
<b>CRITERION B</b>	<p>After the test, the equipment shall continue to operate as intended without operator intervention. No degradation of performance or loss of function is allowed, after the application of the phenomenon below a performance level specified by the manufacturer, when the equipment is used as intended. The performance level may be replaced by a permissible loss of performance.</p> <p>During the test, degradation of performance is allowed. However, no change of operating state if stored data is allowed to persist after the test. If the minimum performance level (or the permissible performance loss) is not specified by the manufacturer, then either of these may be derived from the product description and documentation, and by what the user may reasonably expect from the equipment if used as intended.</p>
<b>CRITERION C</b>	<p>Loss of function is allowed, provided the function is self-recoverable, or can be restored by the operation of the controls by the user in accordance with the manufacturer's instructions.</p> <p>Functions, and/or information stored in non-volatile memory, or protected by a battery backup, shall not be lost.</p>

## 5.3 EUT OPERATING CONDITION

Connected a resistor load to DC output port of EUT to make EUT have maximum power consumption.



## 5.4 ELECTROSTATIC DISCHARGE IMMUNITY TEST (ESD)

### 5.4.1 TEST SPECIFICATION

<b>Basic Standard:</b>	IEC 61000-4-2
<b>Discharge Impedance:</b>	330 ohm / 150 pF
<b>Discharge Voltage:</b>	Air Discharge: 2,4,8 kV (Direct) Contact Discharge: 2,4 kV (Indirect)
<b>Polarity:</b>	Positive & Negative
<b>Number of Discharge:</b>	Air Discharge: min. 20 times at each test point Contact Discharge: min. 200 times in total
<b>Discharge Mode:</b>	Single Discharge
<b>Discharge Period:</b>	1 second minimum

### 5.4.2 TEST INSTRUMENTS

DESCRIPTION & MANUFACTURER	MODEL NO.	SERIAL NO.	CALIBRATED UNTIL
KeyTek, ESD Simulator	MZ-15/EC	0504259	Apr. 17, 2008

- NOTE:** 1. The test was performed in ESD Room No. 1.  
2. The calibration interval of the above test instruments is 12 months and the calibrations are traceable to NML/ROC and NIST/USA.

### 5.4.3 TEST PROCEDURE

The discharges shall be applied in two ways:

- a. Contact discharges to the conductive surfaces and coupling planes:

The EUT shall be exposed to at least 200 discharges, 100 each at negative and positive polarity, at a minimum of four test points. One of the test points shall be subjected to at least 50 indirect discharges to the center of the front edge of the horizontal coupling plane. The remaining three test points shall each receive at least 50 direct contact discharges. If no direct contact test points are available, then at least 200 indirect discharges shall be applied in the indirect mode. Test shall be performed at a maximum repetition rate of one discharge per second.

b. Air discharges at slots and apertures and insulating surfaces:

On those parts of the EUT where it is not possible to perform contact discharge testing, the equipment should be investigated to identify user accessible points where breakdown may occur. Such points are tested using the air discharge method. This investigation should be restricted to those area normally handled by the user. A minimum of 10 single air discharges shall be applied to the selected test point for each such area.

The basic test procedure was in accordance with IEC 61000-4-2:

- a. Electrostatic discharges were applied only to those points and surfaces of the EUT that are accessible to users during normal operation.
- b. The test was performed with at least ten single discharges on the pre-selected points in the most sensitive polarity.
- c. The time interval between two successive single discharges was at least 1 second.
- d. The ESD generator was held perpendicularly to the surface to which the discharge was applied and the return cable was at least 0.2 meters from the EUT.
- e. Contact discharges were applied to the non-insulating coating, with the pointed tip of the generator penetrating the coating and contacting the conducting substrate.
- f. Air discharges were applied with the round discharge tip of the discharge electrode approaching the EUT as fast as possible (without causing mechanical damage) to touch the EUT. After each discharge, the ESD generator was removed from the EUT and re-triggered for a new single discharge. The test was repeated until all discharges were complete.
- g. At least ten single discharges (in the most sensitive polarity) were applied to the **Horizontal Coupling Plane** at points on each side of the EUT. The ESD generator was positioned vertically at a distance of 0.1 meters from the EUT with the discharge electrode touching the **HCP**.
- h. At least ten single discharges (in the most sensitive polarity) were applied to the center of one vertical edge of the **Vertical Coupling Plane** in sufficiently different positions that the four faces of the EUT were completely illuminated. The **VCP** (dimensions 0.5m x 0.5m) was placed vertically to and 0.1 meters from the EUT.

#### 5.4.4 DEVIATION FROM TEST STANDARD

No deviation

## 5.4.5 TEST SETUP

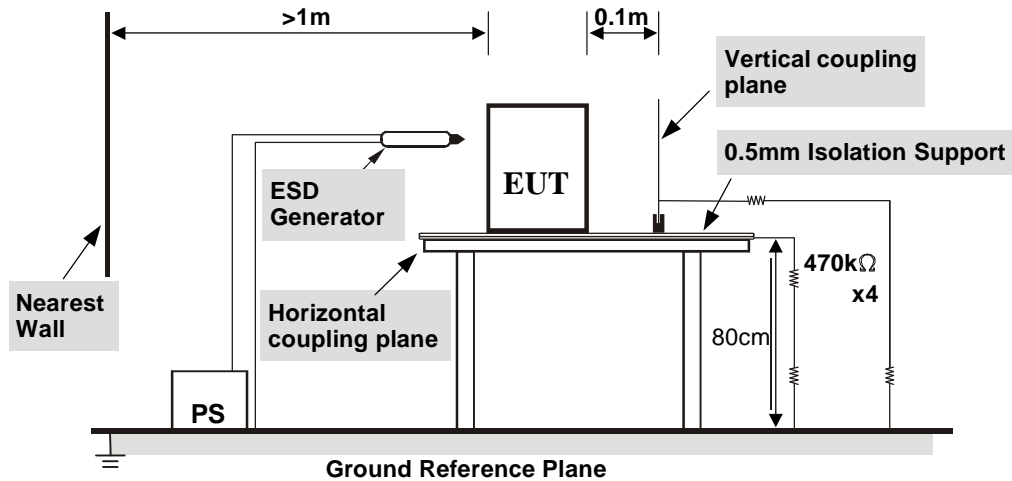

For the actual test configuration, please refer to the related item – Photographs of the Test Configuration.

### NOTE:

#### TABLE-TOP EQUIPMENT

The configuration consisted of a wooden table 0.8 meters high standing on the **Ground Reference Plane**. The **GRP** consisted of a sheet of aluminum at least 0.25mm thick, and 2.5 meters square connected to the protective grounding system. A **Horizontal Coupling Plane** (1.6m x 0.8m) was placed on the table and attached to the **GRP** by means of a cable with 940kΩ total impedance. The equipment under test, was installed in a representative system as described in section 7 of IEC 61000-4-2, and its cables were placed on the **HCP** and isolated by an insulating support of 0.5mm thickness. A distance of 1-meter minimum was provided between the EUT and the walls of the laboratory and any other metallic structure.

#### FLOOR-STANDING EQUIPMENT

The equipment under test was installed in a representative system as described in section 7 of IEC 61000-4-2, and its cables were isolated from the Ground Reference Plane by an insulating support of 0.1-meter thickness. The GRP consisted of a sheet of aluminum that is at least 0.25 mm thick, and 2.5 meters square connected to the protective grounding system and extended at least 0.5 meters from the EUT on all sides.



A D T

## 5.4.6 TEST RESULTS

<b>TEST MODE</b>	Mode 2	<b>INPUT POWER</b>	230 Vac, 50 Hz
<b>ENVIRONMENTAL CONDITIONS</b>	23 deg. C, 49% RH, 1003 hPa	<b>TESTED BY:</b> Andy Chang	

TEST RESULTS OF DIRECT APPLICATION					
Discharge Level (kV)	Polarity (+/-)	Test Point	Contact Discharge	Air Discharge	Performance Criterion
2, 4, 8	+/-	1, 2	N/A	Note	A

**Description of test point:** Please refer to ESD test photo for representative mark only.

TEST RESULTS OF INDIRECT APPLICATION					
Discharge Level (kV)	Polarity (+/-)	Test Point	Horizontal Coupling Plane	Vertical Coupling Plane	Performance Criterion
2, 4	+/-	1 ~ 4	Note	Note	A

**Description of test point:**

1. Left side
2. Right side
3. Front side
4. Rear side

**NOTE:** There was no change compared with the initial operation during the test.

## 5.5 RADIATED, RADIO-FREQUENCY, ELECTROMAGNETIC FIELD IMMUNITY TEST (RS)

### 5.5.1 TEST SPECIFICATION

<b>Basic Standard:</b>	IEC 61000-4-3
<b>Frequency Range:</b>	80 MHz - 1000 MHz
<b>Field Strength:</b>	3 V/m
<b>Modulation:</b>	1kHz Sine Wave, 80%, AM Modulation
<b>Frequency Step:</b>	1 % of fundamental
<b>Polarity of Antenna:</b>	Horizontal and Vertical
<b>Test Distance:</b>	3 m
<b>Antenna Height:</b>	1.5 m
<b>Dwell Time:</b>	at least 3 seconds

### 5.5.2 TEST INSTRUMENTS

DESCRIPTION & MANUFACTURER	MODEL NO.	SERIAL NO.	CALIBRATED UNTIL
R&S Signal Generator	SML03	101074	Nov. 01, 2008
AR RF Amplifier	60S1G3	304334	NA
Electric Field Sensor	CTR1001A	06D00232SN0-02	Aug. 08, 2008
BOONTON RF Voltage Meter	4232A	10180	Jun. 07, 2008
BOONTON Power Sensor	51011-EMC	34152	Jun. 06, 2008
BOONTON Power Sensor	51011-EMC	34153	May 27, 2008
FRANKONIA Power Amplifier	FLH 100	0042	NA
Log-Periodic Antenna	AT 5080	312115	NA
HP-IB Extender	37204	3212U26684	NA
EMCO BiconiLog Antenna	3141	1001	NA
COMTEST Compact Full Anechoic Chamber (7x3x3 m)	CFAC	ADT-S01	Oct. 20, 2008
Software	ADT_RS_V7.6	NA	NA

- NOTE:** 1. The test was performed in RS Room No.1.  
 2. The calibration interval of the above test instruments is 12 months and the calibrations are traceable to NML/ROC and NIST/USA.

### 5.5.3 TEST PROCEDURE

The test procedure was in accordance with IEC 61000-4-3

- a. The testing was performed in a fully-anechoic chamber. The transmit antenna was located at a distance of 3 meters from the EUT.
- b. The frequency range is swept from 80 MHz to 1000 MHz, with the signal 80% amplitude modulated with a 1kHz sinewave. The rate of sweep did not exceed  $1.5 \times 10^{-3}$  decade/s. Where the frequency range is swept incrementally, the step size was 1% of fundamental.
- c. The dwell time at each frequency shall be not less than the time necessary for the EUT to be able to respond.
- d. The field strength level was 3V/m.
- e. The test was performed with the EUT exposed to both vertically and horizontally polarized fields on each of the four sides.

### 5.5.4 DEVIATION FROM TEST STANDARD

No deviation

### 5.5.5 TEST SETUP

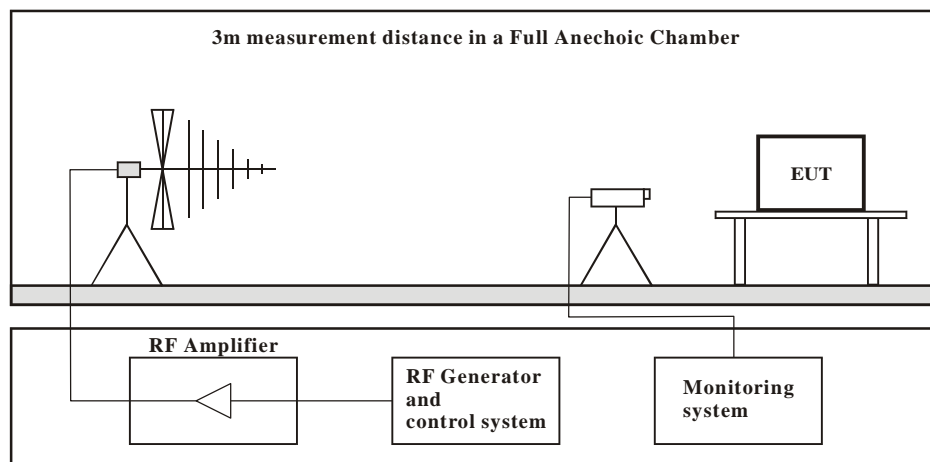

For the actual test configuration, please refer to the related item – Photographs of the Test Configuration.

**NOTE:**

TABLETOP EQUIPMENT

The EUT installed in a representative system as described in section 7 of IEC 61000-4-3 was placed on a non-conductive table 0.8 meters in height. The system under test was connected to the power and signal wire according to relevant installation instructions.

FLOOR STANDING EQUIPMENT

The EUT installed in a representative system as described in section 7 of IEC 61000-4-3 was placed on a non-conductive wood support 0.1 meters in height. The system under test was connected to the power and signal wire according to relevant installation instructions.





## 5.5.6 TEST RESULTS

<b>TEST MODE</b>	Mode 2	<b>INPUT POWER</b>	230 Vac, 50 Hz
<b>ENVIRONMENTAL CONDITIONS</b>	22 deg. C, 64% RH, 1003 hPa	<b>TESTED BY:</b> Andy Chang	

Frequency (MHz)	Polarity	Azimuth	Strength (V/m)	Observation	Performance Criterion
80 -1000	V & H	0	3	Note	A
80 -1000	V & H	90	3		
80 -1000	V & H	180	3		
80 -1000	V & H	270	3		

**NOTE:** There was no change compared with the initial operation during the test.



## 5.6 ELECTRICAL FAST TRANSIENT/BURST IMMUNITY TEST (EFT)

### 5.6.1 TEST SPECIFICATION

<b>Basic Standard:</b>	IEC 61000-4-4
<b>Test Voltage:</b>	Power Line:1 kV Signal/Control Line: N/A
<b>Polarity:</b>	Positive/Negative
<b>Impulse Frequency:</b>	5 kHz
<b>Impulse Waveshape :</b>	5/50 ns
<b>Burst Duration:</b>	15 ms
<b>Burst Period:</b>	300 ms
<b>Test Duration:</b>	Not less than 1 min.

### 5.6.2 TEST INSTRUMENTS

DESCRIPTION & MANUFACTURER	MODEL NO.	SERIAL NO.	CALIBRATED UNTIL
Haefely, EFT Generator	PEFT 4010	154954	Mar. 10, 2009
Haefely,Capacitive Clamp	IP4A	155173	NA

- NOTE:** 1. The test was performed in EMS Room No. 1.  
2. The calibration interval of the above test instruments is 12 months and the calibrations are traceable to NML/ROC and NIST/USA.

### 5.6.3 TEST PROCEDURE

- Both positive and negative polarity discharges were applied.
- The length of the “hot wire” from the coaxial output of the EFT generator to the terminals on the EUT should not exceed 0.5 meter  $\pm$  0.05 meter.
- The duration time of each test sequential was 1 minute.
- The transient/burst waveform was in accordance with IEC 61000-4-4, 5/50ns.

### 5.6.4 DEVIATION FROM TEST STANDARD

No deviation

## 5.6.5 TEST SETUP

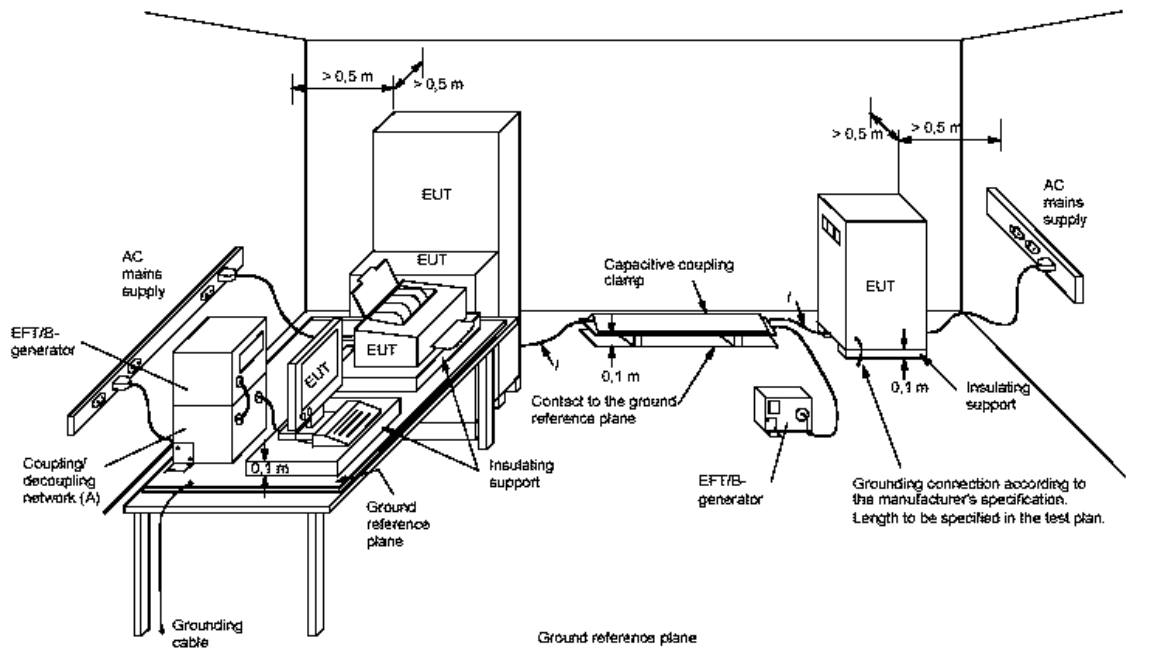

For the actual test configuration, please refer to the related item – Photographs of the Test Configuration.

### **NOTE:** **TABLETOP EQUIPMENT**

The configuration consisted of a wooden table standing on the Ground Reference Plane and should be located 0.1m +/- 0.01m above the Ground Reference Plane. The GRP consisted of a sheet of aluminum (at least 0.25mm thick and 2.5m square) connected to the protective grounding system. A minimum distance of 0.5m was provided between the EUT and the walls of the laboratory or any other metallic structure.

### **FLOOR STANDING EQUIPMENT**

The EUT installed in a representative system as described in section 7 of IEC 61000-4-4 and its cables, were isolated from the Ground Reference Plane by an insulating support that is 0.1-meter thick. The GRP consisted of a sheet of aluminum (at least 0.25mm thick and 2.5m square) connected to the protective grounding system.

### 5.6.6 TEST RESULTS

<b>TEST MODE</b>	Mode 2	<b>INPUT POWER</b>	230 Vac, 50 Hz
<b>ENVIRONMENTAL CONDITIONS</b>	21 deg. C, 62% RH, 1003 hPa	<b>TESTED BY:</b> Andy Chang	

Test Point	Polarity	Test Level (Kv)	Observation	Performance Criterion
L1	+/-	1	Note	A
L2	+/-	1	Note	A
L1-L2	+/-	1	Note	A

**NOTE:** There was no change compared with the initial operation during the test.

## 5.7 SURGE IMMUNITY TEST

### 5.7.1 TEST SPECIFICATION

<b>Basic Standard:</b>	IEC 61000-4-5
<b>Wave-Shape:</b>	Combination Wave 1.2/50 us Open Circuit Voltage 8 /20 us Short Circuit Current
<b>Test Voltage:</b>	Power Line: 0.5 kV / 1kV
<b>Surge Input/Output:</b>	L1-L2
<b>Generator Source</b>	2 ohm between networks
<b>Impedance:</b>	12 ohm between network and ground
<b>Polarity:</b>	Positive/Negative
<b>Phase Angle:</b>	0° /90°/180°/270°
<b>Pulse Repetition Rate:</b>	1 time / min. (maximum)
<b>Number of Tests:</b>	5 positive and 5 negative at selected points

### 5.7.2 TEST INSTRUMENTS

DESCRIPTION & MANUFACTURER	MODEL NO.	SERIAL NO.	CALIBRATED UNTIL
KeyTek, Surge Combination Wave	E501A	9508349	Sep. 09, 2008
KeyTek, Surge Coupler/Decoupler	E551	9508350	Sep. 09, 2008
KeyTek External Coupler/Decoupler for Telecom Lines	CM-TELCD	9906194	NA
KeyTek I/O Signal Line Coupler/Decoupler	CM-I/OCD	9907177	NA
Surge Cable	WE-4	SU1Cab-001	NA
Surge Adapter WONPRO	WA-9	SU1ADA-002	NA
Software	E500	NA	NA

- NOTE:** 1. The test was performed in Surge Room.  
2. The calibration interval of the above test instruments is 12 months and the calibrations are traceable to NML/ROC and NIST/USA.

### 5.7.3 TEST PROCEDURE

- a. For EUT power supply:

The surge is to be applied to the EUT power supply terminals via the capacitive coupling network. Decoupling networks are required in order to avoid possible adverse effects on equipment not under test that may be powered by the same lines, and to provide sufficient decoupling impedance to the surge wave. The power cord between the EUT and the coupling/decoupling networks shall be 2 meters in length (or shorter).

- b. For test applied to unshielded unsymmetrically operated interconnection lines of EUT:

The surge is applied to the lines via the capacitive coupling. The coupling / decoupling networks shall not influence the specified functional conditions of the EUT. The interconnection line between the EUT and the coupling/decoupling networks shall be 2 meters in length (or shorter).

- c. For test applied to unshielded symmetrically operated interconnection / telecommunication lines of EUT:

The surge is applied to the lines via gas arrestors coupling. Test levels below the ignition point of the coupling arrestor cannot be specified. The interconnection line between the EUT and the coupling/decoupling networks shall be 2 meters in length (or shorter).

### 5.7.4 DEVIATION FROM TEST STANDARD

No deviation

## 5.7.5 TEST SETUP

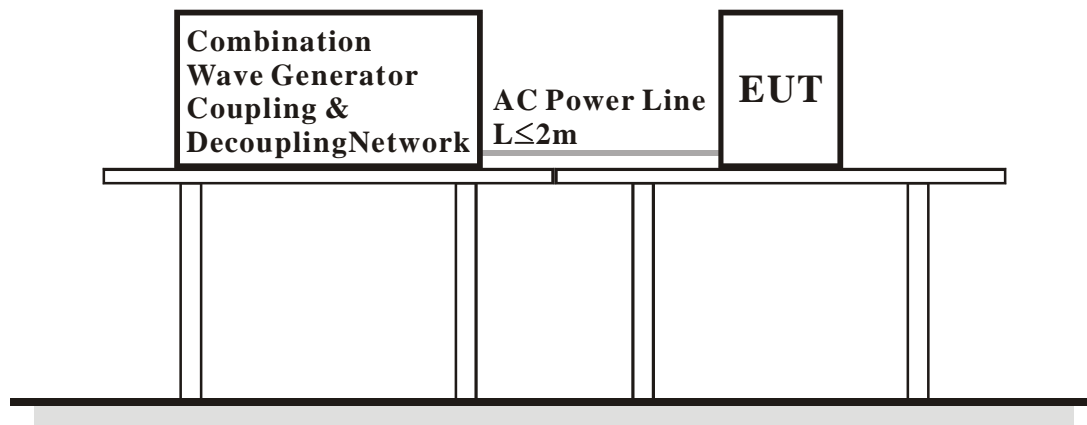

For the actual test configuration, please refer to the related item – Photographs of the Test Configuration.

### 5.7.6 TEST RESULTS

<b>TEST MODE</b>	Mode 2	<b>INPUT POWER</b>	230 Vac, 50 Hz
<b>ENVIRONMENTAL CONDITIONS</b>	22 deg. C, 62% RH, 1002 hPa	<b>TESTED BY:</b> Andy Chang	

<b>VOLTAGE (kV)</b>	<b>TEST POINT</b>	<b>POLARITY (+/-)</b>	<b>OBSERVATION</b>	<b>PERFORMANCE CRITERION</b>
0.5, 1	L1-L2	+/-	Note	A

**NOTE:** There was no change compared with the initial operation during the test.



## 5.8 IMMUNITY TO CONDUCTED DISTURBANCES INDUCED BY RF FIELDS (CS)

### 5.8.1 TEST SPECIFICATION

<b>Basic Standard:</b>	IEC 61000-4-6
<b>Frequency Range:</b>	0.15 MHz - 80 MHz
<b>Field Strength:</b>	3 $V_{r.m.s}$
<b>Modulation:</b>	1kHz Sine Wave, 80%, AM Modulation
<b>Frequency Step:</b>	1 % of fundamental
<b>Coupled Cable:</b>	Power Mains
<b>Coupling Device:</b>	CDN-M2 (2 wires)

### 5.8.2 TEST INSTRUMENTS

DESCRIPTION & MANUFACTURER	MODEL NO.	SERIAL NO.	CALIBRATED UNTIL
ROHDE & SCHWARZ Signal Generator	SMY01	841104/033	Nov. 27, 2008
Digital Sweep Function Generator	8120	984801	NA
AR Power Amplifier	75A250AM1	306331	NA
FCC Coupling Decoupling Network	FCC-801-M3-25A	48	Jul. 22, 2008
FCC Coupling Decoupling Network	FCC-801-M3-25A	01022	Mar. 02, 2009
FCC Coupling Decoupling Network	FCC-801-M2-16A	01047	Jul. 13, 2008
FISCHER CUSTOM COMMUNICATIONS EM Injection Clamp	FCC-203I	50	NA
FCC Coupling Decoupling Network	FCC-801-T8	02038	May 28, 2008
FCC Coupling Decoupling Network	FCC-801-T2	02020	May 28, 2008
FCC Coupling Decoupling Network	FCC-801-T4	02031	Jun. 14, 2008
R&S Power Sensor	NRV-Z5	837878/038	Oct. 25, 2008
R&S Power Sensor	NRV-Z5	837878/039	Oct. 25, 2008
R&S Power Meter	NRVD	837794/040	Oct. 25, 2008
Software	ADT_CS_V7.3.8	NA	NA

- NOTE:** 1. The test was performed in CS Room No. 1.  
2. The calibration interval of the above test instruments is 12 months and the calibrations are traceable to NML/ROC and NIST/USA.

### 5.8.3 TEST PROCEDURE

- a. The EUT shall be tested within its intended operating and climatic conditions.
- b. The test shall be performed with the test generator connected to each of the coupling and decoupling devices in turn, while the other non-excited RF input ports of the coupling devices are terminated by a 50-ohm load resistor.
- c. The frequency range is swept from 150 kHz to 80 MHz, using the signal level established during the setting process and with a disturbance signal of 80 % amplitude. The signal is modulated with a 1 kHz sine wave, pausing to adjust the RF signal level or the switch coupling devices as necessary. The sweep rate shall not exceed  $1.5 \times 10^{-3}$  decades/s. The step size shall not exceed 1 % of the start and thereafter 1 % of the preceding frequency value where the frequency is swept incrementally.
- d. The dwell time at each frequency shall not be less than the time necessary for the EUT to be exercised, and able to respond. Sensitive frequencies such as clock frequency (ies) and harmonics or frequencies of dominant interest, shall be analyzed separately.
- e. Attempts should be made to fully exercise the EUT during testing, and to fully interrogate all exercise modes selected for susceptibility.

### 5.8.4 DEVIATION FROM TEST STANDARD

No deviation

## 5.8.5 TEST SETUP

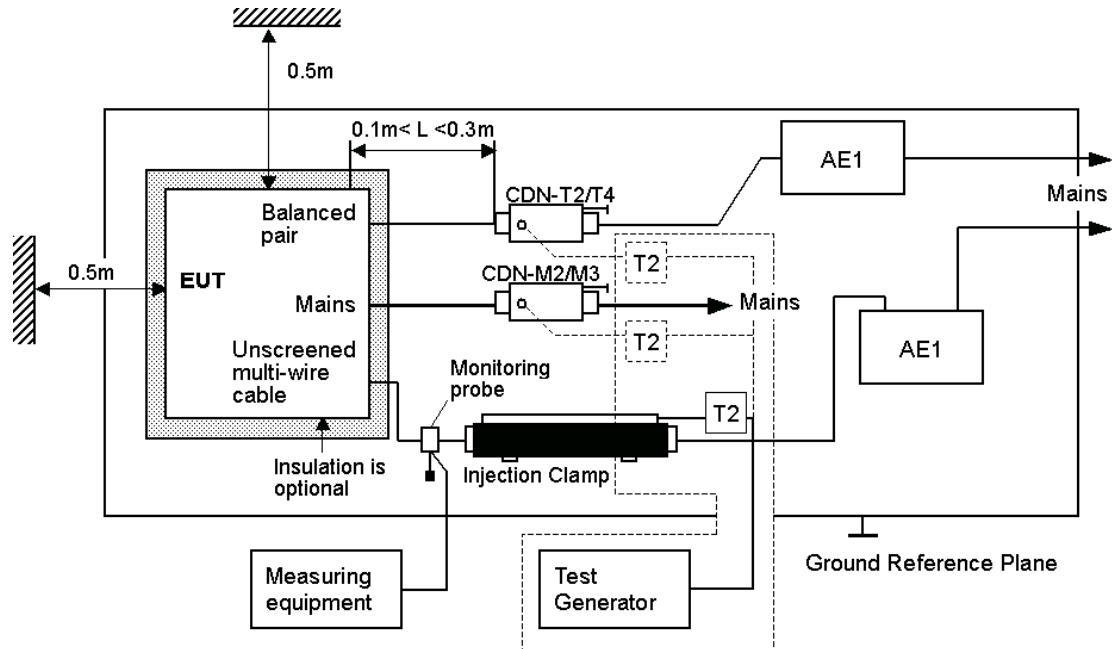

NOTE: The EUT clearance from any metallic obstacles shall be at least 0.5m.  
All non-excited input ports of the CDNs shall be terminated by  $50\Omega$  loads.

For the actual test configuration, please refer to the related item – Photographs of the Test Configuration.

### NOTE:

#### FLOOR-STANDING EQUIPMENT

The equipment to be tested is placed on an insulating support of 0.1 meters height above a ground reference plane. All relevant cables shall be provided with the appropriate coupling and decoupling devices at a distance between 0.1 meters and 0.3 meters from the projected geometry of the EUT on the ground reference plane.

### 5.8.6 TEST RESULTS

<b>TEST MODE</b>	Mode 2	<b>INPUT POWER</b>	230 Vac, 50 Hz
<b>ENVIRONMENTAL CONDITIONS</b>	22 deg. C, 74% RH, 1003 hPa	<b>TESTED BY:</b> Jiannren Hsieh	

<b>FREQUENCY (MHz)</b>	<b>FIELD STRENGTH (V<sub>r.m.s.</sub>)</b>	<b>CABLE</b>	<b>OBSER- VATION</b>	<b>INJECTION METHOD</b>	<b>PERFORMANCE CRITERION</b>
0.15 –80 MHz	3	AC power line	Note	CDN-M2	A

**NOTE:** There is no change compared with the initial operation during the test.

## 5.9 POWER FREQUENCY MAGNETIC FIELD IMMUNITY TEST

### 5.9.1 TEST SPECIFICATION

<b>Basic Standard:</b>	IEC 61000-4-8
<b>Frequency Range:</b>	50Hz
<b>Field Strength:</b>	1 A/m
<b>Observation Time:</b>	1 minute
<b>Inductance Coil:</b>	Rectangular type, 1 m x 1 m

### 5.9.2 TEST INSTRUMENTS

DESCRIPTION & MANUFACTURER	MODEL NO.	SERIAL NO.	CALIBRATED UNTIL
HAEFELY Magnetic Field Tester	MAG 100.1	083794-06	NA
COMBINOVA Magnetic Field Meter	MFM10	224	Aug. 23, 2008

- NOTE:** 1. The test was performed in EMS Room No. 1.  
 2. The calibration interval of the above test instruments is 12 months and the calibrations are traceable to NML/ROC and NIST/USA.

### 5.9.3 TEST PROCEDURE

- The equipment is configured and connected to satisfy its functional requirements.
- The power supply, input and output circuits shall be connected to the sources of power supply, control and signal.
- The cables supplied or recommended by the equipment manufacturer shall be used. 1 meter of all cables used shall be exposed to the magnetic field.

### 5.9.4 DEVIATION FROM TEST STANDARD

No deviation

## 5.9.5 TEST SETUP

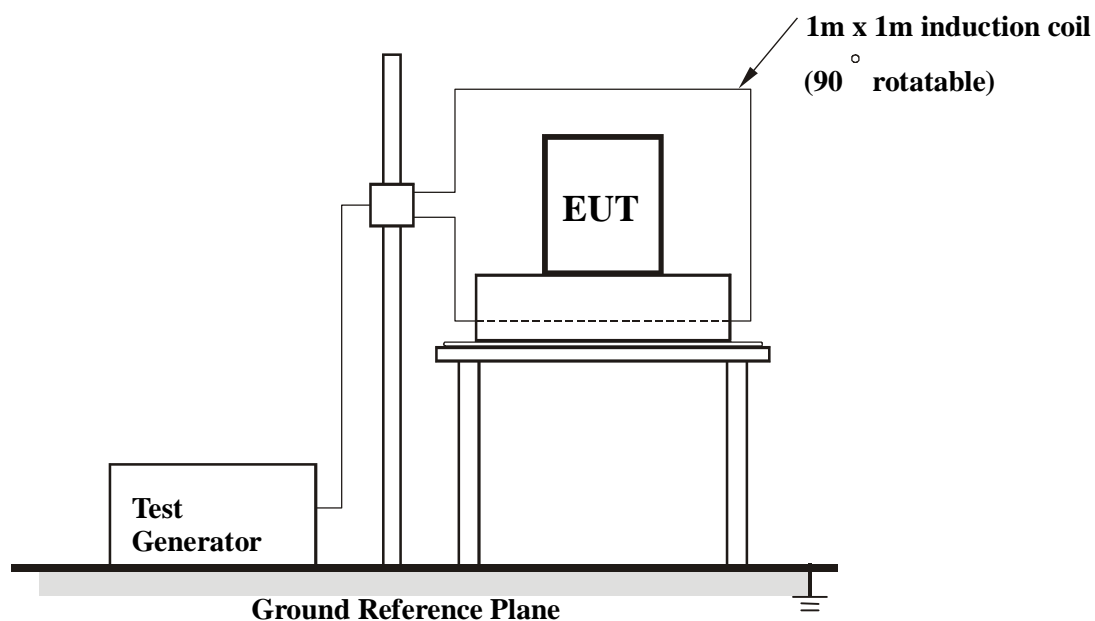

For the actual test configuration, please refer to the related item – Photographs of the Test Configuration.

### NOTE:

#### TABLETOP EQUIPMENT

The equipment shall be subjected to the test magnetic field by using the induction coil of standard dimension (1 m x 1 m). The induction coil shall then be rotated by 90 degrees in order to expose the EUT to the test field with different orientations.

#### FLOOR-STANDING EQUIPMENT

The equipment shall be subjected to the test magnetic field by using induction coils of suitable dimensions. The test shall be repeated by moving and shifting the induction coils, in order to test the whole volume of the EUT for each orthogonal direction. The test shall be repeated with the coil shifted to different positions along the side of the EUT, in steps corresponding to 50 % of the shortest side of the coil. The induction coil shall then be rotated by 90 degrees in order to expose the EUT to the test field with different orientations.

### 5.9.6 TEST RESULTS

<b>TEST MODE</b>	Mode 2	<b>INPUT POWER</b>	230 Vac, 50 Hz
<b>ENVIRONMENTAL CONDITIONS</b>	22 deg. C, 72% RH, 1003 hPa	<b>TESTED BY:</b> Bin Cheng	

Direction	Field Strength (A/m)	Observation	Performance Criterion
X - Axis	1	Note	A
Y - Axis	1	Note	A
Z - Axis	1	Note	A

**NOTE:** There was no change compared with the initial operation during the test.

## 5.10 VOLTAGE DIP/SHORT INTERRUPTIONS/VOLTAGE VARIATIONS (DIP) IMMUNITY TEST

### 5.10.1 TEST SPECIFICATION

<b>Basic Standard:</b>	IEC 61000-4-11
<b>Test Duration Time:</b>	Minimum three test events in sequence
<b>Interval between Event:</b>	Minimum ten seconds
<b>Phase Angle:</b>	0°/180°
<b>Test Cycle:</b>	3 times

### 5.10.2 TEST INSTRUMENTS

DESCRIPTION & MANUFACTURER	MODEL NO.	SERIAL NO.	CALIBRATED UNTIL
HAEFELY Mains Interference Simulator	PLINE1610	083690-17	May 08, 2008

- NOTE:** 1. The test was performed in EMS Room No. 1.  
 2. The calibration interval of the above test instruments is 12 months and the calibrations are traceable to NML/ROC and NIST/USA.

### 5.10.3 TEST PROCEDURE

The EUT shall be tested for each selected combination of test levels and duration with a sequence of three dips/interruptions with intervals of 10 s minimum (between each test event). Each representative mode of operation shall be tested. Abrupt changes in supply voltage shall occur at zero crossings of the voltage waveform.

### 5.10.4 DEVIATION FROM TEST STANDARD

No deviation



## 5.10.5 TEST SETUP

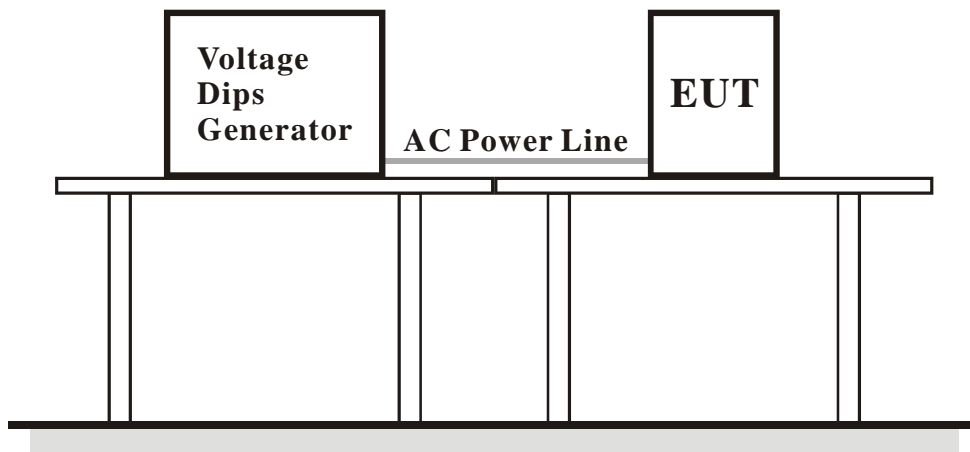

For the actual test configuration, please refer to the related item – Photographs of the Test Configuration.

### 5.10.6 TEST RESULTS

<b>TEST MODE</b>	Mode 2	<b>INPUT POWER</b>	230 Vac, 50 Hz, 100 Vac, 50 Hz
<b>ENVIRONMENTAL CONDITIONS</b>	21 deg. C, 62% RH, 1003 hPa	<b>TESTED BY:</b> Andy Chang	

Input Power for testing: 230Vac, 50Hz			
VOLTAGE % REDUCTION	PERIODS	OBSERVATION	PERFORMANCE CRITERION
>95	0.5	Note (1)	A
30	25	Note (1)	A
>95	250	Note (2)	B

Input Power for testing: 100 Vac, 50 Hz			
VOLTAGE % REDUCTION	PERIODS	OBSERVATION	PERFORMANCE CRITERION
>95	0.5	Note (1)	A
30	25	Note (1)	A
>95	250	Note (2)	B

**NOTE:** (1) There was no change compared with the initial operation during the test.  
(2) The EUT reset during the test.

## 6 PHOTOGRAPHS OF THE TEST CONFIGURATION

CONDUCTED EMISSION TEST <For DC O/P 24V >



### CONDUCTED EMISSION TEST <For DC O/P 48V >



### RADIATED EMISSION TEST



## HARMONICS EMISSION TEST & VOLTAGE FLUCTUATIONS AND FLICKER TEST



## ESD TEST



### ESD TEST POINT

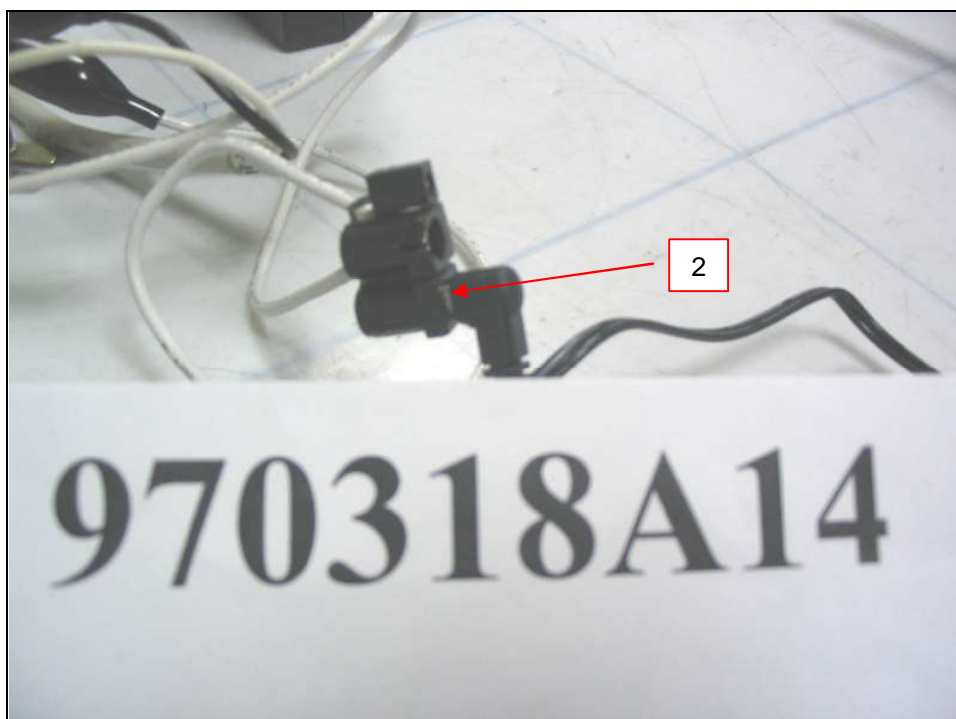
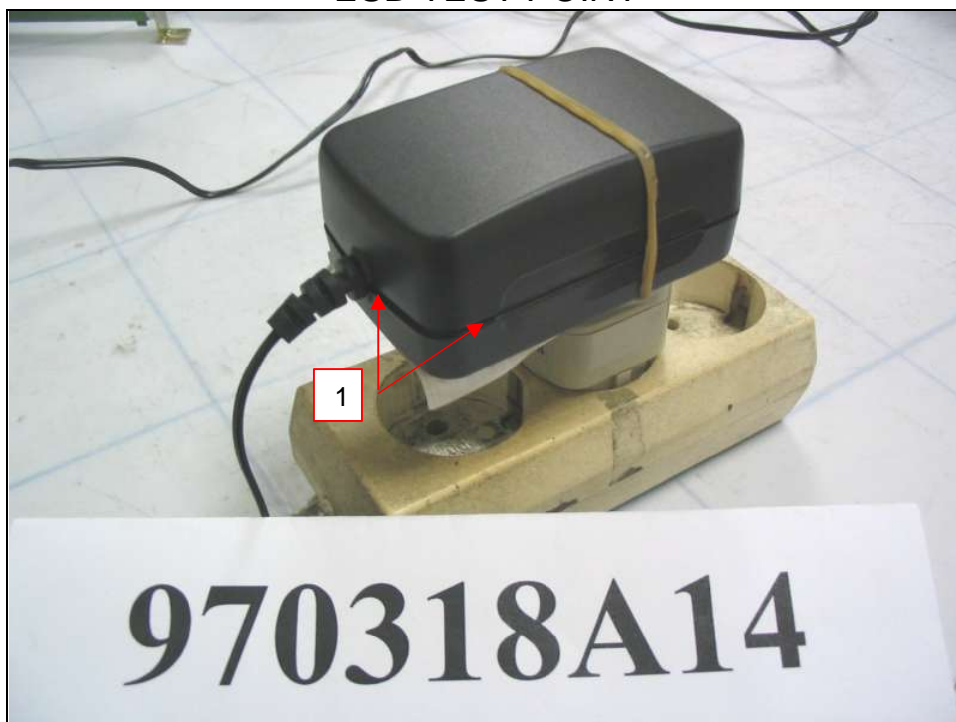

## RS TEST





### EFT TEST

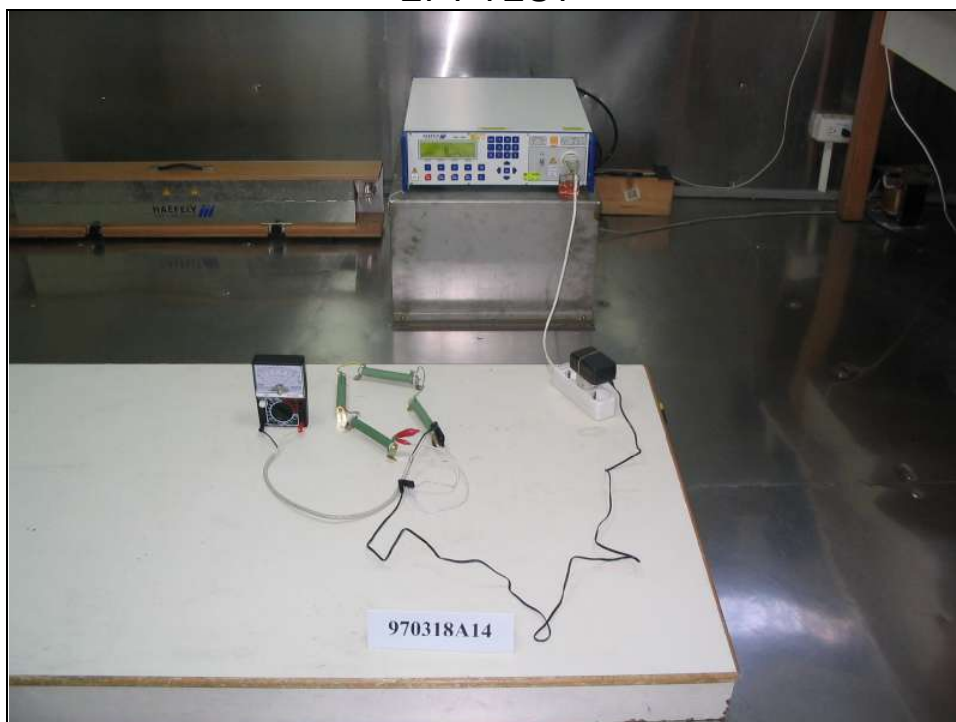

### SURGE TEST

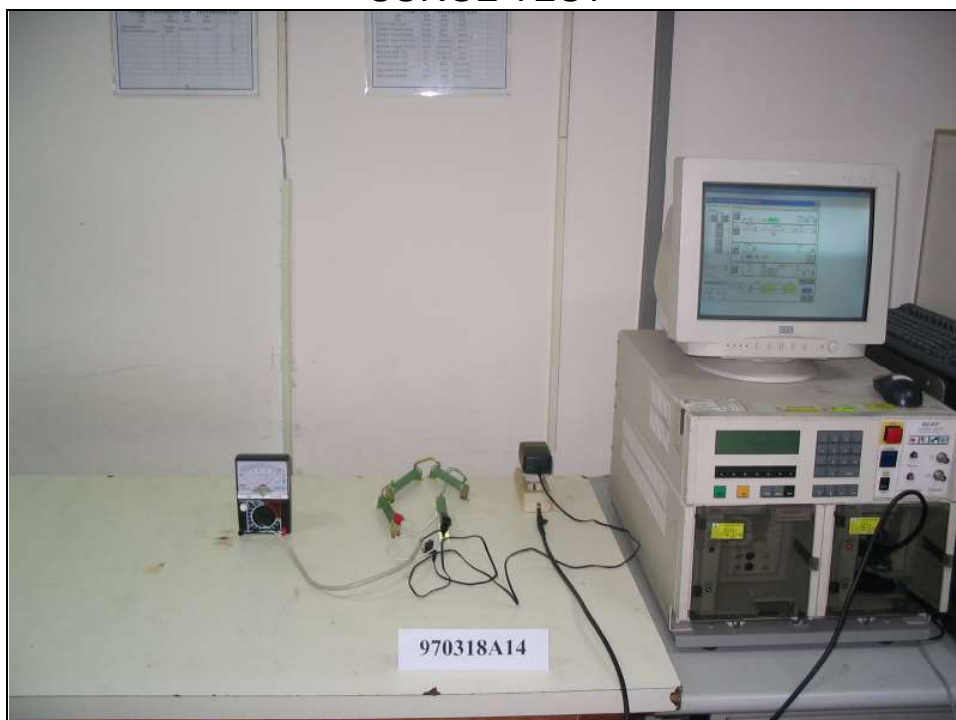

### CONDUCTED SUSCEPTIBILITY TEST



### POWER-FREQUENCY MAGNETIC FIELDS TEST



## VOLTAGE DIPS AND INTERRUPTIONS TEST





## 7 APPENDIX - INFORMATION ON THE TESTING LABORATORIES

We, Bureau Veritas Consumer Products Services (H.K.) Ltd., Taoyuan Branch, were founded in 1988 to provide our best service in EMC, Radio, Telecom and Safety consultation. Our laboratories are accredited and approved according to ISO/IEC 17025.

Copies of accreditation certificates of our laboratories obtained from approval agencies can be downloaded from our web site: [www.adt.com.tw/index.5/phtml](http://www.adt.com.tw/index.5/phtml). If you have any comments, please feel free to contact us at the following:

**Linko EMC/RF Lab:**

Tel: 886-2-26052180

Fax: 886-2-26051924

**Hsin Chu EMC/RF Lab:**

Tel: 886-3-5935343

Fax: 886-3-5935342

**Hwa Ya EMC/RF/Safety/Telecom Lab:**

Tel: 886-3-3183232

Fax: 886-3-3185050

**Email:** [service@adt.com.tw](mailto:service@adt.com.tw)

**Web Site:** [www.adt.com.tw](http://www.adt.com.tw)

The address and road map of all our labs can be found in our web site also.

---END---