



CE EMC TEST REPORT

REPORT NO.: CP980930A09A

MODEL NO.: GT-41130-WVVV-X.X-TZ series
– *multiple listing see item 3.1*

RECEIVED: Sep. 30, 2009

TESTED: Oct. 1 ~ 9, 2009

ISSUED: July 2, 2010

APPLICANT: GlobTek, Inc..

ADDRESS: 186 Veterans Dr. Northvale, NJ 07647 USA

ISSUED BY: Bureau Veritas Consumer Products Services (H.K.)
Ltd., Taoyuan Branch

LAB LOCATION: No. 47, 14th Ling, Chia Pau Tsuen, Lin Kou Hsiang,
Taipei Hsien 244, Taiwan

This test report consists of 89 pages in total. It may be duplicated completely for legal use with the approval of the applicant. It should not be reproduced except in full, without the written approval of our laboratory. The client should not use it to claim product certification, approval, or endorsement by TAF, NVLAP, NIST or any government agencies. The test results in the report only apply to the tested sample. The test results in this report are traceable to the national or international standards.





Table of Contents

1	CERTIFICATION.....	5
2	SUMMARY OF TEST RESULTS.....	7
2.1	MEASUREMENT UNCERTAINTY	9
3	GENERAL INFORMATION	10
3.1	GENERAL DESCRIPTION OF EUT.....	10
3.2	DESCRIPTION OF TEST MODES.....	11
3.3	GENERAL DESCRIPTION OF APPLIED STANDARDS	12
3.4	DESCRIPTION OF SUPPORT UNITS.....	13
3.4.1	FOR EMISSION TEST	13
3.4.2	FOR HARMONICS, FLICKER & IMMUNITY TEST.....	14
4	EMISSION TEST.....	15
4.1	CONDUCTED EMISSION MEASUREMENT	15
4.1.1	LIMITS OF CONDUCTED EMISSION MEASUREMENT.....	15
4.1.2	TEST INSTRUMENTS	16
4.1.3	TEST PROCEDURE	17
4.1.4	DEVIATION FROM TEST STANDARD	17
4.1.5	TEST SETUP	18
4.1.6	EUT OPERATING CONDITIONS.....	18
4.1.7	TEST RESULTS (1)	19
4.1.8	TEST RESULTS (2)	21
4.1.9	TEST RESULTS (3)	23
4.1.10	TEST RESULTS (4)	25
4.1.11	TEST RESULTS (5)	27
4.2	RADIATED EMISSION MEASUREMENT	29
4.2.1	LIMITS OF RADIATED EMISSION MEASUREMENT.....	29
4.2.2	TEST INSTRUMENTS	30
4.2.3	TEST PROCEDURE	31
4.2.4	DEVIATION FROM TEST STANDARD	31
4.2.5	TEST SETUP	32
4.2.6	EUT OPERATING CONDITIONS.....	32
4.2.7	TEST RESULTS (1)	33
4.2.8	TEST RESULTS (2)	35
4.3	HARMONICS CURRENT MEASUREMENT	37
4.3.1	LIMITS OF HARMONICS CURRENT MEASUREMENT.....	37
4.3.2	TEST INSTRUMENTS	37
4.3.3	TEST PROCEDURE	38
4.3.4	DEVIATION FROM TEST STANDARD	38
4.3.5	TEST SETUP	39
4.3.6	EUT OPERATING CONDITIONS.....	39
4.3.7	TEST RESULTS.....	40
4.4	VOLTAGE FLUCTUATION AND FLICKS MEASUREMENT	41



4.4.1	LIMITS OF VOLTAGE FLUCTUATION AND FLICKS MEASUREMENT	41
4.4.2	TEST INSTRUMENTS	41
4.4.3	TEST PROCEDURE	41
4.4.4	DEVIATION FROM TEST STANDARD	42
4.4.5	TEST SETUP	42
4.4.6	EUT OPERATING CONDITIONS	42
4.4.7	TEST RESULTS	43
5	IMMUNITY TEST	44
5.1	GENERAL DESCRIPTION	44
5.2	GENERAL PERFORMANCE CRITERIA DESCRIPTION	46
5.3	EUT OPERATING CONDITION	47
5.4	ELECTROSTATIC DISCHARGE IMMUNITY TEST (ESD)	48
5.4.1	TEST SPECIFICATION	48
5.4.2	TEST INSTRUMENTS	48
5.4.3	TEST PROCEDURE	48
5.4.4	DEVIATION FROM TEST STANDARD	49
5.4.5	TEST SETUP	50
5.4.6	TEST RESULTS	51
5.5	RADIATED, RADIO-FREQUENCY, ELECTROMAGNETIC FIELD IMMUNITY TEST (RS)	52
5.5.1	TEST SPECIFICATION	52
5.5.2	TEST INSTRUMENTS	53
5.5.3	TEST PROCEDURE	54
5.5.4	DEVIATION FROM TEST STANDARD	54
5.5.5	TEST SETUP	54
5.5.6	TEST RESULTS	55
5.6	RADIO-FREQUENCY ELECTROMAGNETIC FIELD – KEYED CARRIER TEST	56
5.6.1	TEST SPECIFICATION	56
5.6.2	TEST INSTRUMENTS	57
5.6.3	TEST PROCEDURE	58
5.6.4	DEVIATION FROM TEST STANDARD	58
5.6.5	TEST SETUP	58
5.6.6	TEST RESULTS	59
5.7	ELECTRICAL FAST TRANSIENT/BURST IMMUNITY TEST (EFT)	60
5.7.1	TEST SPECIFICATION	60
5.7.2	TEST INSTRUMENTS	60
5.7.3	TEST PROCEDURE	60
5.7.4	DEVIATION FROM TEST STANDARD	60
5.7.5	TEST SETUP	61
5.7.6	TEST RESULTS	62
5.8	SURGE IMMUNITY TEST	63
5.8.1	TEST SPECIFICATION	63
5.8.2	TEST INSTRUMENTS	63
5.8.3	TEST PROCEDURE	64
5.8.4	DEVIATION FROM TEST STANDARD	64



5.8.5	TEST SETUP	64
5.8.6	TEST RESULTS.....	65
5.9	IMMUNITY TO CONDUCTED DISTURBANCES INDUCED BY RF FIELDS (CS).....	66
5.9.1	TEST SPECIFICATION	66
5.9.2	TEST INSTRUMENTS	67
5.9.3	TEST PROCEDURE	68
5.9.4	DEVIATION FROM TEST STANDARD	68
5.9.5	TEST SETUP	69
5.9.6	TEST RESULTS.....	70
5.10	POWER FREQUENCY MAGNETIC FIELD IMMUNITY TEST.....	71
5.10.1	TEST SPECIFICATION.....	71
5.10.2	TEST INSTRUMENTS	71
5.10.3	TEST PROCEDURE	71
5.10.4	DEVIATION FROM TEST STANDARD	71
5.10.5	TEST SETUP	72
5.10.6	TEST RESULTS.....	73
5.11	VOLTAGE DIP/SHORT INTERRUPTIONS/VOLTAGE VARIATIONS (DIP) IMMUNITY TEST	74
5.11.1	TEST SPECIFICATION	74
5.11.2	TEST INSTRUMENTS	74
5.11.3	TEST PROCEDURE	74
5.11.4	DEVIATION FROM TEST STANDARD	74
5.11.5	TEST SETUP	75
5.11.6	TEST RESULTS – FOR EN 61204-3	76
5.11.7	TEST RESULTS – FOR EN 55024	77
6	PHOTOGRAPHS OF THE TEST CONFIGURATION.....	78
7	APPENDIX - INFORMATION ON THE TESTING LABORATORIES.....	89



1 CERTIFICATION

PRODUCT: Switching-Mode Power Supply
BRAND NAME: GlobTek
MODEL NO.: GT-41130-WWVV-X.X-TZ series – *multiple listing see item 3.1*
TEST ITEM: PROTOTYPE
APPLICANT: GlobTek,Inc..
TESTED: Oct. 1 ~ 9, 2009

STANDARDS: **EN 61204-3: 2000, Class B** **EN 55022: 2006+A1: 2007, Class B**
Emission: **CISPR 22: 2005+A1: 2005, Class B**
CISPR 22: 1997, Class B **AS/NZS CISPR 22: 2006, Class B**
IEC 61000-3-2: 2005 **EN 61000-3-2:2006**
IEC 61000-3-3: 2008 **EN 61000-3-3: 2008**
Immunity: **EN 55024: 1998+A1: 2001+A2: 2003**
IEC 61000-4-2: 2008 ED.2.0 IEC 61000-4-2: 2008 ED.2.0
IEC 61000-4-3: 2006+A1: 2007 ED.3.0 IEC 61000-4-3: 2006+A1: 2007 ED.3.0
IEC 61000-4-4: 2004 ED.2.0 IEC 61000-4-4: 2004 ED.2.0
IEC 61000-4-5: 2005 ED.2.0 IEC 61000-4-5: 2005 ED.2.0
IEC 61000-4-6: 2005 ED.2.0 IEC 61000-4-6: 2008 ED.3.0
IEC 61000-4-6: 2008 ED.3.0 IEC 61000-4-8: 2009 ED.2.0
IEC 61000-4-11: 2004 ED.2.0 IEC 61000-4-11: 2004 ED.2.0

The above equipment has been tested by **Bureau Veritas Consumer Products Services (H.K.) Ltd., Taoyuan Branch**, and found compliance with the requirement of the above standards.

Approval signature – on next page



CERTIFICATION – Continued

The test record, data evaluation & Equipment Under Test (EUT) configurations represented herein are true and accurate accounts of the measurements of the sample's EMC characteristics under the conditions specified in this report.

PREPARED BY : Vivian Chen , **DATE:** July 2, 2010
(Vivian Chen / Specialist)

TECHNICAL ACCEPTANCE : Joyce Chen , **DATE:** July 2, 2010
(Joyce Chen / Senior Engineer)

APPROVED BY : Kenny Meng , **DATE:** July 2, 2010
(Kenny Meng / Assistant Manager)

2 SUMMARY OF TEST RESULTS

The EUT has been tested according to the following specifications:

EMISSION			
Standard	Test Type	Result	Remarks
CISPR 22: 1997, Class B EN 55022: 2006 +A1: 2007, Class B	Conducted Test	PASS	Meets Class B Limit Minimum passing margin is -2.33 dB at 0.490 MHz
CISPR 22: 2005 +A1: 2005, Class B AS/NZS CISPR 22: 2006, Class B	Radiated Test (30MHz to 1GHz)	PASS	Meets Class B Limit Minimum passing margin is -6.09 dB at 65.65 MHz
IEC 61000-3-2: 2005 EN 61000-3-2: 2006	Harmonic current emissions	PASS	The power consumption of EUT is less than 75W and no limits apply.
IEC 61000-3-3:2008 EN 61000-3-3:2008	Voltage fluctuations & flicker	PASS	Meets the requirements.

Note: The EUT highest frequency generated below 108MHz and therefore the test frequency range was performed for 30MHz to 1GHz for radiated emission test.



IMMUNITY (EN 61204-3: 2000) & (EN 55024: 1998+A1: 2001+A2: 2003)			
Standard	Test Type	Result	Remarks
IEC 61000-4-2: 2008 ED.2.0	Electrostatic discharge immunity test	PASS	Meets the requirements of Performance Criterion A
IEC 61000-4-3: 2006 +A1: 2007 ED.3.0	Radiated, radio-frequency, electromagnetic field immunity test	PASS	Meets the requirements of Performance Criterion A
IEC 61000-4-4: 2004 ED.2.0	Electrical fast transient / burst immunity test.	PASS	Meets the requirements of Performance Criterion B
IEC 61000-4-5: 2005 ED.2.0	Surge immunity test	PASS	Meets the requirements of Performance Criterion A
IEC 61000-4-6: 2008 ED.3.0	Immunity to conducted disturbances, induced by radio-frequency fields	PASS	Meets the requirements of Performance Criterion A
IEC 61000-4-8: 2009 ED.2.0 <i>(for EN 55024 only)</i>	Power frequency magnetic field immunity test.	PASS	Meets the requirements of Performance Criterion A
IEC 61000-4-11: 2004 ED.2.0 <i>(for EN 61204-3)</i>	Voltage dips, short interruptions and voltage variations immunity tests	PASS	Meets the requirements of Voltage Dips: i).30% reduction – Performance Criterion A ii).60% reduction – Performance Criterion B Voltage Interruptions: i).>95% reduction – Performance Criterion B
IEC 61000-4-11: 2004 ED.2.0 <i>(for EN 55024)</i>	Voltage dips, short interruptions and voltage variations immunity tests	PASS	Meets the requirements of Voltage Dips: i). >95% reduction – Performance Criterion A ii). 30% reduction – Performance Criterion B Voltage Interruptions: i). >95% reduction – Performance Criterion B

2.1 MEASUREMENT UNCERTAINTY

Where relevant, the following measurement uncertainty levels have been estimated for tests performed on the EUT as specified in CISPR 16-4-2:

This uncertainty represents an expanded uncertainty expressed at approximately the 95% confidence level using a coverage factor of $k=2$.

MEASUREMENT	UNCERTAINTY
Conducted emissions	3.43 dB
Radiated emissions	3.69 dB

3 GENERAL INFORMATION

3.1 GENERAL DESCRIPTION OF EUT

PRODUCT	Switching-Mode Power Supply
MODEL NO.	GT-41130-WWVV-X.X-TZ series - <i>multiple listing as below</i>
POWER SUPPLY	Switching Rating refer to below Power Cord: Non-shielded DC (1.8m) / Non-shielded DC (1.5m) with one ferrite core
DATA CABLE SUPPLIED	N/A

NOTE:

- The EUT is a Switching-Mode Power Supply (AC 3-pin) and the definition of model number is as the following:
 - ♦ WW is the rated output wattage designation, with a maximum value of "24".
 - ♦ VV is the standard rated output voltage designation, with a maximum value of "24".
 - ♦ -X.X is optional or blank and denotes the output voltage differentiator, subtracting or adding X.X volts from standard output voltage VV in 0.1V increments.
 - ♦ Z presents different inlets, where "3" presents C14, "3A" presents C6.
- The EUT has the following several models with the rating as follows:

Model No.	Rating			Transformer	DC power cord
	AC I/P	DC O/P	WATT		
GT-41130-2012-2.0-T3, GT-41130-2012-2.0-T3A	100-240V, 0.8A, 50-60Hz	10V, 2A	20W	XF00592	Non-shielded DC (1.8m)
GT-41130-2012-T3, GT-41130-2012-T3A		12V, 2A	24W		
GT-41130-2024-9.0-T3, GT-41130-2024-9.0-T3A		15V, 1.6A		XF00599	Non-shielded DC (1.5m) with one ferrite core
GT-41130-2024-8.0-T3, GT-41130-2024-8.0-T3A		16V, 1.5A			Non-shielded DC (1.8m)
GT-41130-2024-T3, GT-41130-2024-T3A		24V, 1A	Non-shielded DC (1.5m) with one ferrite core		

3. During the test, **model: GT-41130-2012-2.0-T3, GT-41130-2012-T3, GT-41130-2024-9.0-T3, GT-41130-2024-8.0-T3, GT-41130-2024-T3** were selected as representative models and therefore only their test data were recorded in this report.
4. For a more detailed features description, please refer to the manufacturer's specifications or the User's Manual.

3.2 DESCRIPTION OF TEST MODES

During the test, the above models were pre-tested, and the worst emission level was found on **model no.: GT-41130-2024-9.0-T3**, and therefore the final test modes are as the following:

Test Item	Test Mode	Description of Test Mode	
		Model No.	Test Condition
Conducted Test	Mode 1	GT-41130-2012-T3	Full load
	Mode 2	GT-41130-2024-9.0-T3	
	Mode 3	GT-41130-2024-8.0-T3	
	Mode 4	GT-41130-2024-T3	
	Mode 5	GT-41130-2012-2.0-T3	
Radiated Test	Mode 1	GT-41130-2012-T3	
	Mode 2	GT-41130-2024-9.0-T3	
Harmonic / Flicker / Immunity Tests	Mode 1	GT-41130-2024-9.0-T3	

All above test modes were recorded in this report.

3.3 GENERAL DESCRIPTION OF APPLIED STANDARDS

The EUT is a Switching-Mode Power Supply, which are intended for sale to an end-users or installer. Therefore, according to the specifications of the manufacturers, must comply with the requirements of the following standards:

EN 61204-3: 2000, Class B

Emission:

CISPR 22: 1997, Class B

IEC 61000-3-2: 2005

IEC 61000-3-3: 2008

Immunity:

IEC 61000-4-2: 2008 ED.2.0

IEC 61000-4-3: 2006+A1: 2007 ED.3.0

IEC 61000-4-4: 2004 ED.2.0

IEC 61000-4-5: 2005 ED.2.0

IEC 61000-4-6: 2008 ED.3.0

IEC 61000-4-11: 2004 ED.2.0

EN 55022: 2006+A1: 2007, Class B

CISPR 22: 2005+A1: 2005, Class B

AS/NZS CISPR 22: 2006, Class B

EN 61000-3-2: 2006

EN 61000-3-3: 2008

EN 55024: 1998+A1: 2001+A2: 2003

IEC 61000-4-2: 2008 ED.2.0

IEC 61000-4-3: 2006+A1: 2007 ED.3.0

IEC 61000-4-4: 2004 ED.2.0

IEC 61000-4-5: 2005 ED.2.0

IEC 61000-4-6: 2008 ED.3.0

IEC 61000-4-8: 2009 ED.2.0

IEC 61000-4-11: 2004 ED.2.0

Notes: The above IEC basic standards are applied with latest version if customer has no special requirement

3.4 DESCRIPTION OF SUPPORT UNITS

The EUT has been tested as an independent unit together with other necessary accessories or support units. The following support units or accessories were used to form a representative test configuration during the tests.

3.4.1 FOR EMISSION TEST

NO.	PRODUCT	BRAND	MODEL NO.	SERIAL NO.	FCC ID
1	DUMMY LOAD	BVADT	L19B	L2-010029	N/A

NOTE: One non-shielded AC 3 Pin power cord (1.8m) was connected to EUT.

TEST CONFIGURATION <For Mode 1, Mode 3 & Mode 5>

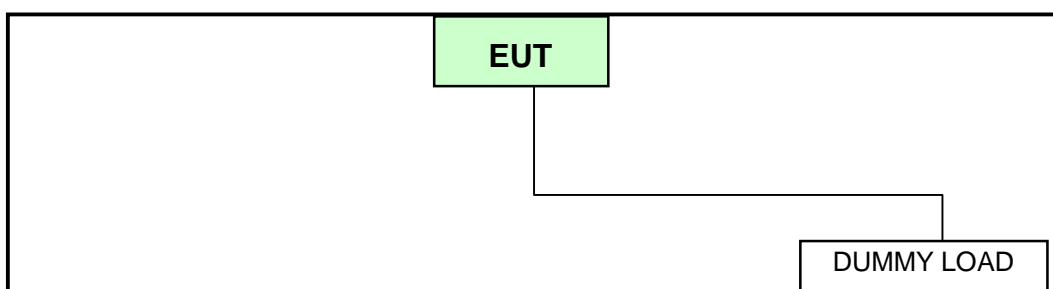

TEST CONFIGURATION <For Mode 2 & Mode 4>

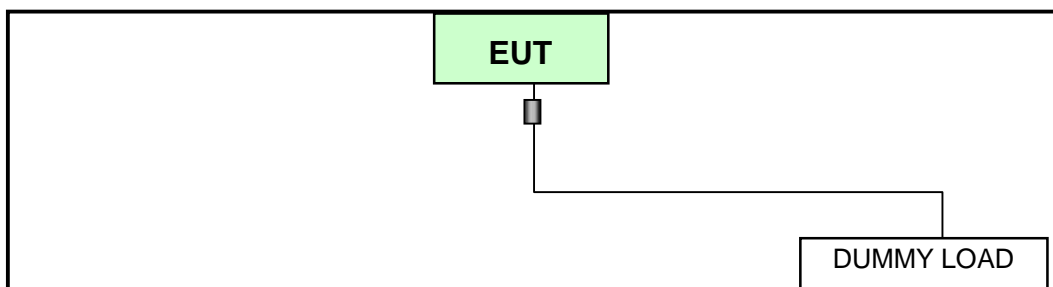

3.4.2 FOR HARMONICS, FLICKER & IMMUNITY TEST

NO.	PRODUCT	BRAND	MODEL NO.	SERIAL NO.	FCC ID
1	DUMMY LOAD	BVADT	L19B	L2-010029	N/A
2	Multimeter	YFE	YF-370A	N/A	N/A

NOTE: One non-shielded AC 3 Pin power cord (1.8m) was connected to EUT.

TEST CONFIGURATION – for Harmonic & Flicker Test

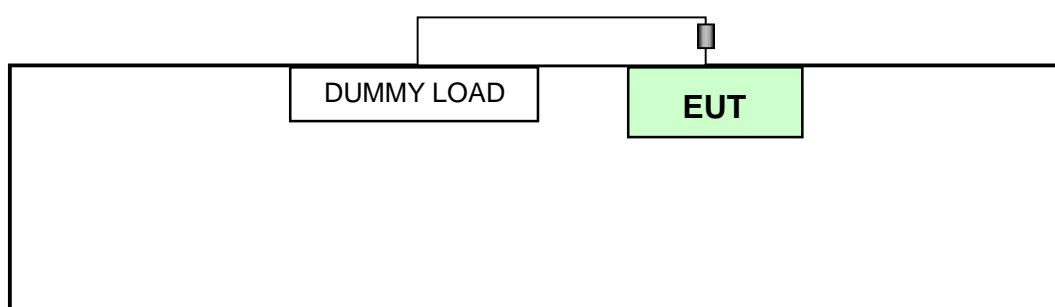

TEST CONFIGURATION – for Immunity Test

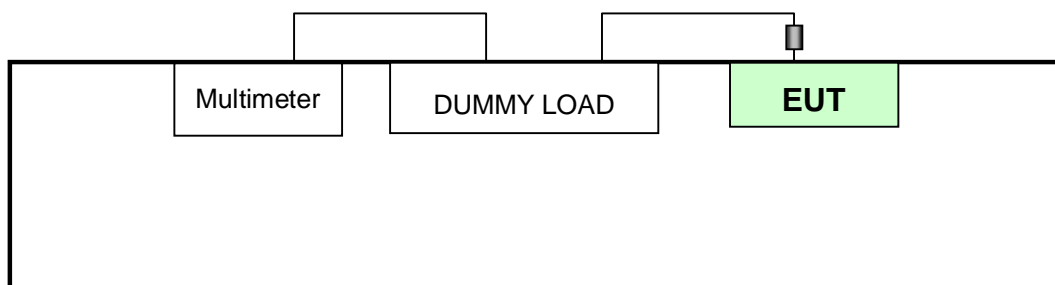

4 EMISSION TEST

4.1 CONDUCTED EMISSION MEASUREMENT

4.1.1 LIMITS OF CONDUCTED EMISSION MEASUREMENT

TEST STANDARD: EN 55022 / EN 61204-3

FREQUENCY (MHz)	Class A (dBuV)		Class B (dBuV)	
	Quasi-peak	Average	Quasi-peak	Average
0.15 - 0.5	79	66	66 - 56	56 - 46
0.50 - 5.0	73	60	56	46
5.0 - 30.0	73	60	60	50

- NOTE:**
- (1) The lower limit shall apply at the transition frequencies.
 - (2) The limit decreases in line with the logarithm of the frequency in the range of 0.15 to 0.50 MHz.
 - (3) All emanations from a class A/B digital device or system, including any network of conductors and apparatus connected thereto, shall not exceed the level of field strengths specified above.



A D T

4.1.2 TEST INSTRUMENTS

DESCRIPTION & MANUFACTURER	MODEL NO.	SERIAL NO.	CALIBRATED DATE	CALIBRATED UNTIL
ROHDE & SCHWARZ Test Receiver	ESCS 30	100292	Dec. 04, 2008	Dec. 03, 2009
ROHDE & SCHWARZ Artificial Mains Network (for EUT)	ESH3-Z5	835239/001	Feb. 24, 2009	Feb. 23, 2010
LISN With Adapter (for EUT)	AD10	C09Ada-001	Feb. 24, 2009	Feb. 23, 2010
ROHDE & SCHWARZ Artificial Mains Network (for EUT)	ESH2-Z5	100104	Dec. 04, 2008	Dec. 03, 2009
ROHDE & SCHWARZ Artificial Mains Network (for peripherals)	ESH3-Z5	835239/002	Mar. 09, 2009	Mar. 08, 2010
ROHDE & SCHWARZ Artificial Mains Network (for peripherals)	ESH3-Z5	100220	Nov. 05, 2008	Nov. 04, 2009
Software	ADT_Cond_V7.3.7	NA	NA	NA
Software	ADT_ISN_V7.3.7	NA	NA	NA
RF cable (JYEBAO)	5D-FB	Cable-C09.01	Feb. 26, 2009	Feb. 25, 2010
SUHNER Terminator (For ROHDE & SCHWARZ LISN)	65BNC-5001	E1-010789	May 15, 2009	May 14, 2010

- NOTE:**
1. The calibration interval of the above test instruments is 12 months and the calibrations are traceable to NML/ROC and NIST/USA.
 2. The test was performed in Shielded Room No. 9.
 3. The VCCI Site Registration No. C-1312.

4.1.3 TEST PROCEDURE

- a. The EUT was placed 0.4 meters from the conducting wall of the shielded room with EUT being connected to the power mains through a line impedance stabilization network (LISN). Other support units were connected to the power mains through another LISN. The two LISNs provide 50 Ohm/ 50uH of coupling impedance for the measuring instrument.
- b. Both lines of the power mains connected to the EUT were checked for maximum conducted interference.
- c. The frequency range from 150 kHz to 30 MHz was searched. Emission levels under (Limit -20dB) were not recorded.

4.1.4 DEVIATION FROM TEST STANDARD

No deviation

4.1.5 TEST SETUP

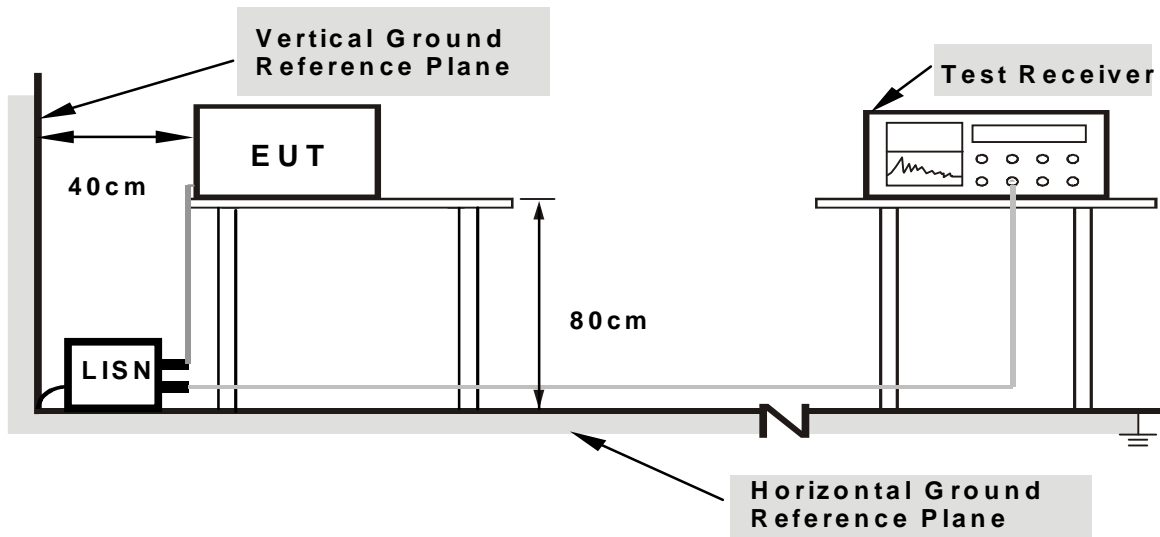

- Note:**
1. Support units were connected to second LISN.
 2. Both of LISNs (AMN) are 80cm from EUT and at least 80cm from other units and other metal planes support units.

For the actual test configuration, please refer to the related item – Photographs of the Test Configuration.

4.1.6 EUT OPERATING CONDITIONS

Set the EUT under full resistor load.



A D T

4.1.7 TEST RESULTS (1)

TEST MODE	Mode 1	6dB BANDWIDTH	9 kHz
INPUT POWER	230Vac, 50 Hz	PHASE	Line (L)
ENVIRONMENTAL CONDITIONS	26deg. C, 72% RH, 1010hPa	TESTED BY: Martin Lee	

No	Freq. [MHz]	Corr. Factor (dB)	Reading Value		Emission Level		Limit		Margin	
			[dB (uV)]		[dB (uV)]		[dB (uV)]		(dB)	
			Q.P.	AV.	Q.P.	AV.	Q.P.	AV.	Q.P.	AV.
1	0.158	0.19	57.39	23.35	57.58	23.54	65.58	55.58	-8.00	-32.04
2	0.185	0.22	56.01	32.21	56.23	32.43	64.25	54.25	-8.03	-21.83
3	0.293	0.23	50.53	26.49	50.76	26.72	60.44	50.44	-9.68	-23.72
4	0.373	0.24	46.99	-	47.23	-	58.44	48.44	-11.21	-
5	0.466	0.24	42.62	-	42.86	-	56.58	46.58	-13.71	-
6	0.545	0.25	43.54	-	43.79	-	56.00	46.00	-12.21	-
7	0.619	0.25	42.60	-	42.85	-	56.00	46.00	-13.15	-
8	0.713	0.26	44.61	-	44.87	-	56.00	46.00	-11.13	-
9	1.020	0.28	44.27	-	44.55	-	56.00	46.00	-11.45	-
10	1.883	0.32	41.99	-	42.31	-	56.00	46.00	-13.69	-
11	6.676	0.48	35.50	-	35.98	-	60.00	50.00	-24.02	-

- REMARKS:**
1. Q.P. and AV. are abbreviations of quasi-peak and average individually.
 2. "-": The Quasi-peak reading value also meets average limit and measurement with the average detector is unnecessary.
 3. The emission levels of other frequencies were very low against the limit.
 4. Margin value = Emission level - Limit value
 5. Correction factor = Insertion loss + Cable loss
 6. Emission Level = Correction Factor + Reading Value.

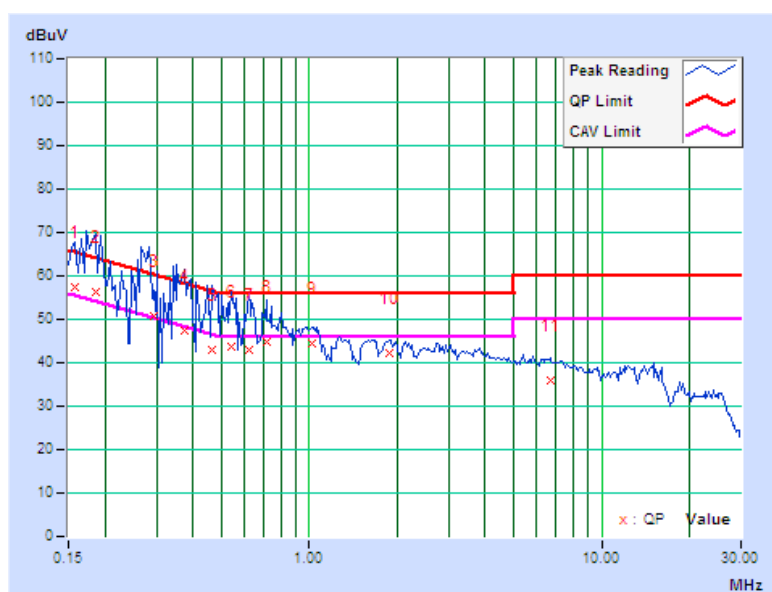



A D T

TEST MODE	Mode 1	6dB BANDWIDTH	9 kHz
INPUT POWER	230Vac, 50 Hz	PHASE	Neutral (N)
ENVIRONMENTAL CONDITIONS	26deg. C, 72% RH, 1010hPa	TESTED BY: Martin Lee	

No	Freq. [MHz]	Corr. Factor (dB)	Reading Value		Emission Level		Limit		Margin	
			[dB (uV)]		[dB (uV)]		[dB (uV)]		(dB)	
			Q.P.	AV.	Q.P.	AV.	Q.P.	AV.	Q.P.	AV.
1	0.173	0.22	56.65	30.95	56.87	31.17	64.79	54.79	-7.93	-23.63
2	0.205	0.25	55.07	21.60	55.32	21.85	63.42	53.42	-8.10	-31.57
3	0.267	0.25	50.89	-	51.14	-	61.20	51.20	-10.06	-
4	0.298	0.25	49.78	-	50.03	-	60.29	50.29	-10.25	-
5	0.349	0.26	47.47	-	47.73	-	58.98	48.98	-11.25	-
6	0.418	0.26	45.04	-	45.30	-	57.49	47.49	-12.19	-
7	0.470	0.26	42.60	-	42.86	-	56.51	46.51	-13.64	-
8	0.584	0.27	40.49	-	40.76	-	56.00	46.00	-15.24	-
9	0.834	0.29	41.13	-	41.42	-	56.00	46.00	-14.58	-
10	2.902	0.38	34.56	-	34.94	-	56.00	46.00	-21.06	-
11	15.051	0.83	35.54	-	36.37	-	60.00	50.00	-23.63	-

- REMARKS:**
1. Q.P. and AV. are abbreviations of quasi-peak and average individually.
 2. "-": The Quasi-peak reading value also meets average limit and measurement with the average detector is unnecessary.
 3. The emission levels of other frequencies were very low against the limit.
 4. Margin value = Emission level - Limit value
 5. Correction factor = Insertion loss + Cable loss
 6. Emission Level = Correction Factor + Reading Value.

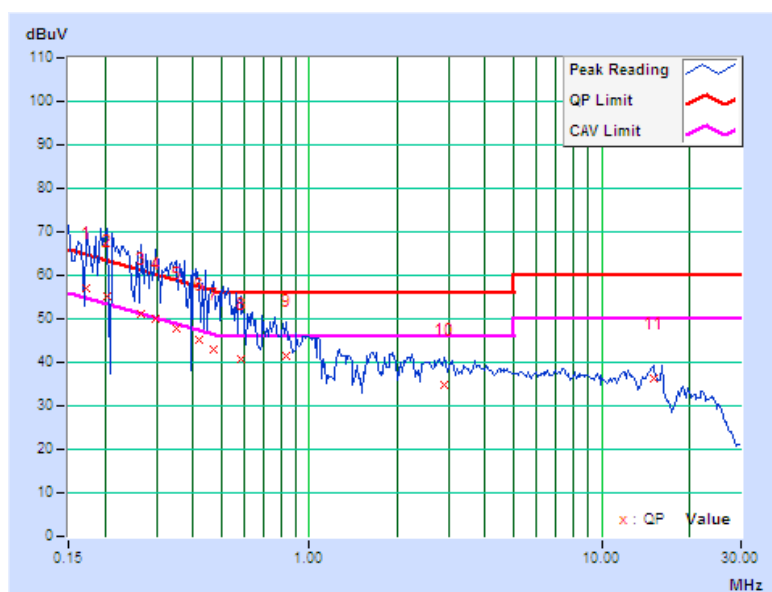



A D T

4.1.8 TEST RESULTS (2)

TEST MODE	Mode 2	6dB BANDWIDTH	9 kHz
INPUT POWER	230Vac, 50 Hz	PHASE	Line (L)
ENVIRONMENTAL CONDITIONS	26deg. C, 72% RH, 1010hPa	TESTED BY: Martin Lee	

No	Freq. [MHz]	Corr. Factor (dB)	Reading Value		Emission Level		Limit		Margin	
			[dB (uV)]		[dB (uV)]		[dB (uV)]		(dB)	
			Q.P.	AV.	Q.P.	AV.	Q.P.	AV.	Q.P.	AV.
1	0.180	0.21	61.27	49.28	61.48	49.49	64.50	54.50	-3.02	-5.01
2	0.189	0.22	60.17	46.48	60.39	46.70	64.08	54.08	-3.69	-7.38
3	0.216	0.23	55.15	25.00	55.38	25.23	62.96	52.96	-7.57	-27.72
4	0.240	0.23	56.83	41.40	57.06	41.63	62.10	52.10	-5.04	-10.47
5	0.298	0.23	53.48	36.49	53.71	36.72	60.29	50.29	-6.57	-13.56
6	0.361	0.24	51.16	36.15	51.40	36.39	58.71	48.71	-7.31	-12.32
7	0.423	0.24	51.63	37.52	51.87	37.76	57.38	47.38	-5.51	-9.62
8	0.513	0.25	49.60	31.89	49.85	32.14	56.00	46.00	-6.15	-13.86
9	0.783	0.27	50.23	35.39	50.50	35.66	56.00	46.00	-5.50	-10.34
10	1.055	0.28	50.91	38.32	51.19	38.60	56.00	46.00	-4.81	-7.40
11	1.402	0.30	50.43	39.03	50.73	39.33	56.00	46.00	-5.27	-6.67
12	1.785	0.32	48.20	35.97	48.52	36.29	56.00	46.00	-7.48	-9.71
13	3.102	0.37	49.01	40.21	49.38	40.58	56.00	46.00	-6.62	-5.42
14	7.102	0.49	44.78	-	45.27	-	60.00	50.00	-14.73	-

- REMARKS:**
1. Q.P. and AV. are abbreviations of quasi-peak and average individually.
 2. "-": The Quasi-peak reading value also meets average limit and measurement with the average detector is unnecessary.
 3. The emission levels of other frequencies were very low against the limit.
 4. Margin value = Emission level - Limit value
 5. Correction factor = Insertion loss + Cable loss
 6. Emission Level = Correction Factor + Reading Value.

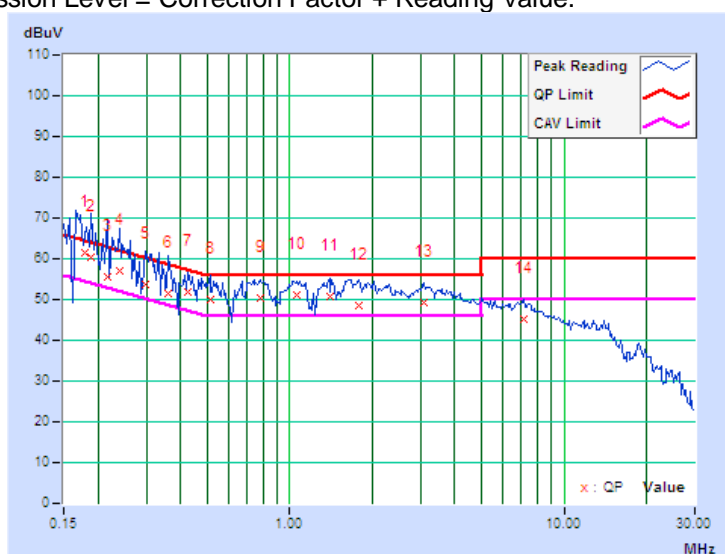



A D T

TEST MODE	Mode 2	6dB BANDWIDTH	9 kHz
INPUT POWER	230Vac, 50 Hz	PHASE	Neutral (N)
ENVIRONMENTAL CONDITIONS	26deg. C, 72% RH, 1010hPa	TESTED BY: Martin Lee	

No	Freq. [MHz]	Corr. Factor (dB)	Reading Value		Emission Level		Limit		Margin	
			[dB (uV)]		[dB (uV)]		[dB (uV)]		(dB)	
			Q.P.	AV.	Q.P.	AV.	Q.P.	AV.	Q.P.	AV.
1	0.181	0.23	57.62	41.84	57.85	42.07	64.43	54.43	-6.58	-12.36
2	0.205	0.25	52.92	-	53.17	-	63.42	53.42	-10.25	-
3	0.240	0.25	54.30	35.45	54.55	35.70	62.10	52.10	-7.55	-16.40
4	0.279	0.25	48.61	-	48.86	-	60.85	50.85	-11.98	-
5	0.392	0.26	43.65	-	43.91	-	58.02	48.02	-14.11	-
6	0.552	0.27	41.80	-	42.07	-	56.00	46.00	-13.93	-
7	0.787	0.29	44.05	-	44.34	-	56.00	46.00	-11.66	-
8	1.145	0.31	43.40	-	43.71	-	56.00	46.00	-12.29	-
9	1.660	0.33	44.67	-	45.00	-	56.00	46.00	-11.00	-
10	2.082	0.35	41.22	-	41.57	-	56.00	46.00	-14.43	-
11	3.609	0.41	41.49	-	41.90	-	56.00	46.00	-14.10	-
12	6.699	0.49	39.17	-	39.66	-	60.00	50.00	-20.34	-

- REMARKS:**
1. Q.P. and AV. are abbreviations of quasi-peak and average individually.
 2. "-": The Quasi-peak reading value also meets average limit and measurement with the average detector is unnecessary.
 3. The emission levels of other frequencies were very low against the limit.
 4. Margin value = Emission level - Limit value
 5. Correction factor = Insertion loss + Cable loss
 6. Emission Level = Correction Factor + Reading Value.

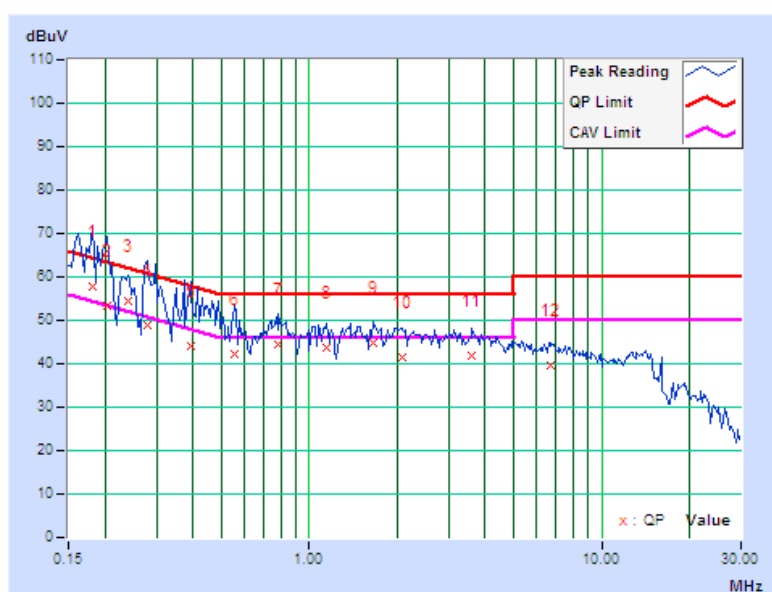



A D T

4.1.9 TEST RESULTS (3)

TEST MODE	Mode 3	6dB BANDWIDTH	9 kHz
INPUT POWER	230Vac, 50 Hz	PHASE	Line (L)
ENVIRONMENTAL CONDITIONS	26deg. C, 72% RH, 1010hPa	TESTED BY: Martin Lee	

No	Freq. [MHz]	Corr. Factor (dB)	Reading Value		Emission Level		Limit		Margin	
			[dB (uV)]		[dB (uV)]		[dB (uV)]		(dB)	
			Q.P.	AV.	Q.P.	AV.	Q.P.	AV.	Q.P.	AV.
1	0.187	0.22	61.32	49.90	61.54	50.12	64.16	54.16	-2.62	-4.04
2	0.209	0.23	57.02	26.38	57.25	26.61	63.26	53.26	-6.01	-26.65
3	0.244	0.23	57.76	43.00	57.99	43.23	61.95	51.95	-3.95	-8.71
4	0.373	0.24	52.39	36.68	52.63	36.92	58.44	48.44	-5.81	-11.52
5	0.447	0.24	52.48	37.12	52.72	37.36	56.93	46.93	-4.21	-9.57
6	0.771	0.26	52.08	38.61	52.34	38.87	56.00	46.00	-3.66	-7.13
7	1.039	0.28	50.45	36.63	50.73	36.91	56.00	46.00	-5.27	-9.09
8	1.375	0.30	50.52	38.26	50.82	38.56	56.00	46.00	-5.18	-7.44
9	1.609	0.31	50.50	37.66	50.81	37.97	56.00	46.00	-5.19	-8.03
10	2.027	0.33	47.88	37.83	48.21	38.16	56.00	46.00	-7.79	-7.84
11	3.199	0.37	46.83	38.37	47.20	38.74	56.00	46.00	-8.80	-7.26
12	6.375	0.47	44.73	-	45.20	-	60.00	50.00	-14.80	-

- REMARKS:**
1. Q.P. and AV. are abbreviations of quasi-peak and average individually.
 2. "-": The Quasi-peak reading value also meets average limit and measurement with the average detector is unnecessary.
 3. The emission levels of other frequencies were very low against the limit.
 4. Margin value = Emission level - Limit value
 5. Correction factor = Insertion loss + Cable loss
 6. Emission Level = Correction Factor + Reading Value.

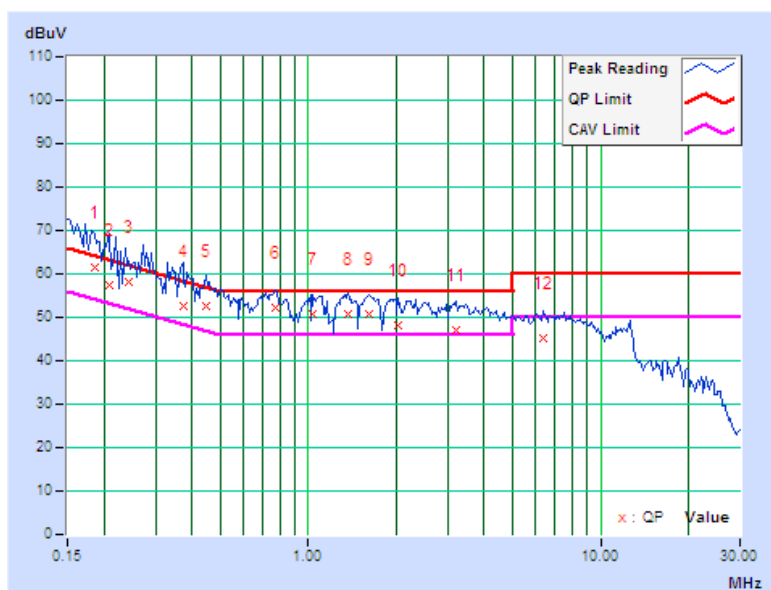



A D T

TEST MODE	Mode 3	6dB BANDWIDTH	9 kHz
INPUT POWER	230Vac, 50 Hz	PHASE	Neutral (N)
ENVIRONMENTAL CONDITIONS	26deg. C, 72% RH, 1010hPa	TESTED BY: Martin Lee	

No	Freq. [MHz]	Corr. Factor (dB)	Reading Value		Emission Level		Limit		Margin	
			[dB (uV)]		[dB (uV)]		[dB (uV)]		(dB)	
			Q.P.	AV.	Q.P.	AV.	Q.P.	AV.	Q.P.	AV.
1	0.184	0.23	58.17	42.53	58.40	42.76	64.28	54.28	-5.88	-11.52
2	0.192	0.24	58.63	40.48	58.87	40.72	63.96	53.96	-5.09	-13.24
3	0.238	0.25	55.56	35.89	55.81	36.14	62.15	52.15	-6.34	-16.01
4	0.309	0.26	50.38	31.87	50.64	32.13	59.98	49.98	-9.35	-17.86
5	0.377	0.26	48.84	32.61	49.10	32.87	58.35	48.35	-9.26	-15.49
6	0.494	0.27	45.85	30.75	46.12	31.02	56.10	46.10	-9.99	-15.09
7	0.591	0.27	42.17	-	42.44	-	56.00	46.00	-13.56	-
8	0.771	0.28	46.91	33.96	47.19	34.24	56.00	46.00	-8.81	-11.76
9	1.438	0.32	45.06	-	45.38	-	56.00	46.00	-10.62	-
10	2.262	0.36	43.00	-	43.36	-	56.00	46.00	-12.64	-
11	2.680	0.37	41.82	-	42.19	-	56.00	46.00	-13.81	-
12	6.836	0.50	40.98	-	41.48	-	60.00	50.00	-18.52	-

- REMARKS:**
1. Q.P. and AV. are abbreviations of quasi-peak and average individually.
 2. "-": The Quasi-peak reading value also meets average limit and measurement with the average detector is unnecessary.
 3. The emission levels of other frequencies were very low against the limit.
 4. Margin value = Emission level - Limit value
 5. Correction factor = Insertion loss + Cable loss
 6. Emission Level = Correction Factor + Reading Value.

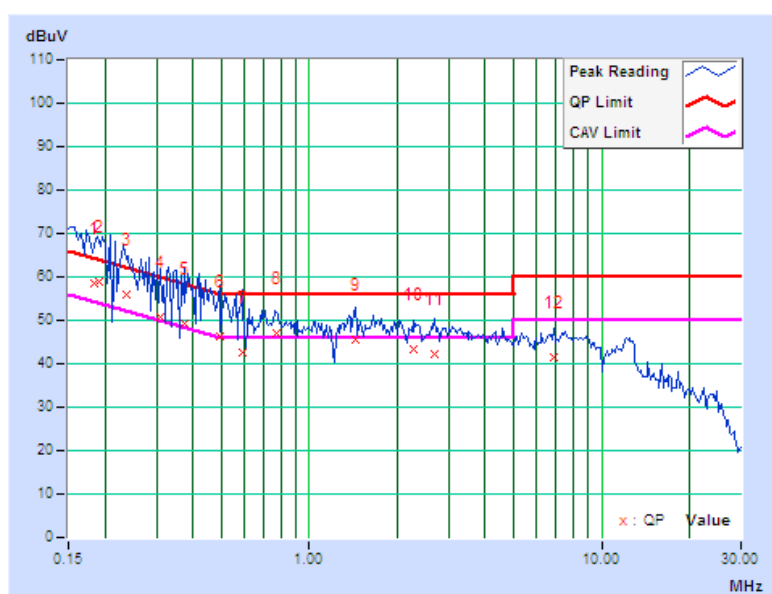



A D T

4.1.10 TEST RESULTS (4)

TEST MODE	Mode 4	6dB BANDWIDTH	9 kHz
INPUT POWER	230Vac, 50 Hz	PHASE	Line (L)
ENVIRONMENTAL CONDITIONS	26deg. C, 72% RH, 1010hPa	TESTED BY: Martin Lee	

No	Freq. [MHz]	Corr. Factor (dB)	Reading Value		Emission Level		Limit		Margin	
			[dB (uV)]		[dB (uV)]		[dB (uV)]		(dB)	
			Q.P.	AV.	Q.P.	AV.	Q.P.	AV.	Q.P.	AV.
1	0.176	0.21	59.42	46.12	59.63	46.33	64.67	54.67	-5.05	-8.35
2	0.252	0.23	57.24	40.60	57.47	40.83	61.71	51.71	-4.23	-10.87
3	0.361	0.24	53.15	36.61	53.39	36.85	58.71	48.71	-5.32	-11.86
4	0.490	0.25	53.59	39.26	53.84	39.51	56.17	46.17	-2.33	-6.66
5	0.720	0.26	49.46	33.89	49.72	34.15	56.00	46.00	-6.28	-11.85
6	1.074	0.28	51.07	38.08	51.35	38.36	56.00	46.00	-4.65	-7.64
7	1.633	0.31	50.04	37.81	50.35	38.12	56.00	46.00	-5.65	-7.88
8	2.867	0.36	47.79	38.27	48.15	38.63	56.00	46.00	-7.85	-7.37
9	7.004	0.49	44.39	-	44.88	-	60.00	50.00	-15.12	-

- REMARKS:**
1. Q.P. and AV. are abbreviations of quasi-peak and average individually.
 2. "-": The Quasi-peak reading value also meets average limit and measurement with the average detector is unnecessary.
 3. The emission levels of other frequencies were very low against the limit.
 4. Margin value = Emission level - Limit value
 5. Correction factor = Insertion loss + Cable loss
 6. Emission Level = Correction Factor + Reading Value.

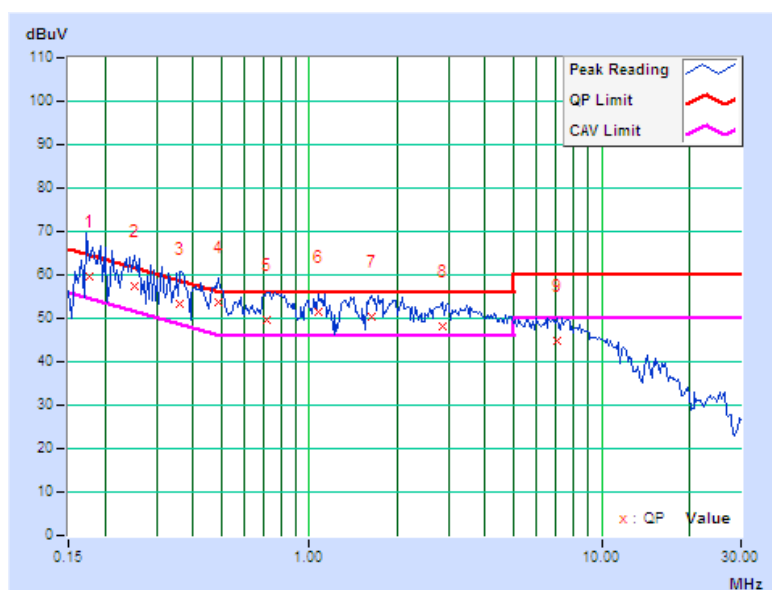



A D T

TEST MODE	Mode 4	6dB BANDWIDTH	9 kHz
INPUT POWER	230Vac, 50 Hz	PHASE	Neutral (N)
ENVIRONMENTAL CONDITIONS	26deg. C, 72% RH, 1010hPa	TESTED BY: Martin Lee	

No	Freq. [MHz]	Corr. Factor (dB)	Reading Value		Emission Level		Limit		Margin	
			[dB (uV)]		[dB (uV)]		[dB (uV)]		(dB)	
			Q.P.	AV.	Q.P.	AV.	Q.P.	AV.	Q.P.	AV.
1	0.180	0.23	56.98	44.28	57.21	44.51	64.50	54.50	-7.30	-10.00
2	0.236	0.25	57.20	37.82	57.45	38.07	62.24	52.24	-4.79	-14.17
3	0.365	0.26	51.73	31.96	51.99	32.22	58.62	48.62	-6.63	-16.40
4	0.490	0.27	49.81	35.17	50.08	35.44	56.17	46.17	-6.09	-10.73
5	0.634	0.28	43.32	-	43.60	-	56.00	46.00	-12.40	-
6	0.728	0.28	46.23	30.61	46.51	30.89	56.00	46.00	-9.49	-15.11
7	1.211	0.31	43.53	-	43.84	-	56.00	46.00	-12.16	-
8	1.641	0.33	44.31	-	44.64	-	56.00	46.00	-11.36	-
9	2.691	0.37	42.96	-	43.33	-	56.00	46.00	-12.67	-
10	6.641	0.49	40.18	-	40.67	-	60.00	50.00	-19.33	-

- REMARKS:**
1. Q.P. and AV. are abbreviations of quasi-peak and average individually.
 2. "-": The Quasi-peak reading value also meets average limit and measurement with the average detector is unnecessary.
 3. The emission levels of other frequencies were very low against the limit.
 4. Margin value = Emission level - Limit value
 5. Correction factor = Insertion loss + Cable loss
 6. Emission Level = Correction Factor + Reading Value.

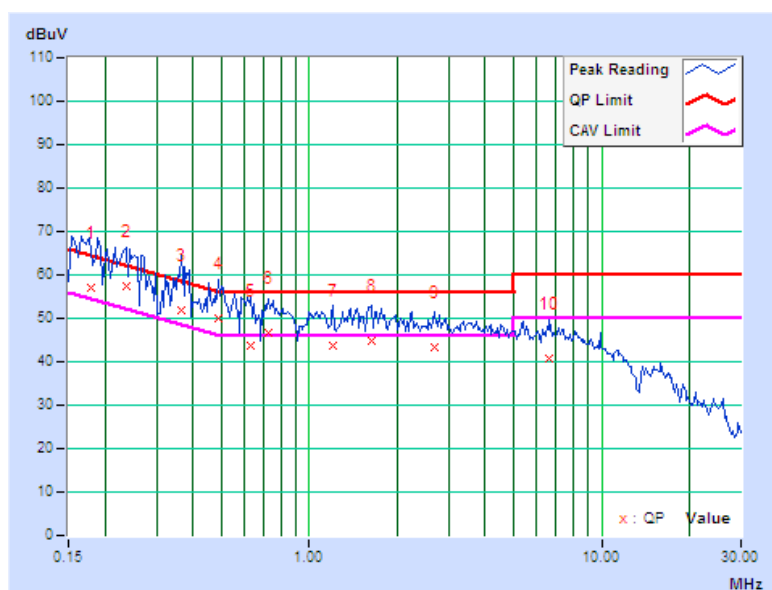



A D T

4.1.11 TEST RESULTS (5)

TEST MODE	Mode 5	6dB BANDWIDTH	9 kHz
INPUT POWER	230Vac, 50 Hz	PHASE	Line (L)
ENVIRONMENTAL CONDITIONS	25deg. C, 70% RH, 1009hPa	TESTED BY: Ian Chang	

No	Freq. [MHz]	Corr. Factor (dB)	Reading Value		Emission Level		Limit		Margin	
			[dB (uV)]		[dB (uV)]		[dB (uV)]		(dB)	
			Q.P.	AV.	Q.P.	AV.	Q.P.	AV.	Q.P.	AV.
1	0.150	0.18	56.77	22.57	56.95	22.75	66.00	56.00	-9.05	-33.25
2	0.193	0.22	54.74	24.81	54.96	25.03	63.91	53.91	-8.94	-28.87
3	0.255	0.23	50.73	-	50.96	-	61.58	51.58	-10.61	-
4	0.306	0.24	48.30	-	48.54	-	60.07	50.07	-11.54	-
5	0.402	0.24	45.34	-	45.58	-	57.81	47.81	-12.23	-
6	0.474	0.24	47.14	32.27	47.38	32.51	56.44	46.44	-9.05	-13.92
7	0.630	0.26	40.46	-	40.72	-	56.00	46.00	-15.28	-
8	1.074	0.28	43.98	-	44.26	-	56.00	46.00	-11.74	-
9	1.762	0.32	42.95	-	43.27	-	56.00	46.00	-12.73	-
10	2.934	0.36	39.76	-	40.12	-	56.00	46.00	-15.88	-
11	16.008	0.96	40.00	-	40.96	-	60.00	50.00	-19.04	-

- REMARKS:**
1. Q.P. and AV. are abbreviations of quasi-peak and average individually.
 2. "-": The Quasi-peak reading value also meets average limit and measurement with the average detector is unnecessary.
 3. The emission levels of other frequencies were very low against the limit.
 4. Margin value = Emission level - Limit value
 5. Correction factor = Insertion loss + Cable loss
 6. Emission Level = Correction Factor + Reading Value.

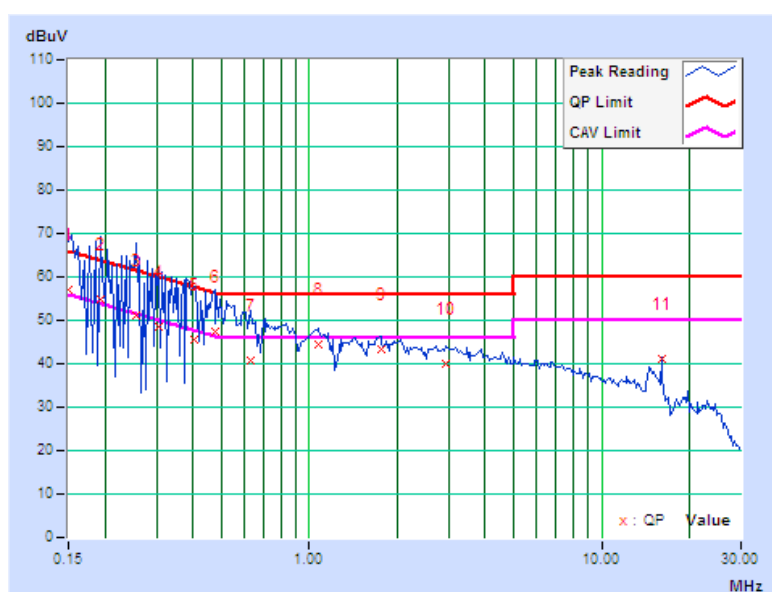



A D T

TEST MODE	Mode 5	6dB BANDWIDTH	9 kHz
INPUT POWER	230Vac, 50 Hz	PHASE	Neutral (N)
ENVIRONMENTAL CONDITIONS	25deg. C, 70% RH, 1009hPa	TESTED BY: Ian Chang	

No	Freq. [MHz]	Corr. Factor (dB)	Reading Value		Emission Level		Limit		Margin	
			[dB (uV)]		[dB (uV)]		[dB (uV)]		(dB)	
			Q.P.	AV.	Q.P.	AV.	Q.P.	AV.	Q.P.	AV.
1	0.150	0.19	57.19	22.86	57.38	23.05	66.00	56.00	-8.62	-32.95
2	0.176	0.22	56.50	29.06	56.72	29.28	64.67	54.67	-7.95	-25.39
3	0.236	0.25	52.23	29.56	52.48	29.81	62.25	52.25	-9.77	-22.44
4	0.306	0.26	49.39	-	49.65	-	60.07	50.07	-10.43	-
5	0.423	0.26	43.08	-	43.34	-	57.38	47.38	-14.04	-
6	0.502	0.27	44.08	-	44.35	-	56.00	46.00	-11.65	-
7	0.970	0.30	36.48	-	36.78	-	56.00	46.00	-19.22	-
8	2.063	0.35	36.12	-	36.47	-	56.00	46.00	-19.53	-
9	16.063	0.86	33.62	-	34.48	-	60.00	50.00	-25.52	-

- REMARKS:**
1. Q.P. and AV. are abbreviations of quasi-peak and average individually.
 2. "-": The Quasi-peak reading value also meets average limit and measurement with the average detector is unnecessary.
 3. The emission levels of other frequencies were very low against the limit.
 4. Margin value = Emission level - Limit value
 5. Correction factor = Insertion loss + Cable loss
 6. Emission Level = Correction Factor + Reading Value.

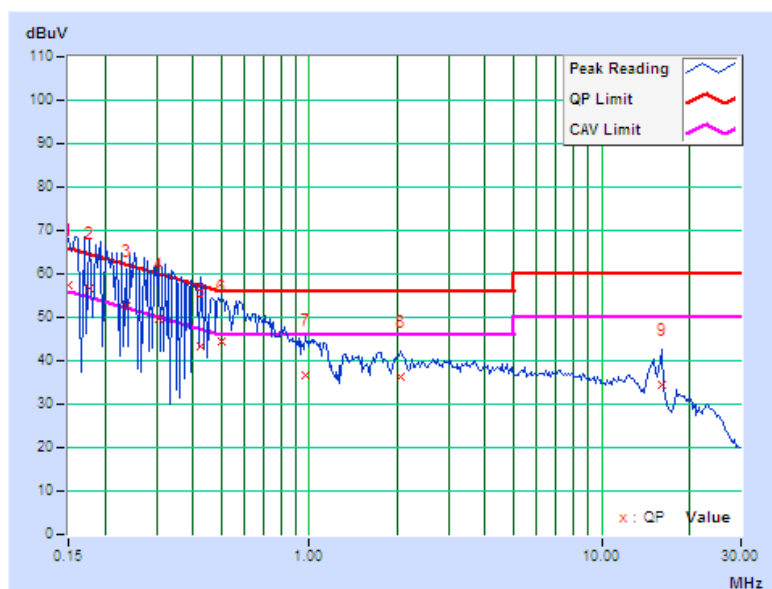

4.2 RADIATED EMISSION MEASUREMENT

4.2.1 LIMITS OF RADIATED EMISSION MEASUREMENT

TEST STANDARD: EN 55022 / EN 61204-3

FOR FREQUENCY BELOW 1000 MHz

FREQUENCY (MHz)	Class A (at 10m)	Class B (at 10m)
	dBuV/m	dBuV/m
30 – 230	40	30
230 – 1000	47	37

TEST STANDARD: EN 55022

FOR FREQUENCY ABOVE 1000 MHz

FREQUENCY (GHz)	Class A (dBuV/m) (at 3m)		Class B (dBuV/m) (at 3m)	
	PEAK	AVERAGE	PEAK	AVERAGE
1 to 3	76	56	70	50
3 to 6	80	60	74	54

- NOTE:** (1) The lower limit shall apply at the transition frequencies.
 (2) Emission level (dBuV/m) = 20 log Emission level (uV/m).
 (3) All emanation from a class A/B digital device or system, including any network of conductors and apparatus connected thereto, shall not exceed the level of field strengths specified above.

FREQUENCY RANGE OF RADIATED MEASUREMENT (For unintentional radiators)

Highest frequency generated or Upper frequency of measurement used in the device or on which the device operates or tunes (MHz)	Range (MHz)
Below 108	1000
108 – 500	2000
500 – 1000	5000
Above 1000	Up to 5 times of the highest frequency or 6 GHz, whichever is less



A D T

4.2.2 TEST INSTRUMENTS

DESCRIPTION & MANUFACTURER	MODEL NO.	SERIAL NO.	CALIBRATED DATE	CALIBRATED UNTIL
Agilent Preamplifier	8447D	2944A11062	Sep. 03, 2009	Sep. 02, 2010
Agilent Preamplifier	8447D	2944A11064	Sep. 03, 2009	Sep. 02, 2010
Agilent Test Spectrum	E4443A	MY46182050	Jul. 02, 2009	Jul. 01, 2010
Agilent Test Spectrum	E4443A	MY46182049	Jul. 07, 2009	Jul. 06, 2010
Agilent Test Preselector	N9039A	MY46520284	Jul. 02, 2009	Jul. 01, 2010
Agilent Test Preselector	N9039A	MY46520283	Jul. 07, 2009	Jul. 06, 2010
Agilent Signal Generator	N5181A	MY47421329	Jul. 02, 2009	Jul. 01, 2010
Schwarzbeck Antenna	VULB9168	9168-316	Apr. 30, 2009	Apr. 29, 2010
Schwarzbeck Antenna	VULB9168	9168-317	Apr. 30, 2009	Apr. 29, 2010
Max Full. Turn Table & Tower	MF7802	MF7802121	NA	NA
Max Full. Tower	MF7802	MF780208105	NA	NA
Software	ADT_Radiated_V8.7.03.5	NA	NA	NA
WOKEN RF cable	8D	CABLE-CH8-01.V	Dec. 24, 2008	Dec. 23, 2009
WOKEN RF cable	8D	CABLE-CH8-02.H	Dec. 24, 2008	Dec. 23, 2009
WOKEN RF cable	8D	CABLE-CH8-03.3M	Dec. 24, 2008	Dec. 23, 2009

- NOTE:** 1. The calibration interval of the above test instruments is 12 months. And the calibrations are traceable to NML/ROC and NIST/USA.
2. The test was performed in Chamber No. 8.
3. The Industry Canada Reference No. IC 7450E-8.
4. The VCCI Site Registration No. R-2946
5. The FCC Site Registration No. 493821.

4.2.3 TEST PROCEDURE

- a. The EUT was placed on the top of a rotating table 0.8 meters above the ground at a 10 meter Semi-anechoic chamber room. The table was rotated 360 degrees to determine the position of the highest radiation.
- b. The EUT was set 10 meters away from the interference-receiving antenna, which was mounted on the top of a variable-height antenna tower.
- c. The height of antenna is varied from one meter to four meters above the ground to determine the maximum value of the field strength. Both horizontal and vertical polarizations of the antenna are set to make the measurement.
- d. For each suspected emission, the EUT was arranged to its worst case and then the antenna was tuned to heights from 1 meter to 4 meters and the rotatable table was turned from 0 degrees to 360 degrees to find the maximum reading.
- e. The test-receiver system was set to quasi-peak detect function and specified bandwidth with maximum hold mode when the test frequency is below 1 GHz.
- f. The test-receiver system was set to peak and average detect function and specified bandwidth with maximum hold mode when the test frequency is above 1 GHz.

NOTE:

1. The resolution bandwidth of test receiver/spectrum analyzer is 120kHz for Quasi-peak detection (QP) at frequency below 1GHz.
2. The resolution bandwidth is 1MHz and video bandwidth of test receiver/spectrum analyzer is 3MHz for Peak detection at frequency above 1GHz. The resolution bandwidth of test receiver/spectrum analyzer is 1 MHz for Average detection (AV) at frequency above 1GHz.
3. For measurement of frequency above 1000 MHz, the EUT was set 3 meters away from the receiver antenna.

4.2.4 DEVIATION FROM TEST STANDARD

No deviation

4.2.5 TEST SETUP

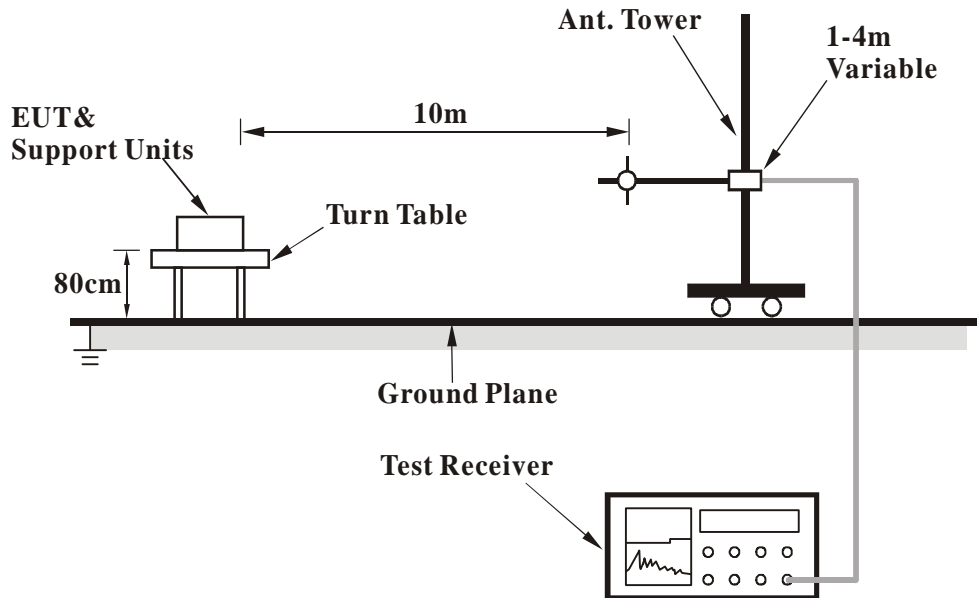

For the actual test configuration, please refer to the related item – Photographs of the Test Configuration.

4.2.6 EUT OPERATING CONDITIONS

Same as item 4.1.6.



A D T

4.2.7 TEST RESULTS (1)

TEST MODE	Mode 1	FREQUENCY RANGE	30-1000 MHz
INPUT POWER	230Vac, 50 Hz	DETECTOR FUNCTION & BANDWIDTH	Quasi-Peak, 120kHz
ENVIRONMENTAL CONDITIONS	25deg. C, 71% RH, 1010hPa	TESTED BY: Ian Chang	

ANTENNA POLARITY & TEST DISTANCE: HORIZONTAL AT 10 M

No.	Freq. (MHz)	Emission Level (dBuV/m)	Limit (dBuV/m)	Margin (dB)	Antenna Height (m)	Table Angle (Degree)	Raw Value (dBuV)	Correction Factor (dB/m)
1	39.71	14.28 QP	30.00	-15.72	4.00 H	26	0.47	13.81
2	47.76	14.46 QP	30.00	-15.54	4.00 H	184	1.16	13.30
3	105.20	10.56 QP	30.00	-19.44	4.00 H	194	0.27	10.29
4	146.43	22.39 QP	30.00	-7.61	4.00 H	169	8.08	14.31
5	164.17	19.98 QP	30.00	-10.02	4.00 H	174	5.76	14.23
6	184.42	15.27 QP	30.00	-14.73	4.00 H	166	2.66	12.61

- REMARKS:**
1. Emission level(dBuV/m)=Raw Value(dBuV) + Correction Factor(dB/m)
 2. Correction Factor(dB/m) = Antenna Factor (dB/m) + Cable Factor (dB)
 3. The other emission levels were very low against the limit.
 4. Margin value = Emission level – Limit value.

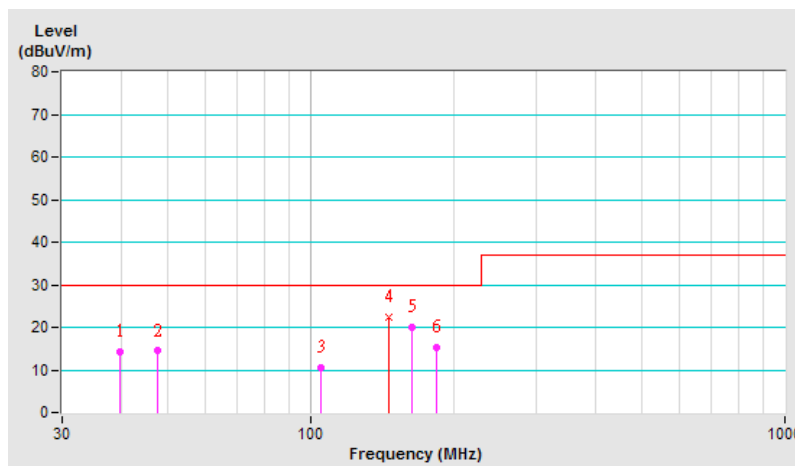



A D T

TEST MODE	Mode 1	FREQUENCY RANGE	30-1000 MHz
INPUT POWER	230Vac, 50 Hz	DETECTOR FUNCTION & BANDWIDTH	Quasi-Peak, 120kHz
ENVIRONMENTAL CONDITIONS	25deg. C, 71% RH, 1010hPa	TESTED BY: Ian Chang	

ANTENNA POLARITY & TEST DISTANCE: VERTICAL AT 10 M								
No.	Freq. (MHz)	Emission Level (dBuV/m)	Limit (dBuV/m)	Margin (dB)	Antenna Height (m)	Table Angle (Degree)	Raw Value (dBuV)	Correction Factor (dB/m)
1	47.88	18.51 QP	30.00	-11.49	1.00 V	210	5.28	13.22
2	66.47	18.31 QP	30.00	-11.69	1.00 V	117	5.98	12.33
3	82.11	16.47 QP	30.00	-13.53	1.00 V	165	6.88	9.59
4	90.16	15.41 QP	30.00	-14.59	1.00 V	13	6.43	8.98
5	147.59	20.32 QP	30.00	-9.68	1.00 V	108	6.10	14.22
6	166.54	15.31 QP	30.00	-14.69	1.00 V	92	1.39	13.92

- REMARKS:**
1. Emission level(dBuV/m)=Raw Value(dBuV) + Correction Factor(dB/m)
 2. Correction Factor(dB/m) = Antenna Factor (dB/m) + Cable Factor (dB)
 3. The other emission levels were very low against the limit.
 4. Margin value = Emission level – Limit value.

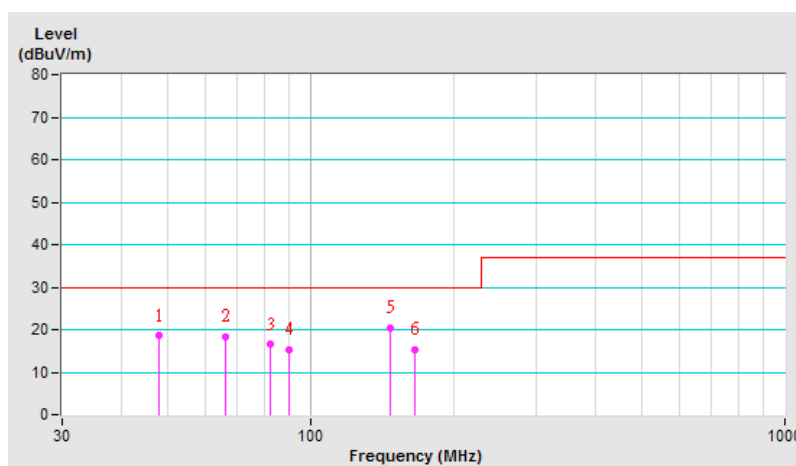



A D T

4.2.8 TEST RESULTS (2)

TEST MODE	Mode 2	FREQUENCY RANGE	30-1000 MHz
INPUT POWER	230Vac, 50 Hz	DETECTOR FUNCTION & BANDWIDTH	Quasi-Peak, 120kHz
ENVIRONMENTAL CONDITIONS	25deg. C, 71% RH, 1010hPa	TESTED BY: Ian Chang	

ANTENNA POLARITY & TEST DISTANCE: HORIZONTAL AT 10 M

No.	Freq. (MHz)	Emission Level (dBuV/m)	Limit (dBuV/m)	Margin (dB)	Antenna Height (m)	Table Angle (Degree)	Raw Value (dBuV)	Correction Factor (dB/m)
1	65.29	17.13 QP	30.00	-12.87	4.00 H	138	4.52	12.62
2	81.28	17.39 QP	30.00	-12.61	4.00 H	121	7.67	9.72
3	87.67	15.37 QP	30.00	-14.63	4.00 H	306	6.28	9.09
4	129.95	14.04 QP	30.00	-15.96	4.00 H	58	1.27	12.76
5	161.92	17.20 QP	30.00	-12.80	4.00 H	71	2.84	14.36
6	200.88	22.04 QP	30.00	-7.96	4.00 H	80	10.57	11.47

- REMARKS:**
1. Emission level(dBuV/m)=Raw Value(dBuV) + Correction Factor(dB/m)
 2. Correction Factor(dB/m) = Antenna Factor (dB/m) + Cable Factor (dB)
 3. The other emission levels were very low against the limit.
 4. Margin value = Emission level – Limit value.

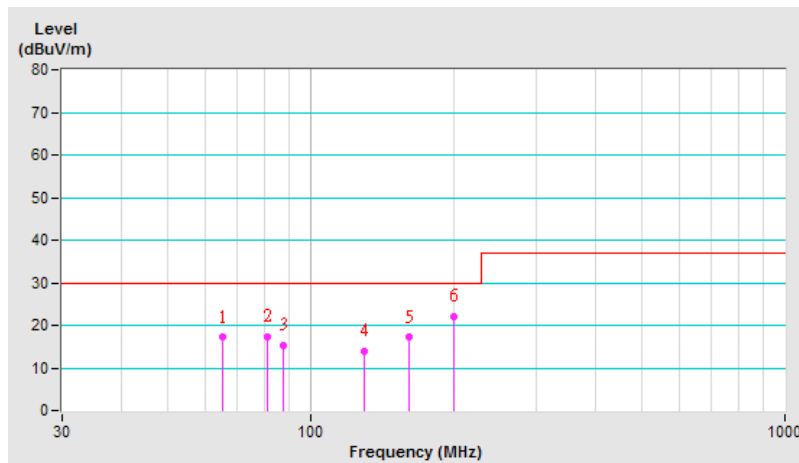



A D T

TEST MODE	Mode 2	FREQUENCY RANGE	30-1000 MHz
INPUT POWER	230Vac, 50 Hz	DETECTOR FUNCTION & BANDWIDTH	Quasi-Peak, 120kHz
ENVIRONMENTAL CONDITIONS	25deg. C, 71% RH, 1010hPa	TESTED BY: Ian Chang	

ANTENNA POLARITY & TEST DISTANCE: VERTICAL AT 10 M								
No.	Freq. (MHz)	Emission Level (dBuV/m)	Limit (dBuV/m)	Margin (dB)	Antenna Height (m)	Table Angle (Degree)	Raw Value (dBuV)	Correction Factor (dB/m)
1	48.36	17.79 QP	30.00	-12.21	1.00 V	153	4.65	13.14
2	65.65	23.91 QP	30.00	-6.09	1.00 V	61	11.53	12.38
3	82.82	22.62 QP	30.00	-7.38	1.00 V	180	13.09	9.54
4	88.50	22.90 QP	30.00	-7.10	1.00 V	65	13.82	9.09
5	191.53	20.68 QP	30.00	-9.32	1.00 V	81	8.81	11.87
6	199.32	22.86 QP	30.00	-7.14	1.00 V	67	11.57	11.28

- REMARKS:**
1. Emission level(dBuV/m)=Raw Value(dBuV) + Correction Factor(dB/m)
 2. Correction Factor(dB/m) = Antenna Factor (dB/m) + Cable Factor (dB)
 3. The other emission levels were very low against the limit.
 4. Margin value = Emission level – Limit value.

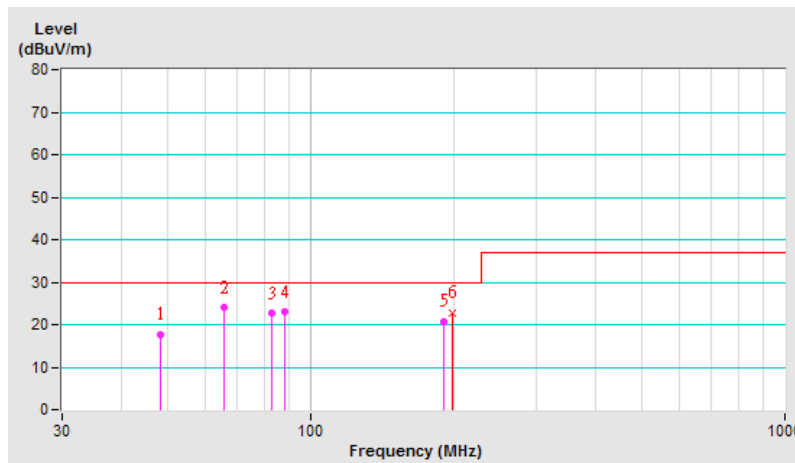

4.3 HARMONICS CURRENT MEASUREMENT

4.3.1 LIMITS OF HARMONICS CURRENT MEASUREMENT

TEST STANDARD: IEC 61000-3-2 / EN 61000-3-2

Limits for Class A equipment		Limits for Class D equipment		
Harmonics Order n	Max. permissible harmonics current A	Harmonics Order n	Max. permissible harmonics current per watt mAW	Max. permissible harmonics current A
Odd harmonics		Odd Harmonics only		
3	2.30	3	3.4	2.30
5	1.14	5	1.9	1.14
7	0.77	7	1.0	0.77
9	0.40	9	0.5	0.40
11	0.33	11	0.35	0.33
13	0.21	13	0.30	0.21
15<=n<=39	0.15x15/n	15<=n<=39	3.85/n	0.15x15/n
Even harmonics				
2	1.08			
4	0.43			
6	0.30			
8<=n<=40	0.23x8/n			

NOTE: 1. Class A and Class D are classified according to section 5 of IEC 61000-3-2: 2005/ EN 61000-3-2:2006.

2. According to section 7 of IEC 61000-3-2: 2005/ EN 61000-3-2: 2006, the above limits for all equipment except for lighting equipment are for all applications having an active input power > 75 W and no limits apply for equipment with an active input power up to and including 75 W.

4.3.2 TEST INSTRUMENTS

DESCRIPTION & MANUFACTURER	MODEL NO.	SERIAL NO.	CALIBRATED DATE	CALIBRATED UNTIL
EMC PARTNER EMC Emission Tester	HAR1000-1P	084	Apr. 22, 2009	Apr. 21, 2010
Software	HARCS	NA	NA	NA

NOTE: 1. The test was performed in EMS Room No. 1.

2. The calibration interval of the above test instruments is 12 months and the calibrations are traceable to NML/ROC and NIST/USA.

3. According to IEC 61000-4-7: 2002, the time window shall be synchronized with each group of 10 or 12 cycles (200 ms) for power frequency of 50 or 60Hz.

4.3.3 TEST PROCEDURE

- a. The EUT was placed on the top of a wooden table 0.8 meters above the ground and operated to produce the maximum harmonic components under normal operating conditions for each successive harmonic component in turn.
- b. The classification of EUT is according to section 5 of IEC 61000-3-2: 2005/ EN 61000-3-2: 2006.

The EUT is classified as follows:

Class A: Balanced three-phase equipment, Household appliances excluding equipment as Class D, Tools excluding portable tools, Dimmers for incandescent lamps, audio equipment, equipment not specified in one of the three other classes.

Class B: Portable tools. ; Arc welding equipment which is not professional equipment

Class C: Lighting equipment.

Class D: Equipment having a specified power less than or equal to 600 W of the following types: Personal computers and personal computer monitors and television receivers.

- c. The correspondent test program of test instrument to measure the current harmonics emanated from EUT is chosen. The measure time shall be not less than the time necessary for the EUT to be exercised.

4.3.4 DEVIATION FROM TEST STANDARD

No deviation

4.3.5 TEST SETUP

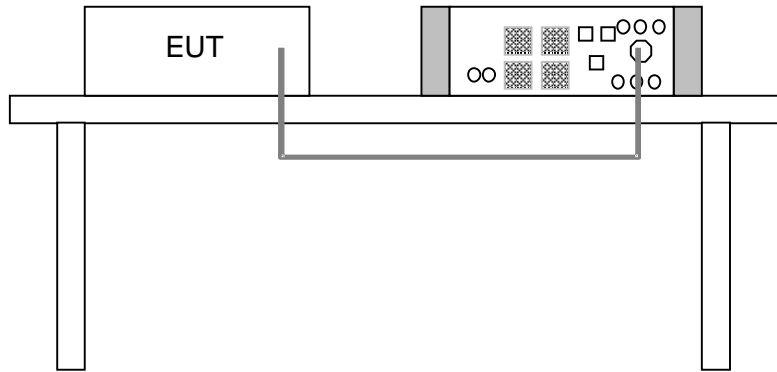

For the actual test configuration, please refer to the related item – Photographs of the Test Configuration.

4.3.6 EUT OPERATING CONDITIONS

Connected resistor load to DC output port of EUT to make EUT have maximum power consumption.

4.3.7 TEST RESULTS

TEST MODE	Mode 1		
FUNDAMENTAL VOLTAGE/AMPERE	230.1 Vrms/ 0.302 Arms	POWER FREQUENCY	49.987 Hz
POWER CONSUMPTION	29.06W	POWER FACTOR	0.418
ENVIRONMENTAL CONDITIONS	25 deg. C, 68% RH, 1010 hPa	TESTED BY: Brian Chen	

NOTE: Limits are not specified for equipment with a rated power of 75W or less (other than lighting equipment).

4.4 VOLTAGE FLUCTUATION AND FLICKS MEASUREMENT

4.4.1 LIMITS OF VOLTAGE FLUCTUATION AND FLICKS MEASUREMENT

TEST STANDARD: IEC 61000-3-3 / EN 61000-3-3

TEST ITEM	LIMIT	NOTE
P_{st}	1.0	P_{st} means short-term flicker indicator.
P_{lt}	0.65	P_{lt} means long-term flicker indicator.
$T_{d(t)}$ (ms)	500	$T_{d(t)}$ means maximum time that $d(t)$ exceeds 3.3%.
d_{max} (%)	4	d_{max} means maximum relative voltage change.
dc (%)	3.3	dc means relative steady-state voltage change

4.4.2 TEST INSTRUMENTS

DESCRIPTION & MANUFACTURER	MODEL NO.	SERIAL NO.	CALIBRATED DATE	CALIBRATED UNTIL
EMC PARTNER EMC Emission Tester	HAR1000-1P	084	Apr. 22, 2009	Apr. 21, 2010
Software	HARCS	NA	NA	NA

NOTE: 1. The test was performed in EMS Room No. 1.
2. The calibration interval of the above test instruments is 12 months and the calibrations are traceable to NML/ROC and NIST/USA.

4.4.3 TEST PROCEDURE

- a. The EUT was placed on the top of a wooden table 0.8 meters above the ground and operated to produce the most unfavorable sequence of voltage changes under normal operating conditions.
- b. During the flick measurement, the measure time shall include that part of whole operation cycle in which the EUT produce the most unfavorable sequence of voltage changes. The observation period for short-term flicker indicator is 10 minutes and the observation period for long-term flicker indicator is 2 hours.

4.4.4 DEVIATION FROM TEST STANDARD

No deviation

4.4.5 TEST SETUP

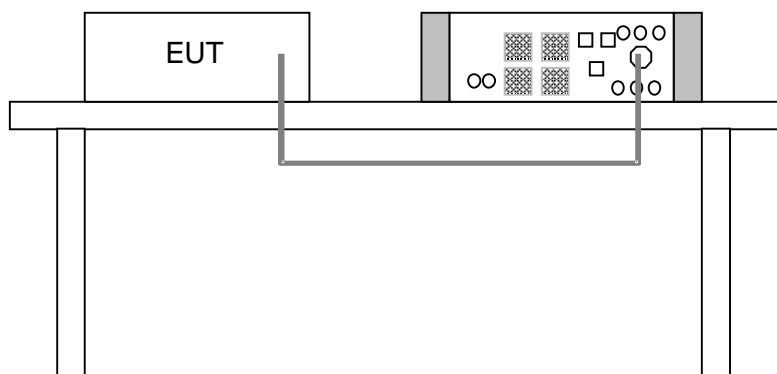

For the actual test configuration, please refer to the related item – Photographs of the Test Configuration.

4.4.6 EUT OPERATING CONDITIONS

Same as item 4.3.6



A D T

4.4.7 TEST RESULTS

TEST MODE	Mode 1		
FUNDAMENTAL VOLTAGE/AMPERE	230.1 Vrms/ 0.302 Arms	POWER FREQUENCY	49.987 Hz
OBSERVATOPM PERIOD (Tp)	10 min	POWER FACTOR	0.418
ENVIRONMENTAL CONDITIONS	25 deg. C, 68% RH, 1010 hPa	TESTED BY: Brian Chen	

TEST PARAMETER	MEASUREMENT VALUE	LIMIT	REMARKS
P _{st}	0.072	1.0	Pass
P _{lt}	0.072	0.65	Pass
T _{d(t)} (ms)	0	500	Pass
d _{max} (%)	0	4	Pass
dc (%)	0.010	3.3	Pass

- NOTE:**
- (1) P_{st} means short-term flicker indicator.
 - (2) P_{lt} means long-term flicker indicator.
 - (3) T_{d(t)} means maximum time that d(t) exceeds 3.3%.
 - (4) d_{max} means maximum relative voltage change.
 - (5) dc means relative steady-state voltage change.

5 IMMUNITY TEST

5.1 GENERAL DESCRIPTION

Product Standard:	EN 61204-3: 2000	
Basic Standard, specification requirement, and Performance Criteria:	IEC 61000-4-2	Electrostatic Discharge – ESD: 8kV air discharge, 4kV Contact discharge, Performance Criterion B
	IEC 61000-4-3	Radio-Frequency Electromagnetic Field Amplitude modulated – RS: 80-1000 MHz, 3V/m, 80% AM (1kHz), Performance Criterion B
		Radio-Frequency Electromagnetic Field, Keyed carrier: 900+/-5 MHz, 3V/m, 50 % duty cycle, Rep. Frequency 200 Hz, Performance Criterion B
	IEC 61000-4-4	Electrical Fast Transient/Burst - EFT, Power line: 1kV, Signal line: 0.5kV, Performance Criterion B
	IEC 61000-4-5	Surge Immunity Test: 1.2/50 us Open Circuit Voltage, 8 /20 us Short Circuit Current, line to line: 1kV, line to earth: 2kV, Performance Criterion B
	IEC 61000-4-6	Conducted Radio Frequency Disturbances Test – CS: 0.15-80 MHz, 3Vrms, 80% AM, 1kHz, Performance Criterion B
	IEC 61000-4-11	Voltage Dips: i) 30% reduction – 10ms, Performance Criterion B ii) 60% reduction – 100ms, Performance Criterion C
Voltage Interruptions: i) >95% reduction – 5000ms, Performance Criterion C		

5.2 GENERAL PERFORMANCE CRITERIA DESCRIPTION

According to Clause 6.1 of EN 61204-3: 2000 standard, the following describes the general performance criteria.

Performance Criteria	Basic specifications	Remarks
A	No loss of function or performance during the test	Operating as intended within specified tolerance
B	Temporary loss of function or performance during the test Self recoverable	Degradation of performance shall be specified by the manufacturer PSU shall continue to operate as intended after the test
C	Loss of function or performance Not self-recoverable Not damaged	Any re-settable condition allowed including shut-down

According to EN 55024: 1998 +A1: 2001+A2: 2003 standard, the following describes the general performance criteria.

CRITERION A	The equipment shall continue to operate as intended without operator intervention. No degradation of performance or loss of function is allowed below a performance level specified by the manufacturer when the equipment is used as intended. The performance level may be replaced by a permissible loss of performance. If the minimum performance level or the permissible performance loss is not specified by the manufacturer, then either of these may be derived from the product description and documentation, and by what the user may reasonably expect from the equipment if used as intended.
CRITERION B	<p>After the test, the equipment shall continue to operate as intended without operator intervention. No degradation of performance or loss of function is allowed, after the application of the phenomenon below a performance level specified by the manufacturer, when the equipment is used as intended. The performance level may be replaced by a permissible loss of performance.</p> <p>During the test, degradation of performance is allowed. However, no change of operating state if stored data is allowed to persist after the test. If the minimum performance level (or the permissible performance loss) is not specified by the manufacturer, then either of these may be derived from the product description and documentation, and by what the user may reasonably expect from the equipment if used as intended.</p>
CRITERION C	<p>Loss of function is allowed, provided the function is self-recoverable, or can be restored by the operation of the controls by the user in accordance with the manufacturer's instructions.</p> <p>Functions, and/or information stored in non-volatile memory, or protected by a battery backup, shall not be lost.</p>

5.3 EUT OPERATING CONDITION

Connected a resistor load to DC output port of EUT to make EUT have maximum power consumption and a multimeter was used to monitor voltage of output.

5.4 ELECTROSTATIC DISCHARGE IMMUNITY TEST (ESD)

5.4.1 TEST SPECIFICATION

Basic Standard:	IEC 61000-4-2
Discharge Impedance:	330 ohm / 150 pF
Discharge Voltage:	Air Discharge: 2kV/ 4kV/ 8kV (Direct) Contact Discharge: 2kV/ 4kV (Indirect)
Polarity:	Positive & Negative
Number of Discharge:	For EN 55024: Air Discharge: min. 20 times at each test point Contact Discharge: min. 200 times in total For EN 61204-3: 20 times at each test point
Discharge Mode:	Single Discharge
Discharge Period:	1 second minimum

5.4.2 TEST INSTRUMENTS

DESCRIPTION & MANUFACTURER	MODEL NO.	SERIAL NO.	CALIBRATED DATE	CALIBRATED UNTIL
KeyTek, ESD Simulator	MZ-15/EC	0504259	May 25, 2009	May 24, 2010

- NOTE:** 1. The test was performed in ESD Room No. 1.
2. The calibration interval of the above test instruments is 12 months and the calibrations are traceable to NML/ROC and NIST/USA.

5.4.3 TEST PROCEDURE

The discharges shall be applied in two ways: <For EN 55024>

a. Contact discharges to the conductive surfaces and coupling planes:

The EUT shall be exposed to at least 200 discharges, 100 each at negative and positive polarity, at a minimum of four test points. One of the test points shall be subjected to at least 50 indirect discharges to the center of the front edge of the horizontal coupling plane. The remaining three test points shall each receive at least 50 direct contact discharges. If no direct contact test points are available, then at least 200 indirect discharges shall be applied in the indirect mode. Test shall be performed at a maximum repetition rate of one discharge per second.

b. Air discharges at slots and apertures and insulating surfaces:

On those parts of the EUT where it is not possible to perform contact discharge testing, the equipment should be investigated to identify user accessible points where breakdown may occur. Such points are tested using the air discharge method. This investigation should be restricted to those area normally handled by the user. A minimum of 10 single air discharges shall be applied to the selected test point for each such area.

The basic test procedure was in accordance with IEC 61000-4-2:

- a. Electrostatic discharges were applied only to those points and surfaces of the EUT that are accessible to users during normal operation.
- b. The test was performed with at least ten single discharges on the pre-selected points in the most sensitive polarity.
- c. The time interval between two successive single discharges was at least 1 second.
- d. The ESD generator was held perpendicularly to the surface to which the discharge was applied and the return cable was at least 0.2 meters from the EUT.
- e. Contact discharges were applied to the non-insulating coating, with the pointed tip of the generator penetrating the coating and contacting the conducting substrate.
- f. Air discharges were applied with the round discharge tip of the discharge electrode approaching the EUT as fast as possible (without causing mechanical damage) to touch the EUT. After each discharge, the ESD generator was removed from the EUT and re-triggered for a new single discharge. The test was repeated until all discharges were complete.
- g. At least ten single discharges (in the most sensitive polarity) were applied to the **Horizontal Coupling Plane** at points on each side of the EUT. The ESD generator was positioned horizontally at a distance of 0.1 meters from the EUT with the discharge electrode touching the **HCP**.
- h. At least ten single discharges (in the most sensitive polarity) were applied to the center of one vertical edge of the **Vertical Coupling Plane** in sufficiently different positions that the four faces of the EUT were completely illuminated. The **VCP** (dimensions 0.5m x 0.5m) was placed vertically to and 0.1 meters from the EUT.

5.4.4 DEVIATION FROM TEST STANDARD

No deviation

5.4.5 TEST SETUP

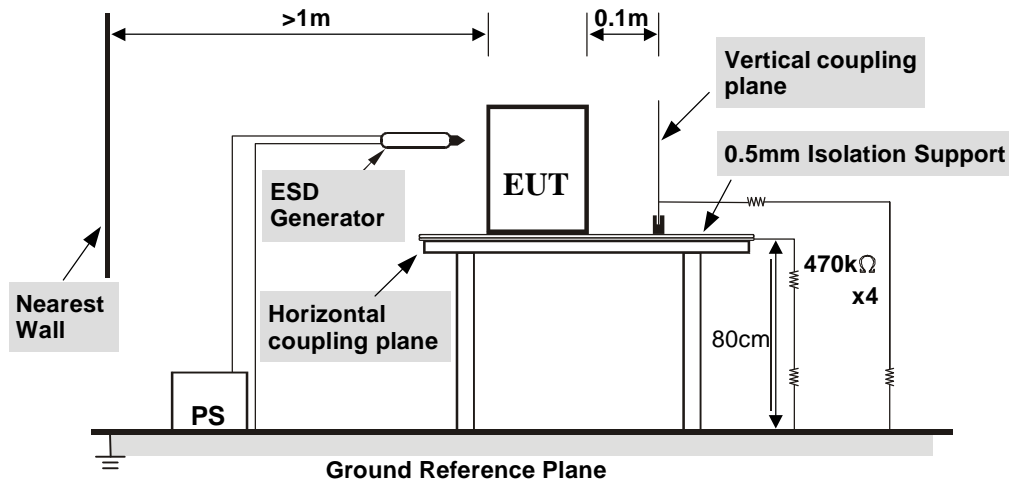

For the actual test configuration, please refer to the related item – Photographs of the Test Configuration.

NOTE:

TABLE-TOP EQUIPMENT

The configuration consisted of a wooden table 0.8 meters high standing on the **Ground Reference Plane**. The **GRP** consisted of a sheet of aluminum at least 0.25mm thick, and 2.5 meters square connected to the protective grounding system. A **Horizontal Coupling Plane** (1.6m x 0.8m) was placed on the table and attached to the **GRP** by means of a cable with 940kΩ total impedance. The equipment under test, was installed in a representative system as described in section 7 of IEC 61000-4-2, and its cables were placed on the **HCP** and isolated by an insulating support of 0.5mm thickness. A distance of 1-meter minimum was provided between the EUT and the walls of the laboratory and any other metallic structure.

FLOOR-STANDING EQUIPMENT

The equipment under test was installed in a representative system as described in section 7 of IEC 61000-4-2, and its cables were isolated from the Ground Reference Plane by an insulating support of 0.1-meter thickness. The GRP consisted of a sheet of aluminum that is at least 0.25mm thick, and 2.5 meters square connected to the protective grounding system and extended at least 0.5 meters from the EUT on all sides.

5.4.6 TEST RESULTS

TEST MODE	Mode 1	INPUT POWER	230Vac, 50 Hz
ENVIRONMENTAL CONDITIONS	26 deg. C, 53% RH, 1009 hPa	TESTED BY: Brian Chen	

TEST RESULTS OF DIRECT APPLICATION					
Discharge Level (kV)	Polarity	Test Point	Contact Discharge	Air Discharge	Performance Criterion
2, 4, 8	+/-	1 ~ 3	N/A	Note	A

Description of test point: Please refer to ESD test photo for representative mark only.

TEST RESULTS OF INDIRECT APPLICATION					
Discharge Level (kV)	Polarity	Test Point	Horizontal Coupling Plane	Vertical Coupling Plane	Performance Criterion
2, 4	+/-	1 ~ 4	Note	Note	A

Description of test point:

1. Left side
2. Right side
3. Front side
4. Rear side

NOTE: There was no change compared with initial operation during the test.

5.5 RADIATED, RADIO-FREQUENCY, ELECTROMAGNETIC FIELD IMMUNITY TEST (RS)

5.5.1 TEST SPECIFICATION

Basic Standard:	IEC 61000-4-3
Frequency Range:	80 MHz - 1000 MHz
Field Strength:	3 V/m
Modulation:	1 kHz Sine Wave, 80%, AM Modulation
Frequency Step:	1 % of fundamental
Polarity of Antenna:	Horizontal and Vertical
Antenna Height:	1.5 m
Dwell Time:	3 seconds



5.5.2 TEST INSTRUMENTS

DESCRIPTION & MANUFACTURER	MODEL NO.	SERIAL NO.	CALIBRATED DATE	CALIBRATED UNTIL
Agilent Signal Generator	E8257D	MY48050465	Jun. 05, 2009	Jun. 04, 2010
PRANA RF Amplifier	AP32DP280	0811-894	NA	NA
AR RF Amplifier	150W1000M3	306601	NA	NA
AR RF Amplifier	35S4G8AM4	0326094	NA	NA
AR RF Amplifier	100S1G4M3	0329249	NA	NA
AR Controller	SC1000M3	305910	NA	NA
Radisense Electric Field Sensor	CTR1001A	06D00232SN0-02	Sep. 02, 2009	Sep. 01, 2010
Radisense Electric Field Sensor	CTR1002A	08D00016SN O-09	Aug. 27, 2009	Aug. 26, 2010
BOONTON RF Voltage Meter	4232A	10180	Jun. 04, 2009	Jun. 03, 2010
BOONTON Power Sensor	51011-EMC	34152	Jun. 04, 2009	Jun. 03, 2010
BOONTON Power Sensor	51011-EMC	34153	Jun. 04, 2009	Jun. 03, 2010
AR Log-Periodic Antenna	AT6080	0329465	NA	NA
EMCO BiconiLog Antenna	3141	1001	NA	NA
AR High Gain Antenna	AT4002A	306533	NA	NA
AR High Gain Horn Antenna	AT4010	0329800	NA	NA
CHANCE MOST Full Anechoic Chamber (9x5x3m)	Chance Most	RS-002	Feb. 25, 2009	Feb. 24, 2010
Software	ADT_RS_V7.6	NA	NA	NA

- NOTE:** 1. The test was performed in RS Room No.2.
 2. The calibration interval of the above test instruments is 12 months and the calibrations are traceable to NML/ROC and NIST/USA.
 3. The transmit antenna was located at a distance of 3.5 meters from the EUT.

5.5.3 TEST PROCEDURE

The test procedure was in accordance with IEC 61000-4-3

- a. The testing was performed in a fully-anechoic chamber.
- b. The frequency range is swept from 80 MHz to 1000 MHz with the signal 80% amplitude modulated with a 1kHz sine wave.
- c. The dwell time at each frequency shall not be less than the time necessary for the EUT to be exercised and to respond, but shall in no case be less than 0,5s.
- d. The field strength level was 3V/m.
- e. The test was performed with the EUT exposed to both vertically and horizontally polarized fields on each of the four sides.

5.5.4 DEVIATION FROM TEST STANDARD

No deviation

5.5.5 TEST SETUP

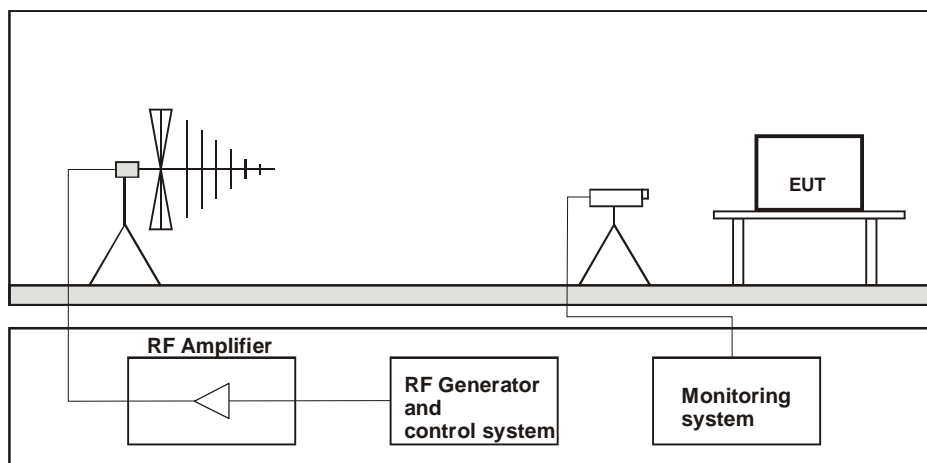

For the actual test configuration, please refer to the related item – Photographs of the Test Configuration.

NOTE:

TABLETOP EQUIPMENT

The EUT installed in a representative system as described in section 7 of IEC 61000-4-3 was placed on a non-conductive table 0.8 meters in height. The system under test was connected to the power and signal wire according to relevant installation instructions.

FLOOR STANDING EQUIPMENT

The EUT installed in a representative system as described in section 7 of IEC 61000-4-3 was placed on a non-conductive wood support 0.1 meters in height. The system under test was connected to the power and signal wire according to relevant installation instructions.

5.5.6 TEST RESULTS

TEST MODE	Mode 1	INPUT POWER	230Vac, 50 Hz
ENVIRONMENTAL CONDITIONS	26 deg. C, 68% RH, 1008 hPa	TESTED BY: Thomas Cheng	

Frequency (MHz)	Polarity	Azimuth	Field Strength (V/m)	Observation	Performance Criterion
80 – 1000	V&H	0	3	Note	A
	V&H	90	3		
	V&H	180	3		
	V&H	270	3		

NOTE: There was no change compared with initial operation during the test.

5.6 RADIO-FREQUENCY ELECTROMAGNETIC FIELD – KEYED CARRIER TEST

5.6.1 TEST SPECIFICATION

Basic Standard:	IEC 61000-4-3
Frequency Range:	895 MHz - 905 MHz
Field Strength:	3 V/m
Modulation:	Pulse 200 Hz, 50% Duty Cycle
Frequency Step:	1 MHz
Polarity of Antenna:	Horizontal and Vertical
Antenna Height:	1.5 m
Dwell Time:	3 seconds



A D T

5.6.2 TEST INSTRUMENTS

DESCRIPTION & MANUFACTURER	MODEL NO.	SERIAL NO.	CALIBRATED DATE	CALIBRATED UNTIL
Agilent Signal Generator	E8257D	MY48050465	Jun. 05, 2009	Jun. 04, 2010
PRANA RF Amplifier	AP32DP280	0811-894	NA	NA
AR RF Amplifier	150W1000M3	306601	NA	NA
AR RF Amplifier	35S4G8AM4	0326094	NA	NA
AR RF Amplifier	100S1G4M3	0329249	NA	NA
AR Controller	SC1000M3	305910	NA	NA
Radisense Electric Field Sensor	CTR1001A	06D00232SN0-02	Sep. 02, 2009	Sep. 01, 2010
Radisense Electric Field Sensor	CTR1002A	08D00016SN O-09	Aug. 27, 2009	Aug. 26, 2010
BOONTON RF Voltage Meter	4232A	10180	Jun. 04, 2009	Jun. 03, 2010
BOONTON Power Sensor	51011-EMC	34152	Jun. 04, 2009	Jun. 03, 2010
BOONTON Power Sensor	51011-EMC	34153	Jun. 04, 2009	Jun. 03, 2010
AR Log-Periodic Antenna	AT6080	0329465	NA	NA
EMCO BiconiLog Antenna	3141	1001	NA	NA
AR High Gain Antenna	AT4002A	306533	NA	NA
AR High Gain Horn Antenna	AT4010	0329800	NA	NA
CHANCE MOST Full Anechoic Chamber (9x5x3m)	Chance Most	RS-002	Feb. 25, 2009	Feb. 24, 2010
Software	ADT_RS_V7.6	NA	NA	NA

- NOTE:** 1. The test was performed in RS Room No.2.
2. The calibration interval of the above test instruments is 12 months and the calibrations are traceable to NML/ROC and NIST/USA.
3. The transmit antenna was located at a distance of 3.5 meters from the EUT.

5.6.3 TEST PROCEDURE

The test procedure was in accordance with IEC 61000-4-3

- a. The testing was performed in a fully-anechoic chamber.
- b. The frequency range was from 895 MHz to 905 MHz. The test spot frequencies with keying capability were at 200 Hz, 50 % duty cycle.
- c. The dwell time at each frequency shall be not less than the time necessary for the EUT to be able to respond, but shall in no case be less than 0,5s.
- d. The field strength level was 3V/m.
- e. The test was performed with the EUT exposed to both vertically and horizontally polarized fields on each of the four sides.

5.6.4 DEVIATION FROM TEST STANDARD

No deviation

5.6.5 TEST SETUP

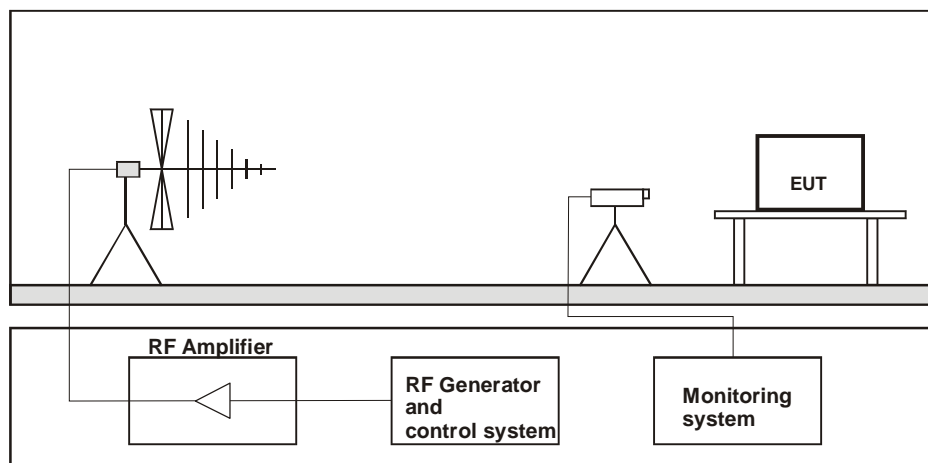

For the actual test configuration, please refer to the related item – Photographs of the Test Configuration.

NOTE:

TABLETOP EQUIPMENT

The EUT installed in a representative system as described in section 7 of IEC 61000-4-3 was placed on a non-conductive table 0.8 meters in height. The system under test was connected to the power and signal wire according to relevant installation instructions.

FLOOR STANDING EQUIPMENT

The EUT installed in a representative system as described in section 7 of IEC 61000-4-3 was placed on a non-conductive wood support 0.1 meters in height. The system under test was connected to the power and signal wire according to relevant installation instructions.

5.6.6 TEST RESULTS

TEST MODE	Mode 1	INPUT POWER	230 Vac, 50 Hz
ENVIRONMENTAL CONDITIONS	26 deg. C, 68% RH, 1008 hPa	TESTED BY: Thomas Cheng	

Frequency (MHz)	Polarity	Azimuth	Field Strength (V/m)	Observation	Performance Criterion
895 -905	V & H	0	3	Note	A
	V & H	90	3	Note	A
	V & H	180	3	Note	A
	V & H	270	3	Note	A

NOTE: There was no change compared with initial operation during the test.

5.7 ELECTRICAL FAST TRANSIENT/BURST IMMUNITY TEST (EFT)

5.7.1 TEST SPECIFICATION

Basic Standard:	IEC 61000-4-4
Test Voltage:	Power Line: 1 kV Signal/Control Line: N/A
Polarity:	Positive & Negative
Impulse Frequency:	5 kHz
Impulse Waveshape :	5/50 ns
Burst Duration:	15 ms
Burst Period:	300 ms
Test Duration:	1 min.

5.7.2 TEST INSTRUMENTS

DESCRIPTION & MANUFACTURER	MODEL NO.	SERIAL NO.	CALIBRATED DATE	CALIBRATED UNTIL
Haefely, EFT Generator	PEFT 4010	154954	Mar. 12, 2009	Mar. 11, 2010
Haefely, Capacitive Clamp	IP4A	155173	NA	NA

- NOTE:** 1. The test was performed in EFT Room
 2. The calibration interval of the above test instruments is 12 months and the calibrations are traceable to NML/ROC and NIST/USA.

5.7.3 TEST PROEDURE

- Both positive and negative polarity discharges were applied.
- The length of the “hot wire” from the coaxial output of the EFT generator to the terminals on the EUT should not exceed 0.5 meter \pm 0.05 meter.
- The duration time of each test sequential was 1 minute.
- The transient/burst waveform was in accordance with IEC 61000-4-4, 5/50ns.

5.7.4 DEVIATION FROM TEST STANDARD

No deviation

5.7.5 TEST SETUP

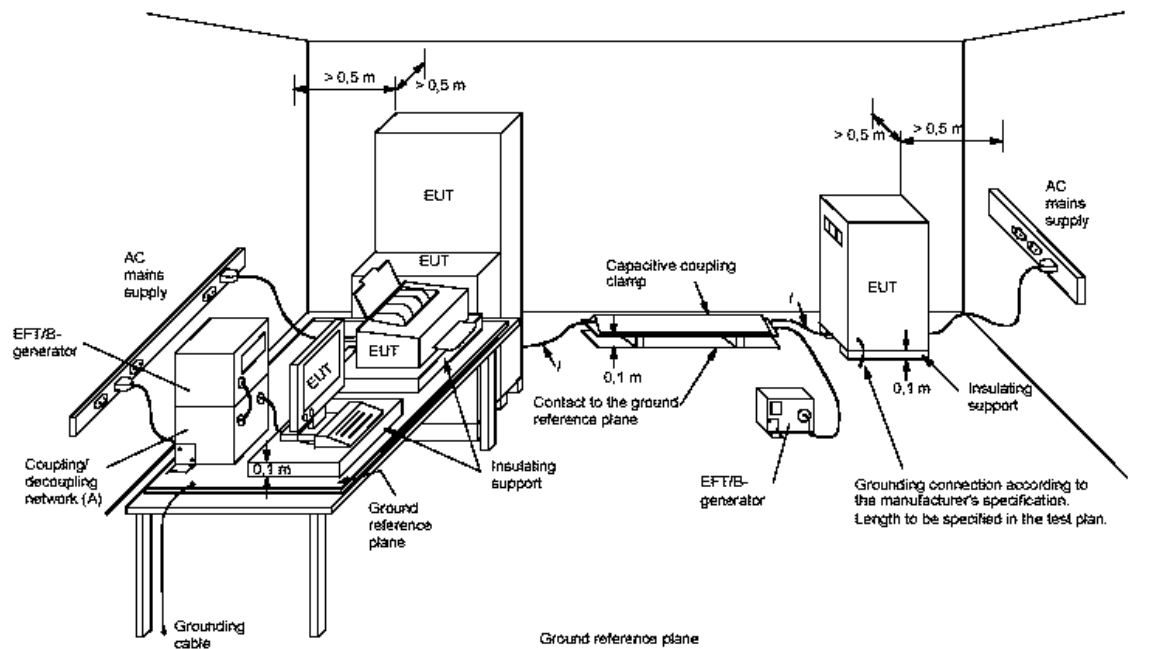

For the actual test configuration, please refer to the related item – Photographs of the Test Configuration.

NOTE: **TABLETOP EQUIPMENT**

The configuration consisted of a wooden table standing on the Ground Reference Plane and should be located 0.1m +/- 0.01m above the Ground Reference Plane. The GRP consisted of a sheet of aluminum (at least 0.25mm thick and 2.5m square) connected to the protective grounding system. A minimum distance of 0.5m was provided between the EUT and the walls of the laboratory or any other metallic structure.

FLOOR STANDING EQUIPMENT

The EUT installed in a representative system as described in section 7 of IEC 61000-4-4 and its cables, were isolated from the Ground Reference Plane by an insulating support that is 0.1-meter thick. The GRP consisted of a sheet of aluminum (at least 0.25mm thick and 2.5m square) connected to the protective grounding system.

5.7.6 TEST RESULTS

TEST MODE	Mode 1	INPUT POWER	230 Vac, 50 Hz
ENVIRONMENTAL CONDITIONS	24 deg. C, 66% RH, 1010 hPa	TESTED BY: Brian Chen	

Test Point	Polarity	Test Level (kV)	Observation	Performance Criterion
L1	+/-	1	Note	B
L2	+/-	1	Note	B
PE	+/-	1	Note	B
L1-L2-PE	+/-	1	Note	B

NOTE: The voltage of EUT was changed from 15.00V ~ 15.17V (original 15.00V) during the test, but self-recoverable after the test.

5.8 SURGE IMMUNITY TEST

5.8.1 TEST SPECIFICATION

Basic Standard:	IEC 61000-4-5
Wave-Shape:	Combination Wave 1.2/50 us Open Circuit Voltage 8 /20 us Short Circuit Current
Test Voltage:	Power Line: 0.5kV/ 1kV/ 2kV
Surge Input/ Output:	L1-L2 / L1-PE / L2-PE
Generator Source	2 ohm between networks
Impedance:	12 ohm between network and ground
Polarity:	Positive/Negative
Phase Angle:	0° /90°/180°/270°
Pulse Repetition Rate:	1 time / 20 sec.
Number of Tests:	5 positive and 5 negative at selected points

5.8.2 TEST INSTRUMENTS

DESCRIPTION & MANUFACTURER	MODEL NO.	SERIAL NO.	CALIBRATED DATE	CALIBRATED UNTIL
KeyTek, Surge Coupler/Decoupler	E551	9508350	Jun. 26, 2009	Jun. 25, 2010
Coupling Decoupling Network	CDN-UTP8	028	Jun. 29, 2009	Jun. 28, 2010
KeyTek I/O Signal Line Coupler/Decoupler	CM-I/OCD	9907177	NA	NA
Surge Cable	WE-4	SU1Cab-001	NA	NA
Surge Adapter WONPRO	WA-9	SU1ADA-002	NA	NA
Software	E500	NA	NA	NA

- NOTE:** 1. The test was performed in Surge Room.
 2. The calibration interval of the above test instruments is 12 months and the calibrations are traceable to NML/ROC and NIST/USA.

5.8.3 TEST PROCEDURE

a. For EUT power supply:

The surge is to be applied to the EUT power supply terminals via the capacitive coupling network. Decoupling networks are required in order to avoid possible adverse effects on equipment not under test that may be powered by the same lines, and to provide sufficient decoupling impedance to the surge wave. The power cord between the EUT and the coupling/decoupling networks shall be 2 meters in length (or shorter).

b. For test applied to unshielded unsymmetrically operated interconnection lines of EUT:

The surge is applied to the lines via the capacitive coupling. The coupling / decoupling networks shall not influence the specified functional conditions of the EUT. The interconnection line between the EUT and the coupling/decoupling networks shall be 2 meters in length (or shorter).

c. For test applied to unshielded symmetrically operated interconnection / telecommunication lines of EUT:

The surge is applied to the lines via gas arrestors coupling. Test levels below the ignition point of the coupling arrestor cannot be specified. The interconnection line between the EUT and the coupling/decoupling networks shall be 2 meters in length (or shorter).

5.8.4 DEVIATION FROM TEST STANDARD

No deviation

5.8.5 TEST SETUP

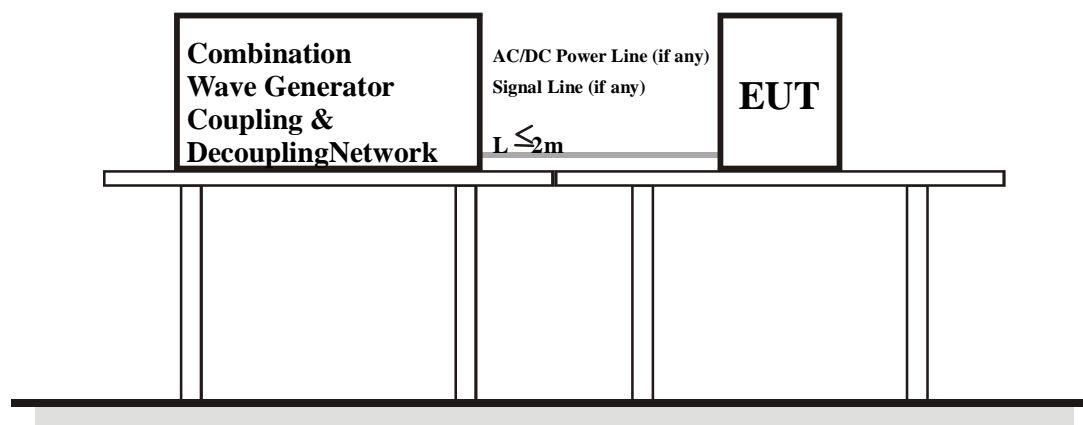

For the actual test configuration, please refer to the related item – Photographs of the Test Configuration.

5.8.6 TEST RESULTS

TEST MODE	Mode 1	INPUT POWER	230 Vac, 50 Hz
ENVIRONMENTAL CONDITIONS	26 deg. C, 71% RH, 1010 hPa	TESTED BY: Bin Cheng	

VOLTAGE (kV)	TEST POINT	POLARITY	OBSERVATION	PERFORMANCE CRITERION
0.5, 1	L1-L2	+/-	Note	A
0.5, 1, 2	L1-PE	+/-	Note	A
0.5, 1, 2	L2-PE	+/-	Note	A

NOTE: There was no change compared with the initial operation during the test.

5.9 IMMUNITY TO CONDUCTED DISTURBANCES INDUCED BY RF FIELDS (CS)

5.9.1 TEST SPECIFICATION

Basic Standard:	IEC 61000-4-6
Frequency Range:	0.15 MHz - 80 MHz
Field Strength:	3 V _{r.m.s.}
Modulation:	1 kHz Sine Wave, 80%, AM Modulation
Frequency Step:	1 % of fundamental
Coupled Cable:	Power Mains
Coupling Device:	CDN-M3 (3 wires)



5.9.2 TEST INSTRUMENTS

DESCRIPTION & MANUFACTURER	MODEL NO.	SERIAL NO.	CALIBRATED DATE	CALIBRATED UNTIL
ROHDE & SCHWARZ Signal Generator	SMY01	840490/009	Aug. 06, 2009	Aug. 05, 2010
Digital Sweep Function Generator	8120	984801	NA	NA
AR Power Amplifier	75A250AM1	312196	NA	NA
FCC Coupling Decoupling Network	FCC-801-M3 -25A	48	Jul. 24, 2009	Jul. 23, 2010
FCC Coupling Decoupling Network	FCC-801-M3 -25A	01022	Mar. 05, 2009	Mar. 04, 2010
FCC Coupling Decoupling Network	FCC-801-M2 -16A	01047	Jul. 06, 2009	Jul. 05, 2010
FISCHER CUSTOM COMMUNICATIONS EM Injection Clamp	FCC-203I	50	NA	NA
EM TEST Coupling Decoupling Network	CDN M1/32A	306508	Apr. 07, 2009	Apr. 06, 2010
FCC Coupling Decoupling Network	FCC-801-T8	02038	May 21, 2009	May 20, 2010
FCC Coupling Decoupling Network	FCC-801-T4	02031	Jun. 16, 2009	Jun. 15, 2010
FCC Coupling Decoupling Network	FCC-801-T2	02021	Mar. 05, 2009	Mar. 04, 2010
R&S Power Sensor	NRV-Z5	837878/038	Oct. 27, 2008	Oct. 26, 2009
R&S Power Sensor	NRV-Z5	837878/039	Oct. 25, 2008	Oct. 24, 2009
R&S Power Meter	NRVD	837794/040	Oct. 27, 2008	Oct. 26, 2009
Software	ADT_CS_V7. 4.2	NA	NA	NA

- NOTE:** 1. The test was performed in CS Room No. 1.
2. The calibration interval of the above test instruments is 12 months and the calibrations are traceable to NML/ROC and NIST/USA.

5.9.3 TEST PROCEDURE

- a. The EUT shall be tested within its intended operating and climatic conditions.
- b. An artificial hand was placed on the hand-held accessory and connected to the ground reference plane.
- c. The test shall be performed with the test generator connected to each of the coupling and decoupling devices in turn, while the other non-excited RF input ports of the coupling devices are terminated by a 50-ohm load resistor.
- d. The frequency range is swept from 150 kHz to 80 MHz, using the signal level established during the setting process and with a disturbance signal of 80 % amplitude. The signal is modulated with a 1 kHz sine wave, pausing to adjust the RF signal level or the switch coupling devices as necessary. Where the frequency is swept incrementally, the step size shall not exceed 1 % of the preceding frequency value.
- e. The dwell time of the amplitude modulated carrier at each frequency shall not be less than the time necessary for the EUT to be exercised and to respond, but shall in no case be less than 0,5 s. The sensitive frequencies (e.g. clock frequencies) shall be analyzed separately.
- f. Attempts should be made to fully exercise the EUT during testing, and to fully interrogate all exercise modes selected for susceptibility.

5.9.4 DEVIATION FROM TEST STANDARD

No deviation

5.9.5 TEST SETUP

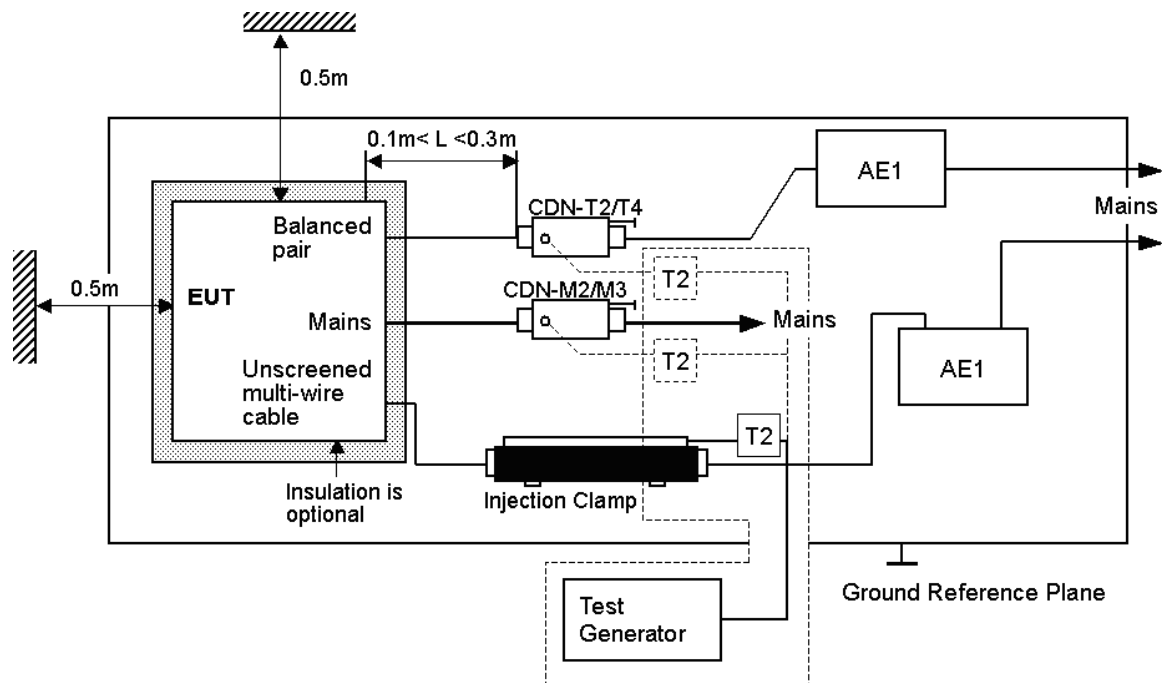

NOTE: The EUT clearance from any metallic obstacles shall be at least 0.5m.
 All non-excited input ports of the CDNs shall be terminated by 50Ω loads.

For the actual test configuration, please refer to the related item – Photographs of the Test Configuration.

NOTE:

The equipment to be tested is placed on an insulating support of 0.1 meters height above a ground reference plane. All relevant cables shall be provided with the appropriate coupling and decoupling devices at a distance between 0.1 meters and 0.3 meters from the projected geometry of the EUT on the ground reference plane.

5.9.6 TEST RESULTS

TEST MODE	Mode 1	INPUT POWER	230 Vac, 50 Hz
ENVIRONMENTAL CONDITIONS	25 deg. C, 73% RH, 1010 hPa	TESTED BY: Brian Chen	

Frequency (MHz)	Field Strength (V _{r.m.s.})	Cable	Injection Method	Observation	Performance Criterion
0.15 – 80	3	AC power line	CDN-M3	Note	A

NOTE: There was no change compared with the initial operation during the test.

5.10 POWER FREQUENCY MAGNETIC FIELD IMMUNITY TEST

5.10.1 TEST SPECIFICATION

For EN 55024 only

Basic Standard:	IEC 61000-4-8
Frequency Range:	50 Hz
Field Strength:	1 A/m
Observation Time:	1 minute
Inductance Coil:	Rectangular type, 1 m x 1 m

5.10.2 TEST INSTRUMENTS

DESCRIPTION & MANUFACTURER	MODEL NO.	SERIAL NO.	CALIBRATED DATE	CALIBRATED UNTIL
HAEFELY Magnetic Field Tester	MAG 100.1	083794-06	NA	NA
COMBINOVA Magnetic Field Meter	MFM10	224	Feb. 23, 2009	Feb. 22, 2010

- NOTE:** 1. The test was performed in EMS Room No. 1.
 2. The calibration interval of the above test instruments is 12 months and the calibrations are traceable to NML/ROC and NIST/USA.

5.10.3 TEST PROCEDURE

- The equipment is configured and connected to satisfy its functional requirements.
- The power supply, input and output circuits shall be connected to the sources of power supply, control and signal.
- The cables supplied or recommended by the equipment manufacturer shall be used. 1 meter of all cables used shall be exposed to the magnetic field.

5.10.4 DEVIATION FROM TEST STANDARD

No deviation

5.10.5 TEST SETUP

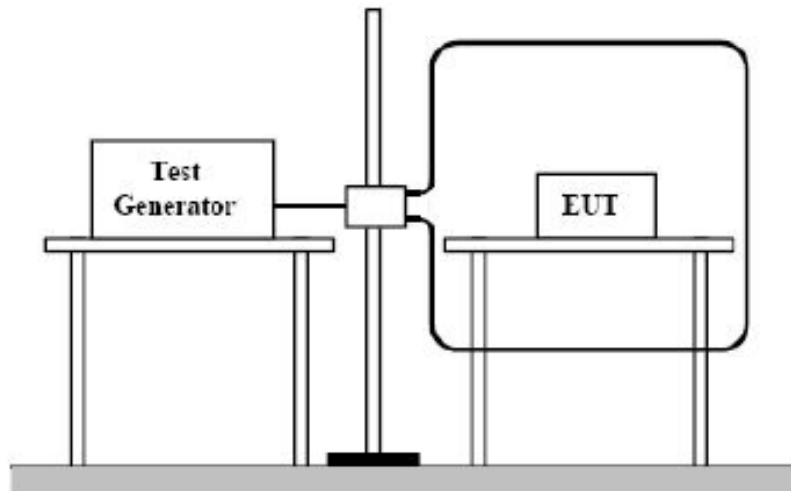

For the actual test configuration, please refer to the related item – Photographs of the Test Configuration.

NOTE:

TABLETOP EQUIPMENT

The equipment shall be subjected to the test magnetic field by using the induction coil of standard dimension (1 m x 1 m). The induction coil shall then be rotated by 90 degrees in order to expose the EUT to the test field with different orientations.

FLOOR-STANDING EQUIPMENT

The equipment shall be subjected to the test magnetic field by using induction coils of suitable dimensions. The test shall be repeated by moving and shifting the induction coils, in order to test the whole volume of the EUT for each orthogonal direction. The test shall be repeated with the coil shifted to different positions along the side of the EUT, in steps corresponding to 50 % of the shortest side of the coil. The induction coil shall then be rotated by 90 degrees in order to expose the EUT to the test field with different orientations.

5.10.6 TEST RESULTS

TEST MODE	Mode 1	INPUT POWER	230 Vac, 50 Hz
ENVIRONMENTAL CONDITIONS	26 deg. C, 68% RH, 1010 hPa	TESTED BY: Brian Chen	

Direction	Field Strength (A/m)	Observation	Performance Criterion
X - Axis	1	Note	A
Y - Axis	1	Note	A
Z - Axis	1	Note	A

NOTE: There was no change compared with the initial operation during the test.



5.11 VOLTAGE DIP/SHORT INTERRUPTIONS/VOLTAGE VARIATIONS (DIP) IMMUNITY TEST

5.11.1 TEST SPECIFICATION

Basic Standard:	IEC 61000-4-11
Test Duration Time:	Minimum three test events in sequence
Interval between Event:	Minimum ten seconds
Phase Angle:	0° & 180°
Test Cycle:	3 times

5.11.2 TEST INSTRUMENTS

DESCRIPTION & MANUFACTURER	MODEL NO.	SERIAL NO.	CALIBRATED DATE	CALIBRATED UNTIL
HAEFELY Mains Interference Simulator	PLINE1610	083690-17	May 20, 2009	May 19, 2010

- NOTE:** 1. The test was performed in EMS Room No. 1.
2. The calibration interval of the above test instruments is 12 months and the calibrations are traceable to NML/ROC and NIST/USA.

5.11.3 TEST PROCEDURE

The EUT shall be tested for each selected combination of test levels and duration with a sequence of three dips/interruptions with intervals of 10 s minimum (between each test event). Each representative mode of operation shall be tested. Abrupt changes in supply voltage shall occur at zero crossings of the voltage waveform.

5.11.4 DEVIATION FROM TEST STANDARD

No deviation

5.11.5 TEST SETUP

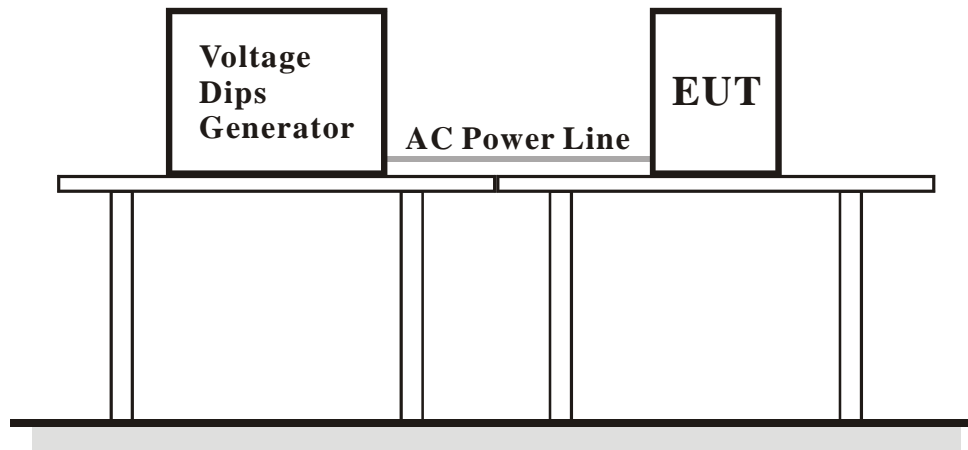

For the actual test configuration, please refer to the related item – Photographs of the Test Configuration.

5.11.6 TEST RESULTS – FOR EN 61204-3

TEST MODE	Mode 1	INPUT POWER	230 Vac, 50 Hz/ 100 Vac, 50 Hz
ENVIRONMENTAL CONDITIONS	26 deg. C, 69% RH, 1010 hPa	TESTED BY: Brian Chen	

Input Power for testing: 230 Vac, 50 Hz			
VOLTAGE % REDUCTION	DURATIONS (ms)	OBSERVATION	PERFORMANCE CRITERION
30	10	Note (1)	A
60	100	Note (1)	A
>95	5000	Note (2)	B

Input Power for testing: 100 Vac, 50 Hz			
VOLTAGE % REDUCTION	DURATIONS (ms)	OBSERVATION	PERFORMANCE CRITERION
30	10	Note (1)	A
60	100	Note (2)	B
>95	5000	Note (2)	B

NOTE: (1) There was no change compared with the initial operation during the test.
(2) The EUT reset during the test.

5.11.7 TEST RESULTS – FOR EN 55024

TEST MODE	Mode 1	INPUT POWER	230 Vac, 50 Hz/ 100 Vac, 50 Hz
ENVIRONMENTAL CONDITIONS	26 deg. C, 69% RH, 1010 hPa	TESTED BY: Brian Chen	

Input Power for testing: 230Vac, 50 Hz			
VOLTAGE % REDUCTION	DURATIONS (period)	OBSERVATION	PERFORMANCE CRITERION
>95	0.5	Note (1)	A
30	25	Note (1)	A
>95	250	Note (2)	B

Input Power for testing: 100Vac, 50 Hz			
VOLTAGE % REDUCTION	DURATIONS (period)	OBSERVATION	PERFORMANCE CRITERION
>95	0.5	Note (1)	A
30	25	Note (2)	B
>95	250	Note (2)	B

NOTES: (1) There was no change compared with the initial operation during the test.
(2) The EUT reset during the test.

6 PHOTOGRAPHS OF THE TEST CONFIGURATION

CONDUCTED EMISSION TEST (For Mode 1, Mode 3 & Mode 5)



CONDUCTED EMISSION TEST (For Mode 2 & Mode 4)



RADIATED EMISSION TEST (For Mode 1)

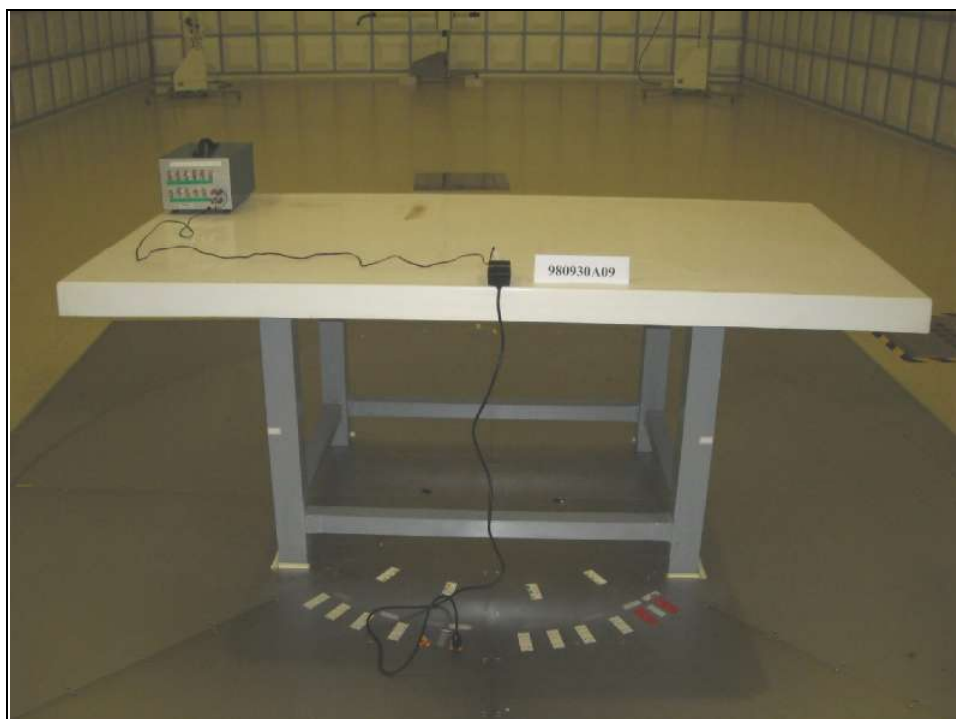

RADIATED EMISSION TEST (For Mode 2)

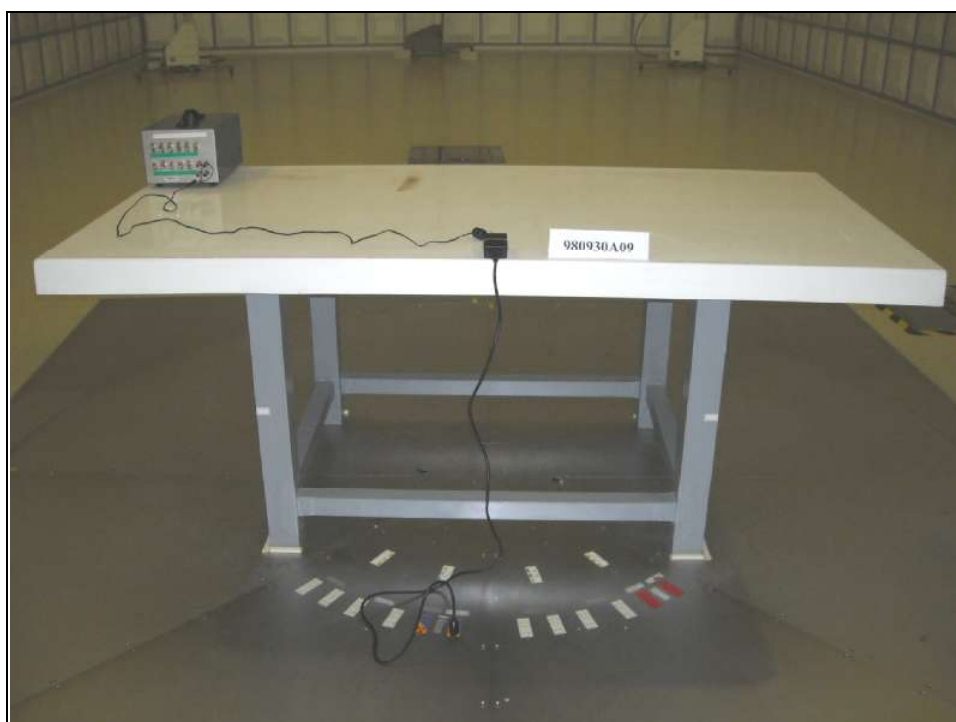

HARMONICS EMISSION TEST & VOLTAGE FLUCTUATIONS AND FLICKER TEST



ESD TEST

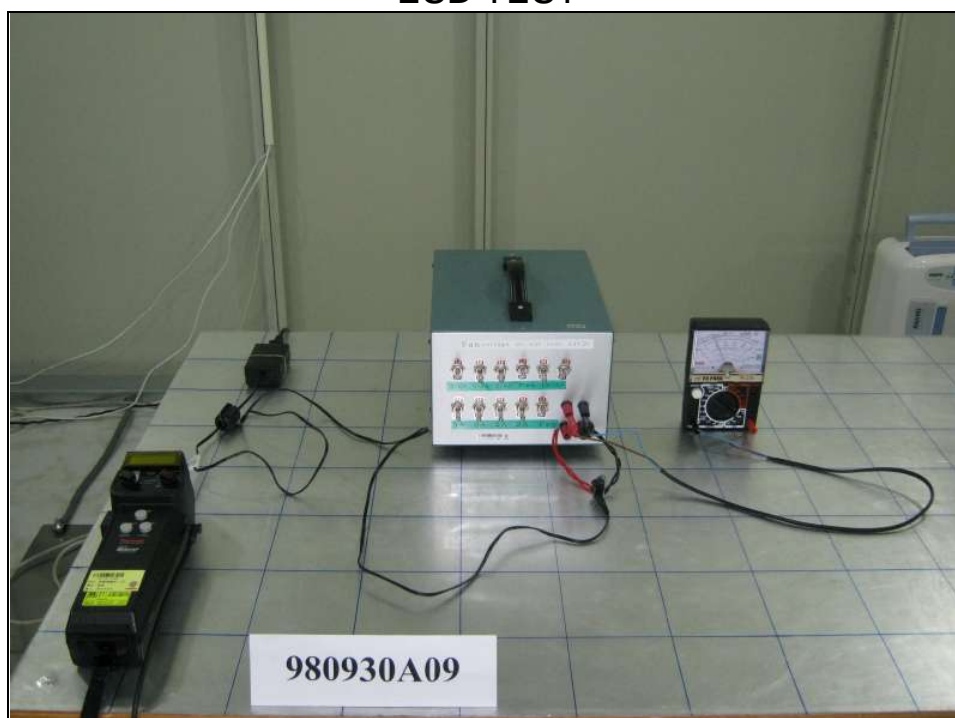

ESD TEST POINT



ESD TEST POINT



RS TEST

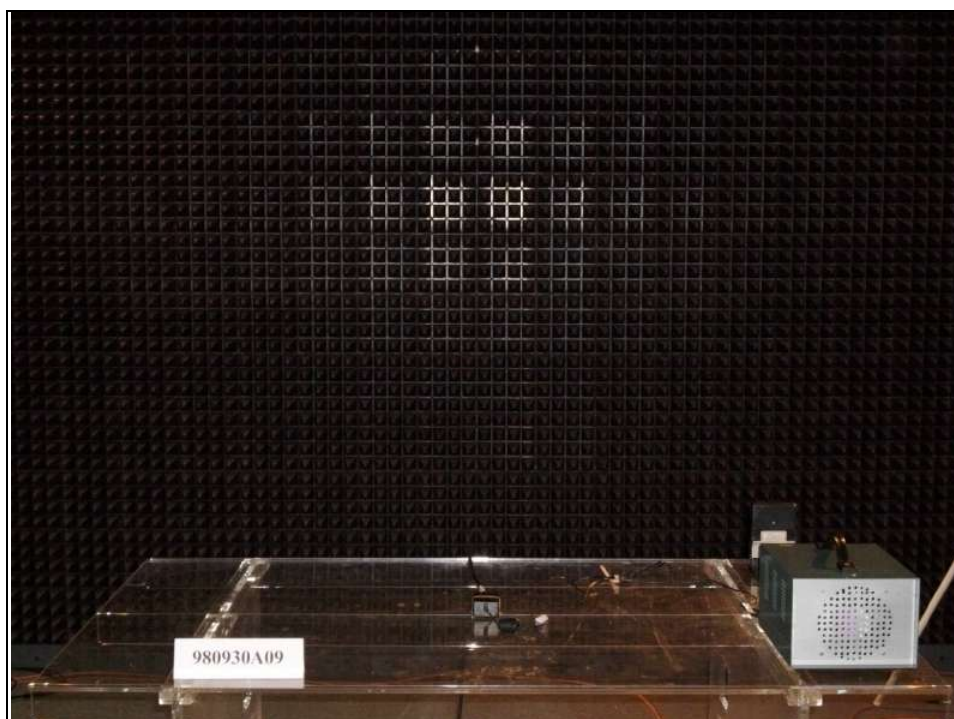
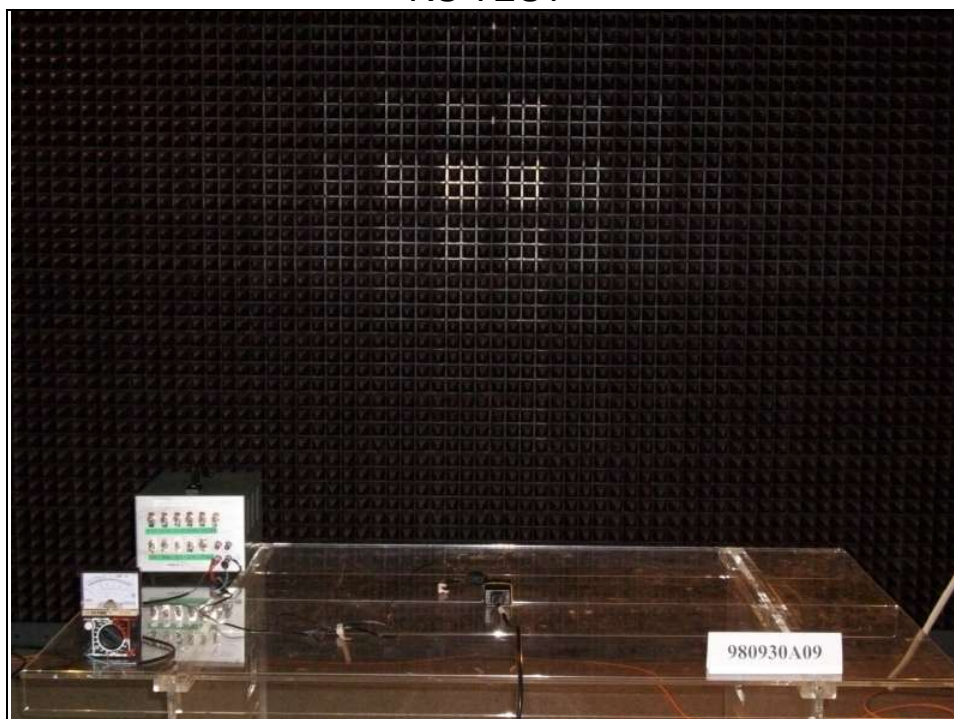

EFT TEST

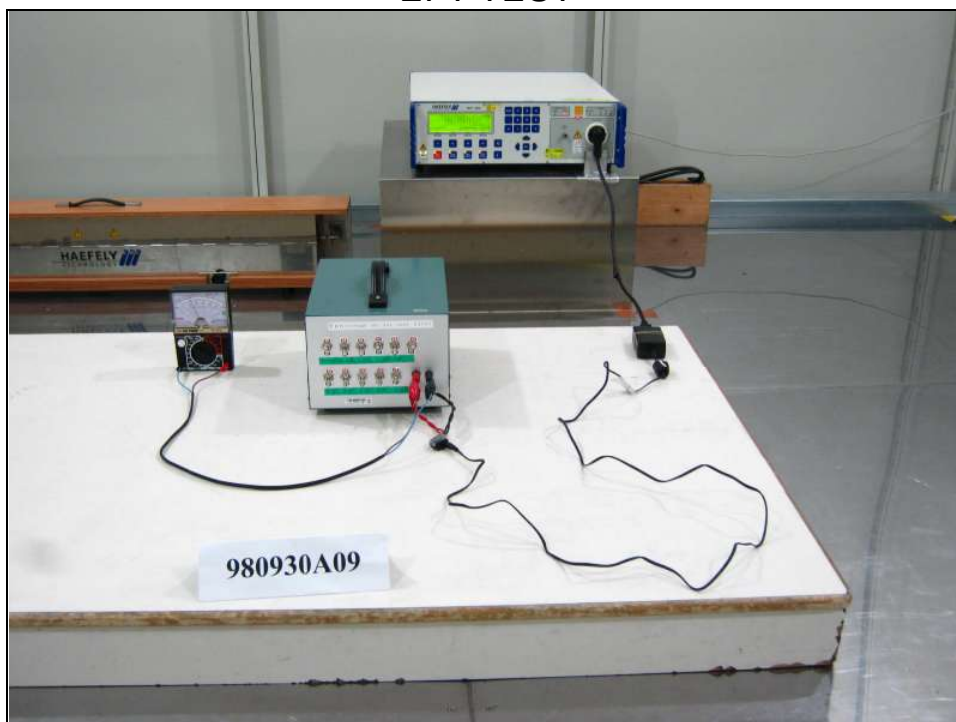

SURGE TEST



CONDUCTED SUSCEPTIBILITY TEST

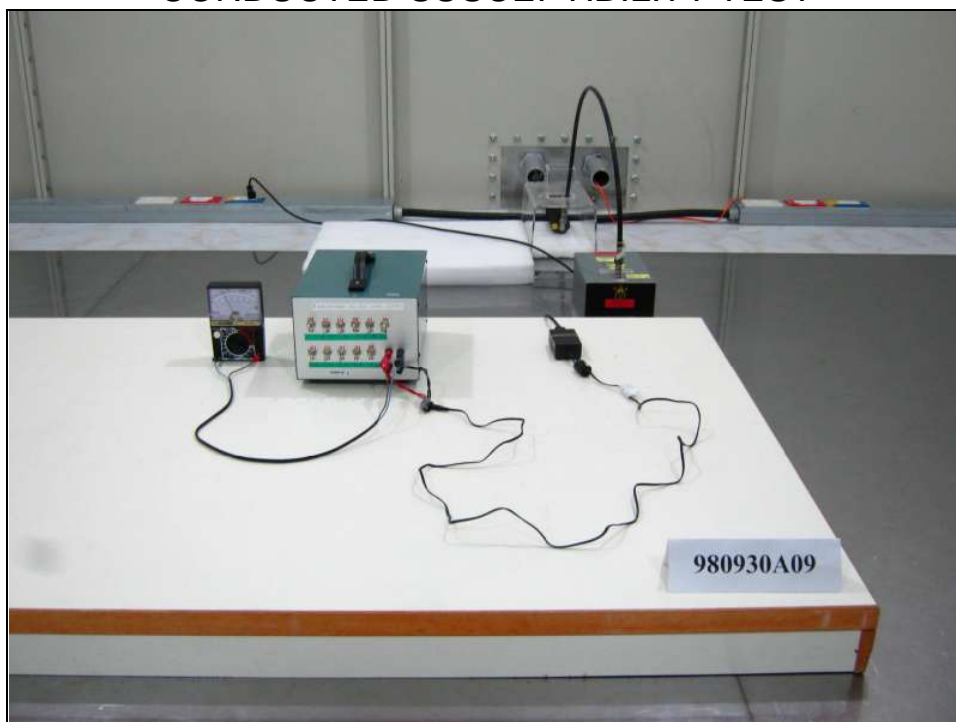

POWER-FREQUENCY MAGNETIC FIELDS TEST – *For EN 55024 only*



VOLTAGE DIPS AND INTERRUPTIONS TEST





7 APPENDIX - INFORMATION ON THE TESTING LABORATORIES

We, Bureau Veritas Consumer Products Services (H.K.) Ltd., Taoyuan Branch, were founded in 1988 to provide our best service in EMC, Radio, Telecom and Safety consultation. Our laboratories are accredited and approved according to ISO/IEC 17025.

Copies of accreditation certificates of our laboratories obtained from approval agencies can be downloaded from our web site: www.adt.com.tw/index.5/phtml. If you have any comments, please feel free to contact us at the following:

Linko EMC/RF Lab:

Tel: 886-2-26052180

Fax: 886-2-26051924

Hsin Chu EMC/RF Lab:

Tel: 886-3-5935343

Fax: 886-3-5935342

Hwa Ya EMC/RF/Safety/Telecom Lab:

Tel: 886-3-3183232

Fax: 886-3-3185050

Email: service@adt.com.tw

Web Site: www.adt.com.tw

The address and road map of all our labs can be found in our web site also.

--- END ---